

PRODUCT PARTNUMBER
10146065-XXXXLF

PARTNO &
DATECODE

#AI IDENTIFIER

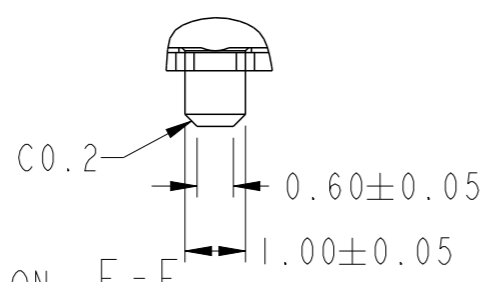
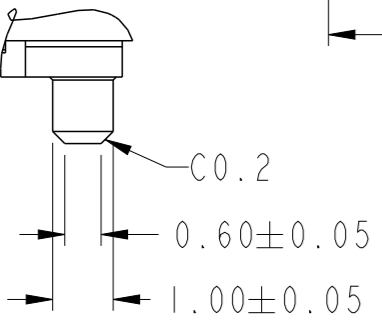
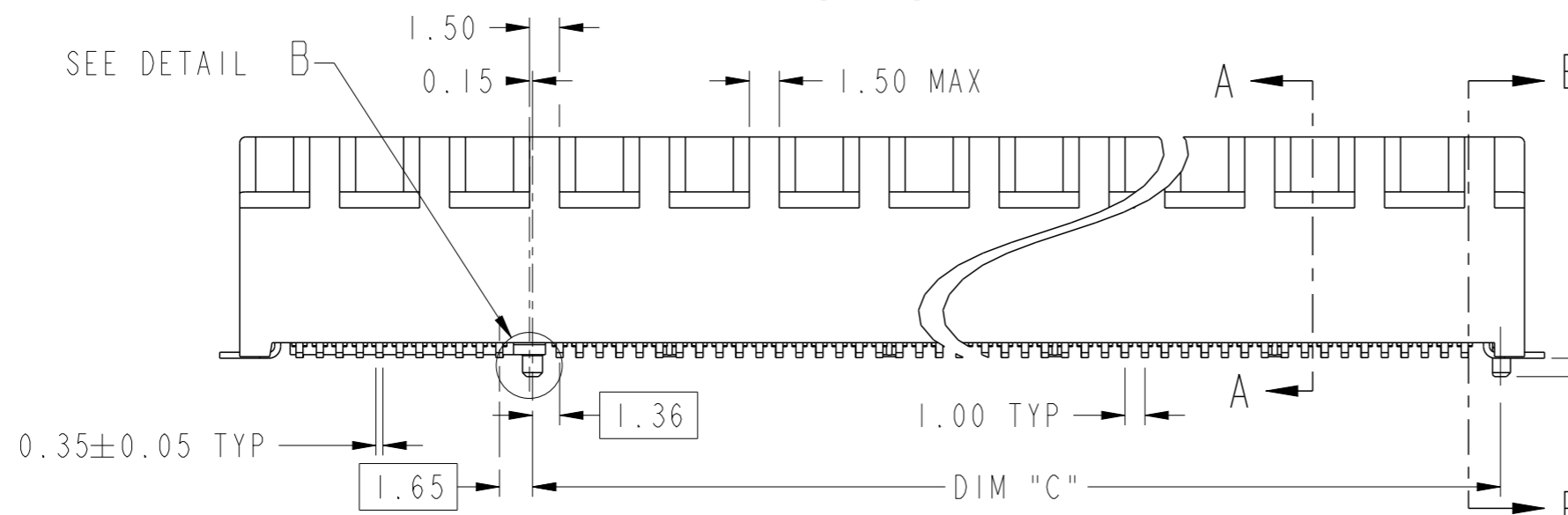
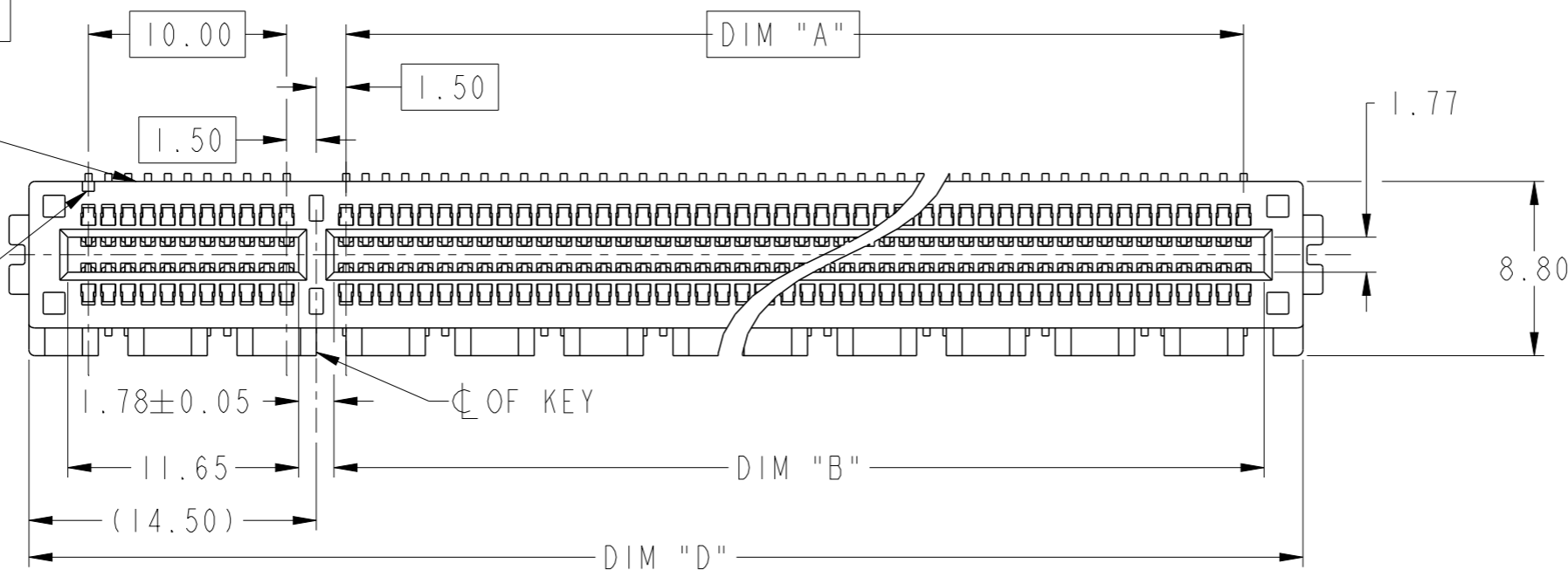

DETAIL B
SCALE 8:1

SECTION E-E
SCALE 8:1

SECTION E-E
SCALE 3:1

spec ref	-	dr	Cheong, Matthe	2017/11/06	projection	MM	size	A3	scale	3:1	
tolerance std	ISO 406 ISO 1101	eng	Cheong, Matthe	2018/07/19			ecn no	ELX-S-30728-1	rel level	Released	
TOLERANCES UNLESS OTHERWISE SPECIFIED		chr	-	app			Koon-Poh Tay	2018/07/26		product family	PCI express
surface	ISO 1302	linear	0.X	±0.30	Amphenol FCI		PCI Express 4.0	dwg no	10146065	rev	E
			0.XX	±0.20	www.fci.com		SMT Type				
		angular	0°	±2°	cat. no.	-	Product - Customer Drw	sheet 1 of 4			

Amphenol FCI

© 2016 AFCI

CONNECTOR LINK WIDTH	POSITION	N	DIM "G"	DIM "F"	PIN "L"
X1	36	6	8.15	6.00	B17
X4	64	20	22.15	20.00	B31
X8	98	37	39.15	37.00	B48
X16	164	70	72.15	70.00	B81



← I/O PANEL DIRECTION
PRIMARY (COMPONENT) SIDE



I/O PANEL DIRECTION →
SECONDARY (SOLDER) SIDE

Amphenol FCI
© 2016 AFCI

- NO TIE BAR PERMITTED FROM CARD EDGE TO LEADING EDGE OF PAD FOR PIN AI AND PIN "L".
- CHAMFER EDGES MUST BE FREE OF CUTTING BURRS.
- TOLERANCE : ± 0.13

spec ref	-	dr	Cheong, Matthe	2017/11/06	projection	MM	size	A3	scale	2:1	
tolerance std	ISO 406 ISO 1101	eng	Cheong, Matthe	2018/07/19			ecn no	ELX-S-30728-1			
TOLERANCES UNLESS OTHERWISE SPECIFIED		chr	-	-			product family	PCI express	rel level	Released	
surface	linear	appr	Koon-Poh Tay	2018/07/26	PCI Express 4.0		dwg no	10146065		rev	E
ISO 1302	angular	www.fci.com		cat. no.	Product - Customer Drw		sheet 2 of 4				



RECOMMENDED PCB LAYOUT, PAD TYPE

POSITION	DIMENSIONS							
	A	B ^{+0.15} / _{-0.05}	C ±0.10	D ±0.23	E ±0.20	H ±0.10	J	K ±0.10
36	6.00	7.65	9.15	25.00	27.00	28.00	6.00	9.15
64	20.00	21.65	23.15	39.00	41.00	42.00	20.00	23.15
98	37.00	38.65	40.15	56.00	58.00	59.00	37.00	40.15
164	70.00	71.65	73.15	89.00	91.00	92.00	70.00	73.15
98 (SEE NOTE)	37.00	38.65	40.15	56.00	56.60	59.00	37.00	40.15
164 (SEE NOTE)	70.00	71.65	73.15	89.00	89.60	92.00	70.00	73.15

spec ref	-	dr	Cheong, Matthe	2017/11/06	projection	MM	size	A3	scale	4:1	
tolerance std	ISO 406 ISO 1101	TOLERANCES UNLESS OTHERWISE SPECIFIED			eng	Cheong, Matthe	2018/07/19	ecn no	ELX-S-30728-1		
surface	-	chr	-	-	appr	Koon-Poh Tay	2018/07/26	product family	PCI express	rel level	Released
ISO 1302	linear	0.X	±0.30	Amphenol FCi	PCI Express 4.0			dwg no	10146065		rev
		0.XX	±0.20		SMT Type						
	angular	0°	±2°		www.fci.com						
cat. no.					-		Product - Customer Drw			sheet 3 of 4	

PRODUCT NUMBER CODE

10146065- LF

HOUSING COLOR

I: BLACK

HOLDDOWN CLIP

0: NORMAL
I: SHORTER (BY 0.7MM PER SIDE)

CONTACT AREA PLATING

1: 30u" Au
2: 15u" Au

NO. OF POSITION

0: 36 POSITIONS
1: 64 POSITIONS
2: 98 POSITIONS
3: 164 POSITIONS

PACKAGING OPTIONS

A: HARD TRAY (DIM: 323 x 136 x 19) WITH KAPTON TAPE, 22MM (164 POS)
B: HARD TRAY (DIM: 323 x 136 x 19) WITH KAPTON TAPE, 86.5MM (164 POS) 
Q: HARD TRAY (DIM: 323 x 136 x 19) (98 & 164 POS)
C: SOFT TRAY (317.5 x 235 x 18) WITH PICK-UP CAP (36 & 64 POS)
T: SOFT TRAY (317.5 x 235 x 18) WITH KAPTON TAPE, 22MM (36 & 64 POS)
W: HARD TRAY (DIM: 330 x 235 x 19.3) WITH KAPTON TAPE, 30MM (98 & 164 POS)
X: HARD TRAY (DIM: 330 x 235 x 19.3) WITH PICK UP CAP (98 & 164 POS)
Y: HARD TRAY (DIM: 330 x 235 x 19.3) WITH KAPTON TAPE, 22MM (98 & 164 POS)
Z: HARD TRAY (DIM: 330 x 235 x 19.3) WITH KAPTON TAPE, 8.56MM (164 POS)



NOTES:

- MATERIAL:
HOUSING: LCP
CONTACT: COPPER ALLOY.
HOLDDOWN CLIP: COPPER ALLOY
- PLATING:
CONTACT: UNDERPLATE: 50u" NICKEL OVER ALL.
SOLDER AREA: 100u" TIN (LEAD FREE).
MATING AREA: SEE PRODUCT NUMBER CODE.
HOLDDOWN CLIP: 100u" TIN OVER 50 u" NICKEL.
- PRODUCT SPECIFICATION: GS-12-1406
- PRODUCT MEETS EUROPEAN UNION DIRECTIVES AND OTHER COUNTRY REGULATIONS AS DESCRIBED IN GS-47-004.
- DATE CODE "MMDDYYL", MMDDYY IS ASSEMBLY DATE. L IS AFCI PRODUCTION SITE.
- THE HOUSING WILL WITHSTAND EXPOSURE TO 260° PEAK TEMPERATURE FOR 10 SECONDS IN A CONVECTION, INFRA-RED OR VAPOR PHASE REFLOW OVEN.
- PARTNO: 10146065-**2*1LF & 10146065-**3*1LF, ARE OPTIONS WITH SHORTER HOLDDOWN CLIP FLAT AND PAD LENGTH

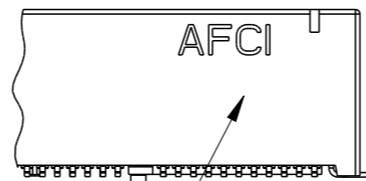

DATA CODE & PARTNO

POSITION OF KAPTON TAPE

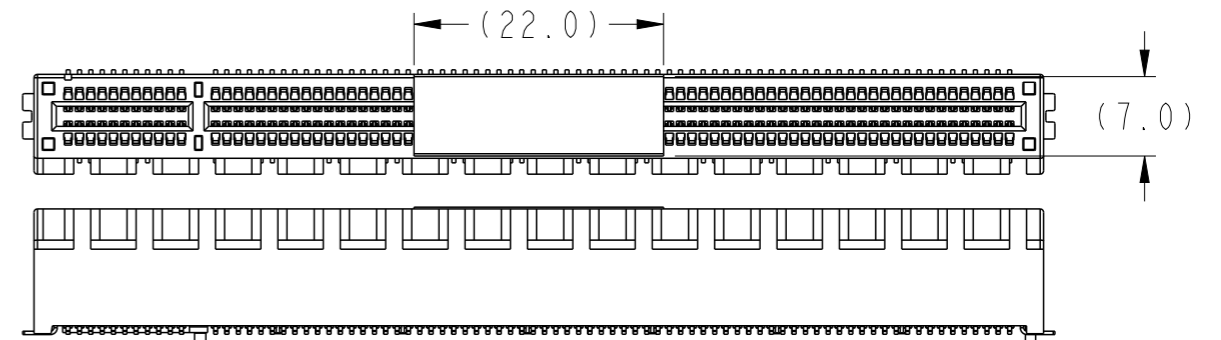

POSITION OF PICK UP CAP

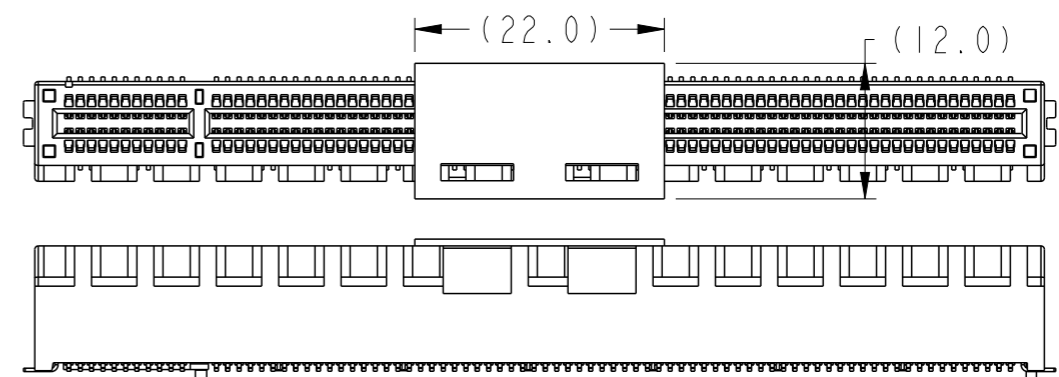

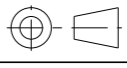
spec ref	-	dr	Cheong, Matthe	2017/11/06	projection	MM	size	A3	scale	2:1
tolerance std	ISO 406 ISO 1101	eng	Cheong, Matthe	2018/07/19		← →	ecn no	ELX-S-30728-1	rel level	Released
TOLERANCES UNLESS OTHERWISE SPECIFIED		chr	-	-						
surface	linear	appr	Koon-Poh Tay	2018/07/26	product family	PCI express	rel level	Released	dwg no	10146065
	0.X ±0.30				Amphenol FCI	PCI Express 4.0			rev	E
	0.XX ±0.20				www.fci.com	SMT Type				
	0.XXX ±0.1				cat. no.	Product - Customer Drw			sheet 4 of 4	
ISO 1302	angular									
	0° ±2°									

Компания «Life Electronics» занимается поставками электронных компонентов импортного и отечественного производства от производителей и со складов крупных дистрибьюторов Европы, Америки и Азии.

С конца 2013 года компания активно расширяет линейку поставок компонентов по направлению коаксиальный кабель, кварцевые генераторы и конденсаторы (керамические, пленочные, электролитические), за счёт заключения дистрибьюторских договоров

Мы предлагаем:

- Конкурентоспособные цены и скидки постоянным клиентам.
- Специальные условия для постоянных клиентов.
- Подбор аналогов.
- Поставку компонентов в любых объемах, удовлетворяющих вашим потребностям.
- Приемлемые сроки поставки, возможна ускоренная поставка.
- Доставку товара в любую точку России и стран СНГ.
- Комплексную поставку.
- Работу по проектам и поставку образцов.
- Формирование склада под заказчика.
- Сертификаты соответствия на поставляемую продукцию (по желанию клиента).
- Тестирование поставляемой продукции.
- Поставку компонентов, требующих военную и космическую приемку.
- Входной контроль качества.
- Наличие сертификата ISO.

В составе нашей компании организован Конструкторский отдел, призванный помогать разработчикам, и инженерам.

Конструкторский отдел помогает осуществить:

- Регистрацию проекта у производителя компонентов.
- Техническую поддержку проекта.
- Защиту от снятия компонента с производства.
- Оценку стоимости проекта по компонентам.
- Изготовление тестовой платы монтаж и пусконаладочные работы.



Тел: +7 (812) 336 43 04 (многоканальный)
Email: org@lifeelectronics.ru