

MC74HC00A

Quad 2-Input NAND Gate

High-Performance Silicon-Gate CMOS

The MC74HC00A is identical in pinout to the LS00. The device inputs are compatible with Standard CMOS outputs; with pullup resistors, they are compatible with LSTTL outputs.

Features

- Output Drive Capability: 10 LSTTL Loads
- Outputs Directly Interface to CMOS, NMOS and TTL
- Operating Voltage Range: 2 to 6 V
- Low Input Current: 1 μ A
- High Noise Immunity Characteristic of CMOS Devices
- In Compliance With the JEDEC Standard No. 7 A Requirements
- Chip Complexity: 32 FETs or 8 Equivalent Gates
- NLV Prefix for Automotive and Other Applications Requiring Unique Site and Control Change Requirements; AEC-Q100 Qualified and PPAP Capable
- These Devices are Pb-Free, Halogen Free and are RoHS Compliant

LOGIC DIAGRAM

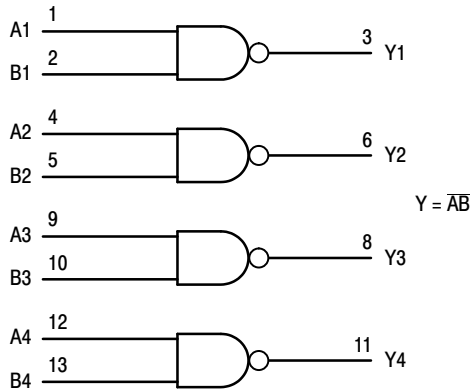

$$Y = \overline{AB}$$

PIN 14 = V_{CC}
PIN 7 = GND

Pinout: 14-Lead Packages (Top View)

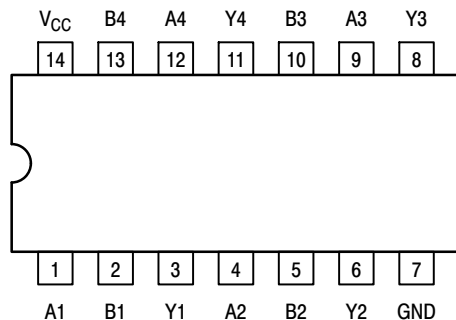

ON Semiconductor®

<http://onsemi.com>

MARKING DIAGRAMS

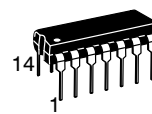

PDIP-14
N SUFFIX
CASE 646

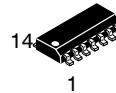
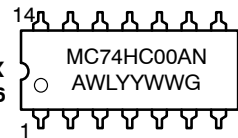

SOIC-14
D SUFFIX
CASE 751A

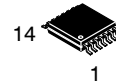
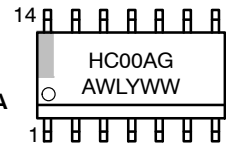

TSSOP-14
DT SUFFIX
CASE 948G

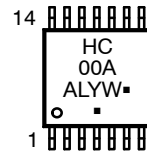

A = Assembly Location
L, WL = Wafer Lot
Y, YY = Year
W, WW = Work Week
G or ■ = Pb-Free Package

(Note: Microdot may be in either location)

FUNCTION TABLE

| Inputs | | Output |
|--------|---|--------|
| A | B | Y |
| L | L | H |
| L | H | H |
| H | L | H |
| H | H | L |

ORDERING INFORMATION

See detailed ordering and shipping information in the package dimensions section on page 2 of this data sheet.

MC74HC00A

MAXIMUM RATINGS

| Symbol | Parameter | Value | Unit |
|-----------|---|-------------------------|------|
| V_{CC} | DC Supply Voltage (Referenced to GND) | - 0.5 to + 7.0 | V |
| V_{in} | DC Input Voltage (Referenced to GND) | - 0.5 to $V_{CC} + 0.5$ | V |
| V_{out} | DC Output Voltage (Referenced to GND) | - 0.5 to $V_{CC} + 0.5$ | V |
| I_{in} | DC Input Current, per Pin | ± 20 | mA |
| I_{out} | DC Output Current, per Pin | ± 25 | mA |
| I_{CC} | DC Supply Current, V_{CC} and GND Pins | ± 50 | mA |
| P_D | Power Dissipation in Still Air, Plastic DIP† SOIC Package† TSSOP Package† | 750 500 450 | mW |
| T_{stg} | Storage Temperature | - 65 to + 150 | °C |
| T_L | Lead Temperature, 1 mm from Case for 10 Seconds Plastic DIP, SOIC or TSSOP Package | 260 | °C |

This device contains protection circuitry to guard against damage due to high static voltages or electric fields. However, precautions must be taken to avoid applications of any voltage higher than maximum rated voltages to this high-impedance circuit. For proper operation, V_{in} and V_{out} should be constrained to the range $GND \leq (V_{in} \text{ or } V_{out}) \leq V_{CC}$. Unused inputs must always be tied to an appropriate logic voltage level (e.g., either GND or V_{CC}). Unused outputs must be left open.

Stresses exceeding Maximum Ratings may damage the device. Maximum Ratings are stress ratings only. Functional operation above the Recommended Operating Conditions is not implied. Extended exposure to stresses above the Recommended Operating Conditions may affect device reliability.

†Derating — Plastic DIP: - 10 mW/°C from 65° to 125°C
SOIC Package: - 7 mW/°C from 65° to 125°C
TSSOP Package: - 6.1 mW/°C from 65° to 125°C

RECOMMENDED OPERATING CONDITIONS

| Symbol | Parameter | Min | Max | Unit |
|-------------------|--|--|-------------------------|------|
| V_{CC} | DC Supply Voltage (Referenced to GND) | 2.0 | 6.0 | V |
| V_{in}, V_{out} | DC Input Voltage, Output Voltage (Referenced to GND) | 0 | V_{CC} | V |
| T_A | Operating Temperature, All Package Types | - 55 | + 125 | °C |
| t_r, t_f | Input Rise and Fall Time (Figure 1) | $V_{CC} = 2.0 \text{ V}$ $V_{CC} = 4.5 \text{ V}$ $V_{CC} = 6.0 \text{ V}$ | 0 1000 500 400 | ns |

ORDERING INFORMATION

| Device | Package | Shipping† |
|------------------|-----------------------|--------------------|
| MC74HC00ANG | PDIP-14 (Pb-Free) | 25 Units / Rail |
| MC74HC00ADG | SOIC-14 (Pb-Free) | 55 Units / Rail |
| MC74HC00ADR2G | SOIC-14 (Pb-Free) | 2500 / Tape & Reel |
| MC74HC00ADTR2G | TSSOP-14 (Pb-Free) | 2500 / Tape & Reel |
| NLV74HC00ADG* | SOIC-14 (Pb-Free) | 55 Units / Rail |
| NLV74HC00ADR2G* | SOIC-14 (Pb-Free) | 2500 / Tape & Reel |
| NLV74HC00ADTR2G* | TSSOP-14 (Pb-Free) | 2500 / Tape & Reel |
| NLV74HC00ANG* | PDIP-14 (Pb-Free) | 25 Units / Rail |

†For information on tape and reel specifications, including part orientation and tape sizes, please refer to our Tape and Reel Packaging Specifications Brochure, BRD8011/D.

*NLV Prefix for Automotive and Other Applications Requiring Unique Site and Control Change Requirements; AEC-Q100 Qualified and PPAP Capable

MC74HC00A

DC CHARACTERISTICS (Voltages Referenced to GND)

| Symbol | Parameter | Condition | V _{CC} V | Guaranteed Limit | | | Unit |
|-----------------|--|---|----------------------|------------------|-------|--------|------|
| | | | | -55 to 25°C | ≤85°C | ≤125°C | |
| V _{IH} | Minimum High-Level Input Voltage | V _{out} = 0.1V or V _{CC} - 0.1V I _{out} ≤ 20μA | 2.0 | 1.50 | 1.50 | 1.50 | V |
| | | | 3.0 | 2.10 | 2.10 | 2.10 | |
| | | | 4.5 | 3.15 | 3.15 | 3.15 | |
| | | | 6.0 | 4.20 | 4.20 | 4.20 | |
| V _{IL} | Maximum Low-Level Input Voltage | V _{out} = 0.1V or V _{CC} - 0.1V I _{out} ≤ 20μA | 2.0 | 0.50 | 0.50 | 0.50 | V |
| | | | 3.0 | 0.90 | 0.90 | 0.90 | |
| | | | 4.5 | 1.35 | 1.35 | 1.35 | |
| | | | 6.0 | 1.80 | 1.80 | 1.80 | |
| V _{OH} | Minimum High-Level Output Voltage | V _{in} = V _{IH} or V _{IL} I _{out} ≤ 20μA | 2.0 | 1.9 | 1.9 | 1.9 | V |
| | | | 4.5 | 4.4 | 4.4 | 4.4 | |
| | | | 6.0 | 5.9 | 5.9 | 5.9 | |
| | | V _{in} = V _{IH} or V _{IL} I _{out} ≤ 2.4mA I _{out} ≤ 4.0mA I _{out} ≤ 5.2mA | 3.0 | 2.48 | 2.34 | 2.20 | |
| | | | 4.5 | 3.98 | 3.84 | 3.70 | |
| | | | 6.0 | 5.48 | 5.34 | 5.20 | |
| V _{OL} | Maximum Low-Level Output Voltage | V _{in} = V _{IH} or V _{IL} I _{out} ≤ 20μA | 2.0 | 0.1 | 0.1 | 0.1 | V |
| | | | 4.5 | 0.1 | 0.1 | 0.1 | |
| | | | 6.0 | 0.1 | 0.1 | 0.1 | |
| | | V _{in} = V _{IH} or V _{IL} I _{out} ≤ 2.4mA I _{out} ≤ 4.0mA I _{out} ≤ 5.2mA | 3.0 | 0.26 | 0.33 | 0.40 | |
| | | | 4.5 | 0.26 | 0.33 | 0.40 | |
| | | | 6.0 | 0.26 | 0.33 | 0.40 | |
| I _{in} | Maximum Input Leakage Current | V _{in} = V _{CC} or GND | 6.0 | ±0.1 | ±1.0 | ±1.0 | μA |
| I _{CC} | Maximum Quiescent Supply Current (per Package) | V _{in} = V _{CC} or GND I _{out} = 0μA | 6.0 | 1.0 | 10 | 40 | μA |

AC CHARACTERISTICS (C_L = 50 pF, Input t_r = t_f = 6 ns)

| Symbol | Parameter | V _{CC} V | Guaranteed Limit | | | Unit |
|--|--|--|------------------|-------|--------|------|
| | | | -55 to 25°C | ≤85°C | ≤125°C | |
| t _{PLH} , t _{PHL} | Maximum Propagation Delay, Input A or B to Output Y (Figures 1 and 2) | 2.0 | 75 | 95 | 110 | ns |
| | | 3.0 | 30 | 40 | 55 | |
| | | 4.5 | 15 | 19 | 22 | |
| | | 6.0 | 13 | 16 | 19 | |
| t _{TLH} , t _{THL} | Maximum Output Transition Time, Any Output (Figures 1 and 2) | 2.0 | 75 | 95 | 110 | ns |
| | | 3.0 | 27 | 32 | 36 | |
| | | 4.5 | 15 | 19 | 22 | |
| | | 6.0 | 13 | 16 | 19 | |
| C _{in} | Maximum Input Capacitance | | 10 | 10 | 10 | pF |
| C _{PD} | Power Dissipation Capacitance (Per Buffer)* | Typical @ 25°C, V _{CC} = 5.0 V, V _{EE} = 0 V | | | pF | |
| | | 22 | | | | |

* Used to determine the no-load dynamic power consumption: P_D = C_{PD} V_{CC}²f + I_{CC} V_{CC}.

MC74HC00A

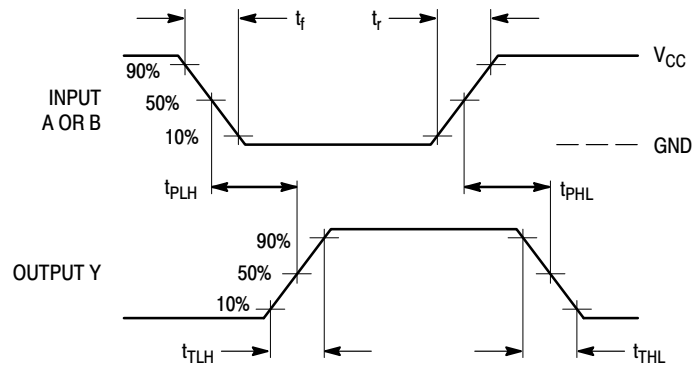
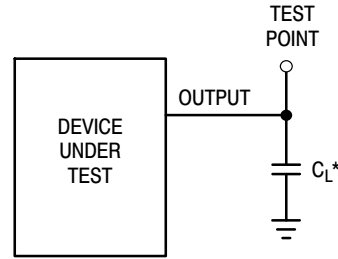

Figure 1. Switching Waveforms



*Includes all probe and jig capacitance

Figure 2. Test Circuit

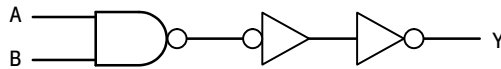
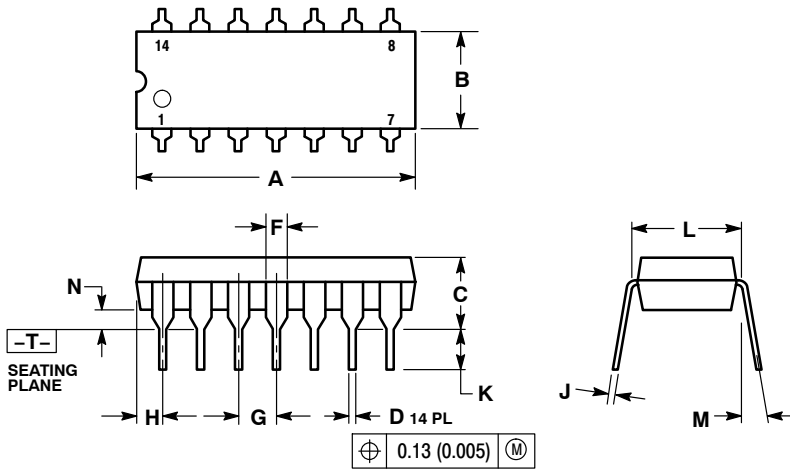

Figure 3. Expanded Logic Diagram
(1/4 of the Device)

MC74HC00A

PACKAGE DIMENSIONS

PDIP-14
N SUFFIX
CASE 646-06
ISSUE P



NOTES:

1. DIMENSIONING AND TOLERANCING PER ANSI Y14.5M, 1982.
2. CONTROLLING DIMENSION: INCH.
3. DIMENSION L TO CENTER OF LEADS WHEN FORMED PARALLEL.
4. DIMENSION B DOES NOT INCLUDE MOLD FLASH.
5. ROUNDED CORNERS OPTIONAL.

| DIM | INCHES | | MILLIMETERS | |
|-----|-----------|-------|-------------|-------|
| | MIN | MAX | MIN | MAX |
| A | 0.715 | 0.770 | 18.16 | 19.56 |
| B | 0.240 | 0.260 | 6.10 | 6.60 |
| C | 0.145 | 0.185 | 3.69 | 4.69 |
| D | 0.015 | 0.021 | 0.38 | 0.53 |
| F | 0.040 | 0.070 | 1.02 | 1.78 |
| G | 0.100 BSC | | 2.54 BSC | |
| H | 0.052 | 0.095 | 1.32 | 2.41 |
| J | 0.008 | 0.015 | 0.20 | 0.38 |
| K | 0.115 | 0.135 | 2.92 | 3.43 |
| L | 0.290 | 0.310 | 7.37 | 7.87 |
| M | --- | 10 ° | --- | 10 ° |
| N | 0.015 | 0.039 | 0.38 | 1.01 |

MC74HC00A

PACKAGE DIMENSIONS

SOIC-14 NB
CASE 751A-03
ISSUE K

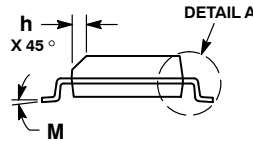
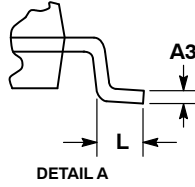
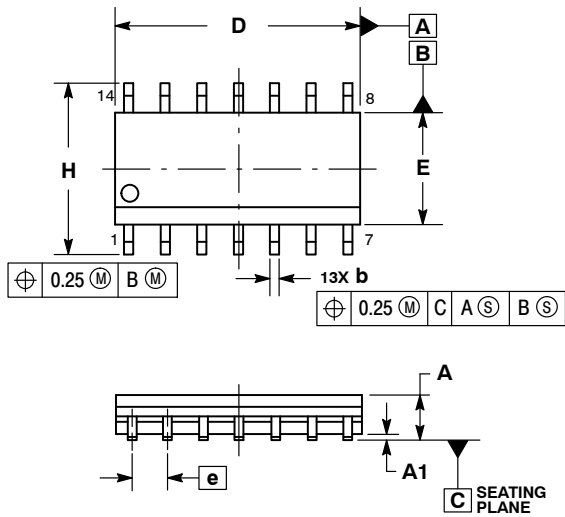

NOTES:

1. DIMENSIONING AND TOLERANCING PER ASME Y14.5M, 1994.
2. CONTROLLING DIMENSION: MILLIMETERS.
3. DIMENSION b DOES NOT INCLUDE DAMBAR PROTRUSION. ALLOWABLE PROTRUSION SHALL BE 0.13 TOTAL IN EXCESS OF AT MAXIMUM MATERIAL CONDITION.
4. DIMENSIONS D AND E DO NOT INCLUDE MOLD PROTRUSIONS.
5. MAXIMUM MOLD PROTRUSION 0.15 PER SIDE.

| DIM | MILLIMETERS | | INCHES | |
|-----|-------------|------|-----------|-------|
| | MIN | MAX | MIN | MAX |
| A | 1.35 | 1.75 | 0.054 | 0.068 |
| A1 | 0.10 | 0.25 | 0.004 | 0.010 |
| A3 | 0.19 | 0.25 | 0.008 | 0.010 |
| b | 0.35 | 0.49 | 0.014 | 0.019 |
| D | 8.55 | 8.75 | 0.337 | 0.344 |
| E | 3.80 | 4.00 | 0.150 | 0.157 |
| e | 1.27 BSC | | 0.050 BSC | |
| H | 5.80 | 6.20 | 0.228 | 0.244 |
| h | 0.25 | 0.50 | 0.010 | 0.019 |
| L | 0.40 | 1.25 | 0.016 | 0.049 |
| M | 0° | 7° | 0° | 7° |

SOLDERING FOOTPRINT*

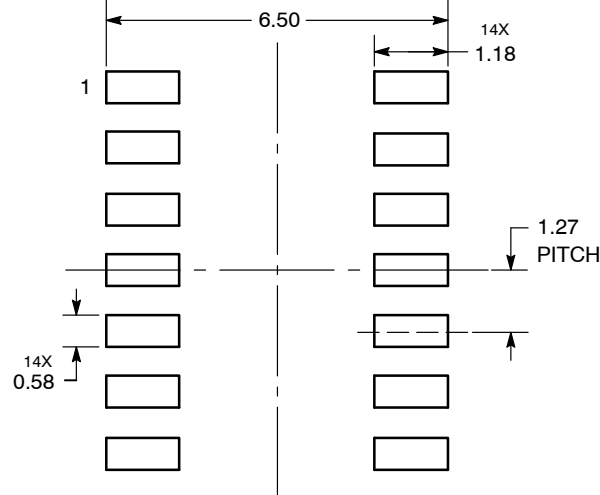

DIMENSIONS: MILLIMETERS

*For additional information on our Pb-Free strategy and soldering details, please download the ON Semiconductor Soldering and Mounting Techniques Reference Manual, SOLDERRM/D.

MC74HC00A

PACKAGE DIMENSIONS

TSSOP-14
DT SUFFIX
CASE 948G-01
ISSUE B

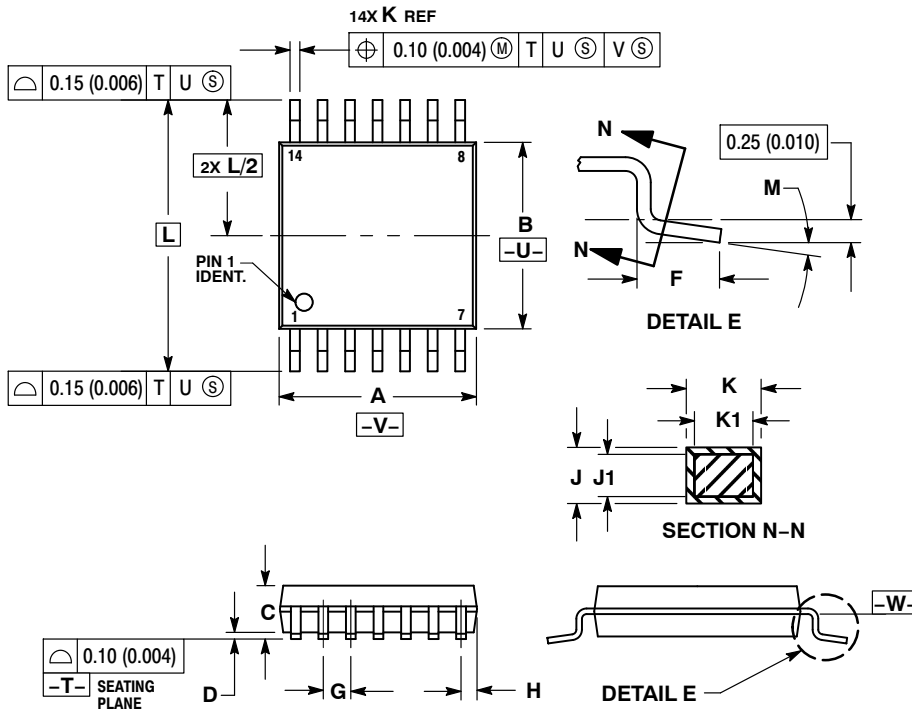

- NOTES:
1. DIMENSIONING AND TOLERANCING PER ANSI Y14.5M, 1982.
 2. CONTROLLING DIMENSION: MILLIMETER.
 3. DIMENSION A DOES NOT INCLUDE MOLD FLASH, PROTRUSIONS OR GATE BURRS. MOLD FLASH OR GATE BURRS SHALL NOT EXCEED 0.15 (0.006) PER SIDE.
 4. DIMENSION B DOES NOT INCLUDE INTERLEAD FLASH OR PROTRUSION. INTERLEAD FLASH OR PROTRUSION SHALL NOT EXCEED 0.25 (0.010) PER SIDE.
 5. DIMENSION K DOES NOT INCLUDE DAMBAR PROTRUSION. ALLOWABLE DAMBAR PROTRUSION SHALL BE 0.08 (0.003) TOTAL IN EXCESS OF THE K DIMENSION AT MAXIMUM MATERIAL CONDITION.
 6. TERMINAL NUMBERS ARE SHOWN FOR REFERENCE ONLY.
 7. DIMENSION A AND B ARE TO BE DETERMINED AT DATUM PLANE -U-.

| DIM | MILLIMETERS | | INCHES | |
|-----|-------------|------|-----------|-------|
| | MIN | MAX | MIN | MAX |
| A | 4.90 | 5.10 | 0.193 | 0.200 |
| B | 4.30 | 4.50 | 0.169 | 0.177 |
| C | --- | 1.20 | --- | 0.047 |
| D | 0.05 | 0.15 | 0.002 | 0.006 |
| F | 0.50 | 0.75 | 0.020 | 0.030 |
| G | 0.65 BSC | | 0.026 BSC | |
| H | 0.50 | 0.60 | 0.020 | 0.024 |
| J | 0.09 | 0.20 | 0.004 | 0.008 |
| J1 | 0.09 | 0.16 | 0.004 | 0.006 |
| K | 0.19 | 0.30 | 0.007 | 0.012 |
| K1 | 0.19 | 0.25 | 0.007 | 0.010 |
| L | 6.40 BSC | | 0.252 BSC | |
| M | 0° | 8° | 0° | 8° |

SOLDERING FOOTPRINT*

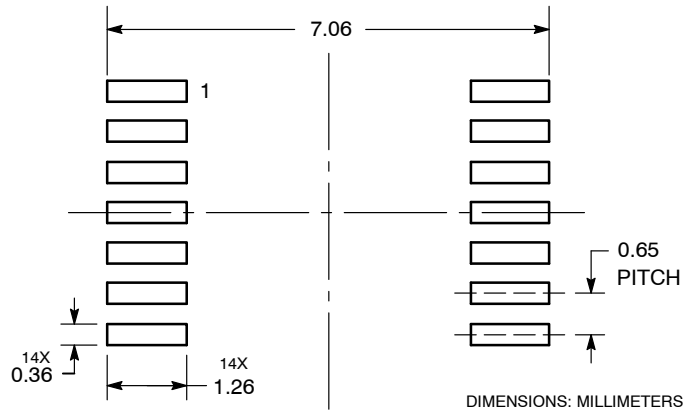

*For additional information on our Pb-Free strategy and soldering details, please download the ON Semiconductor Soldering and Mounting Techniques Reference Manual, SOLDERRM/D.

MC74HC00A

ON Semiconductor and  are registered trademarks of Semiconductor Components Industries, LLC (SCILLC). SCILLC reserves the right to make changes without further notice to any products herein. SCILLC makes no warranty, representation or guarantee regarding the suitability of its products for any particular purpose, nor does SCILLC assume any liability arising out of the application or use of any product or circuit, and specifically disclaims any and all liability, including without limitation special, consequential or incidental damages. "Typical" parameters which may be provided in SCILLC data sheets and/or specifications can and do vary in different applications and actual performance may vary over time. All operating parameters, including "Typicals" must be validated for each customer application by customer's technical experts. SCILLC does not convey any license under its patent rights nor the rights of others. SCILLC products are not designed, intended, or authorized for use as components in systems intended for surgical implant into the body, or other applications intended to support or sustain life, or for any other application in which the failure of the SCILLC product could create a situation where personal injury or death may occur. Should Buyer purchase or use SCILLC products for any such unintended or unauthorized application, Buyer shall indemnify and hold SCILLC and its officers, employees, subsidiaries, affiliates, and distributors harmless against all claims, costs, damages, and expenses, and reasonable attorney fees arising out of, directly or indirectly, any claim of personal injury or death associated with such unintended or unauthorized use, even if such claim alleges that SCILLC was negligent regarding the design or manufacture of the part. SCILLC is an Equal Opportunity/Affirmative Action Employer. This literature is subject to all applicable copyright laws and is not for resale in any manner.

PUBLICATION ORDERING INFORMATION

LITERATURE FULFILLMENT:

Literature Distribution Center for ON Semiconductor
P.O. Box 5163, Denver, Colorado 80217 USA
Phone: 303-675-2175 or 800-344-3860 Toll Free USA/Canada
Fax: 303-675-2176 or 800-344-3867 Toll Free USA/Canada
Email: orderlit@onsemi.com

N. American Technical Support: 800-282-9855 Toll Free
USA/Canada
Europe, Middle East and Africa Technical Support:
Phone: 421 33 790 2910
Japan Customer Focus Center
Phone: 81-3-5817-1050

ON Semiconductor Website: www.onsemi.com
Order Literature: <http://www.onsemi.com/orderlit>
For additional information, please contact your local
Sales Representative

Компания «Life Electronics» занимается поставками электронных компонентов импортного и отечественного производства от производителей и со складов крупных дистрибьюторов Европы, Америки и Азии.

С конца 2013 года компания активно расширяет линейку поставок компонентов по направлению коаксиальный кабель, кварцевые генераторы и конденсаторы (керамические, пленочные, электролитические), за счёт заключения дистрибьюторских договоров

Мы предлагаем:

- Конкурентоспособные цены и скидки постоянным клиентам.
- Специальные условия для постоянных клиентов.
- Подбор аналогов.
- Поставку компонентов в любых объемах, удовлетворяющих вашим потребностям.
- Приемлемые сроки поставки, возможна ускоренная поставка.
- Доставку товара в любую точку России и стран СНГ.
- Комплексную поставку.
- Работу по проектам и поставку образцов.
- Формирование склада под заказчика.
- Сертификаты соответствия на поставляемую продукцию (по желанию клиента).
- Тестирование поставляемой продукции.
- Поставку компонентов, требующих военную и космическую приемку.
- Входной контроль качества.
- Наличие сертификата ISO.

В составе нашей компании организован Конструкторский отдел, призванный помогать разработчикам, и инженерам.

Конструкторский отдел помогает осуществить:

- Регистрацию проекта у производителя компонентов.
- Техническую поддержку проекта.
- Защиту от снятия компонента с производства.
- Оценку стоимости проекта по компонентам.
- Изготовление тестовой платы монтаж и пусконаладочные работы.



Тел: +7 (812) 336 43 04 (многоканальный)

Email: org@lifeelectronics.ru