

# HDSP-076x Series

## Hexadecimal and Numeric Displays for Industrial Applications

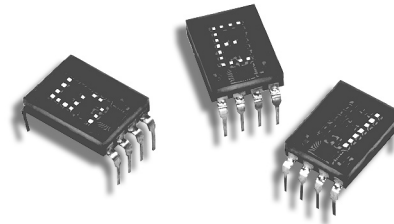

## Data Sheet



**HDSP-076x Series, HDSP-077x Series  
HDSP-086x Series, HDSP-096x Series**

### Description

These solid state display devices are designed and tested for use in adverse industrial environments. The character height is 7.4 mm (0.29 inch). The numeric and hexadecimal devices incorporate an on-board IC that contains the data memory, decoder and display driver functions.

The numeric devices decode positive BCD logic into characters "0-9", a "-" sign, decimal point, and a test pattern. The hexadecimal devices decode positive BCD logic into 16 characters, "0-9, A-F." An input is provided on the hexadecimal devices to blank the display (all LEDs off) without losing the contents of the memory.

The over range device displays "±1" and right hand decimal point and is typically driven via external switching transistors.

### Features

- Three colors: High-efficiency red  
Yellow  
High performance green
- Two high-efficiency red options
  - Low power
  - High brightness
- Three character options
  - Numeric
  - Hexadecimal
  - Over range
- Performance guaranteed over temperature
- Memory latch/decoder/driver: TTL compatible
- 4 x 7 dot matrix character
- Categorized for luminous intensity
- Yellow and green categorized for color

### Device Selection Guide

Part Number	Color	Description	Front View
0760	High-Efficiency	Numeric, Right Hand DP	A
0761	Red	Numeric, Left Hand DP	B
0762	Low Power	Hexadecimal	C
0763		Over Range ±1	D
0770	High-Efficiency	Numeric, Right Hand DP	A
0771	Red	Numeric, Left Hand DP	B
0772	High Brightness	Hexadecimal	C
0860	Yellow	Numeric, Right Hand DP	A
0861		Numeric, Left Hand DP	B
0862		Hexadecimal	C
0863		Over Range ±1	D
0960	Green	Numeric, Right Hand DP	A
0961		Numeric, Left Hand DP	B
0962		Hexadecimal	C
0963		Over Range ±1	D

### Typical Applications

- Industrial equipment
- Computer peripherals
- Instrumentation
- Telecommunication equipment

# Package Dimensions

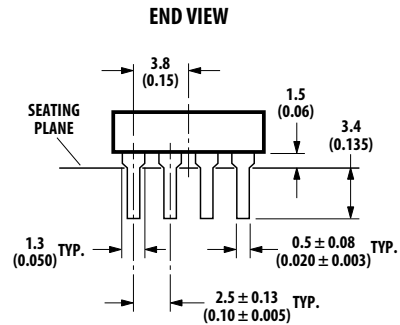
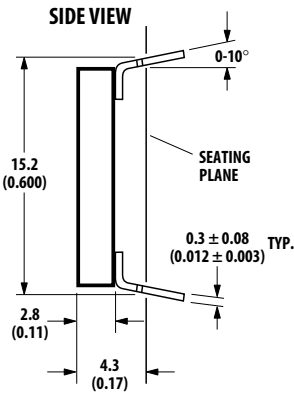
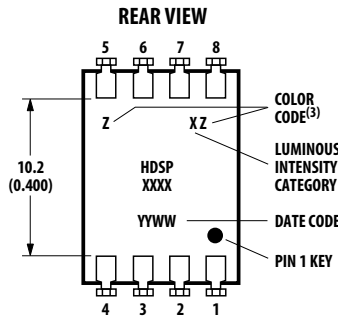
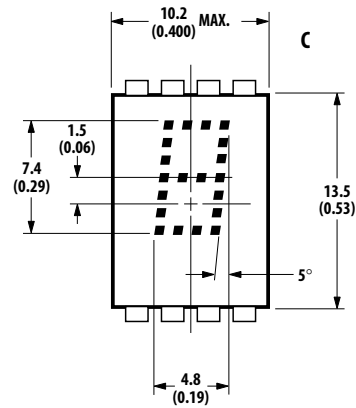
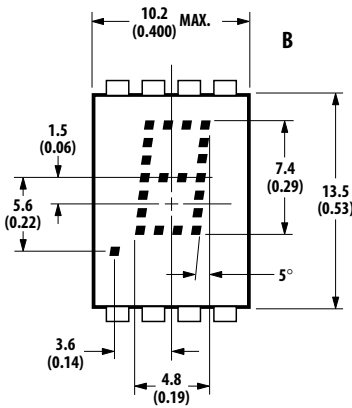
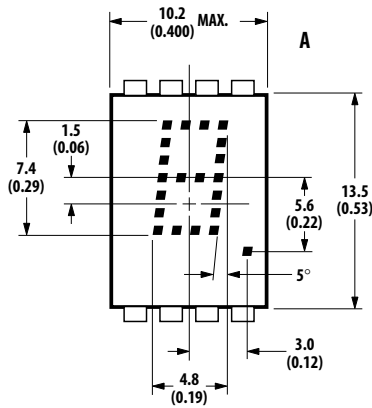

PIN	FUNCTION	
	NUMERIC	HEXADECIMAL
1	Input 2	Input 2
2	Input 4	Input 4
3	Input 8	Input 8
4	Decimal Point	Blanking Control
5	Latch Enable	Latch Enable
6	Ground	Ground
7	Vcc	Vcc
8	Input 1	Input 1

**NOTES:**

1. DIMENSIONS IN MILLIMETERS AND (INCHES).
2. DIGIT CENTER LINE IS  $\pm 0.38$  mm ( $\pm 0.015$  INCH) FROM PACKAGE CENTER LINE.
3. UNLESS OTHERWISE SPECIFIED, THE TOLERANCE ON ALL DIMENSIONS IS  $\pm 0.38$  mm ( $\pm 0.015$  INCH).
4. HDSP-0860 AND HDSP-0960 SERIES.

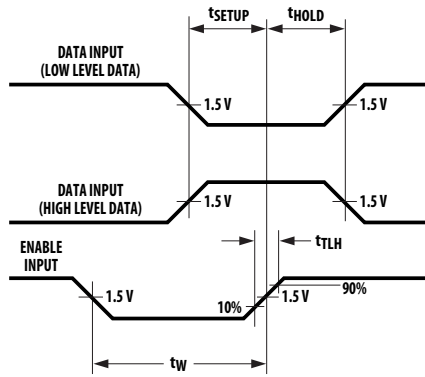

Figure 1. Timing diagram.



Figure 2. Logic block diagram.

TRUTH TABLE					
BCD DATA <sup>[1]</sup>				NUMERIC	HEXADECIMAL
X <sub>8</sub>	X <sub>4</sub>	X <sub>2</sub>	X <sub>1</sub>		
L	L	L	L	0	0
L	L	L	H	1	1
L	L	H	L	2	2
L	L	H	H	3	3
L	H	L	L	4	4
L	H	L	H	5	5
L	H	H	L	6	6
L	H	H	H	7	7
H	L	L	L	8	8
H	L	L	H	9	9
H	L	H	L	A	A
H	L	H	H	(BLANK)	B
H	H	L	L	(BLANK)	C
H	H	L	H	...	D
H	H	H	L	(BLANK)	E
H	H	H	H	(BLANK)	F
DECIMAL PT. <sup>[2]</sup>				ON	V <sub>DP</sub> = L
				OFF	V <sub>DP</sub> = H
ENABLE <sup>[1]</sup>				LOAD DATA	V <sub>E</sub> = L
				LATCH DATA	V <sub>E</sub> = H
BLANKING <sup>[3]</sup>				DISPLAY-ON	V <sub>B</sub> = L
				DISPLAY-OFF	V <sub>B</sub> = H

NOTES:

1. H = LOGIC HIGH; L = LOGIC LOW. WITH THE ENABLE INPUT AT LOGIC HIGH, CHANGES IN BCD INPUT LOGIC LEVELS HAVE NO EFFECT UPON DISPLAY MEMORY, DISPLAYED CHARACTER, OR DP.
2. THE DECIMAL POINT INPUT, DP, PERTAINS ONLY TO THE NUMERIC DISPLAYS.
3. THE BLANKING CONTROL INPUT, B, PERTAINS ONLY TO THE HEXADECIMAL DISPLAYS. BLANKING INPUT HAS NO EFFECT UPON DISPLAY MEMORY.

## Absolute Maximum Ratings

Description	Symbol	Min.	Max.	Unit
Storage Temperature, Ambient	$T_S$	-65	+100	°C
Operating Temperature, Ambient <sup>[1]</sup>	$T_A$	-55	+85	°C
Supply Voltage <sup>[2]</sup>	$V_{CC}$	-0.5	+7.0	V
Voltage Applied to Input Logic, dp and Enable Pins	$V_I, V_{DP}, V_E$	-0.5	$V_{CC}$	V
Voltage Applied to Blanking Input <sup>[2]</sup>	$V_B$	-0.5	$V_{CC}$	V
Soldering Temperature [1.59 mm (0.063 inch) Below Body]				
Solder Dipping, max. 5 Seconds			260	°C
Wave Soldering, max. 3 Seconds			250	°C

## Recommended Operating Conditions

Description	Symbol	Min.	Nom.	Max.	Unit
Supply Voltage <sup>[2]</sup>	$V_{CC}$	4.5	5.0	5.5	V
Operating Temperature, Ambient <sup>[1]</sup>	$T_A$	-55		+85	°C
Enable Pulse Width	$t_W$	100			nsec
Time Data Must Be Held Before Positive Transition of Enable Line	$t_{SETUP}$	50			nsec
Time Data Must Be Held After Positive Transition of Enable Line	$t_{HOLD}$	50			nsec
Enable Pulse Rise Time	$t_{TLH}$			1.0	msec

## Optical Characteristics at $T_A = 25^\circ\text{C}$ , $V_{CC} = 5.0\text{ V}$

Device	Description	Symbol	Min.	Typ.	Max.	Unit
HDSP-0760 Series	Luminous Intensity per LED (Digit Average) <sup>[3,4]</sup>	$I_V$	65	140		$\mu\text{cd}$
	Peak Wavelength	$\lambda_{PEAK}$		635		nm
	Dominant Wavelength <sup>[5]</sup>	$\lambda_d$		626		nm
HDSP-0770 Series	Luminous Intensity per LED (Digit Average) <sup>[3,4]</sup>	$I_V$	260	620		$\mu\text{cd}$
	Peak Wavelength	$\lambda_{PEAK}$		635		nm
	Dominant Wavelength <sup>[5]</sup>	$\lambda_d$		626		nm
HDSP-0860 Series	Luminous Intensity per LED (Digit Average) <sup>[3,4]</sup>	$I_V$	215	490		$\mu\text{cd}$
	Peak Wavelength	$\lambda_{PEAK}$		583		nm
	Dominant Wavelength <sup>[5,6]</sup>	$\lambda_d$		585		nm
HDSP-0960 Series	Luminous Intensity per LED (Digit Average) <sup>[3,4]</sup>	$I_V$	298	1100		$\mu\text{cd}$
	Peak Wavelength	$\lambda_{PEAK}$		568		nm
	Dominant Wavelength <sup>[5,6]</sup>	$\lambda_d$		574		nm

### Notes:

- The nominal thermal resistance of a display mounted in a socket that is soldered onto a printed circuit board is  $R_{\theta JA} = 50^\circ\text{C/W/device}$ . The device package thermal resistance is  $R_{\theta J-PIN} = 15^\circ\text{C/W/device}$ . The thermal resistance device pin-to-ambient through the PC board should not exceed  $35^\circ\text{C/W/device}$  for operation at  $T_A = +85^\circ\text{C}$ .
- Voltage values are with respect to device ground, pin 6.
- These displays are categorized for luminous intensity with the intensity category designated by a letter code located on the back of the display package. Case temperature of the device immediately prior to the light measurement is equal to  $25^\circ\text{C}$ .

**Electrical Characteristics;  $T_A = -55^\circ\text{C}$  to  $+85^\circ\text{C}$**

Description	Symbol	Test Conditions	Min.	Typ. <sup>[7]</sup>	Max.	Unit	
Supply Current HDSP-0760 Series	I <sub>CC</sub>	V <sub>CC</sub> = 5.5 V (Characters "5." or "B" Displayed)		78	105	mA	
HDSP-0770 Series HDSP-0860 Series HDSP-0960 Series				120	175		
Power Dissipation HDSP-0760 Series			P <sub>T</sub>		390	573	mW
HDSP-0770 Series HDSP-0860 Series HDSP-0960 Series					690	963	
Logic, Enable and Blanking Low-Level Input Voltage	V <sub>IL</sub>	V <sub>CC</sub> = 4.5 V			0.8	V	
Logic, Enable and Blanking High-Level Input Voltage	V <sub>IH</sub>		2.0			V	
Logic and Enable Low-Level Input Current	I <sub>IL</sub>	V <sub>CC</sub> = 5.5 V			-1.6	mA	
Blanking Low-Level Input Current	I <sub>BL</sub>	V <sub>IL</sub> = 0.4 V			-10	μA	
Logic, Enable and Blanking High-Level Input Current	I <sub>IH</sub>	V <sub>CC</sub> = 5.5 V V <sub>IH</sub> = 2.4 V			+40	μA	
Weight				1.0		gm	
Leak Rate					5x10 <sup>-8</sup>	cc/sec	

**Notes:**

4. The luminous intensity at a specific operating ambient temperature, I<sub>V</sub> (T<sub>A</sub>) may be approximated from the following exponential equation:

$$I_V(T_A) = I_V(25^\circ\text{C}) e^{[k(T_A - 25^\circ\text{C})]}$$

Device	K
HDSP-0760 Series HDSP-0770 Series	-0.0131/°C
HDSP-0860 Series	-0.0112/°C
HDSP-0960 Series	-0.0104/°C

- The dominant wavelength, λ<sub>d</sub>, is derived from the CIE Chromaticity Diagram and is that single wavelength which defines the color of the device.
- The HDSP-0860 and HDSP-0960 series devices are categorized as to dominant wavelength with the category designated by a number on the back of the display package.
- All typical values at V<sub>CC</sub> = 5.0 V and T<sub>A</sub> = 25°C.

## Operational Considerations

### Electrical

These devices use a modified 4x7 dot matrix light emitting diode to display decimal/hexadecimal numeric information. The high efficiency red and yellow LEDs are GaAsP epitaxial layer on a GaP transparent substrate. The green LEDs are GaP epitaxial layer on a GaP transparent substrate. The LEDs are driven by constant current drivers, BCD information is accepted by the display memory when the enable line is at logic low and the data is latched when the enable is at logic high. Using the enable pulse width and data setup and hold times listed in the Recommended Operating Conditions allows data to be clocked into an array of displays at a 6.7 MHz rate.

The decimal point input is active low true and this data is latched into the display memory in the same fashion as the BCD data. The decimal point LED is driven by the on-board IC.

The blanking control input on the hexadecimal displays blanks (turns off) the displayed information without disturbing the contents of display memory. The display is blanked at a minimum threshold level of 2.0 volts. When blanked, the display standby power is nominally 250 mW at  $T_A = 25^\circ\text{C}$ .

### Mechanical

The primary thermal path for power dissipation is through the device leads. Therefore, to insure reliable operation up to an ambient temperature of  $+85^\circ\text{C}$ , it is important to maintain a case-to-ambient thermal resistance of less than  $35^\circ\text{C watt/device}$  as measured on top of display pin 3.

For information on soldering and post solder cleaning see Application Note 1027, *Soldering LED Components*.

### Contrast Enhancement

These display devices are designed to provide an optimum ON/OFF contrast when placed behind an appropriate contrast enhancement filter. For further information, please refer to Application Note 1015, *Contrast Enhancement Techniques for LED Displays*.

### Over Range Display

The over range devices display “±1” and decimal point. The character height and package configuration are the same as the numeric and hexadecimal devices. Character selection is obtained via external switching transistors and current limiting resistors.

## Package Dimensions



PIN	FUNCTION
1	Plus
2	Numeral One
3	Numeral One
4	DP
5	Open
6	Open
7	V <sub>CC</sub>
8	Minus/Plus

Character	Pin			
	1	2,3	4	8
+	1	X	X	1
-	0	X	X	1
1	X	1	X	X
Decimal Point	X	X	1	X
Blank	0	0	0	0

#### Notes:

- 0: Line switching transistor in Figure 7 cutoff.
- 1: Line switching transistor in Figure 7 saturated.
- X: 'don't care'

NOTE: DIMENSIONS IN MILLIMETERS AND (INCHES).

### Absolute Maximum Ratings

Description	Symbol	Min.	Max.	Unit
Storage Temperature, Ambient	$T_S$	-65	+100	°C
Operating Temperature, Ambient	$T_A$	-55	+85	°C
Forward Current, Each LED	$I_F$		10	mA
Reverse Voltage, Each LED	$V_R$		5	V

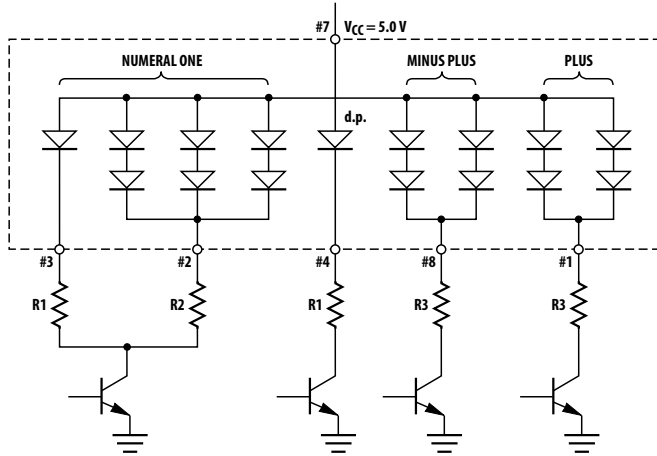

Figure 3. Typical driving circuit.

### Recommended Operating Conditions $V_{CC} = 5.0\text{ V}$

	Forward Current Per Device LED, mA	Resistor Value		
		$R_1$	$R_2$	$R_3$
HDSP-0763				
Low Power	2.8	1300	200	300
High Brightness	8	360	47	68
HDSP-0863	8	360	36	56
HDSP-0963	8	360	30	43

### Luminous Intensity per LED

(Digit Average)<sup>[3,4]</sup> at  $T_A = 25^\circ\text{C}$

Device	Test Conditions	Min.	Typ.	Units
HDSP-0763	$I_F = 2.8\text{ mA}$	65	140	$\mu\text{cd}$
	$I_F = 8\text{ mA}$		620	$\mu\text{cd}$
HDSP-0863	$I_F = 8\text{ mA}$	215	490	$\mu\text{cd}$
HDSP-0963	$I_F = 8\text{ mA}$	298	1100	$\mu\text{cd}$

**Electrical Characteristics: T<sub>A</sub> = -55°C to +85°C**

Device	Description	Symbol	Test Conditions	Min.	Typ.	Max.	Unit
HDSP-0763	Power Dissipation (All LEDs Illuminated)	P <sub>T</sub>	I <sub>F</sub> = 2.8 mA		72		mW
			I <sub>F</sub> = 8 mA		224	282	
	Forward Voltage per LED	V <sub>F</sub>	I <sub>F</sub> = 2.8 mA		1.6		V
			I <sub>F</sub> = 8 mA		1.75	2.2	
HDSP-0863	Power Dissipation (All LEDs Illuminated)	P <sub>T</sub>	I <sub>F</sub> = 8 mA		237	282	mW
	Forward Voltage per LED	V <sub>F</sub>			1.90	2.2	V
HDSP-0963	Power Dissipation (All LEDs Illuminated)	P <sub>T</sub>	I <sub>F</sub> = 8 mA		243	282	mW
	Forward Voltage per LED	V <sub>F</sub>			1.85	2.2	V

**Intensity Bin Limits for HDSP-0760 Series**

Bin	Intensity Range (μcd)	
	Min.	Max.
A	65.00	102.14
B	84.29	137.86
C	114.29	200.00
D	165.71	300.00
E	260.00	487.86
F	402.86	755.71
G	625.00	1171.43

**Note:**

Test conditions as specified in Optical Characteristic table.

**Intensity Bin Limits for HDSP-0860 Series**

Bin	Intensity Range (μcd)	
	Min.	Max.
A	215.00	337.86
B	279.29	456.43
C	377.14	662.14
D	547.14	992.86
E	820.71	1539.29
F	1272.14	2385.71

**Note:**

Test conditions as specified in Optical Characteristic table.

**Color Bin Limits**

Color	Bin	Color Range (nm)	
		Min.	Max.
Yellow	1	581.5	585.0
	2	584.0	587.5
	3	586.5	590.0
Green	1	570.0	574.0
	2	573.0	577.0
	3	576.0	580.0

**Note:**

Test conditions as specified in Optical Characteristic table.

**Intensity Bin Limits for HDSP-0770 Series**

Bin	Intensity Range (μcd)	
	Min.	Max.
E	260.00	487.64
F	403.00	755.79
G	624.64	1171.50
H	969.00	1817.00

**Note:**

Test conditions as specified in Optical Characteristic table.

**Intensity Bin Limits for HDSP-0960 Series**

Bin	Intensity Range (μcd)	
	Min.	Max.
C	298.57	523.57
D	432.86	785.00
E	648.57	1175.00
F	971.43	1757.86
G	1452.86	2629.29

**Note:**

Test conditions as specified in Optical Characteristic table.

For product information and a complete list of distributors, please go to our website: [www.avagotech.com](http://www.avagotech.com)



Компания «Life Electronics» занимается поставками электронных компонентов импортного и отечественного производства от производителей и со складов крупных дистрибьюторов Европы, Америки и Азии.

С конца 2013 года компания активно расширяет линейку поставок компонентов по направлению коаксиальный кабель, кварцевые генераторы и конденсаторы (керамические, пленочные, электролитические), за счёт заключения дистрибьюторских договоров

Мы предлагаем:

- Конкуренспособные цены и скидки постоянным клиентам.
- Специальные условия для постоянных клиентов.
- Подбор аналогов.
- Поставку компонентов в любых объемах, удовлетворяющих вашим потребностям.
- Приемлемые сроки поставки, возможна ускоренная поставка.
- Доставку товара в любую точку России и стран СНГ.
- Комплексную поставку.
- Работу по проектам и поставку образцов.
- Формирование склада под заказчика.
- Сертификаты соответствия на поставляемую продукцию (по желанию клиента).
- Тестирование поставляемой продукции.
- Поставку компонентов, требующих военную и космическую приемку.
- Входной контроль качества.
- Наличие сертификата ISO.

В составе нашей компании организован Конструкторский отдел, призванный помогать разработчикам, и инженерам.

Конструкторский отдел помогает осуществить:

- Регистрацию проекта у производителя компонентов.
- Техническую поддержку проекта.
- Защиту от снятия компонента с производства.
- Оценку стоимости проекта по компонентам.
- Изготовление тестовой платы монтаж и пусконаладочные работы.



Тел: +7 (812) 336 43 04 (многоканальный)  
Email: [org@lifeelectronics.ru](mailto:org@lifeelectronics.ru)