

Force-Guided Relays G7SA



Rev. 9.09

Compact, Slim Relays Conforming to EN Standards

- Relays with forcibly guided contacts (EN50205 Class A, certified by VDE)
- Supports the CE marking of machinery (Machinery Directive)
- Helps avoid hazardous machine status when used as part of an interlocking circuit
- Four-pole and six-pole Relays are available
- The relay's terminal arrangement simplifies PWB pattern design
- Reinforced insulation between inputs and outputs. Reinforced insulation between some poles of different polarity.



Specifications

Ratings

Coil

Rated Voltage	Rated Current (mA)	Coil Resistance (Ω)	Must Operate Voltage (V)	Must Release Voltage (V)	Max. Voltage (V)	Power Consumption (mW)
24 VDC	4 poles: 15 6 poles: 20.8	4 poles: 1,600 6 poles: 1,152	75% max.	10% min.	110%	4 poles: Approx. 360 6 poles: Approx. 500

Notes:

1. The rated current and coil resistance are measured at a coil temperature of 23°C with tolerances of ±15%.
2. Performance characteristics are based on a coil temperature of 23°C.
3. The maximum voltage is based on an ambient operating temperature of 23°C maximum.

Contacts

	Resistive Load
Rated load	6 A at 250 VAC, 6 A at 30 VDC
Rated carry current	6 A
Max. switching voltage	250 VAC, 125 VDC
Max. switching current	6 A

Certified Standards

- EN Standards, VDE Certified
EN61810-1 (Electromechanical non-specified time all-or-nothing relays)
EN50205 (Relays with forcibly guided (linked) contacts)
- UL standard UL508 Industrial Control Devices
- CSA standard CSA C22.2 No. 14 Industrial Control Devices

Forcibly-Guided Contacts (from EN50205)

If an NO contact becomes welded, all NC contacts will maintain a minimum distance of 0.5 mm when the coil is not energized. Likewise if an NC contact becomes welded, all NO contacts will maintain a minimum distance of 0.5 mm when the coil is energized.

Characteristics of Sockets

Model	Continuous Current	Dielectric Strength	Insulation Resistance
P7SA-1□	6 A *1	2,500 VAC for 1 min. between poles	1,000 MΩ min. *2

Notes:

Use the P7SA-1□F-ND in the ambient temperature range of -20 to 70°C.

Use the P7SA-1□F and P7SA-1□F-ND in the ambient humidity range of 45 to 85%.

*1. When operating the P7SA-1□F at a temperature between 55 and 85°C, reduce the continuous current (6 A at 55°C or less) by 0.1 A for each degree above 55°C.

When operating the P7SA-1□F-ND at a temperature between 50 and 70°C, reduce the continuous current (6 A at 50°C or less) by 0.3 A for each degree above 50°C.

*2. Measurement conditions: Measurement of the same points as for the dielectric strength at 500 VDC.

Engineering Data

Durability Curve

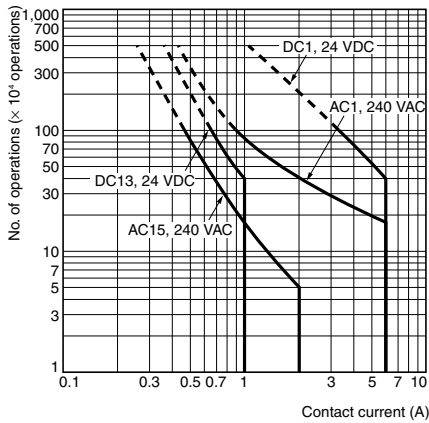

Dimensions

(mm)

G7SA-3A1B G7SA-2A2B

H

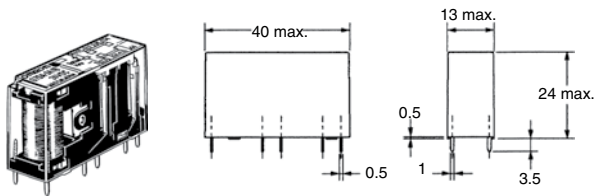

Terminal Arrangement/ Internal Connection Diagram (Bottom View)

G7SA-3A1B

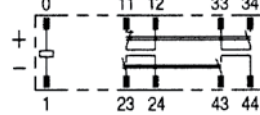

Printed Circuit Board Design Diagram (Bottom View)

(±0.1 tolerance)

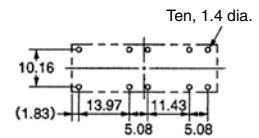

Notes:

- Terminals 23-24, 33-34, and 43-44 are normally open. Terminals 11-12 and 21-22 are normally closed.
- The colors of the cards inside the Relays are as follows: G7SA-3A1B: Blue and G7SA-2A2B: White.

G7SA-5A1B G7SA-4A2B G7SA-3A3B

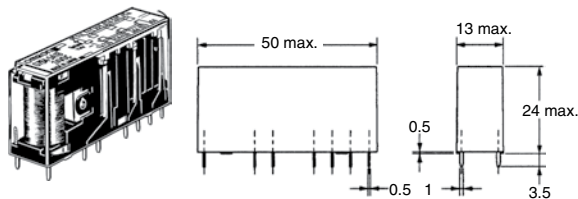

Terminal Arrangement/ Internal Connection Diagram (Bottom View)

G7SA-5A1B

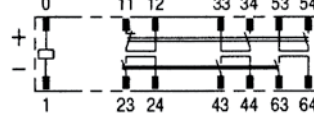

Printed Circuit Board Design Diagram (Bottom View)

(±0.1 tolerance)

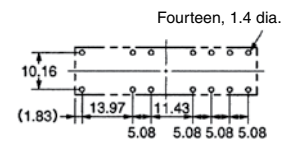

Notes:

- Terminals 23-24, 33-34, 43-44, 53-54, and 63-64 are normally open. Terminals 11-12, 21-22, and 31-32 are normally closed.
- The colors of the cards inside the Relays are as follows: G7SA-5A1B: Blue, G7SA-4A2B: White, and G7SA-3A3B: Yellow.

G7SA-4A2B

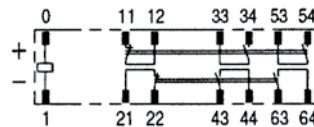

G7SA-3A3B



Dimensions (continued)

(mm)

Track-mounting Socket
P7SA-10F, P7SA-10F-ND

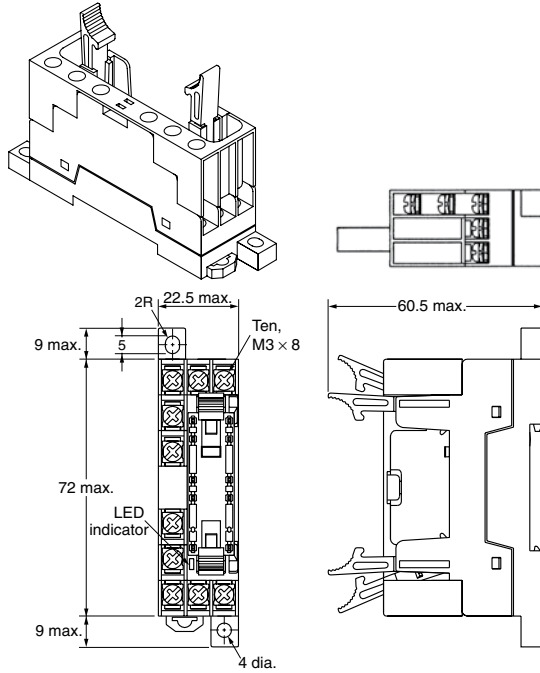

Note 1: The socket is shown with the finger cover removed.
Note 2: Only the -ND Sockets have LED indicators (orange)

Terminal Arrangement/Internal Connection Diagram
(Top View)

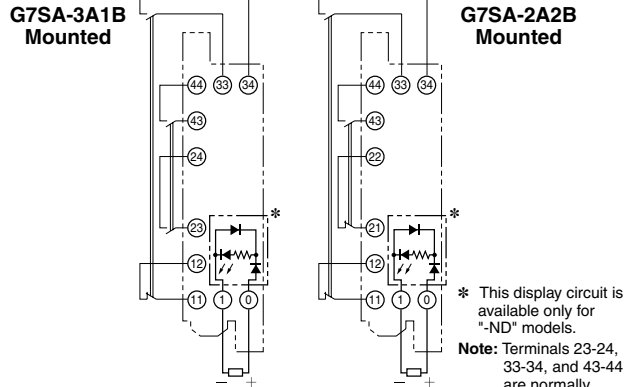

* This display circuit is available only for "-ND" models.
Note: Terminals 23-24, 33-34, and 43-44 are normally open. Terminals 11-12 and 21-22 are normally closed.

Mounting Hole Placement Diagram
(Top View)

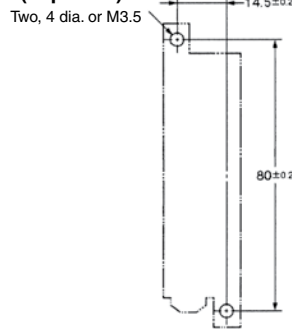

H

Track-mounting Socket
P7SA-14F, P7SA-14F-ND

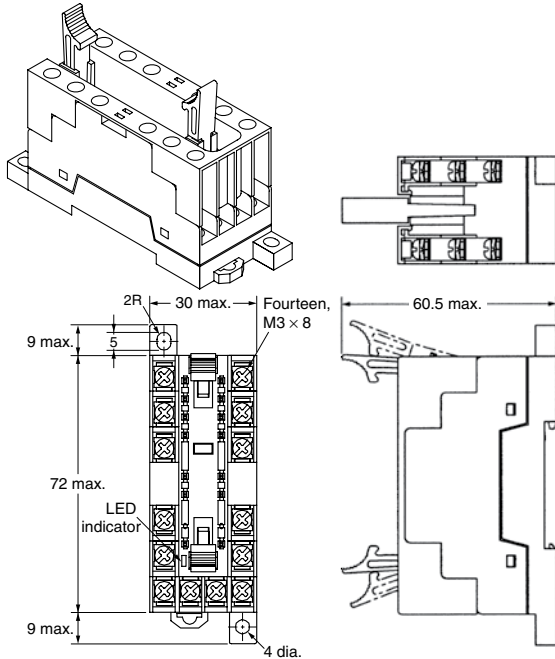

Note 1: The socket is shown with the finger cover removed.
Note 2: Only the -ND Sockets have LED indicators (orange).

Terminal Arrangement/Internal Connection Diagram
(Top View)

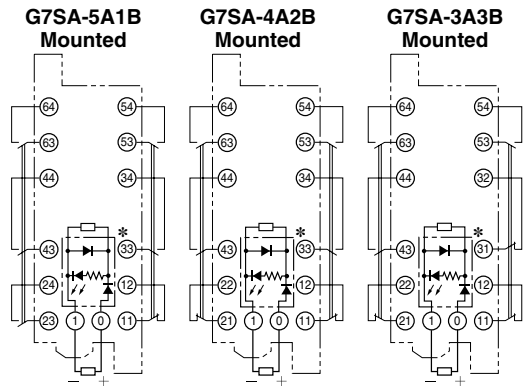

Mounting Hole Placement Diagram
(Top View)

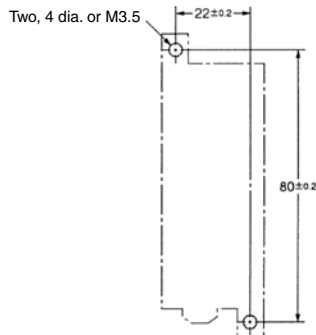

* This display circuit is available only for "-ND" models.
Note: Terminals 23-24, 33-34, 43-44, 53-54, and 63-64 are normally open. Terminals 11-12, 21-22, and 31-32 are normally closed.

Dimensions (continued)

Back-mounting Socket (for PCB) P7SA-10P

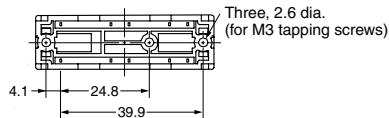
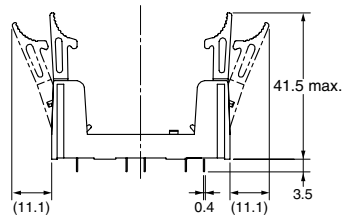
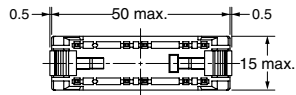
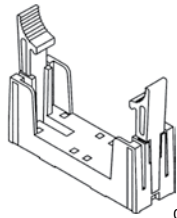

Terminal Arrangement/Internal Connection Diagram (Bottom View)

Mounting Hole Placement (Bottom View)
(±0.1 tolerance)

G7SA-3A1B Mounted

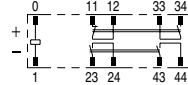

G7SA-2A2B Mounted

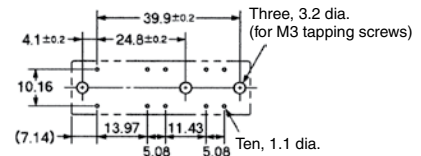
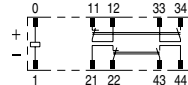

Note: Terminals 23-24, 33-34, and 43-44 are normally open. Terminals 11-12 and 21-22 are normally closed.

H

Back-mounting Socket (for PCB) P7SA-14P

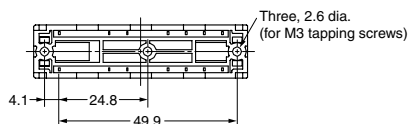
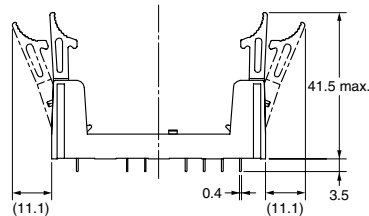
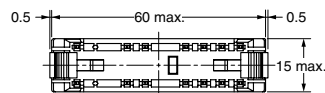
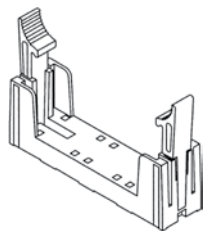

Terminal Arrangement/Internal Connection Diagram (Bottom View)

Mounting Hole Placement (Bottom View)
(±0.1 tolerance)

G7SA-5A1B Mounted



G7SA-4A2B Mounted

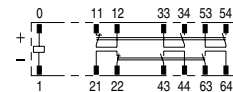

G7SA-3A3B Mounted

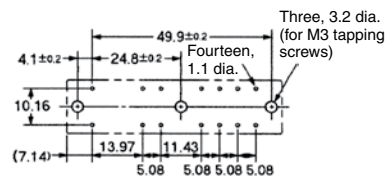
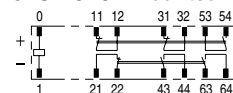

Note: Terminals 23-24, 33-34, 43-44, 53-54, and 63-64 are normally open. Terminals 11-12, 21-22, and 31-32 are normally closed.

Ordering

Model Number Legend

G7SA - □ A □ B

① ②

- ① NO Contact Poles
 2: DPST-NO
 3: 3PST-NO
 4: 4PST-NO
 5: 5PST-NO
- ② NC Contact Poles
 1: SPST-NC
 2: DPST-NC
 3: 3PST-NC

Relays with Forcibly Guided Contacts

Type	Sealing	Poles	Contact Configuration	Rated Voltage*	Model
Standard	Flux-tight	4 poles	3PST-NO, SPST-NC	24 VDC	G7SA-3A1B
			DPST-NO, DPST-NC		G7SA-2A2B
		6 poles	5PST-NO, SPST-NC		G7SA-5A1B
			4PST-NO, DPST-NC		G7SA-4A2B
			3PST-NO, 3PST-NC		G7SA-3A3B

*Consult your Omron STI representative for details on rated voltages of 12 VDC, 18 VDC, 21 VDC and 48 VDC.

H

Sockets

Type	LED Indicator	Poles	Rated Voltage	Model
Track-mounting	No	4 poles	---	P7SA-10F
		6 poles		P7SA-14F
	Yes	4 poles	24 VDC	P7SA-10F-ND
		6 poles		P7SA-14F-ND
Back-mounting	No	4 poles	---	P7SA-10P
		6 poles		P7SA-14P

Relays with Forcibly Guided Contacts and Track Mounting Sockets (assemblies)

Relay Specifications			Socket Specifications			
Poles	Contact Configuration	Rated Coil Voltage	Type	LED Indicator	LED Rated Voltage	Assembly Model
4 poles	DPST-NO, DPST-NC	24 VDC	Track Mounting and screw mounting possible	No		FGRMS22-24
4 poles	3PST-NO, SPST-NC	24 VDC	Track Mounting and screw mounting possible	No		FGRM-S31-24
6 poles	3PST-NO, 3PST-NC	24 VDC	Track Mounting and screw mounting possible	No		FGRM-S33-24
6 poles	4PST-NO, 2PST-NC	24 VDC	Track Mounting and screw mounting possible	No		FGRM-S42-24
6 poles	5PST-NO, SPST-NC	24 VDC	Track Mounting and screw mounting possible	No		FGRM-S51-24
4 poles	DPST-NO, DPST-NC	24 VDC	Track Mounting and screw mounting possible	Yes	24 VDC	FGRMS22-24-LED
4 poles	3PST-NO, SPST-NC	24 VDC	Track Mounting and screw mounting possible	Yes	24 VDC	FGRM-S31-24-LED
6 poles	3PST-NO, 3PST-NC	24 VDC	Track Mounting and screw mounting possible	Yes	24 VDC	FGRM-S33-24-LED
6 poles	4PST-NO, 2PST-NC	24 VDC	Track Mounting and screw mounting possible	Yes	24 VDC	FGRM-S42-24-LED
6 poles	5PST-NO, SPST-NC	24 VDC	Track Mounting and screw mounting possible	Yes	24 VDC	FGRM-S51-24-LED

 = Highlighted **Rapid Delivery** products are available for shipment today or within **FIVE** days.

Компания «Life Electronics» занимается поставками электронных компонентов импортного и отечественного производства от производителей и со складов крупных дистрибьюторов Европы, Америки и Азии.

С конца 2013 года компания активно расширяет линейку поставок компонентов по направлению коаксиальный кабель, кварцевые генераторы и конденсаторы (керамические, пленочные, электролитические), за счёт заключения дистрибьюторских договоров

Мы предлагаем:

- Конкурентоспособные цены и скидки постоянным клиентам.
- Специальные условия для постоянных клиентов.
- Подбор аналогов.
- Поставку компонентов в любых объемах, удовлетворяющих вашим потребностям.
- Приемлемые сроки поставки, возможна ускоренная поставка.
- Доставку товара в любую точку России и стран СНГ.
- Комплексную поставку.
- Работу по проектам и поставку образцов.
- Формирование склада под заказчика.
- Сертификаты соответствия на поставляемую продукцию (по желанию клиента).
- Тестирование поставляемой продукции.
- Поставку компонентов, требующих военную и космическую приемку.
- Входной контроль качества.
- Наличие сертификата ISO.

В составе нашей компании организован Конструкторский отдел, призванный помогать разработчикам, и инженерам.

Конструкторский отдел помогает осуществить:

- Регистрацию проекта у производителя компонентов.
- Техническую поддержку проекта.
- Защиту от снятия компонента с производства.
- Оценку стоимости проекта по компонентам.
- Изготовление тестовой платы монтаж и пусконаладочные работы.



Тел: +7 (812) 336 43 04 (многоканальный)

Email: org@lifeelectronics.ru