



# HMC401QS16G / 401QS16GE

## Ku-Band MMIC VCO with DIVIDE-BY-8, 13.2 - 13.5 GHz

### Typical Applications

Low noise MMIC VCO w/Divide-by-8 for Ku-Band applications such as:

- Point-to-Point Radios
- Point-to-Multi-Point Radios / LMDS
- VSAT

### Features

- Pout: -7 dBm
- Phase Noise: -105 dBc/Hz @100 KHz Typ.
- No External Resonator Needed
- Single Supply: 5V @ 290 mA
- QSOP16G SMT Package

### Functional Diagram

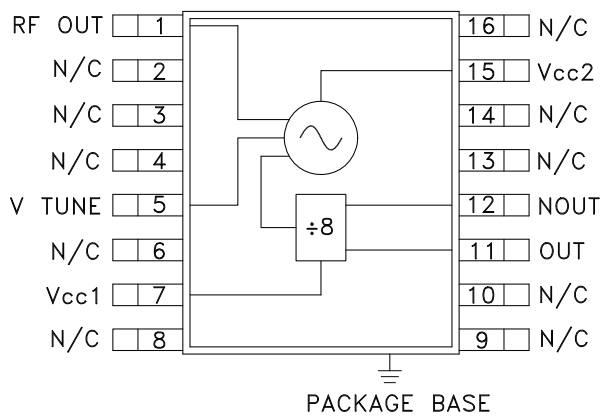

### General Description

The HMC401QS16G & HMC401QS16GE are GaAs InGaP Heterojunction Bipolar Transistor (HBT) MMIC VCOs. The HMC401QS16G & HMC401QS16GE integrate resonators, negative resistance devices, varactor diodes and divide-by-8 prescalers. The VCO's phase noise performance is excellent over temperature, shock, and process due to the oscillator's monolithic structure. Power output is -7 dBm typical from a 5V supply voltage. The voltage controlled oscillator is packaged in a low cost, surface mount 16 leaded QSOP package with an exposed base for improved RF and thermal performance.

### Electrical Specifications, $T_A = +25^\circ C$ , $V_{cc1}, V_{cc2} = +5V$

Parameter	Min.	Typ.	Max.	Units
Frequency Range	13.2 - 13.5			GHz
Power Output	FR Output	-10	-7	dBm
	Divided Output	-9	-6	dBm
SSB Phase Noise @ 100 kHz Offset, $V_{tune} = +5V$ @ RF Output		-105		dBc/Hz
Tune Voltage	$V_{tune}$	0	10	V
Supply Current	$I_{cc1}$ (Digital)	65		mA
	$I_{cc2}$ (RF)		225	mA
Tune Port Leakage Current ( $V_{tune} = 10V$ )			10	$\mu A$
Output Return Loss		2		dB
Harmonics/Subharmonics	1/2	-7		dBc
	3/2	-28		dBc
	2nd	-17		dBc
	5/2	-40		dBc
Pulling (into a 2.0:1 VSWR)		0.6		MHz pp
Pushing @ $V_{tune} = 5V$		5		MHz/V
Frequency Drift Rate		1.5		MHz/ $^\circ C$

For price, delivery, and to place orders, please contact Hittite Microwave Corporation:  
 20 Alpha Road, Chelmsford, MA 01824 Phone: 978-250-3343 Fax: 978-250-3373  
 Order On-line at [www.hittite.com](http://www.hittite.com)

# HMC401QS16G / 401QS16GE

## Ku-Band MMIC VCO with DIVIDE-BY-8, 13.2 - 13.5 GHz

**Frequency vs. Tuning Voltage,  $T = 25^\circ\text{C}$**

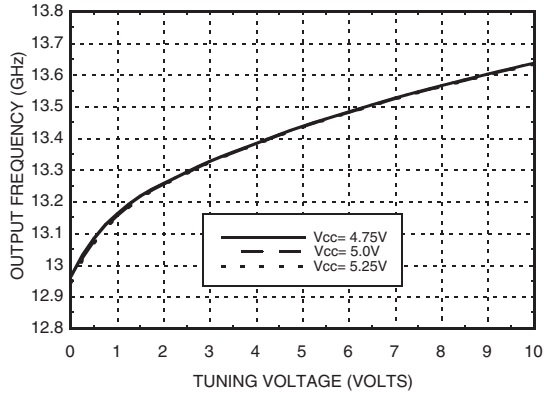

**Frequency vs. Tuning Voltage,  $V_{cc} = +5V$**

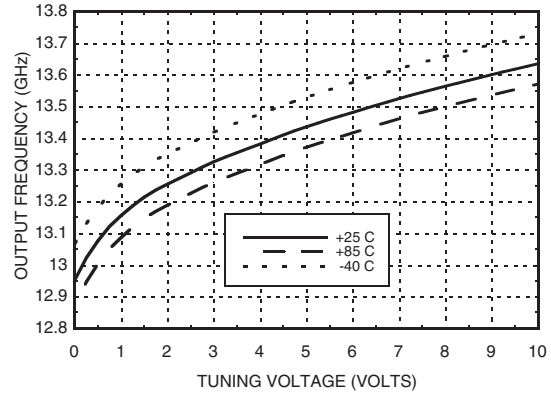

**Sensitivity vs. Tuning Voltage,  $V_{cc} = +5V$**

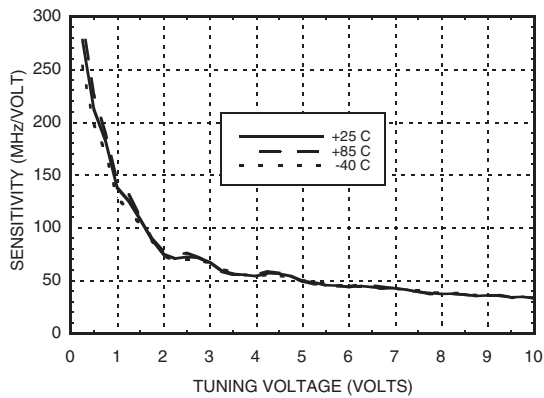

**Output Power vs. Tuning Voltage,  $V_{cc} = +5V$**

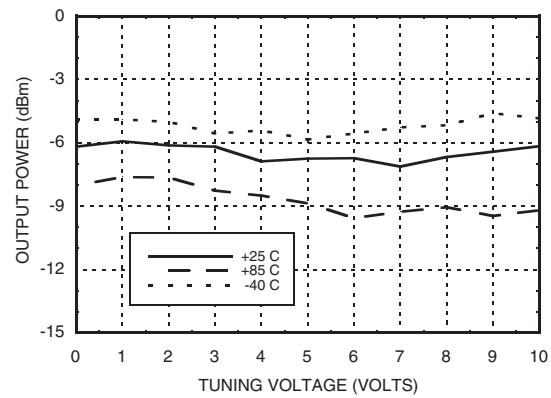

**SSB Phase Noise vs. Tuning Voltage**

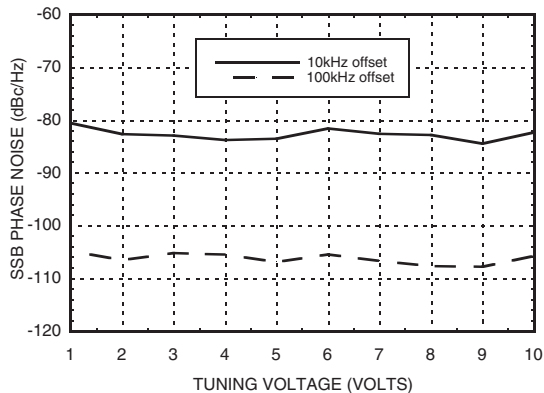

**Phase Noise @  $V_{tune} = 5V$**

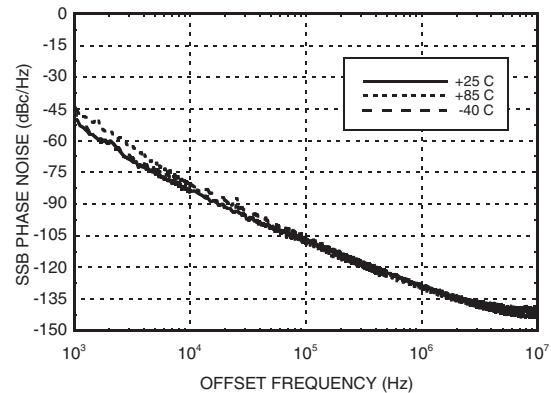



**HMC401QS16G / 401QS16GE**

**Ku-Band MMIC VCO with  
DIVIDE-BY-8, 13.2 - 13.5 GHz**

**Divided Frequency  
vs. Tuning Voltage, Vcc= +5V**

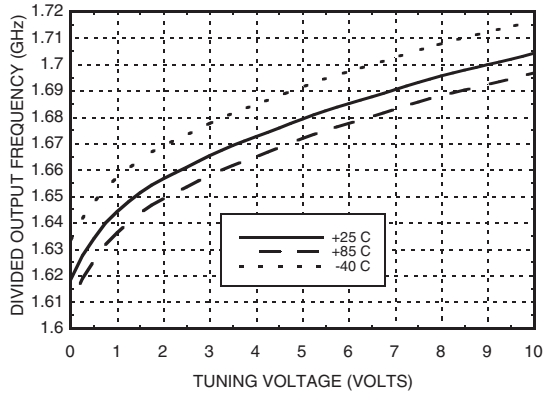

**Divided Output  
Power vs. Tuning Voltage, Vcc= +5V**

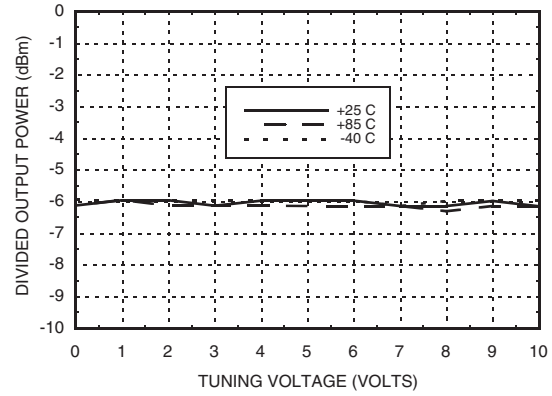

**Divided Output  
SSB Phase Noise @ Vtune= 5V**

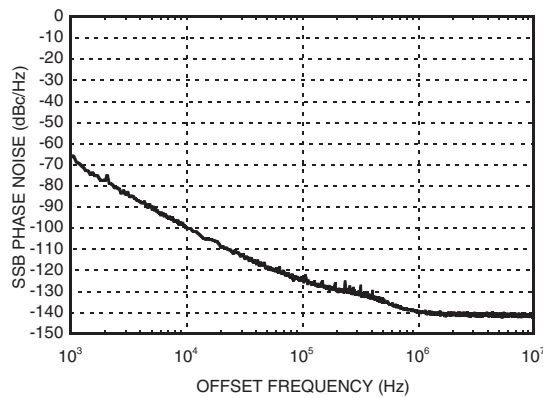



### Absolute Maximum Ratings

Vcc1, Vcc2	5.5 V
Storage Temperature	-65 to +150 °C
Operating Temperature	-40 to +85 °C
Vtune	0 to 11V Max.
ESD Sensitivity (HBM)	Class 1A

### Typical Supply Current vs. Vcc

Vcc (V)	Icc (mA)
4.75	260
5.0	290
5.25	315

Note: VCO will operate over full voltage range shown above.



**ELECTROSTATIC SENSITIVE DEVICE  
OBSERVE HANDLING PRECAUTIONS**

### Outline Drawing

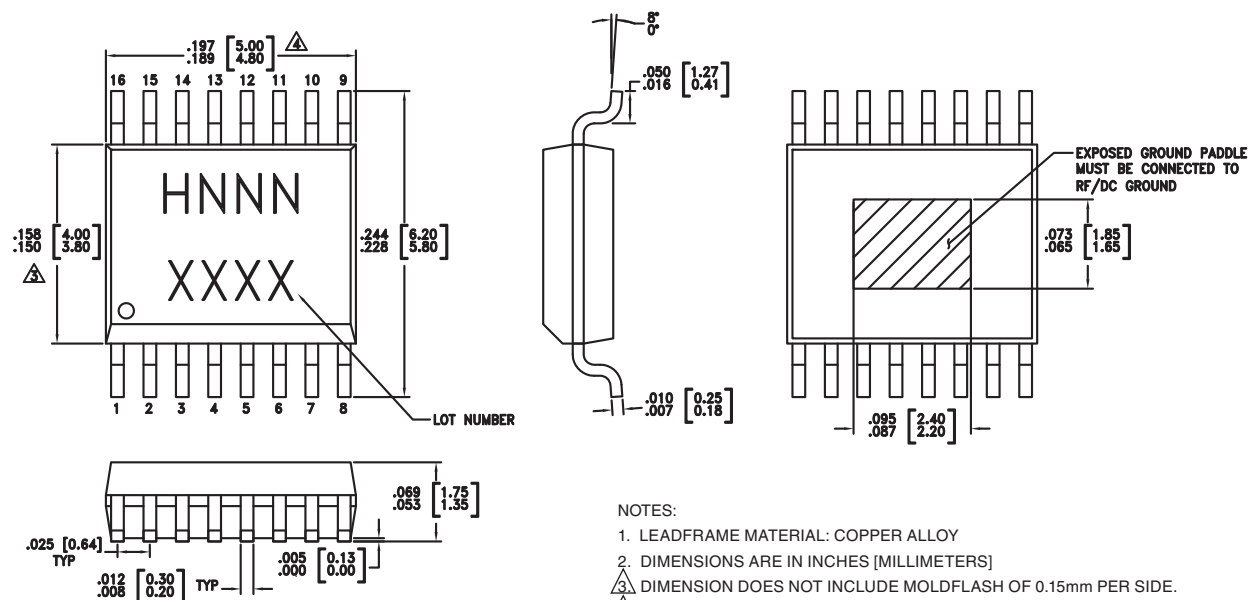

### Package Information

Part Number	Package Body Material	Lead Finish	MSL Rating	Package Marking <sup>[3]</sup>
HMC401QS16G	Low Stress Injection Molded Plastic	Sn/Pb Solder	MSL1 <sup>[1]</sup>	H401 XXXX
HMC401QS16GE	RoHS-compliant Low Stress Injection Molded Plastic	100% matte Sn	MSL1 <sup>[2]</sup>	H401 XXXX

[1] Max peak reflow temperature of 235 °C



[2] Max peak reflow temperature of 260 °C

[3] 4-Digit lot number XXXX

For price, delivery, and to place orders, please contact Hittite Microwave Corporation:  
 20 Alpha Road, Chelmsford, MA 01824 Phone: 978-250-3343 Fax: 978-250-3373  
 Order On-line at [www.hittite.com](http://www.hittite.com)

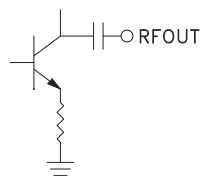
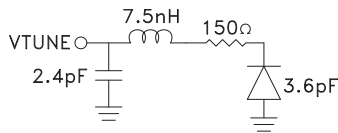
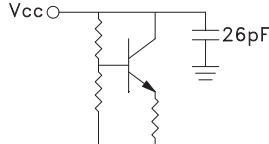
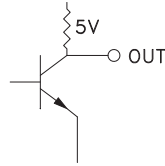
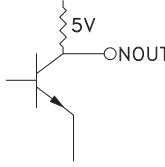

### Pin Descriptions

Pin Number	Function	Description	Interface Schematic
1	RFOUT	RF output (AC coupled).	
2, 3, 4, 6, 8, 9, 10, 13, 14, 16	N/C	No Connection	
5	VTUNE	Control Voltage Input. Modulation port bandwidth dependent on drive source impedance.	
7, 15	VCC1, VCC2	Supply Voltage, 5V	
11	OUT	Divided Output	
12	NOOUT	Divided Output 180° output phase with pin 11.	
	GND	Package bottom has an exposed metal paddle that must be RF & DC grounded.	

### Evaluation PCB

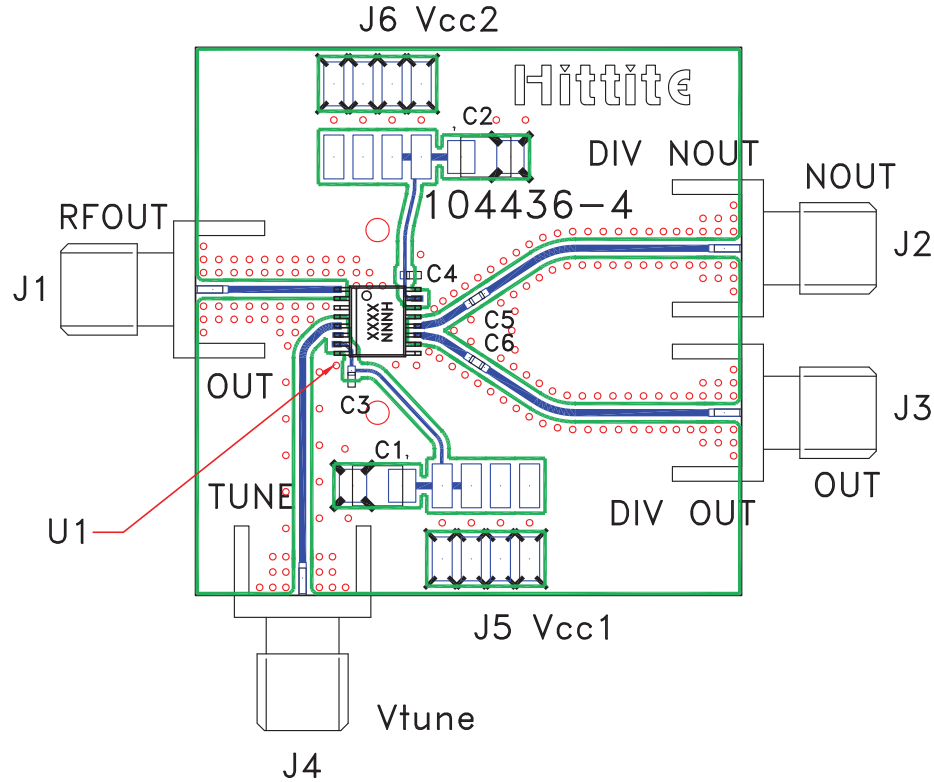

### List of Materials for Evaluation PCB 104711 <sup>[1]</sup>

Item	Description
J1 - J4	PCB Mount SMA RF Connector
J5 - J6	2 mm DC Header
C1 - C2	10 $\mu$ F Tantalum Capacitor
C3 - C6	1,000 pF Capacitor, 0402 Pkg.
U1	HMC401QS16G / HMC401QS16GE VCO
PCB [2]	104436 Eval Board

[1] Reference this number when ordering complete evaluation PCB

[2] Circuit Board Material: Rogers 4350

The circuit board used in the final application should use RF circuit design techniques. Signal lines should have 50 ohm impedance while the package ground leads and backside ground slug should be connected directly to the ground plane similar to that shown. A sufficient number of via holes should be used to connect the top and bottom ground planes. The evaluation circuit board shown is available from Hittite upon request.



### Typical Application Circuit

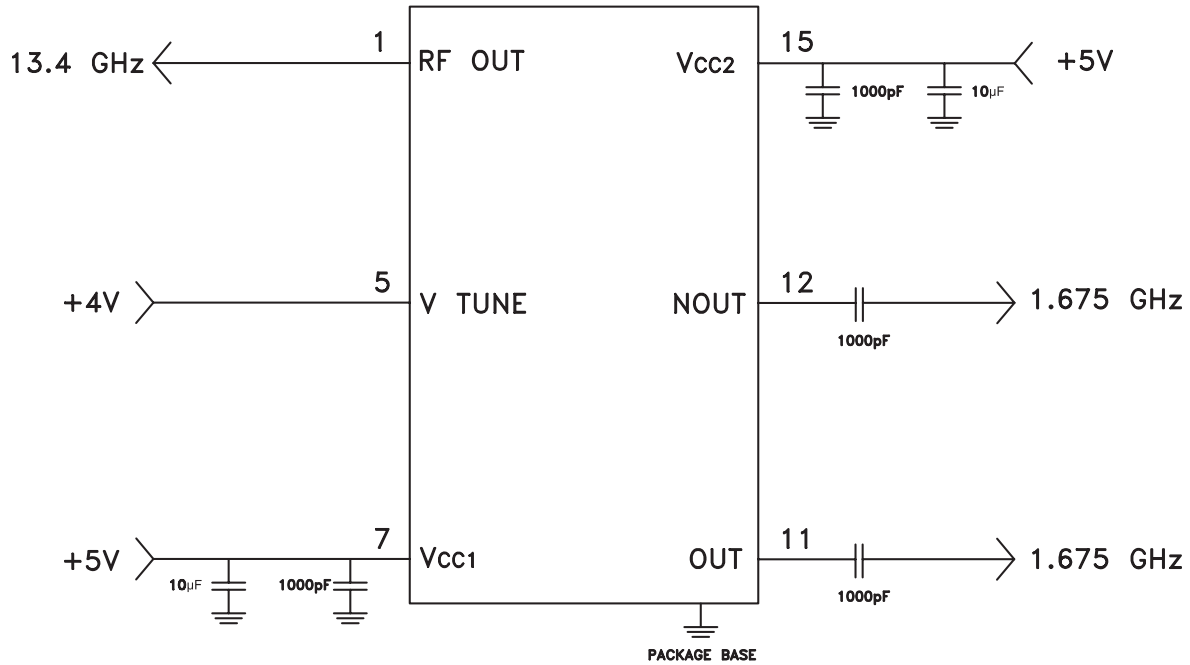



## HMC401QS16G / 401QS16GE

*Ku-Band MMIC VCO with  
DIVIDE-BY-8, 13.2 - 13.5 GHz*

**Notes:**



Компания «Life Electronics» занимается поставками электронных компонентов импортного и отечественного производства от производителей и со складов крупных дистрибьюторов Европы, Америки и Азии.

С конца 2013 года компания активно расширяет линейку поставок компонентов по направлению коаксиальный кабель, кварцевые генераторы и конденсаторы (керамические, пленочные, электролитические), за счёт заключения дистрибьюторских договоров

Мы предлагаем:

- Конкурентоспособные цены и скидки постоянным клиентам.
- Специальные условия для постоянных клиентов.
- Подбор аналогов.
- Поставку компонентов в любых объемах, удовлетворяющих вашим потребностям.
- Приемлемые сроки поставки, возможна ускоренная поставка.
- Доставку товара в любую точку России и стран СНГ.
- Комплексную поставку.
- Работу по проектам и поставку образцов.
- Формирование склада под заказчика.
- Сертификаты соответствия на поставляемую продукцию (по желанию клиента).
- Тестирование поставляемой продукции.
- Поставку компонентов, требующих военную и космическую приемку.
- Входной контроль качества.
- Наличие сертификата ISO.

В составе нашей компании организован Конструкторский отдел, призванный помогать разработчикам, и инженерам.

Конструкторский отдел помогает осуществить:

- Регистрацию проекта у производителя компонентов.
- Техническую поддержку проекта.
- Защиту от снятия компонента с производства.
- Оценку стоимости проекта по компонентам.
- Изготовление тестовой платы монтаж и пусконаладочные работы.



Тел: +7 (812) 336 43 04 (многоканальный)

Email: [org@lifeelectronics.ru](mailto:org@lifeelectronics.ru)