

85mΩ High Function Power Switch

■ GENERAL DESCRIPTION

The XC8107 series is a P-channel MOSFET power switch IC with a low ON resistance. A current limit, reverse current prevention (prevents reverse current from V_{OUT} to V_{IN}), soft start, thermal shutdown, and an under voltage lockout (UVLO) are incorporated as protective functions. A flag function monitors the power switch status. The flag output has N-channel open drain configuration, and it outputs Low level signal when over-current or overheating is detected, or when the reverse current prevention is operated. The voltage level which is fed to CE pin determines the status of XC8107. The logic level of CE pin is selectable between either one of active high or active low.

■ APPLICATIONS

- Set Top Boxes
- Digital TVs
- PCs
- USB Ports/USB Hubs
- HDMI

■ FEATURES

Input Voltage	: 2.5V~5.5V
Output Current	: 2A
ON Resistance	: 85mΩ@ $V_{IN}=5.0V$ (TYP.) *USP-6C 100mΩ@ $V_{IN}=5.0V$ (TYP.) *SOT-25
Supply Current	: 40 μA @ $V_{IN}=5.0V$
Stand-by Current	: 0.1 μA (MAX.)
Flag Delay Time	: 7.5ms (TYP.) * At over-current detection : 4ms(TYP.) * At reverse voltage detection
Protection Circuit	: Reverse Current Prevention Thermal Shutdown Under Voltage Lockout(UVLO) Soft-start
Functions	: Flag Output CE Pin Input Logic Selectable
Current Limit Response Time	: 2 μs(TYP.) *Reference value
Operating Ambient Temperature	: -40°C~+105°C
Packages	: USP-6C, SOT-25
Environmentally Friendly	: EU RoHS Compliant, Pb Free

■ TYPICAL APPLICATION CIRCUIT

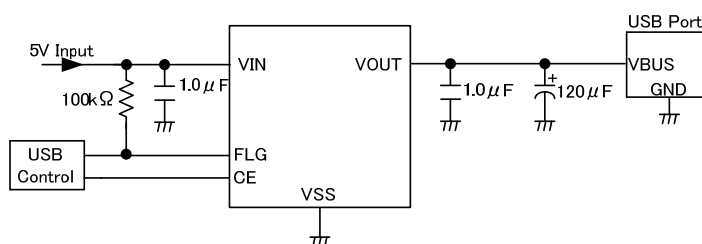

■ TYPICAL PERFORMANCE CHARACTERISTICS

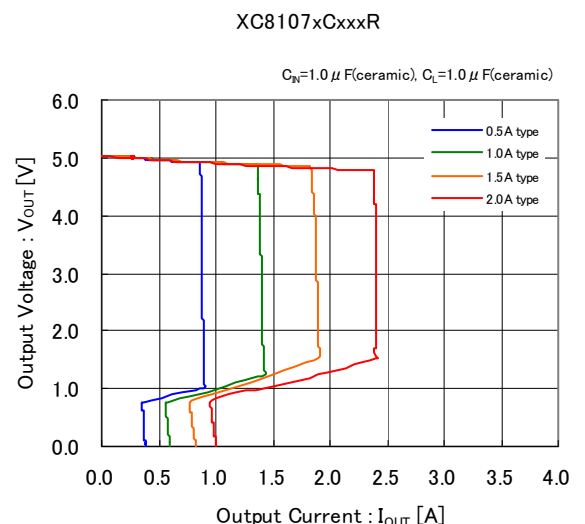

■ BLOCK DIAGRAM

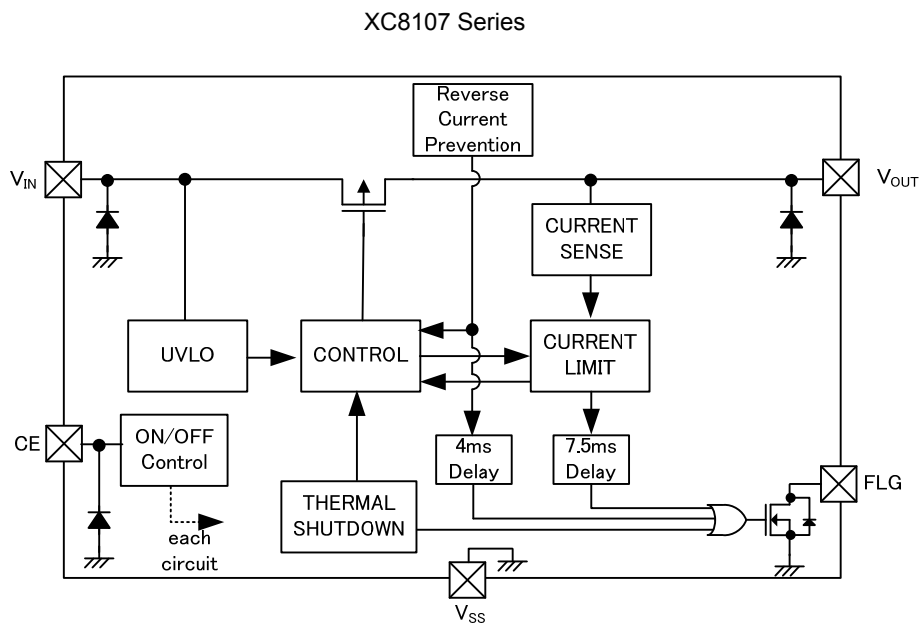

* Diodes inside the circuit are an ESD protection diode and a parasitic diode.

■ PRODUCT CLASSIFICATION

● Ordering Information

XC8107①②③④⑤⑥-⑦

DESIGNATOR	ITEM	SYMBOL	DESCRIPTION
①	CE Logic	A	Refer to Selection Guide
		B	
②	Protection Circuits Type	C	
		D	
③④	Maximum Output Current	05	0.5A
		10	1.0A
		15	1.5A
		20	2.0A
⑤⑥-⑦ (*1)	Packages	ER-G	USP-6C (3,000/Reel)
		MR-G	SOT-25 (3,000/Reel)

(*1) The "-G" suffix denotes Halogen and Antimony free as well as being fully RoHS compliant.

● Selection Guide

TYPE	CE LOGIC SELECTABLE	SOFT-START	CURRENT LIMITER
AC	Active High	Yes	Yes
AD	Active High	Yes	Yes
BC	Active Low	Yes	Yes
BD	Active Low	Yes	Yes

TYPE	UVLO	FLG OUTPUT	REVERSE CURRENT PREVENTION
AC	Yes	Yes	Yes
AD	Yes	Yes	Yes
BC	Yes	Yes	Yes
BD	Yes	Yes	Yes

TYPE	THERMAL SHUT DOWN	LATCH PROTECTION
AC	Yes	No
AD	Yes	Yes
BC	Yes	No
BD	Yes	Yes

PIN CONFIGURATION

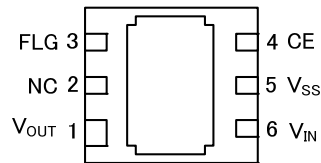

USP-6C
(BOTTOM VIEW)

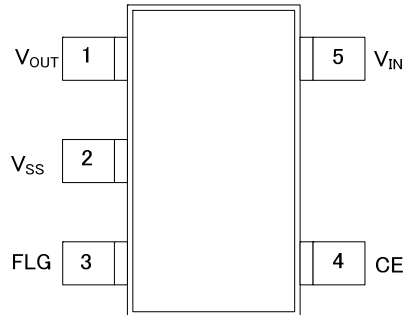

SOT-25
(TOP VIEW)

* The dissipation pad for the USP-6C packages should be solder-plated for mounting strength and heat dissipation. Please refer to the reference mount pattern and metal masking. The dissipation pad should be connected to the V_{SS} (No. 5) pin.

PIN ASSIGNMENT

PIN NUMBER		PIN NAME	FUNCTIONS
USP-6C	SOT-25		
1	1	V_{OUT}	Output
2	-	NC	No connection
3	3	FLG	Fault Report
4	4	CE	ON/OFF Control
5	2	V_{SS}	Ground
6	5	V_{IN}	Power Input

FUNCTION

TYPE	PIN NAME	SIGNAL	STATUS
A	CE	H	Active
		L	Stand-by
		OPEN	Undefined State ^(*)
B		H	Stand-by
		L	Active
		OPEN	Undefined State ^(*)

* Avoid leaving the CE pin open; set to any fixed voltage.

■ ABSOLUTE MAXIMUM RATINGS

Ta=25°C

PARAMETER		SYMBOL	RATINGS	UNITS
Input Voltage		V _{IN}	-0.3~+6.0	V
Output Voltage		V _{OUT}	-0.3~+6.0	V
Output Current		I _{OUT}	2.8	A
CE Input Voltage		V _{CE}	-0.3~+6.0	V
FLG Pin Voltage		V _{FLG}	-0.3~+6.0	V
FLG Pin Current		I _{FLG}	15	mA
Power Dissipation	USP-6C	Pd	120	mW
			1000 (PCB mounted) ^(*)2)	
	SOT-25		250	
			600 (PCB mounted) ^(*)2)	
Operating Ambient Temperature		Topr	-40~+105	°C
Storage Temperature		Tstg	-55~+125	°C

* All voltages are described based on the V_{SS}.

(*)1 Use with I_{OUT} less than Pd/(V_{IN}-V_{OUT}).

(*)2 This is a reference data taken by using the test board. Please refer to page 24 and 25 for details.

ELECTRICAL CHARACTERISTICS

Ta=25°C

PARAMETER	SYMBOL	CONDITIONS	MIN.	TYP.	MAX.	UNITS	CIRCUIT	
Input Voltage	V_{IN}	-	2.5	-	5.5	V	①	
On Resistance	R_{ON}	USP-6C	$V_{IN}=3.3V^{(*)}$	-	100	110	mΩ	①
			$V_{IN}=5.0V^{(*)}$	-	85	104	mΩ	
		SOT-25	$V_{IN}=3.3V^{(*)}$	-	115	135	mΩ	
			$V_{IN}=5.0V^{(*)}$	-	100	120	mΩ	
Supply Current	I_{SS}	$V_{OUT}=OPEN$	-	40	75	μA	②	
Stand-by Current	I_{STBY}	$V_{IN}=5.5V, V_{OUT}=OPEN$ $V_{CE}=V_{SS}$ (XC8107A series) $V_{CE}=V_{IN}$ (XC8107B series)	-	0.01	1.0	μA	②	
Switch Leakage Current	I_{LEAK}	$V_{IN}=5.5V, V_{OUT}=0V$ $V_{CE}=V_{SS}$ (XC8107A series) $V_{CE}=V_{IN}$ (XC8107B series)	-	0.01	1.0	μA	②	
Current Limit	I_{LIMIT}	$V_{OUT}=V_{IN}-0.3V$, XC8107xx05 series	0.81	0.90	0.99	A	①	
		$V_{OUT}=V_{IN}-0.3V$, XC8107xx10 series	1.26	1.40	1.54	A		
		$V_{OUT}=V_{IN}-0.3V$, XC8107xx15 series	1.71	1.90	2.09	A		
		$V_{OUT}=V_{IN}-0.3V$, XC8107xx20 series	2.16	2.40	2.64	A		
Short-Circuit Current	I_{SHORT}	$V_{OUT}=0V$, XC8107xx05 series	-	0.45	-	A	①	
		$V_{OUT}=0V$, XC8107xx10 series	-	0.70	-	A		
		$V_{OUT}=0V$, XC8107xx15 series	-	0.95	-	A		
		$V_{OUT}=0V$, XC8107xx20 series	-	1.20	-	A		
Current Limit Circuit Response Time ^(*)2)	t_{CLR}	$V_{IN}=5.0V, V_{OUT}: OPEN \rightarrow 0V$ Measure from $V_{OUT}=0V$ to when current falls below a certain I_{LIMIT} value	-	2.0	-	μs	①	
CE "H" Level Voltage	V_{CEH}	$V_{IN}=5.5V$, XC8107A series	1.5	-	5.5	V	①	
		$V_{IN}=5.5V$, XC8107B series	-	-	0.8			
CE "L" Level Voltage	V_{CEL}	$V_{IN}=5.5V$, XC8107A series	-	-	0.8	V	①	
		$V_{IN}=5.5V$, XC8107B series	1.5	-	5.5			
CE "H" Level Current	I_{CEH}	$V_{IN}=5.5V, V_{CE}=5.5V$	-0.1	-	0.1	μA	①	
CE "L" Level Current	I_{CEL}	$V_{IN}=5.5V, V_{CE}=0V$	-0.1	-	0.1	μA	①	
UVLO Detected Voltage	V_{UVLOD}	$V_{IN}: 2.2V \rightarrow 1.7V$	1.8	1.9	2.0	V	①	
UVLO Released Voltage	V_{UVLOR}	$V_{IN}: 1.7V \rightarrow 2.2V$	1.9	2.0	2.1	V	①	
UVLO Hysteresis	V_{UHYS}	-	-	0.1	-	V	①	

NOTE:

Unless otherwise stated, $V_{IN}=5.0V, I_{OUT}=1mA, V_{CE}=V_{IN}$ (XC8107A series) or $V_{CE}=V_{SS}$ (XC8107B series)

(*) $I_{OUT}=0.25A$ (XC8107xx05 series), $I_{OUT}=0.5A$ (XC8107xx10 series), $I_{OUT}=0.75A$ (XC8107xx15series), $I_{OUT}=1.0A$ (XC8107xx20 series)

(*)2) Design reference value. This parameter is provided only for reference.

■ ELECTRICAL CHARACTERISTICS (Continued)

Ta=25°C

PARAMETER	SYMBOL	CONDITIONS	MIN.	TYP.	MAX.	UNITS	CIRCUIT	
turn-on time	t _{DLY(ON)}	R _{LOAD} =10Ω, V _{CE} =0V→2.2V	-	0.60	1.00	ms	①	
turn-off time	t _{DLY(OFF)}	R _{LOAD} =10Ω, V _{CE} =2.2V→0V	-	0.08	0.13	ms	①	
FLG output FET On-resistance	R _{FLG}	I _{FLG} =10mA, V _{OUT} =5.5V	-	15	20	Ω	③	
FLG output FET Leakage Current	I _{FOFF}	V _{IN} =5.5V, V _{FLG} =5.5V, V _{OUT} =OPEN	-	0.01	0.1	μA	③	
FLG delay time	t _{FD1}	over-current condition	6.5	7.5	8.5	ms	①	
	t _{FD2}	reverse-voltage condition	2.7	4.0	4.7	ms	①	
Reverse Current	I _{REV}	V _{IN} =0V, V _{OUT} =5.5V V _{CE} =5.0V (XC8107A series) V _{CE} =V _{SS} (XC8107B series)	-	0.1	1.0	μA	①	
Reverse Current Prevention Detect Voltage	V _{REV_D}	V _{IN} : 5.0V→4.7V V _{OUT} =5.0V	SOT-25	-	170	-	mV	①
			USP-6C	-	140	-		
Thermal Shutdown Detect Temperature	T _{TSD}	Junction Temperature	-	150	-	°C	①	
Thermal Shutdown Release Temperature	T _{TSR}	Junction Temperature	-	130	-	°C	①	
Thermal Shutdown Hysteresis Width	T _{HYS}	Junction Temperature	-	20	-	°C	①	

NOTE:

Unless otherwise stated, V_{IN}=5.0V, I_{OUT}=1mA, V_{CE}=V_{IN} (XC8107A series) or V_{CE}=V_{SS} (XC8107B series)

■ TIMING CHART

● turn-on time, turn-off time

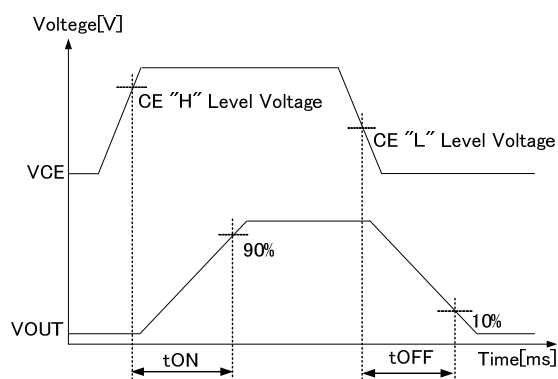

XC8107 Series, Type A

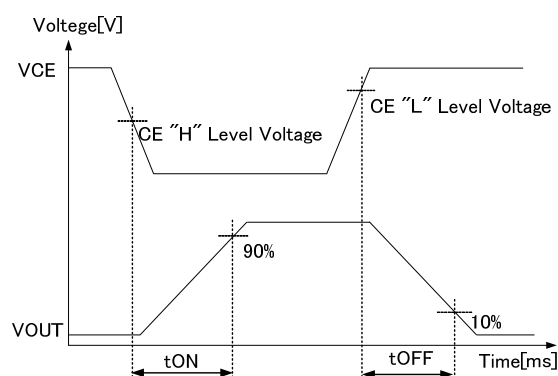

XC8107 Series, Type B

TEST CIRCUITS

$C_{IN}=1.0\ \mu\text{F}$, $C_L=1.0\ \mu\text{F}$

1) CIRCUIT①

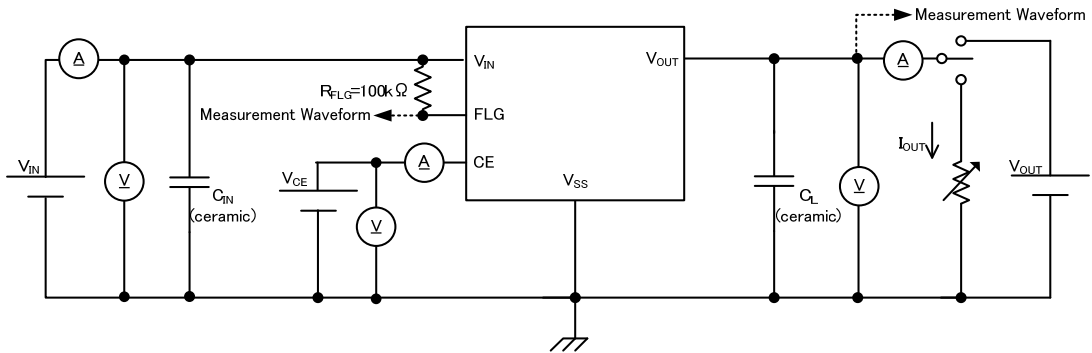

2) CIRCUIT②

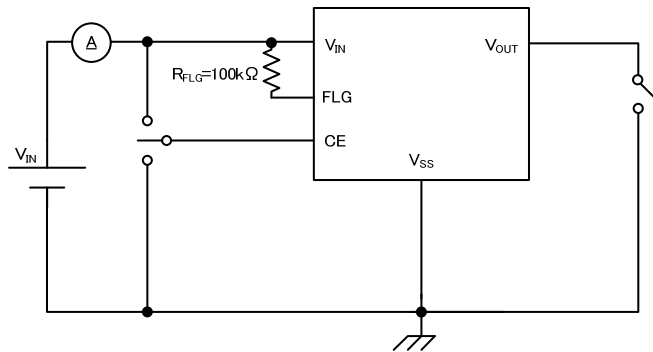

3) CIRCUIT③

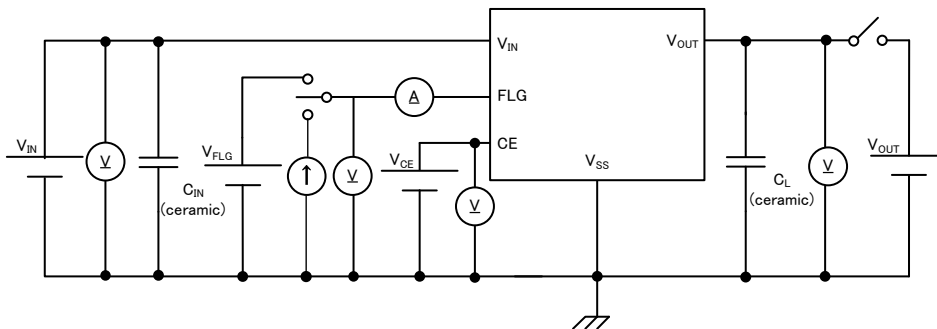

■ OPERATIONAL EXPLANATION

The XC8107 series is a P-channel MOSFET power switch IC. The XC8107 series consists of a CE circuit, UVLO circuit, thermal shutdown circuit, current limiter circuit, reverse current prevention circuit, control block and others. The gate voltage of the power switch transistor is controlled with control block. The current limiter circuit and reverse current prevention circuit will operate based on the output voltage and output current. (See the BLOCK DIAGRAM below)

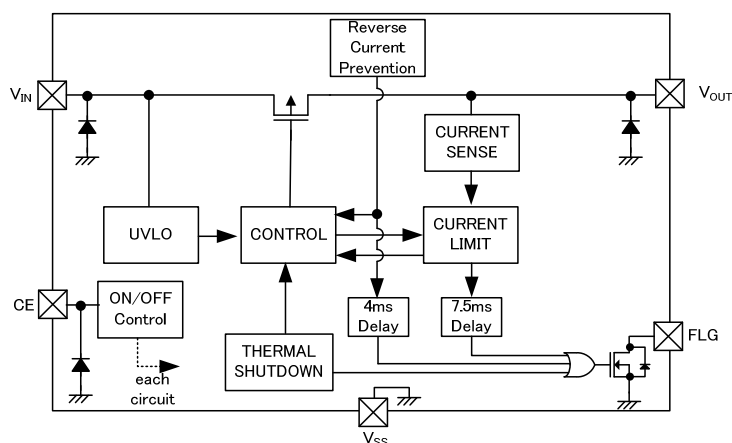

BLOCK DIAGRAM (XC8107 Series)

<CE Pin>

The voltage level which is fed to CE pin controls the status of this IC. If either “H” level or “L” level which is defined as the electrical specification is fed to CE pin, then XC8107 can operate in standard manner. However, if the middle voltage which is neither “H” level nor “L” level is fed to CE pin, the consumption current will increase due to the shoot-through current at internal circuits. Also if CE pin is open, the status of XC8107 cannot be fixed and the behavior will be unstable.

<Thermal Shutdown>

For protection against heat damage of the ICs, thermal shutdown function is built in. When the internal junction temperature reaches the temperature limit, the thermal shutdown circuit operates and the power switch transistor will turn OFF. The IC resumes its operation when the thermal shutdown function is released and the IC’s operation is automatically restored because the junction temperature drops to the level of the thermal shutdown release temperature. When the thermal shutdown circuit detects higher junction temperature than the detect temperature, the voltage level of FLG pin is low level. When the thermal shutdown circuit detects lower junction temperature than the release temperature, the thermal shutdown function is released and the voltage level of FLG pin is high level.

<Under Voltage Lockout (UVLO) >

When the V_{IN} pin voltage goes down to lower voltage than UVLO detected voltage, the power switch transistor turns OFF by UVLO function in order to prevent false output caused by unstable operation of the internal circuitry. When the V_{IN} pin voltage goes up to higher voltage than UVLO released voltage, the UVLO function is released and the power switch transistor can turn ON.

<Soft-start Function>

The soft-start circuit can reduce the in-rush current charged on the output capacitor when IC starts up. Additionally, due to the reduction of the in-rush current, the circuit can reduce the fluctuation of the input voltage as well. The soft-start time is optimized internally and defined as turn-on time. (TYP: 0.6ms)

■ OPERATIONAL EXPLANATION (Continued)

<Current limiter, short-circuit protection>

When the output current reaches the current limit value, the constant current limiter circuit activates and as a result, the output voltage goes down.

If the short circuit comes at the V_{OUT} pin, the output current is limited to the current which is specified as the short-circuit current value. If the over-current state lasts for 7.5ms (TYP.), the FLG pin changes to Low level output.

Two types are available for the current limiter circuit: an auto recovery type (product type C) and a latch off type (product type D). After the current limiter circuit activates and the FLG pin outputs low level, the operation is different between these two types.

The auto recovery type continuously limits the output current by the current limit value. When the over-current status finishes and the status of that the output current is less than the current limit value continues for 7.5ms (TYP.) or more, the voltage of FLG pin goes up "H" level again.

The latch off type turns off the power switch transistor after the FLG pin outputs Low level. The off state is maintained regardless of whether the over-current state is released.

Latch operation is released by turning off the IC with the CE pin signal and then restarting, or by lowering the input voltage below the UVLO detected voltage once and after that raising it higher than UVLO released voltage.

<Reverse current prevention>

An internal circuit is built in that prevents reverse current from the V_{OUT} pin to the V_{IN} pin. When the difference between input voltage and V_{OUT} pin voltage is higher than the detect voltage set internally, the reverse current prevention circuit activates, and the power switch transistor turns off, then the reverse current from the V_{OUT} pin to the V_{IN} pin is reduced to 0.1 μ A (TYP.).

If the reverse-voltage state lasts for 4ms (TYP.), the FLG pin changes to Low level output.

Two types are available for the reverse current prevention circuit: the auto recovery type (product type C) and the latch off type (product type D). After the reverse current prevention circuit activates and the FLG pin outputs low level, the operation is different between these two types.

On the auto recovery type, when the output voltage drops below the input voltage, the reverse current prevention circuit stops immediately, and the power switch transistor turns on again. If the output voltage remains lower than the input voltage for 4ms (TYP.), the FLG pin returns to High level output.

On the latch off type, the power switch transistor remains in the off state even if the reverse voltage state is released. Latch operation is released by turning off the IC with the CE pin signal and then restarting, or by lowering the input voltage below the UVLO detected voltage once and after that raising it higher than UVLO released voltage.

■ OPERATIONAL EXPLANATION (Continued)

<Flag function>

The flag circuit is built in which monitors the state of the power switch.

The FLG pin outputs Low level when the reverse current prevention function is operating. A resistance of 10kΩ to 100kΩ is recommended for the FLG pin pull-up resistance.

Auto recovery type (product type C)

Protective function	FLG pin Low level output	Return to FLG pin High level output
Current limiter	7.5ms after over-current detection	7.5ms after over-current release
Reverse current prevention	4.0ms after reverse voltage detection	4.0ms after reverse voltage release
Thermal shutdown	Same time as overheat state is detected	Same time as overheat state is released

Latch off type (product type D)

Protective function	FLG pin Low level output	Return to FLG pin High level output
Current limiter	7.5ms after over-current detection	When latch operation is released
Reverse current prevention	4.0ms after reverse voltage detection	When latch operation is released
Thermal shutdown	Same time as overheat state is detected	Same time as overheat state is released

■ NOTES ON USE

1. For the phenomenon of temporal and transitional voltage decrease or voltage increase, the IC may be damaged or deteriorated if IC is used beyond the absolute MAX. specifications.
2. Where wiring impedance is high, operations may become unstable due to noise depending on output current.
Please keep the resistance low between V_{IN} and V_{SS} wiring in particular.
3. Please place the input capacitor (C_{IN}) and the output capacitor (C_L) as close to the IC as possible.
For the input or output capacitor, a capacitance of $1.0 \mu F$ or higher is recommended.
4. When the voltage which is higher than the maximum input voltage is fed to the V_{IN} pin, and V_{OUT} is shorted to the V_{SS} level, in this case the short circuit may cause a fatal impact to operation for the IC. Please use within the operational voltage range.
5. Torex places an importance on improving our products and its reliability.
However, by any possibility, we would request user fail-safe design and post-aging treatment on system or equipment.

TYPICAL PERFORMANCE CHARACTERISTICS

(1) UVLO detect Voltage vs. Input Voltage

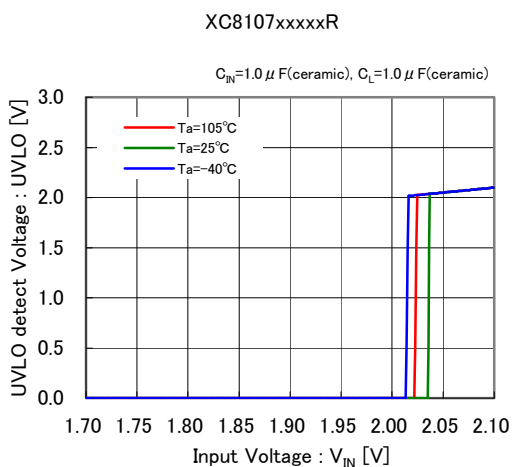

(2) UVLO release Voltage vs. Input Voltage

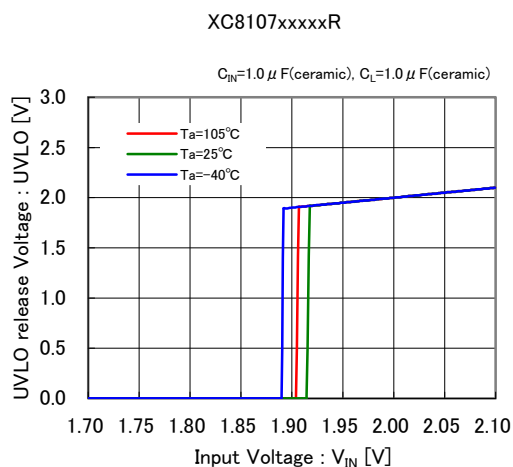

(3) UVLO threshold Voltage vs. Ambient Temperature

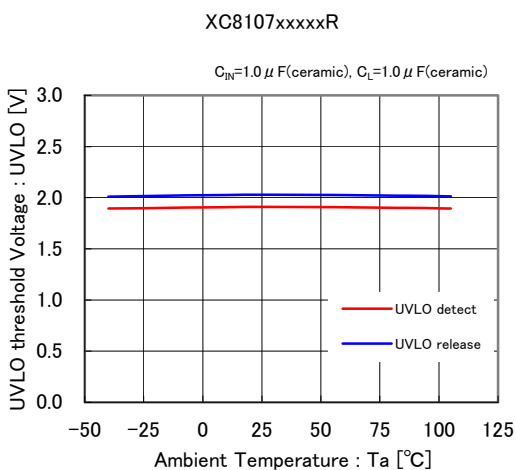

(4) Stand-by Current vs. Input Voltage

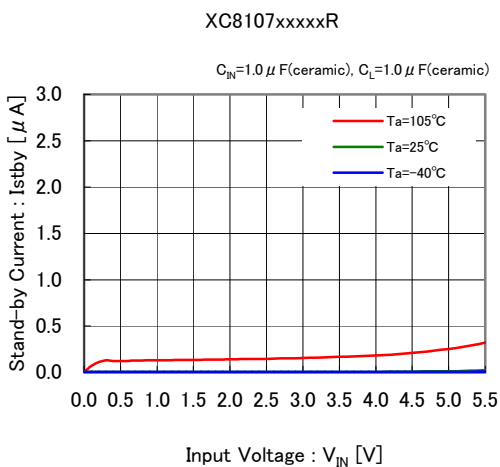

(5) Stand-by Current vs. Ambient Temperature

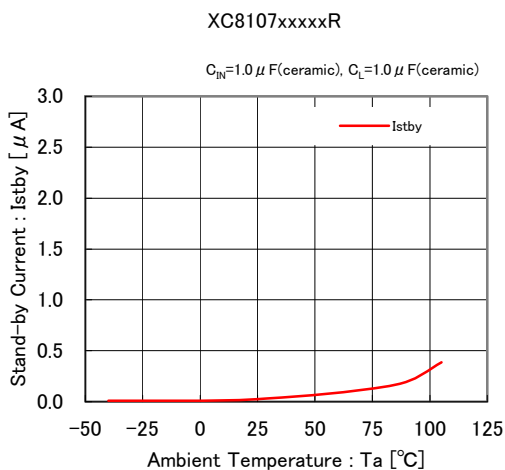

TYPICAL PERFORMANCE CHARACTERISTICS (Continued)

(6) Supply Current vs. Input Voltage (sweep up)

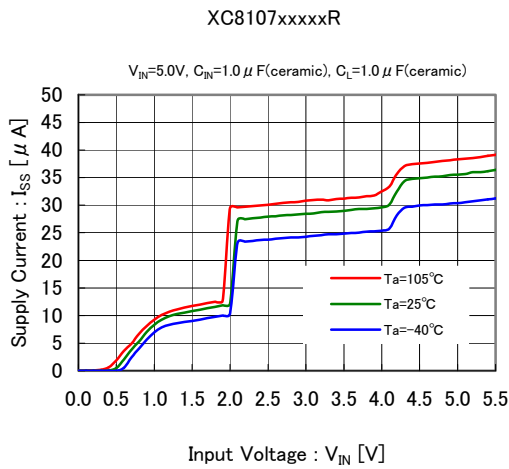

(7) Supply Current vs. Ambient Temperature

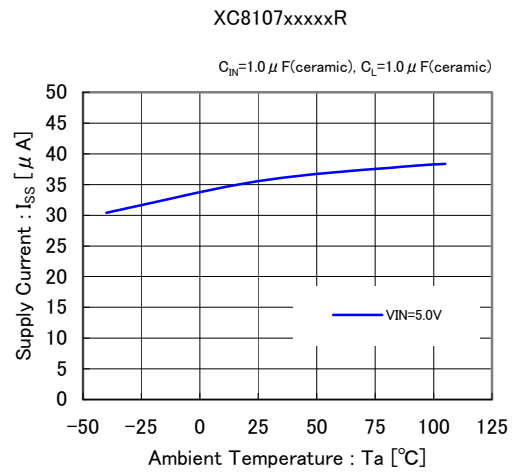

(8) CE "H" Level Voltage vs. Input Voltage

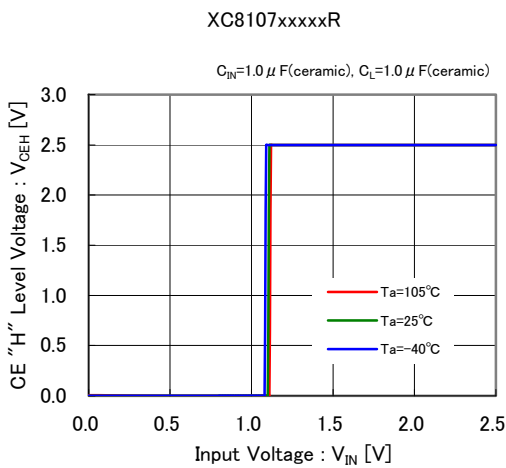

(9) CE "L" Level Voltage vs. Input Voltage

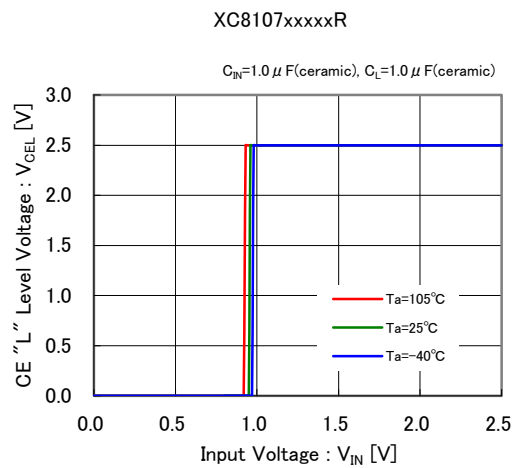

(10) CE threshold Voltage vs. Ambient Temperature

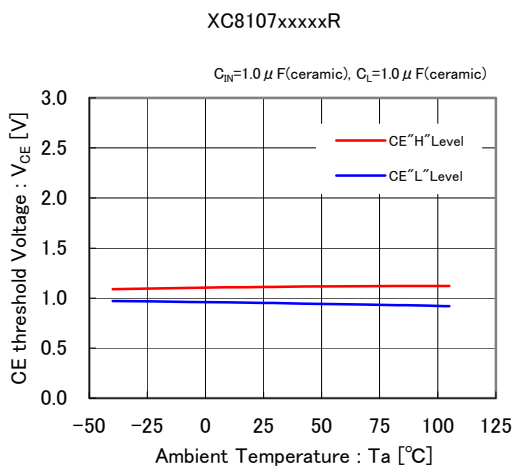

TYPICAL PERFORMANCE CHARACTERISTICS (Continued)

(11) On Resistance vs. Input Voltage (SOT-25)

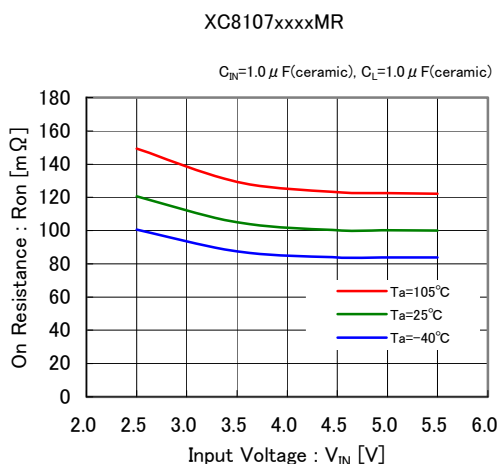

(12) On Resistance vs. Ambient Temperature (SOT-25)

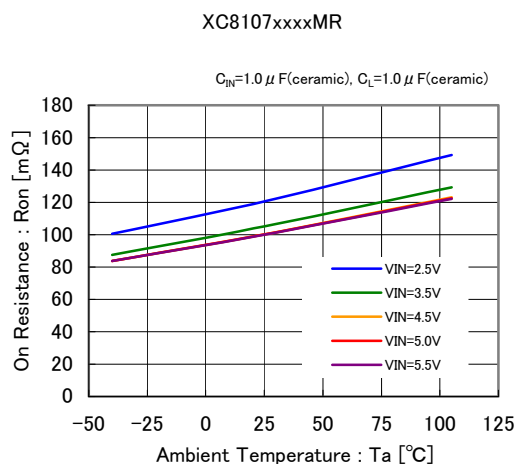

(13) On Resistance vs. Input Voltage (USP-6C)

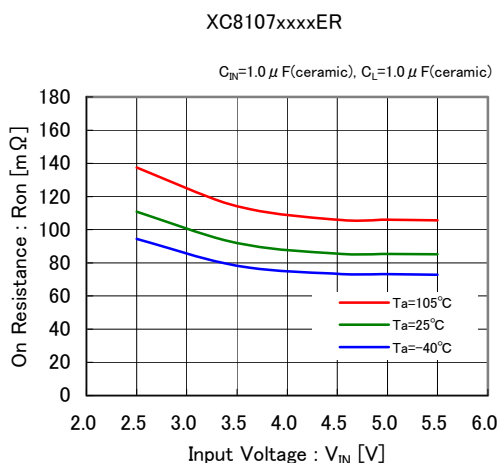

(14) On Resistance vs. Ambient Temperature (USP-6C)

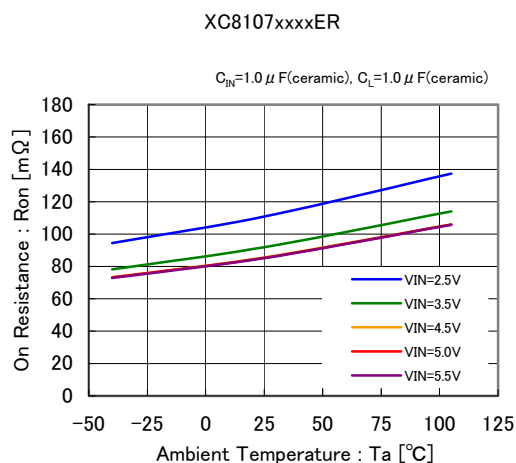

(15) turn-on time vs. Input Voltage

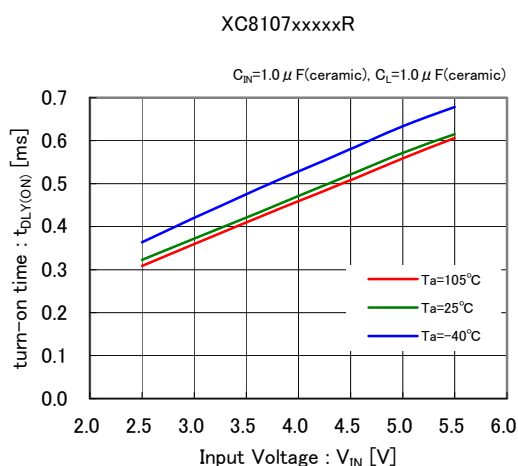

(16) turn-on time vs. Ambient Temperature

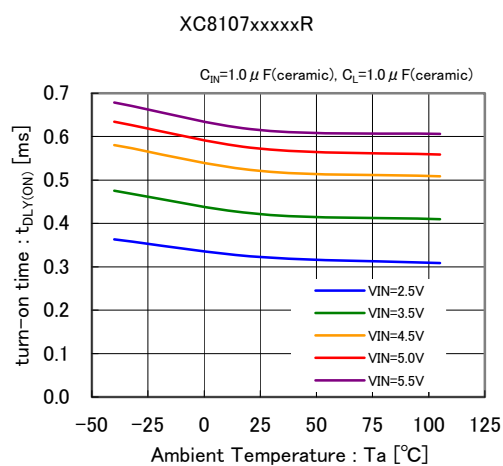

TYPICAL PERFORMANCE CHARACTERISTICS (Continued)

(17) turn-off time vs. Input Voltage

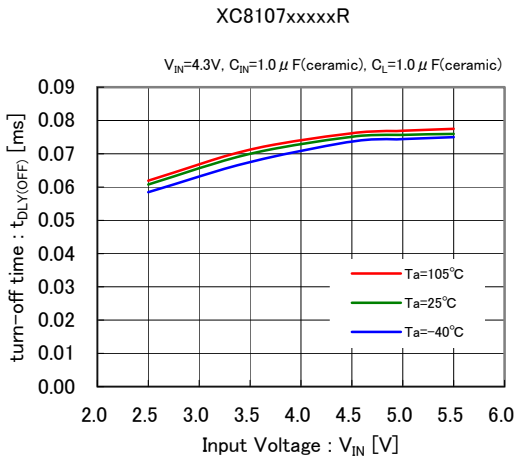

(18) turn-off time vs. Ambient Temperature

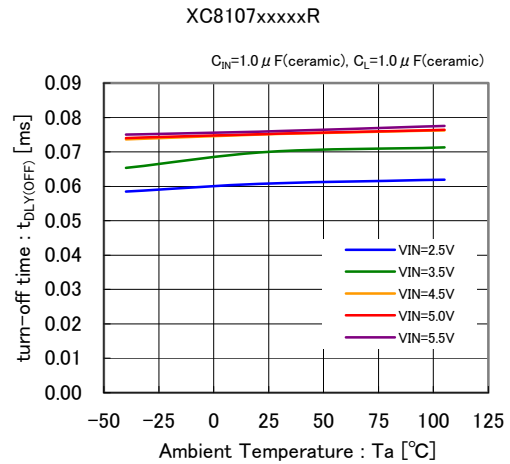

(19) FLG delay time over-current vs. Ambient Temperature

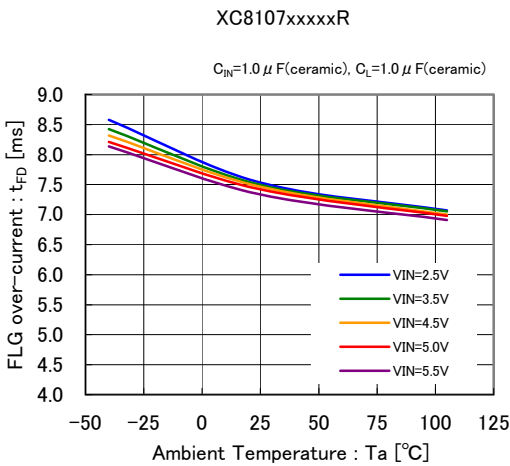

(20) FLG delay time reverse-voltage vs. Ambient Temperature

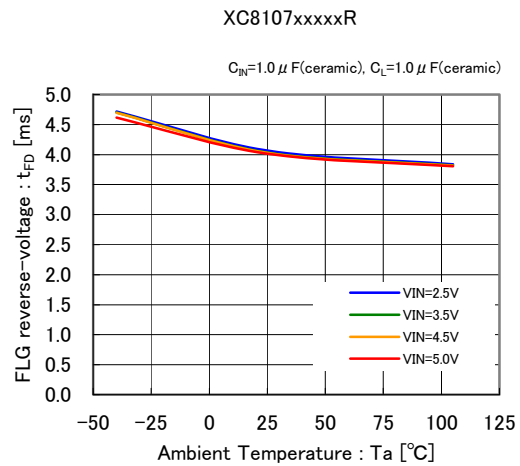

(21) Output Voltage vs. Output Current

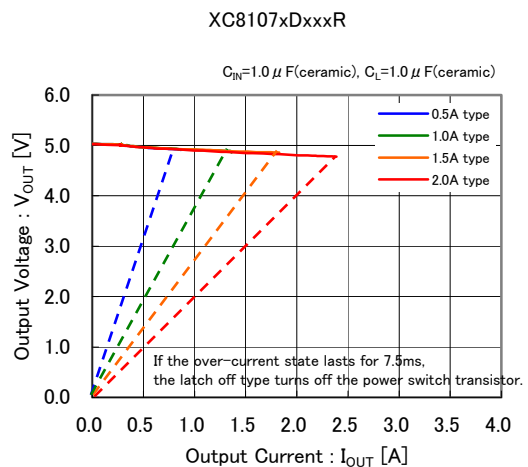
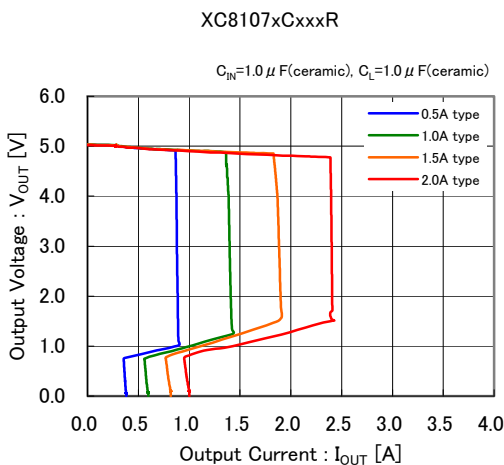

■ TYPICAL PERFORMANCE CHARACTERISTICS (Continued)

(22) turn-on Delay vs. Rise Time ($C_L=1.0\ \mu\text{F}$)

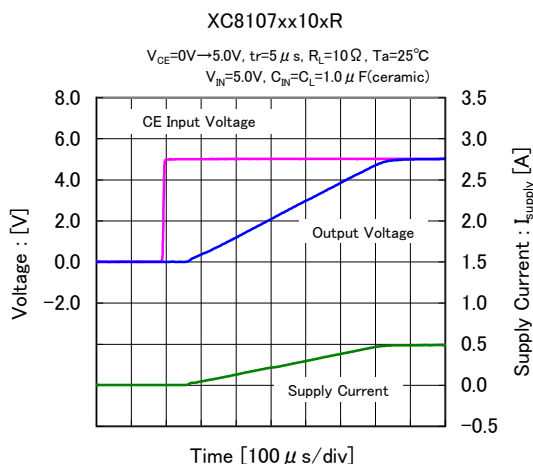

(23) turn-off Delay vs. Fall Time ($C_L=1.0\ \mu\text{F}$)

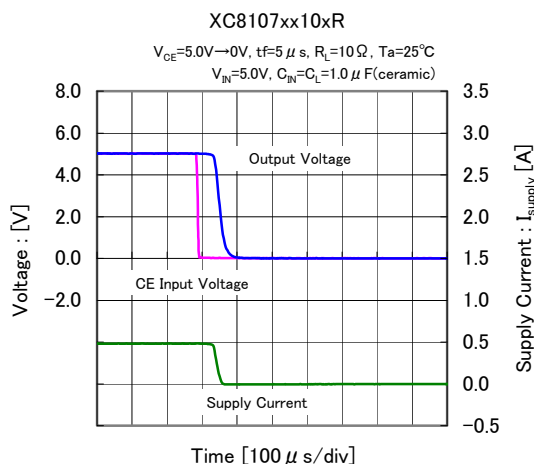

(24) turn-on Delay vs. Rise Time ($C_L=120\ \mu\text{F}$)

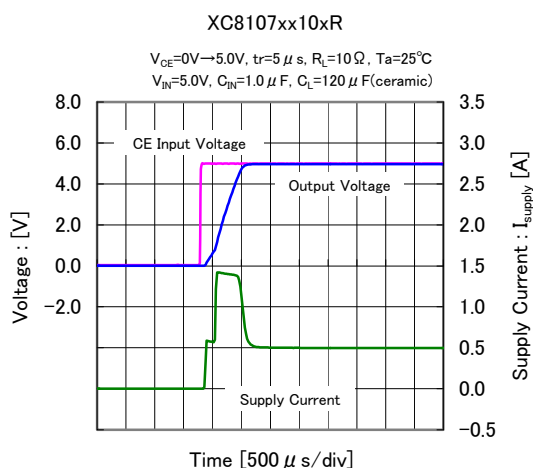

(25) turn-off Delay vs. Fall Time ($C_L=120\ \mu\text{F}$)

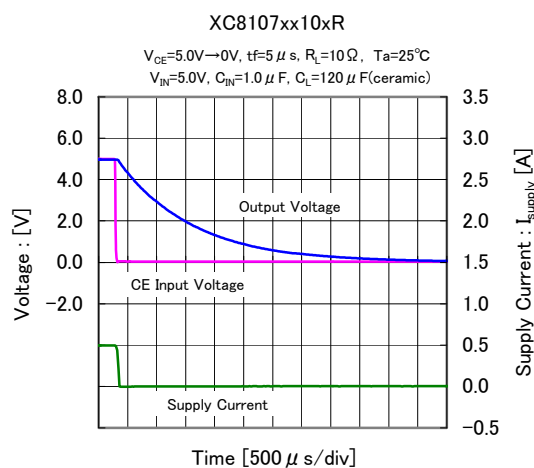

(26) Short Circuit Current, Device Enabled Into Short

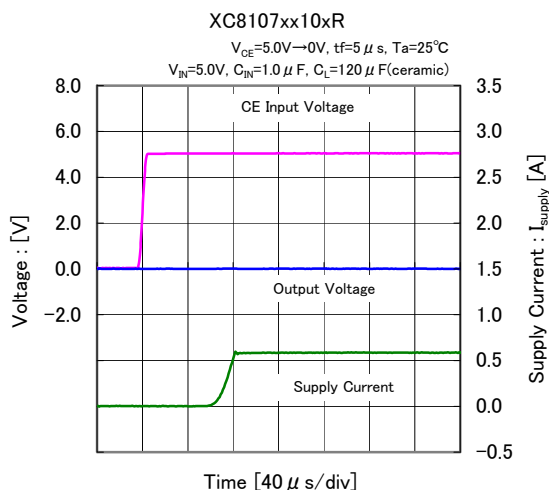
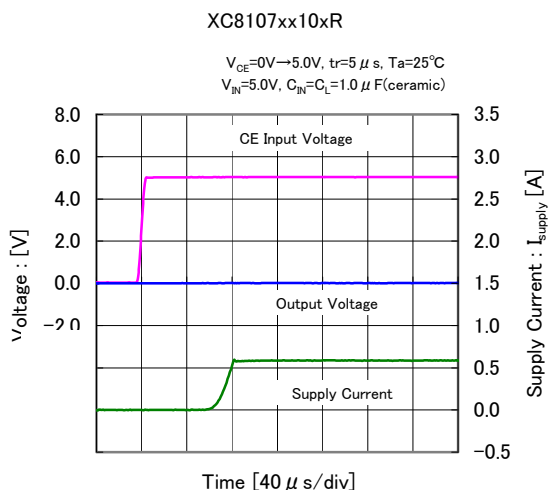

TYPICAL PERFORMANCE CHARACTERISTICS (Continued)

(27) Short-Circuit Transient Response
 ($V_{OUT}=5.0\Omega \rightarrow \text{short}$, $C_L=1.0\mu\text{F}$)

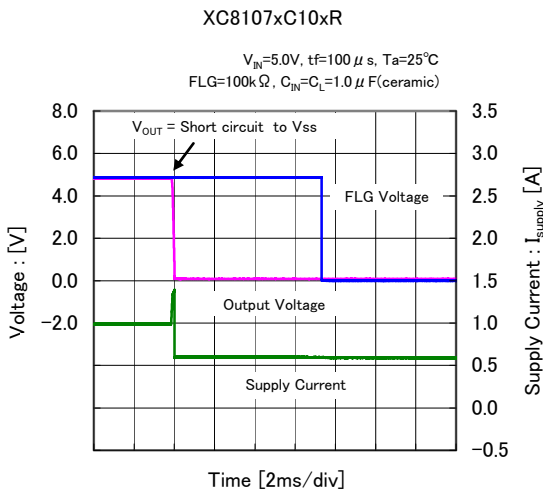

(28) Short-Circuit Transient Response
 ($V_{OUT}=\text{short} \rightarrow 5.0\Omega$, $C_L=1.0\mu\text{F}$)

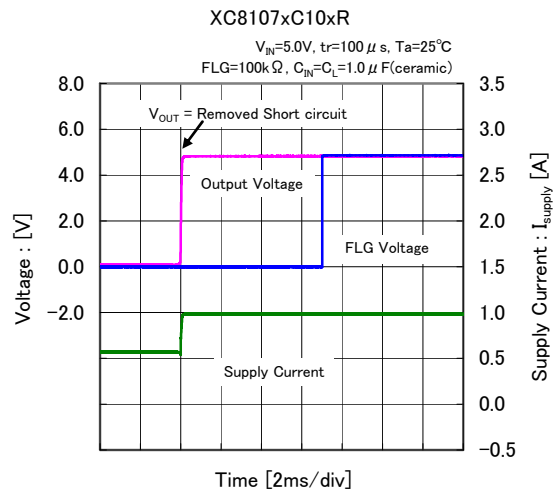

(29) Short-Circuit Transient Response
 ($V_{OUT}=\text{open} \rightarrow \text{short}$, $C_L=1.0\mu\text{F}$)

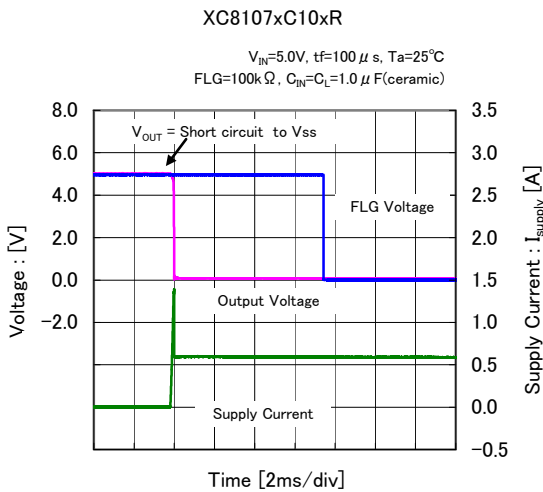

(30) Short-Circuit Transient Response
 ($V_{OUT}=\text{short} \rightarrow \text{open}$, $C_L=1.0\mu\text{F}$)

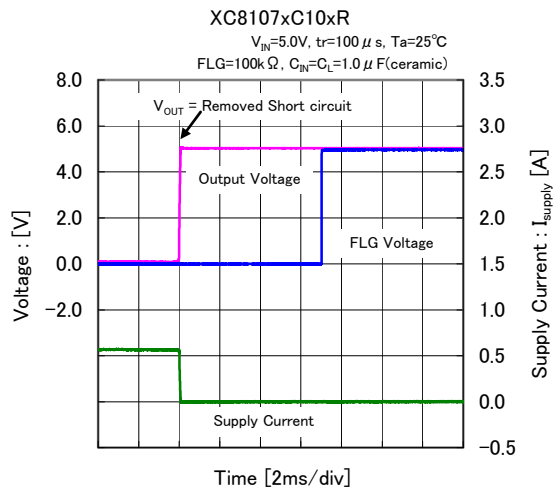

(31) Short-Circuit Transient Response
 ($V_{OUT}=5.0\Omega \rightarrow \text{short}$, $C_L=120\mu\text{F}$)

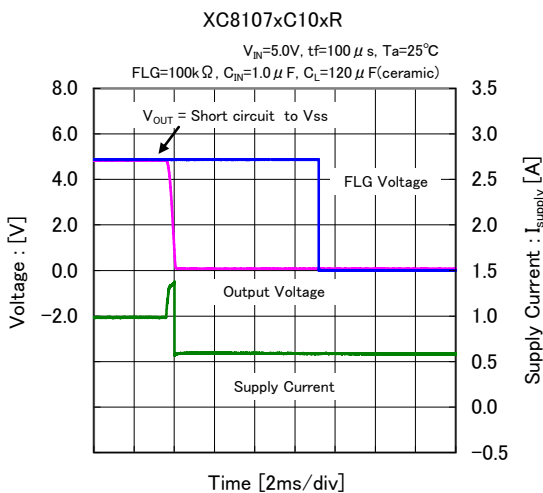

(32) Short-Circuit Transient Response
 ($V_{OUT}=\text{short} \rightarrow 5.0\Omega$, $C_L=120\mu\text{F}$)

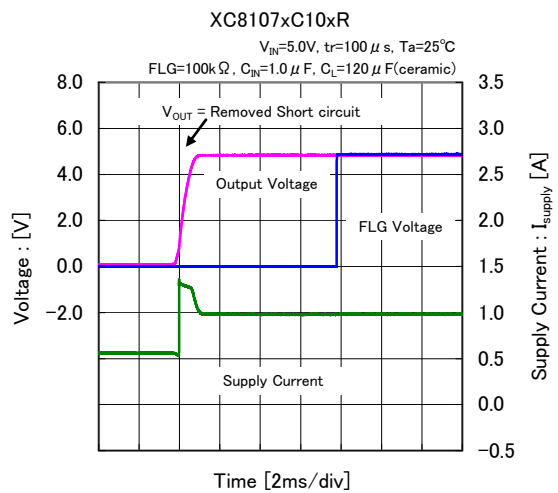

■ TYPICAL PERFORMANCE CHARACTERISTICS (Continued)

(33) Short-Circuit Transient Response
(V_{OUT} =open→short, $C_L=120\ \mu\text{F}$)

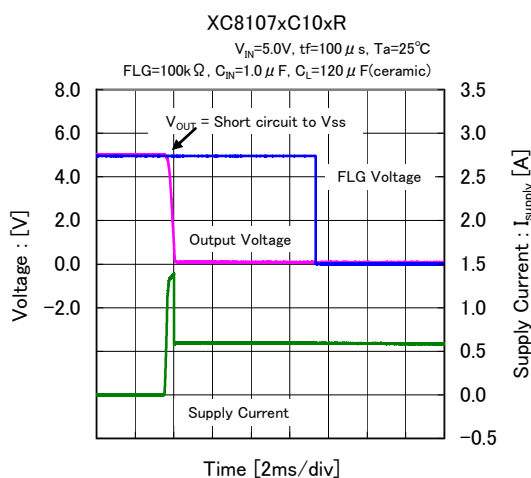

(34) Short-Circuit Transient Response
(V_{OUT} =short→open, $C_L=120\ \mu\text{F}$)

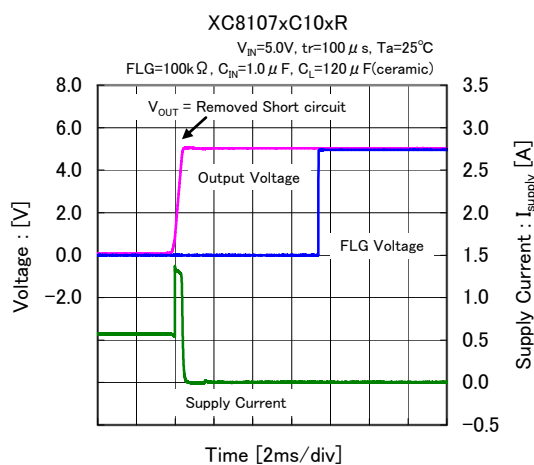

(35) UVLO Transient Response ($C_L=1.0\ \mu\text{F}$)

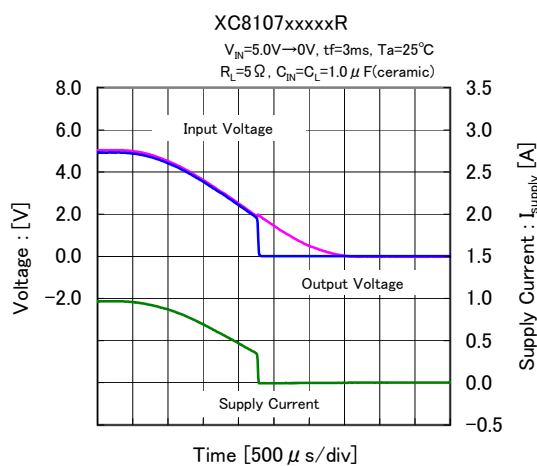
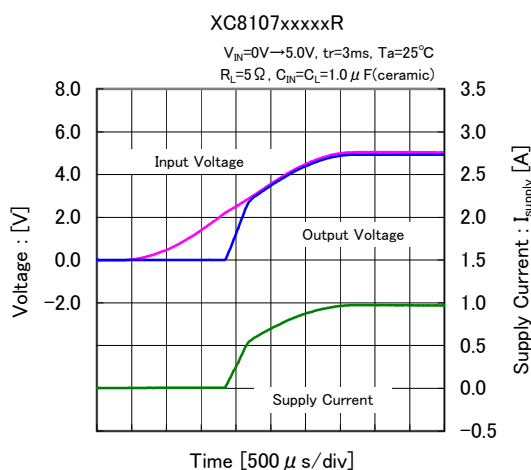

(36) UVLO Transient Response ($C_L=120\ \mu\text{F}$)

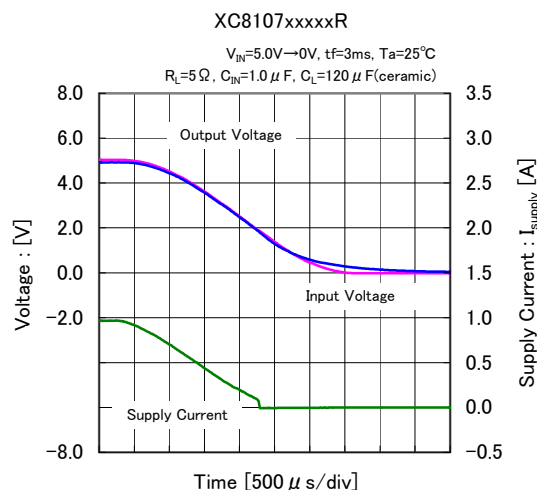
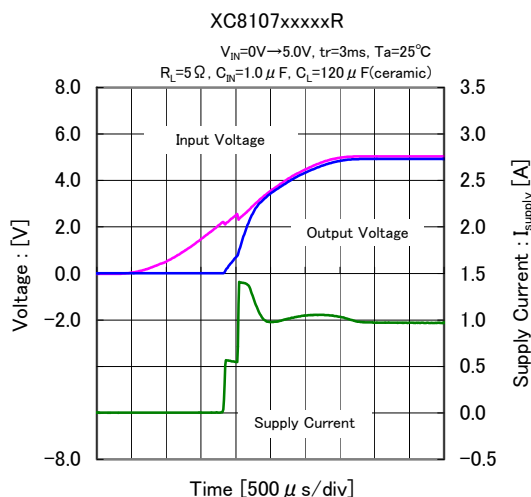

TYPICAL PERFORMANCE CHARACTERISTICS (Continued)

(37) Reverse Voltage Detected Voltage ($C_L=1.0\ \mu\text{F}$)

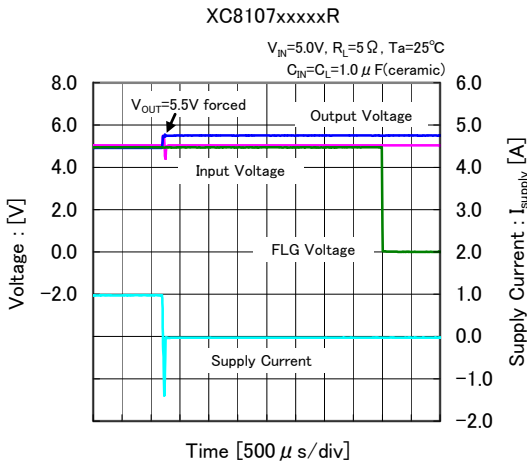

(38) Reverse Voltage Released Voltage ($C_L=1.0\ \mu\text{F}$)

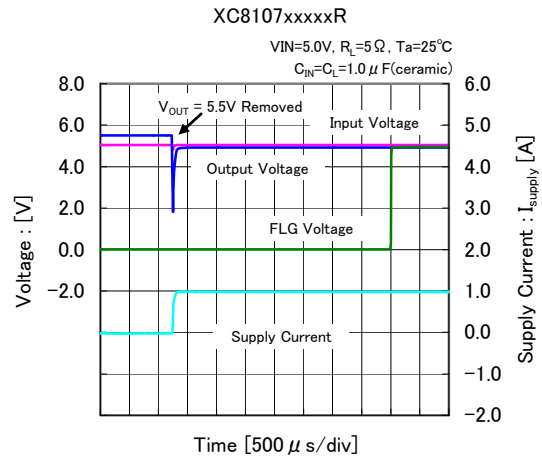

(39) Reverse Voltage Detected Voltage ($C_L=120\ \mu\text{F}$)

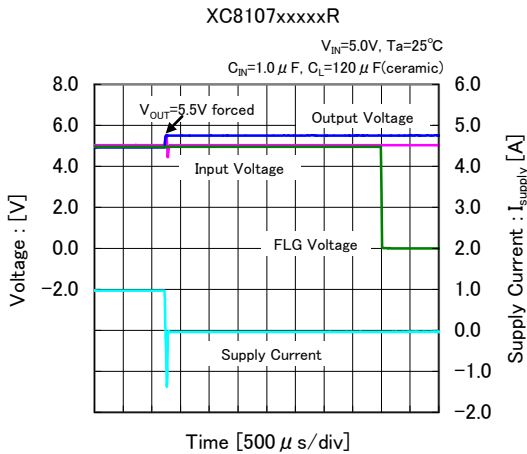

(40) Reverse Voltage Released Voltage ($C_L=120\ \mu\text{F}$)

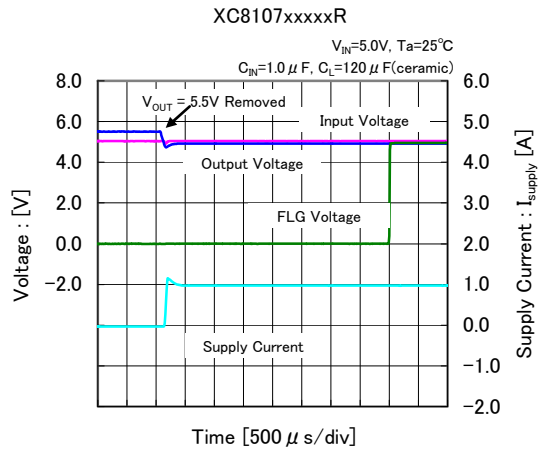

(41) CE Transient Response

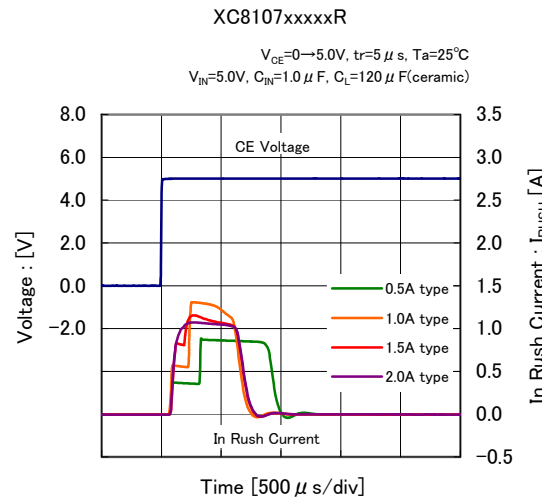
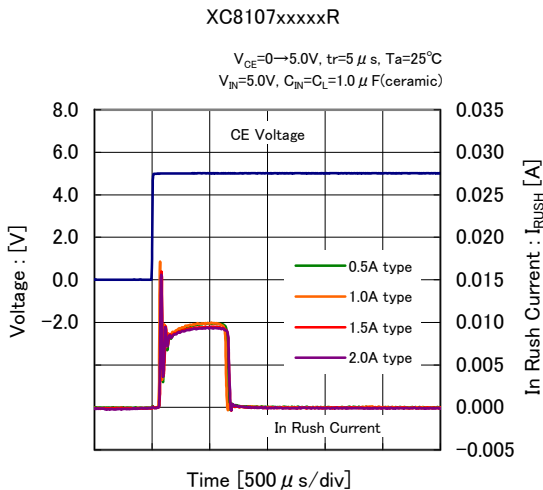

■ TYPICAL PERFORMANCE CHARACTERISTICS (Continued)

(42) Short Applied

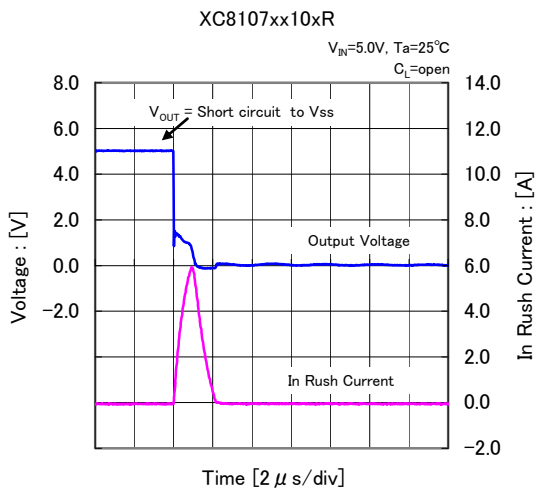

(43) Current Limit adapted time

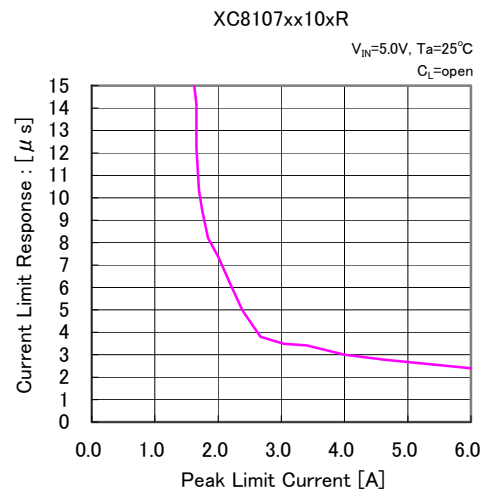

PACKAGING INFORMATION

● USP-6C (unit:mm)

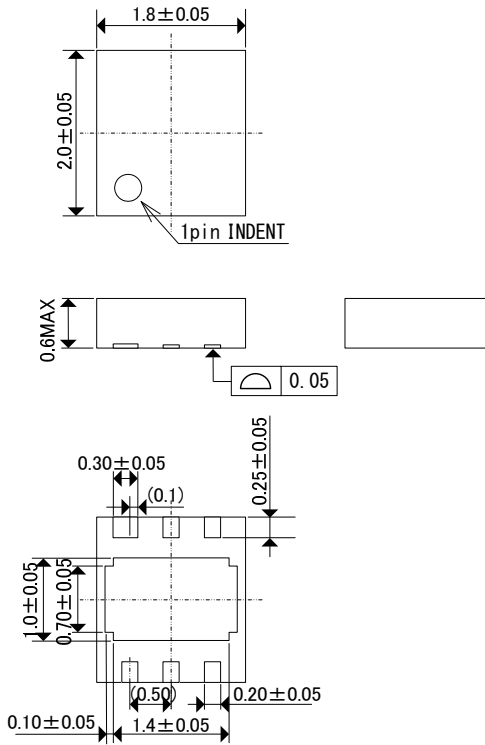

● SOT-25 (unit:mm)

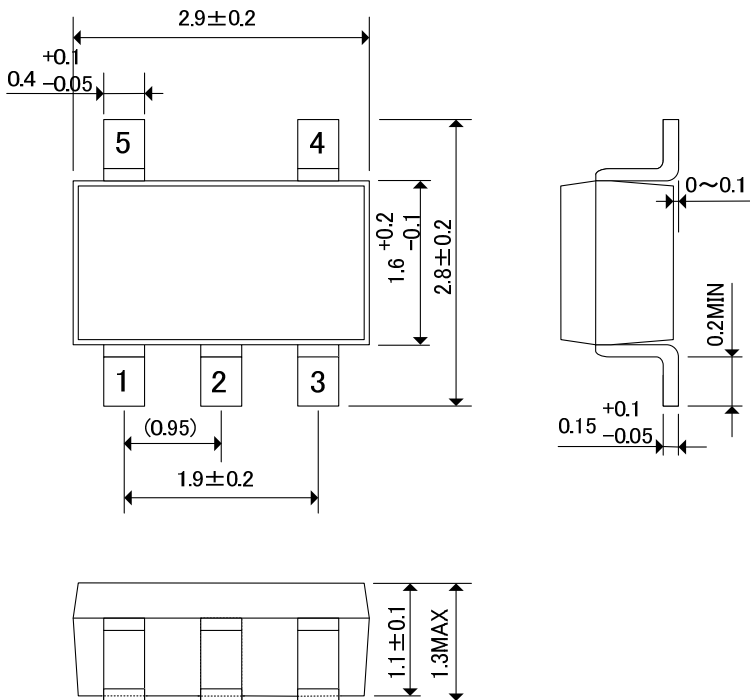

■ **PACKAGING INFORMATION (Continued)**

● USP-6C Reference Pattern Layout (unit: mm)

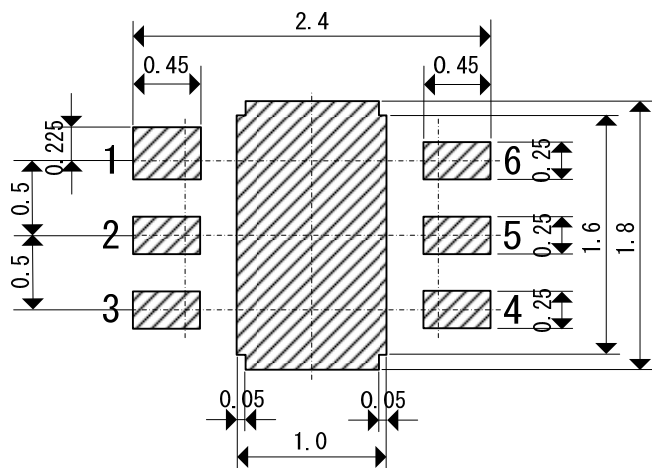

● USP-6C Reference Metal Mask Design (unit: mm)

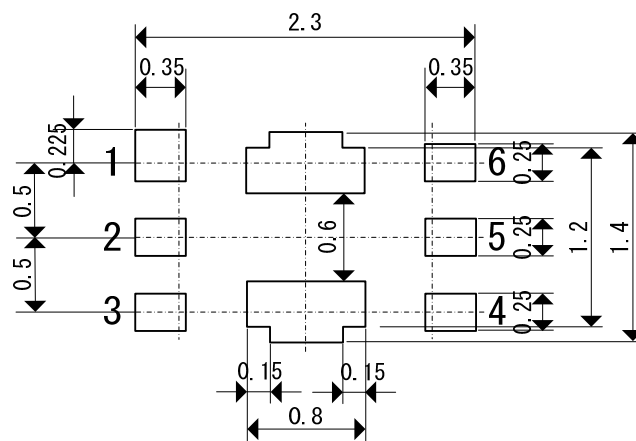

PACKAGING INFORMATION (Continued)

● SOT-25 Power Dissipation

Power dissipation data for the SOT-25 is shown in this page.
The value of power dissipation varies with the mount board conditions.
Please use this data as the reference data taken in the following condition.

1. Measurement Condition

- Condition: Mount on a board
- Ambient: Natural convection
- Soldering: Lead (Pb) free
- Board: Dimensions 40 x 40 mm (1600 mm² in one side)
Copper (Cu) traces occupy 50% of the board area
In top and back faces
Package heat-sink is tied to the copper traces
(Board of SOT-26 is used)
- Material: Glass Epoxy (FR-4)
- Thickness: 1.6mm
- Through-hole 4 x 0.8 Diameter

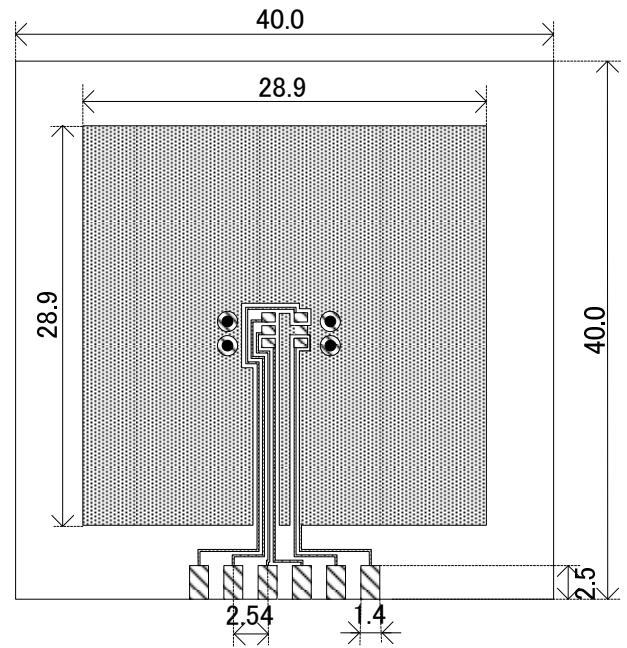

Evaluation Board (Unit: mm)

2. Power Dissipation vs. Ambient Temperature (105°C)

Board Mount (T_{jmax}=125°C)

Ambient Temperature (°C)	Power Dissipation Pd (mW)	Thermal Resistance (°C/W)
25	600	166.67
105	120	

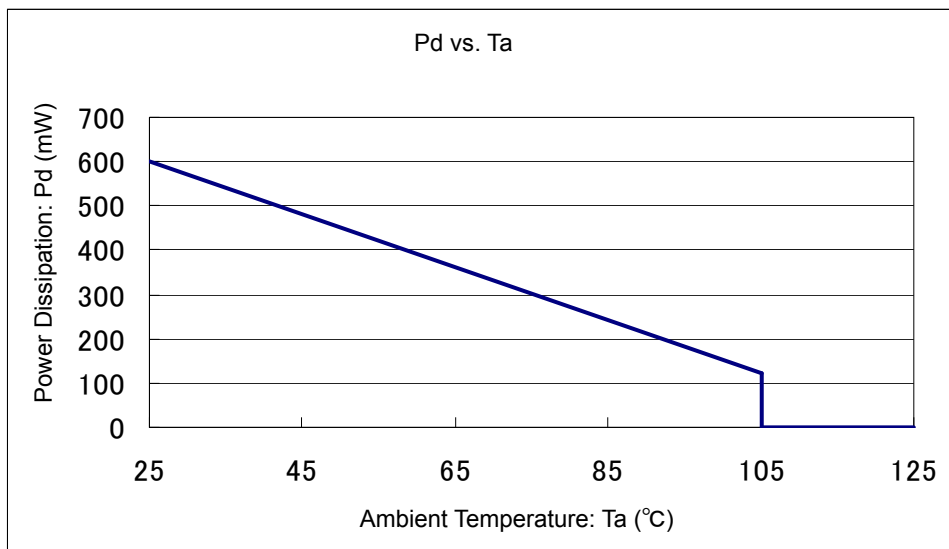

■ PACKAGING INFORMATION (Continued)

● USP-6C Power Dissipation

Power dissipation data for the USP-6C is shown in this page.
The value of power dissipation varies with the mount board conditions.
Please use this data as the reference data taken in the following condition.

1. Measurement Condition

- Condition: Mount on a board
- Ambient: Natural convection
- Soldering: Lead (Pb) free
- Board: Dimensions 40 x 40 mm (1600 mm² in one side)
Copper (Cu) traces occupy 50% of the board area
In top and back faces
Package heat-sink is tied to the copper traces
- Material: Glass Epoxy (FR-4)
- Thickness: 1.6mm
- Through-hole 4 x 0.8 Diameter

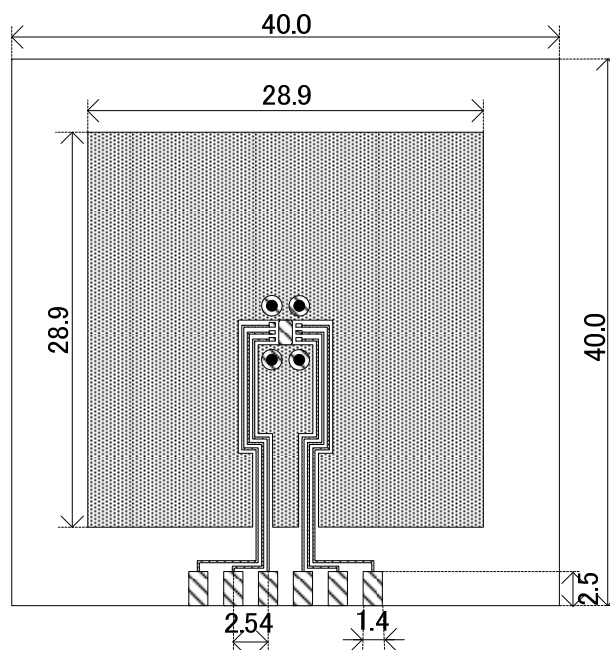

Evaluation Board (Unit: mm)

2. Power Dissipation vs. Ambient Temperature (105°C)

Board Mount (T_{jmax}=125°C)

Ambient Temperature (°C)	Power Dissipation Pd (mW)	Thermal Resistance (°C/W)
25	1000	100.00
105	200	

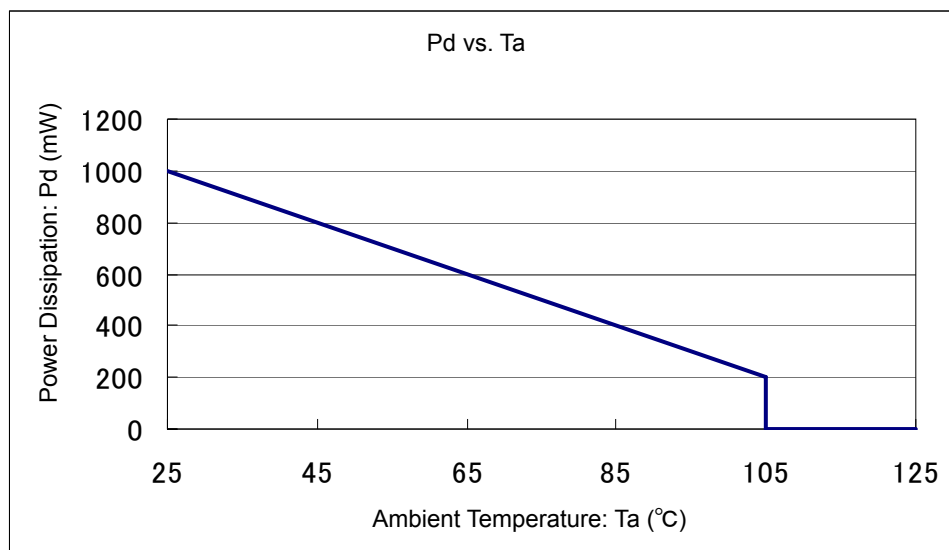

MARKING RULE

SOT-25

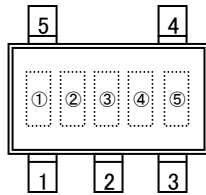

USP-6C

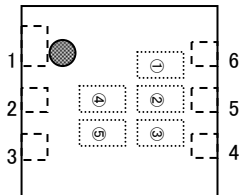

① represents products series

MARK	PRODUCT SERIES
Z	XC8107*****-G

② represents product type

MARK	CE LOGIC	PROTECTION CIRCUIT TYPE	PRODUCT SERIES
1	Active High	Auto-recovery	XC8107AC****-G
2	Active High	Latch-off	XC8107AD****-G
3	Active Low	Auto-recovery	XC8107BC****-G
4	Active Low	Latch-off	XC8107BD****-G

③ represents maximum output current

MARK	CURRENT (A)	PRODUCT SERIES
1	0.5	XC8107**05**-G
2	1.0	XC8107**10**-G
3	1.5	XC8107**15**-G
4	2.0	XC8107**20**-G

④⑤ represents production lot number

01~09, 0A~0Z, 11~9Z, A1~A9, AA~AZ, B1~ZZ in order.

(G, I, J, O, Q, W excluded)

* No character inversion used.

1. The products and product specifications contained herein are subject to change without notice to improve performance characteristics. Consult us, or our representatives before use, to confirm that the information in this datasheet is up to date.
2. We assume no responsibility for any infringement of patents, patent rights, or other rights arising from the use of any information and circuitry in this datasheet.
3. Please ensure suitable shipping controls (including fail-safe designs and aging protection) are in force for equipment employing products listed in this datasheet.
4. The products in this datasheet are not developed, designed, or approved for use with such equipment whose failure or malfunction can be reasonably expected to directly endanger the life of, or cause significant injury to, the user.
(e.g. Atomic energy; aerospace; transport; combustion and associated safety equipment thereof.)
5. Please use the products listed in this datasheet within the specified ranges.
Should you wish to use the products under conditions exceeding the specifications, please consult us or our representatives.
6. We assume no responsibility for damage or loss due to abnormal use.
7. All rights reserved. No part of this datasheet may be copied or reproduced without the prior permission of TOREX SEMICONDUCTOR LTD.

TOREX SEMICONDUCTOR LTD.

Компания «Life Electronics» занимается поставками электронных компонентов импортного и отечественного производства от производителей и со складов крупных дистрибьюторов Европы, Америки и Азии.

С конца 2013 года компания активно расширяет линейку поставок компонентов по направлению коаксиальный кабель, кварцевые генераторы и конденсаторы (керамические, пленочные, электролитические), за счёт заключения дистрибьюторских договоров

Мы предлагаем:

- Конкуренспособные цены и скидки постоянным клиентам.
- Специальные условия для постоянных клиентов.
- Подбор аналогов.
- Поставку компонентов в любых объемах, удовлетворяющих вашим потребностям.
- Приемлемые сроки поставки, возможна ускоренная поставка.
- Доставку товара в любую точку России и стран СНГ.
- Комплексную поставку.
- Работу по проектам и поставку образцов.
- Формирование склада под заказчика.
- Сертификаты соответствия на поставляемую продукцию (по желанию клиента).
- Тестирование поставляемой продукции.
- Поставку компонентов, требующих военную и космическую приемку.
- Входной контроль качества.
- Наличие сертификата ISO.

В составе нашей компании организован Конструкторский отдел, призванный помогать разработчикам, и инженерам.

Конструкторский отдел помогает осуществить:

- Регистрацию проекта у производителя компонентов.
- Техническую поддержку проекта.
- Защиту от снятия компонента с производства.
- Оценку стоимости проекта по компонентам.
- Изготовление тестовой платы монтаж и пусконаладочные работы.



Тел: +7 (812) 336 43 04 (многоканальный)

Email: org@lifeelectronics.ru