

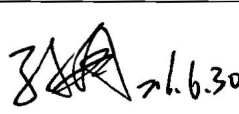

Product Specification

Product Name: T101UB01D02

Customer
Approved by Customer
Approved Date:

Designed By	Checked by	Approved By	
		R&D	QA
 6.6.30	 2016.6.30	 6.30	 6/30/16

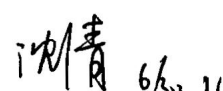
CONTENT

REVISION RECORD	3
1 OVERVIEW	4
2 FEATURES	4
3 GENERAL INFORMATION	4
4 MECHANICAL DRAWING	5
5 MODULE INTERFACE	6
5.1 TFT PIN DESCRIPTION.....	6
5.2 BACK-LIGHT UNIT.....	7
6 ABSOLUTE MAXIMUM RATING	8
6.1 ELECTRICAL ABSOLUTE RATING.....	8
7 ELECTRICAL CHARACTERISTICS	9
7.1 DC ELECTRICAL CHARACTERISTICS.....	9
7.2 AC ELECTRICAL CHARACTERISTICS.....	10
8 POWER ON/OFF SEQUENCE	11
9 OPTICAL CHARACTERISTICS	12
10 PACKAGE SPECIFICATION	15
11 RELIABILITY	16
12 ILLUSTRATION OF PRODUCT NAME	17
13 PRECAUTIONS FOR OPERATION AND STORAGE	17
13.1 PRECAUTIONS FOR OPERATION.....	18
13.2 SOLDERING.....	18
13.3 PRECAUTIONS FOR STORAGE.....	18
13.4 WARRANTY PERIOD.....	18

1 Overview

The specifications is a transmissive type color active matrix liquid crystal display (LCD) which uses amorphous thin film transistor (TFT) as switching devices. This product is composed of a TFT LCD panel, driver IC, FPC, and a backlight unit.

2 Features

- Panel Size: 10.1 inch
- Number of Pixels /Resolution: 1024×RGB×600
- Interface: LVDS
- RoHS and Halogen-Free Compliance
- Applications: Multimedia application and other hand application

3 General Information

NO.	ITEM	SPECIFICATION	UNIT
1	Dot Matrix	1024(W)×600(H)	Pixels
2	Dot Pitch	0.2175(W)×0.2088 (H)	mm
3	Active Area	222.72(W)×125.28(H)	mm
4	Module Size	235(W)×143(H)×7.54(T)	mm
5	Viewing Angle	6 O'clock	mm
6	Module Weight	TBD	gram

4 Mechanical Drawing

Front side

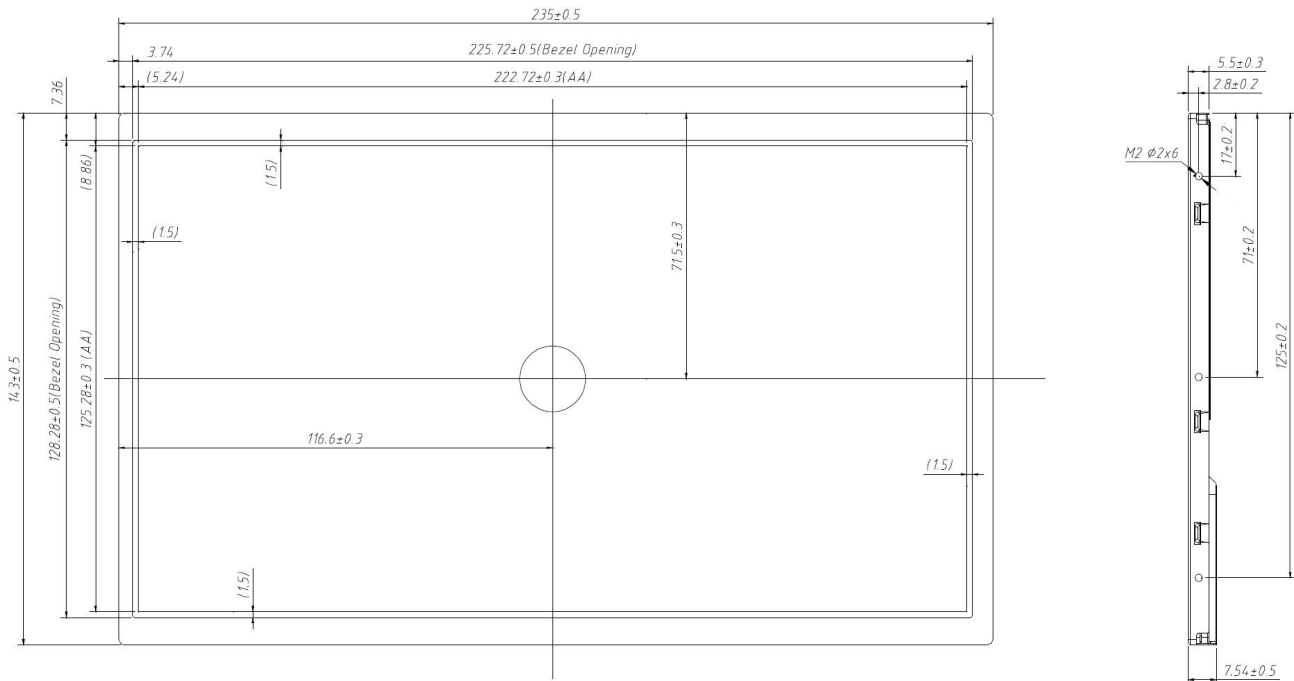

Back side

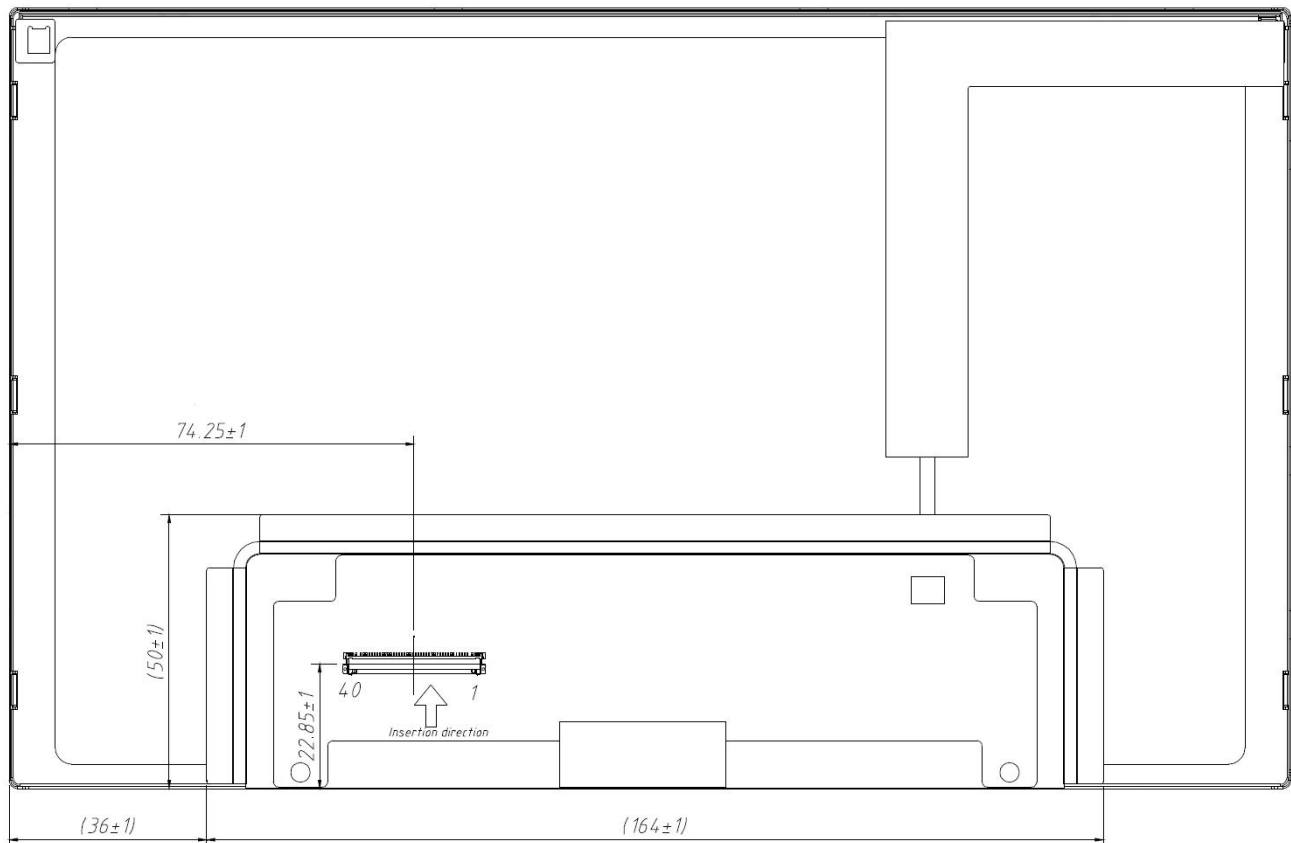

5 Module Interface

5.1 TFT PIN Description

Item		Description	
Connector		MSAK24025P40D	
Pin #	Signal Name	Description	Remarks
1	BIST	BIST MODE SELECT(High Enable)	FOR INTERNAL TEST
2	VDD	LCD power supply (Typ. +3.3V)	
3	VDD	LCD power supply (Typ. +3.3V)	
4	V_EDID	EDID power supply	
5	NC	No connection	
6	CLK_EDID	EDID CLK signal	
7	Data_EDID	EDID Data signal	
8	LVDS input 0-	LVDS CH0 data signal(-) 、 R0~R5 、 G0	
9	LVDS input 0+	LVDS CH0 data signal(+) 、 R0~R5 、 G0	
10	GND	GND	
11	LVDS input 1-	LVDS CH1 data signal(-) 、 G1~G5 、 B0 、 B1	
12	LVDS input 1+	LVDS CH1 data signal(+) 、 G1~G5 、 B0 、 B1	
13	GND	GND	
14	LVDS input 2-	LVDS CH2 data signal(-) 、 B2~B5 、 DE	
15	LVDS input 2+	LVDS CH0 data signal(+) 、 B2~B5 、 DE	
16	GND	GND	
17	LVDS CLK -	LVDS CLK data signal(-)	
18	LVDS CLK +	LVDS CLK data signal(+)	
19	GND	GND	
20	LVDS input 3-	LVDS CH3 data signal(-) 、 R6~R7 、 G6~G7 、 B6~B7	
21	LVDS input 3+	LVDS CH3 data signal(+) 、 R6~R7 、 G6~G7 、 B6~B7	
22	GND	GND	
23	NC	No connection	
24	NC	No connection	
25	GND	GND	
26	NC	No connection	
27	NC	No connection	
28	GND	GND	
29	NC	No connection	
30	NC	No connection	
31	GND	GND	

32	GND	GND	
33	GND	GND	
34	NC	No connection	
35	PWM	LED dimming signal	
36	LED_EN	LED Enable signal	
37	NC	No connection	
38	VLED	LED power supply (Typ. 5V)	
39	VLED	LED power supply (Typ. 5V)	
40	VLED	LED power supply (Typ. 5V)	

5.2 Back-Light Unit

ITEM	UNIT	MIN	TYP	MAX	CONDITION
VIN_LED	V	4.5	5	5.5	DUTY=100%
I _{VIN_LED}	mA	-	-	586	V_LED=4.5V , η=85%
F _{DIM}	Hz	200	-	1K	-
DUTY	%	5	-	100	-
EN/PWM	VIH	V	2	5	-
	VIL	V	0	0.5	-
V _{out}	V	11.6	13.2	14	-
I _{OUT}	mA	-	159	-	-
L _T	Hours	(30,000)	-	-	LED Life Time

Note: The LED life time define as the estimated time to 50% degradation of initial luminous.

6 Absolute Maximum Rating

6.1 Electrical Absolute Rating

ITEM	SYMBOL	MIN.	MAX.	UNIT	REMARK
Supply Voltage	V_{IN}	-0.3	3.96	V	Logic power supply voltage
		-0.3	12	V	LED Driver Vin
Power Supply Fuse Current Setting	I_{FUSE}	-	1.5	A	Vin from 10% ~ 90% , rise time 500us
Input Signal	V_S	-	3.6	V	LVDS signals
EN/PWM Voltage	V_{PWM}	-0.3	12	V	EN/PWM Voltage

Absolute Ratings of Environment

Item	Symbol	Min.	Max.	Unit	Conditions
Operating Temperature	TOP	-20	70	°C	(1),(2)
Operating Humidity	HOP	10	85	%RH	
Storage Temperature	TST	-30	80	°C	
Storage Humidity	HST	10	95	%RH	

Note (1) There is no display function fail occurred, all the cosmetic specification is judged before the reliability stress. The criteria is fit by IVO provided IIS.

(2) The storage /operating temperature. Maximum Wet-Bulb should be 39 degree C. There is no condensation on the panel surface.

7 Electrical Characteristics

7.1 DC Electrical Characteristics

ITEM	SYMBOL	MIN.	TYP.	MAX.	UNIT	CONDITIONS
System Power Supply						
Input Power Supply Voltage	V_{IN}	3.0	3.3	3.6	V	
Input Power Supply Current	I_{VIN}	-	-	217	mA	Black pattern · 60Hz
Input Inrush Current	I_{RUSH}	-	-	1.5	A	0.5ms rise time (10%~90%)
Input Power Voltage Ripple	V_{RPL}	-	-	200	mV	Vp-p
LED Power Supply						
Input Power Supply Voltage	V_{LED-IN}	4.5	5	5.5	V	
Input Power Supply Current	I_{IN}	-	-	586	mA	$V_{LED}=4.5V, \eta=85\%$
EN/PWM	VH	2.0	-	5.0	V	
	VL	0	-	0.5	V	
LVDS Signals						
Differential Input High Threshold	V_{th}	-	-	+100	mV	$V_{cm}=+1.2V$
Differential Input Low Threshold	V	-100	-	-	mV	$V_{cm}=+1.2V$
Magnitude Differential Input Voltage	$ V_{id} $	200	-	600	mV	
Common Mode Voltage	V_{cm}	1.0	1.2	1.4	V	$V_{th} - V_{tl} = 200mV$
Common Mode Voltage Offset	ΔV_{cm}	-50	-	+50	mV	$V_{th} - V_{tl} = 200mV$
EDID Power Supply						
Input Power Supply Voltage	V_{EDID}	3.0		3.6	V	

Note: A. Input signals shall be low or Hi-Z state when VIN is off.

B. All electrical characteristics for LVDS signal are defined and shall be measured at the interface connector of LCD.

C. White Pattern at 3.3V driving voltage.

7.2 AC Electrical Characteristics

7.2.1 Timing Characteristics

Interface Timings

Synchronization Method: DE only

Parameter	Symbol	Unit	Min.	Typ.	Max.
LVDS Clock Frequency <single>	f_{dck}	MHz	45	51.2	65
H Total Time	T_{hp}	clocks	1,324	1,344	1,364
H Active Time	HA	clocks	1,024	1,024	1,024
H Blanking Time	T_{HBLANK}	clocks	300	320	340
V Total Time	T_{vp}	lines	615	635	645
V Active Time	VA	lines	600	600	600
V Blanking Time	T_{VBLANK}	lines	15	35	45
V Frequency	f_v	Hz	55	60	65

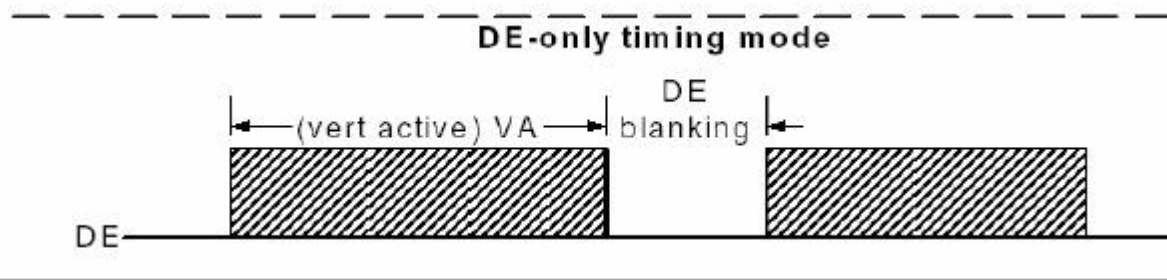

7.2.2 Timing Diagram of Interface Signal

LVDS Data Mapping

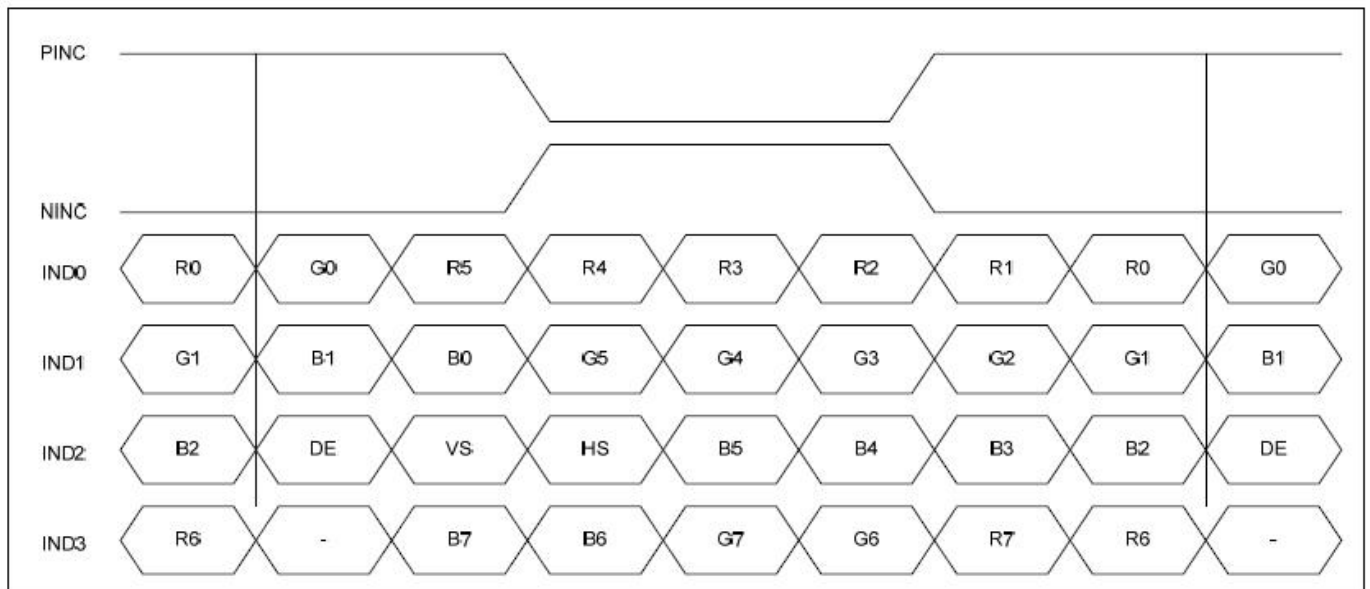

8 Power ON/OFF Sequence

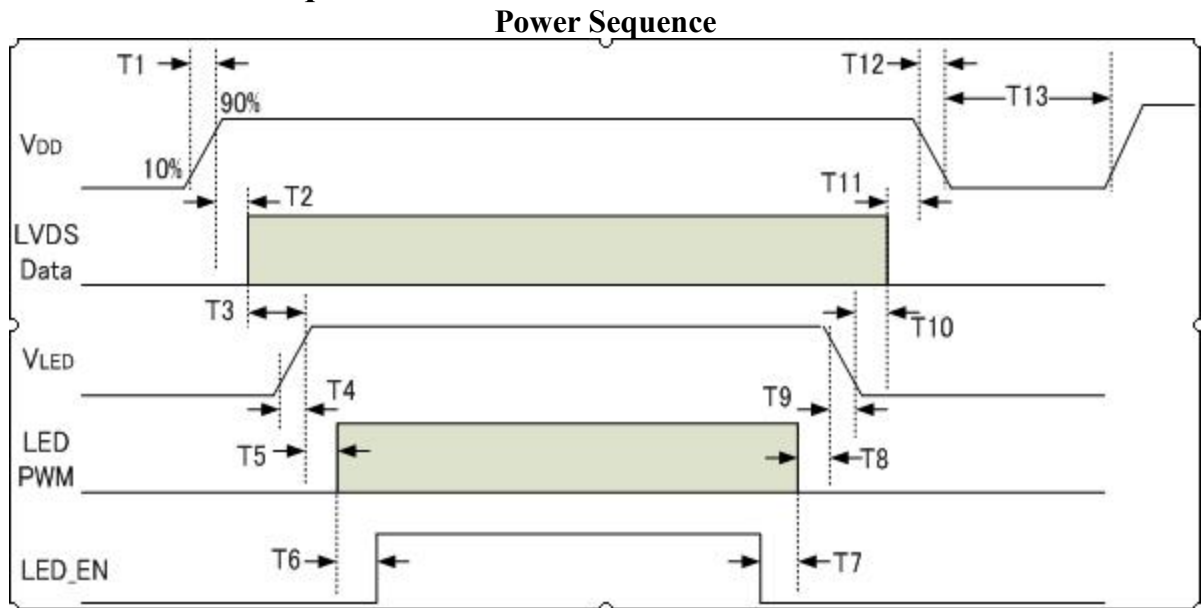

Power Sequencing Requirements

Parameter	Symbol	Unit	min	Typ.	max
VDD rising Time	T1	ms	0.5	--	10
VDD Good to Signal Valid	T2	ms	30	--	90
Signal Valid to Backlight on	T3	ms	200	--	--
Backlight Power on time	T4	ms	0.5	--	--
Backlight VDD Good to System PWM on	T5	ms	10	--	--
System PWM on to Backlight Enable on	T6	ms	10	--	--
Backlight Enable off to System PWM off	T7	ms	0	--	--
System PWM off to B/L Power Disable	T8	ms	10	--	--
Backlight Power off time	T9	ms	1	10	30
Backlight off to signal Disable	T10	ms	200	--	--
Signal Disable to Power Down	T11	ms	0	--	50
VDD Falling Time	T12	ms	1	10	30
Power Off	T13	ms	500	--	--

9 Optical characteristics

Item	Conditions		Min.	Typ.	Max.	Unit	Note		
Viewing Angle (CR>10)	Horizontal	θ_L	(70)	(80)	-	degree	(1),(2), (3)		
		θ_R	(70)	(80)	-				
	Vertical	θ_T	(70)	(80)	-				
		θ_B	(70)	(80)	-				
Contrast Ratio	Center		-	500	-	-	(1),(2), (4)		
Response Time	Rising		-	TBD	-	ms	(1),(2),(5)		
	Falling		-	TBD	-	ms			
	Rising + Falling		-	16	-	ms			
Chromaticity (CIE1931)	NTSC		-	45	-	%	(1),(2)		
	Red	x	Typ. -0.03	TBD	Typ. -0.03	-			
	Red	y		TBD		-			
	Green	x		TBD		-			
	Green	y		TBD		-			
	Blue	x		TBD		-			
	Blue	y		TBD		-			
	White	x		0.255		0.305		0.355	-
	White	y		0.275		0.325		0.375	-
White Luminance	Center		-	350	-	cd/m ²	(1),(2),(6)		
Luminance Uniformity	9Points		75	80	-	%	(1),(2),(6)		

Note (1) Measurement Setup:

The LCD module should be stabilized at given temperature(25°C) for 15 minutes to Avoid abrupt temperature change during measuring. In order to stabilize the luminance, the measurement should be executed after lighting backlight for 15 minutes in a windless room.

Measurement Setup

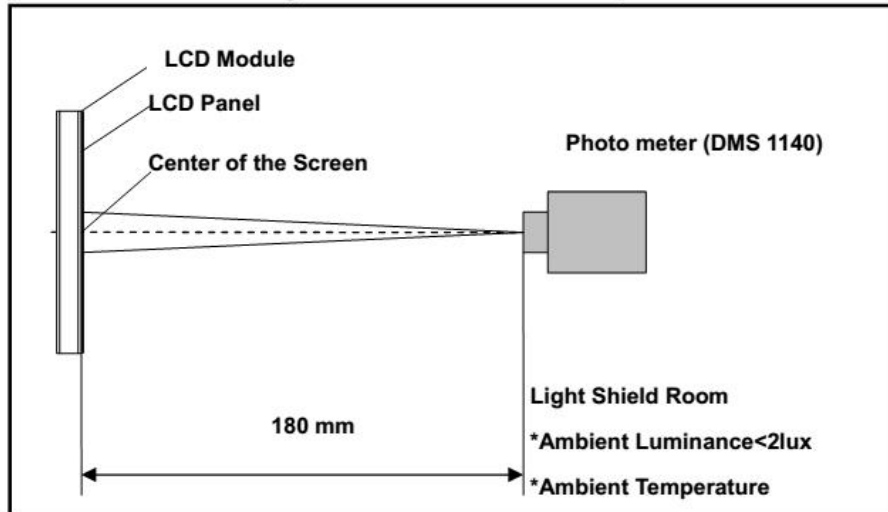

Note (2) The LED input parameter setting as:

VLED: 5V;

PWM_LED: Duty 100 %

Note (3) Definition of Viewing Angle

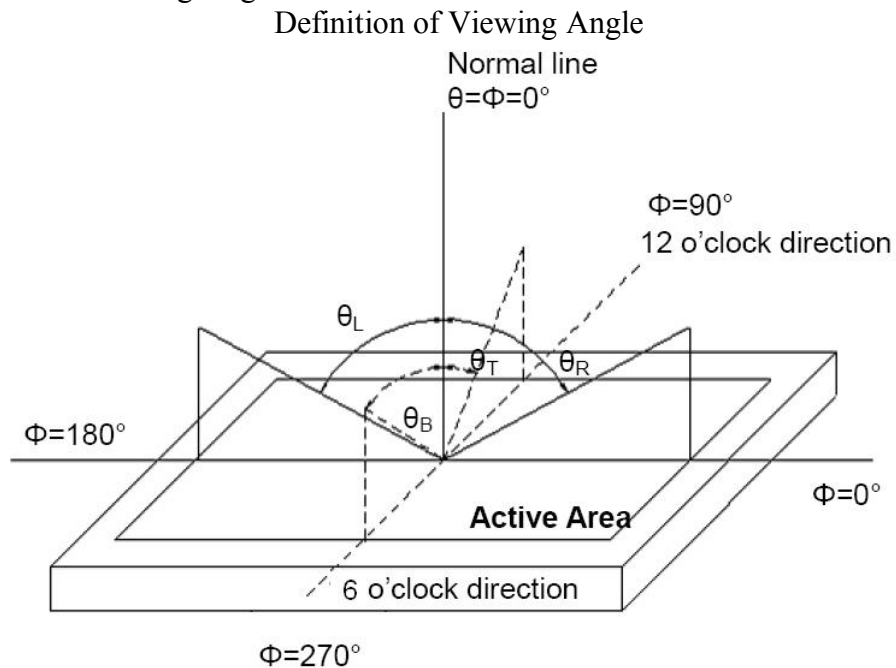

Note (4) Definition Of Contrast Ratio (CR)

The contrast ratio can be calculated by the following expression

$$\text{Contrast Ratio (CR)} = L_{255} / L_0$$

L255: Luminance of gray level 255, L0: Luminance of gray level 0

Note (5) Definition Of Response Time (TR, TF)

Definition of Response Time

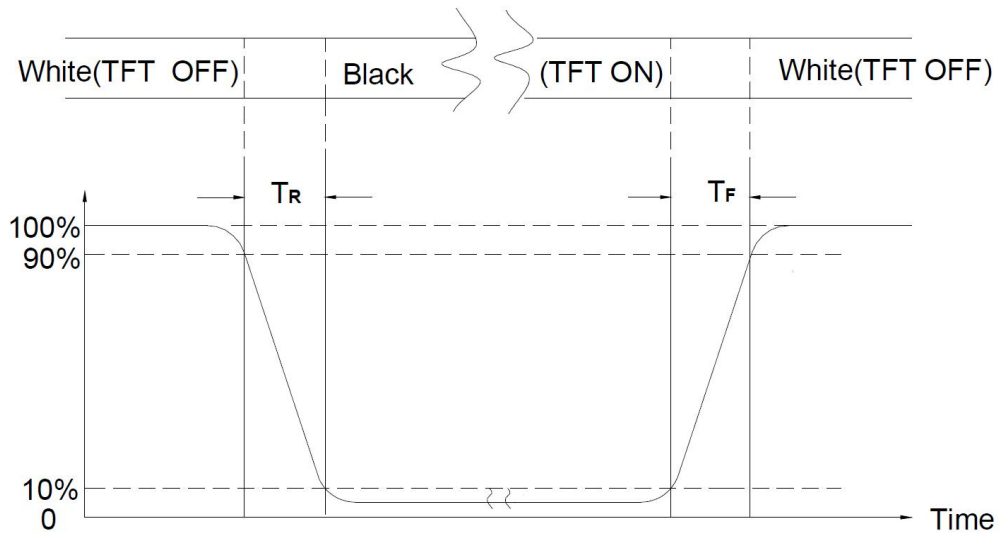

Note (6) Definition Of Brightness Luminance

$$\text{Luminance Uniformity} = \frac{(\text{Min Luminance of 9 points})}{(\text{Max Luminance of 9 points})} \times 100\%$$

Measurement Locations

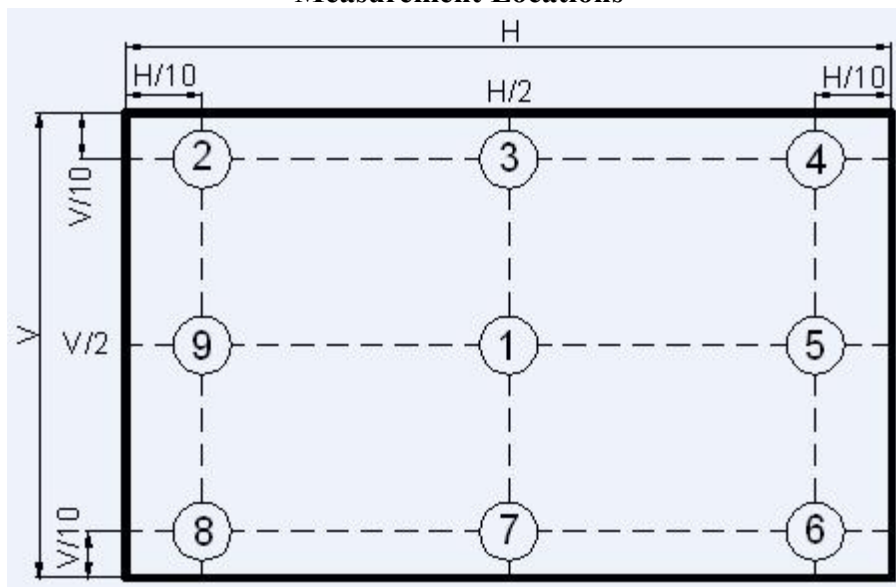

10 Package Specification

TBD

11 Reliability

Items	Required Condition	Note
High Temperature Operating Test	70°C, 300hrs	
Low Temperature Operating Test	-20°C, 300hrs	
High Temperature Storage Test	80°C, 300hrs	
Low Temperature Storage Test	-30°C, 300hrs	
High Temperature/High Humidity Operation Test	50°C, 85%, 300hrs	
Thermal Shock Test	-20°C~60°C, 1h/each cycle,100cycles	
Shock Test (Non-Operating)	50G,20ms,Half Sine Wave, (±X, ±Y,±Z)	
Vibration Test (Non-Operating)	1.5G ,10~200 Hz, x、 y、 z each axis/30min	
ESD test	Contact Discharge: ±8KV,150pF(330 Ω) ; Air Discharge: ±15KV,150pF(330 Ω)	1

Note1: ESD class C: Performance could be recovered by reset if temporary failure happened.

12 Illustration of Product Name

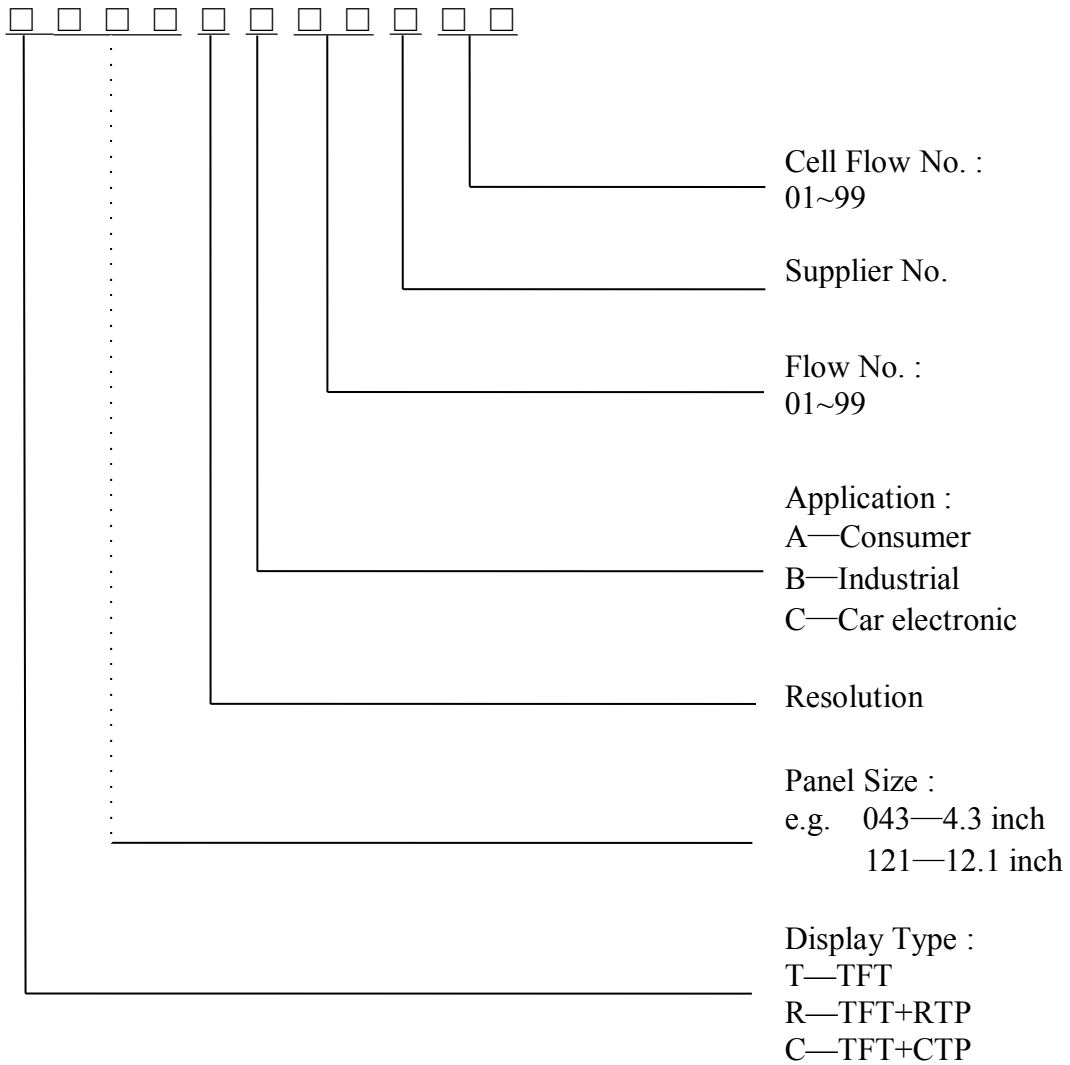

13 Precautions for operation and Storage

13.1 Precautions for Operation

- (1) Since the display panel is made of glass, do not apply any mechanical shock or impact or excessive force to it when installing the module. Any strong mechanical impact due to falling dropping etc. may cause damage (breakage or cracking).
- (2) If the display panel is damaged and the liquid crystal substance inside it leaks out, be sure not to get any in your mouth, if the substance comes into contact with your skin or clothes, promptly wash it off using soap and water.
- (3) The polarizer on the display surface is made of soft material and is easily scratched. Please take most care when handing. When the display surface is contaminated, please wipe it off gently by using moisten soft cloth with isopropyl alcohol, do not use water, ketone or aromatics. If still not completely clear, moisten cloth with isopropyl alcohol or ethyl alcohol solvents.
- (4) When handling the LCD module, please be sure that the body and the tools are properly grounded. And do not touch I/O pins with bare hands or contaminate I/O pins, it will cause disconnection or defective insulation of terminals.
- (5) Do not attempt to disassemble or process the LCD module.
- (6) The LCD Module is coated with a film to protect the display surface. Be care when peeling off this protective film since static electricity may be generated. To reduce the amount of static electricity generated, do not conduct assembly and other work under dry conditions.
- (7) Do not put one product on the other .Otherwise, it may cause the product to bescratched and/or change on cosmetic occur (ex. Newton ring).

13.2 Soldering

- (1) Soldering should be performed only on the I/O terminals.
- (2) Use soldering irons with proper grounding and no leakage.
- (3) Iron: no higher than 300°C and 3~4 sec during soldering.

13.3 Precautions for Storage

- (1) Please store LCD module in a dark place. Avoid exposure to sunlight, the light of fluorescent lamp or any ultraviolet ray.
- (2) Keep the environment temperature between 0°C and 40°C and the relative humidity less than 80%.Avoid high temperature and high humidity.
- (3) Keep the LCD modules stored in the room without acid ,alkali and harmful gas.

13.4 Warranty period

Visionox warrants for a period of 12 months from the shipping date when stored or used under normal condition.

Компания «Life Electronics» занимается поставками электронных компонентов импортного и отечественного производства от производителей и со складов крупных дистрибьюторов Европы, Америки и Азии.

С конца 2013 года компания активно расширяет линейку поставок компонентов по направлению коаксиальный кабель, кварцевые генераторы и конденсаторы (керамические, пленочные, электролитические), за счёт заключения дистрибьюторских договоров

Мы предлагаем:

- Конкурентоспособные цены и скидки постоянным клиентам.
- Специальные условия для постоянных клиентов.
- Подбор аналогов.
- Поставку компонентов в любых объемах, удовлетворяющих вашим потребностям.
- Приемлемые сроки поставки, возможна ускоренная поставка.
- Доставку товара в любую точку России и стран СНГ.
- Комплексную поставку.
- Работу по проектам и поставку образцов.
- Формирование склада под заказчика.
- Сертификаты соответствия на поставляемую продукцию (по желанию клиента).
- Тестирование поставляемой продукции.
- Поставку компонентов, требующих военную и космическую приемку.
- Входной контроль качества.
- Наличие сертификата ISO.

В составе нашей компании организован Конструкторский отдел, призванный помогать разработчикам, и инженерам.

Конструкторский отдел помогает осуществить:

- Регистрацию проекта у производителя компонентов.
- Техническую поддержку проекта.
- Защиту от снятия компонента с производства.
- Оценку стоимости проекта по компонентам.
- Изготовление тестовой платы монтаж и пусконаладочные работы.



Тел: +7 (812) 336 43 04 (многоканальный)

Email: org@lifeelectronics.ru