

Pin Definition:

1. Gate
2. Drain
3. Source

Key Parameter Performance

Parameter	Value	Unit
V_{DS}	250	V
$R_{DS(on)}(max)$	0.6	Ω
Q_g	8.4	nC

Features

- 100% avalanche tested
- Improved ESD performance

Ordering Information

Part No.	Package	Packing
TSM600N25ECH C5G	TO-251	75pcs / Tube
TSM600N25ECP ROG	TO-252	2.5kpcs / 13" Reel

Note: "G" denotes for Halogen- and Antimony-free as those which contain <900ppm bromine, <900ppm chlorine (<1500ppm total Br + Cl) and <1000ppm antimony compounds

Block Diagram

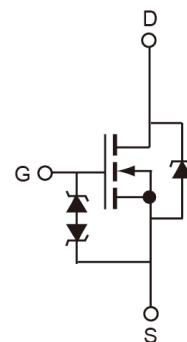

N-Channel MOSFET

Absolute Maximum Ratings

Parameter	Symbol	Limit	Unit	
Drain-Source Voltage	V_{DS}	250	V	
Gate-Source Voltage	V_{GS}	± 30	V	
Continuous Drain Current	I_D	$T_c = 25^\circ C$	8	A
		$T_c = 100^\circ C$	3.6	A
Pulsed Drain Current ^(Note 1)	I_{DM}	32	A	
Single Pulse Avalanche Energy ^(Note 2)	E_{AS}	147	mJ	
Repetitive Avalanche Current ^(Note 1)	I_{AR}	8	A	
Repetitive Avalanche Energy ^(Note 1)	E_{AR}	5.2	mJ	
Power Dissipation @ $T_c = 25^\circ C$	P_D	52	W	
Peak Diode Recovery ^(Note 3)	dv/dt	4.5	V/ns	
Operating Junction Temperature	T_J	150	$^\circ C$	
Storage Temperature Range	T_{STG}	-55 to +150	$^\circ C$	

Thermal Performance

Parameter	Symbol	Limit	Unit
Thermal Resistance - Junction to Case	$R_{\theta JC}$	2.4	$^\circ C/W$
Thermal Resistance - Junction to Ambient	$R_{\theta JA}$	110	

Electrical Specifications (T_c=25°C unless otherwise noted)

Parameter	Conditions	Symbol	Min	Typ	Max	Unit
Static						
Drain-Source Breakdown Voltage	V _{GS} = 0V, I _D = 250μA	BV _{DSS}	250	--	--	V
Drain-Source On-State Resistance	V _{GS} = 10V, I _D = 4A	R _{DS(ON)}	--	0.5	0.6	Ω
Gate Threshold Voltage	V _{DS} = V _{GS} , I _D = 250μA	V _{GS(TH)}	3	--	5	V
Zero Gate Voltage Drain Current	V _{DS} = 250V, V _{GS} = 0V	I _{DSS}	--	--	1	μA
	V _{DS} = 200V, T _c = 125°C		--	--	10	
Gate Body Leakage	V _{GS} = ±30V, V _{DS} = 0V	I _{GSS}	--	--	±100	μA
Forward Transconductance ^(Note 4)	V _{DS} = 30V, I _D = 4A	g _{fs}	--	7.5	--	S
Dynamic						
Total Gate Charge ^(Note 4,5)	V _{DS} = 200V, I _D = 8A, V _{GS} = 10V	Q _g	--	8.4	--	nC
Gate-Source Charge ^(Note 4,5)		Q _{gs}	--	1.9	--	
Gate-Drain Charge ^(Note 4,5)		Q _{gd}	--	4	--	
Input Capacitance	V _{DS} = 25V, V _{GS} = 0V, f = 1.0MHz	C _{iss}	--	423	--	pF
Output Capacitance		C _{oss}	--	74	--	
Reverse Transfer Capacitance		C _{rss}	--	12	--	
Switching						
Turn-On Delay Time ^(Note 4,5)	V _{DD} = 125V, I _D = 8A, R _{GEN} = 25Ω	t _{d(on)}	--	14	--	ns
Turn-On Rise Time ^(Note 4,5)		t _r	--	25	--	
Turn-Off Delay Time ^(Note 4,5)		t _{d(off)}	--	30	--	
Turn-Off Fall Time ^(Note 4,5)		t _f	--	14	--	
Source-Drain Diode Ratings and Characteristic						
Maximum Continuous Drain-Source Diode Forward Current		I _S	--	--	8	A
Maximum Pulse Drain-Source Diode Forward Current		I _{SM}	--	--	32	A
Diode-Source Forward Voltage	V _{GS} = 0V, I _S = 8A	V _{SD}	--	--	1.5	V
Reverse Recovery Time ^(Note 4)	V _{GS} = 0V, I _S = 8A di/dt = 100A/μs	t _{rr}	--	157	--	ns
Reverse Recovery Charge ^(Note 4)		Q _{rr}	--	0.6	--	μC

Note:

- Pulse width limited by safe operating area
- L=3.68mH, I_{AS} =8A, V_{DD} = 50V, R_G = 25Ω, Starting T_J = 25°C
- I_{SD} ≤8A, di/dt ≤ 200A/μs, V_{DD} ≤ BV_{DS}, Starting T_J=25°C
- Pulse test: pulse width ≤300μs, duty cycle ≤2%
- Switching time is essentially independent of operating temperature.

Electrical Characteristics Curves

Output Characteristics

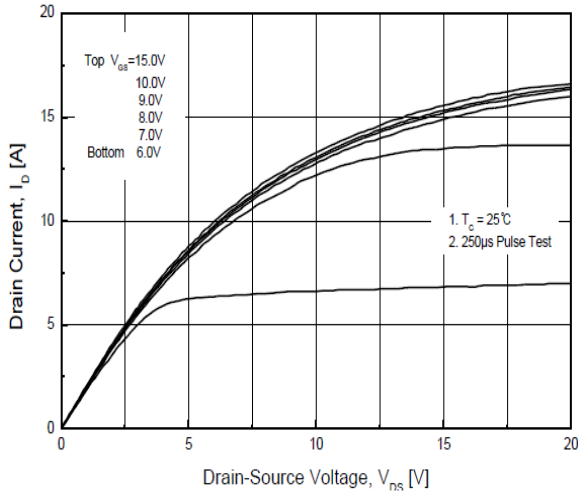

Transfer Characteristics

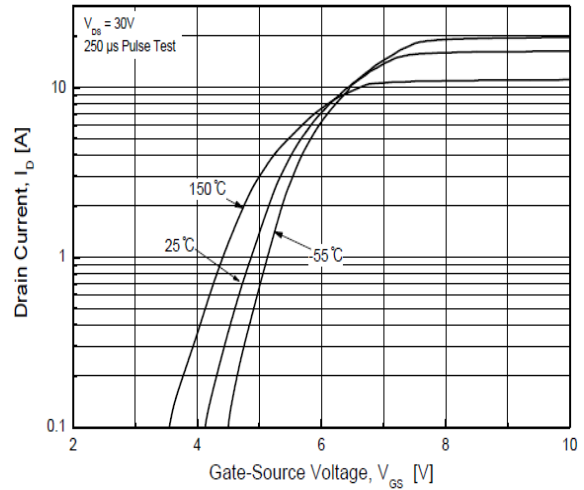

On-Resistance vs. Drain Current

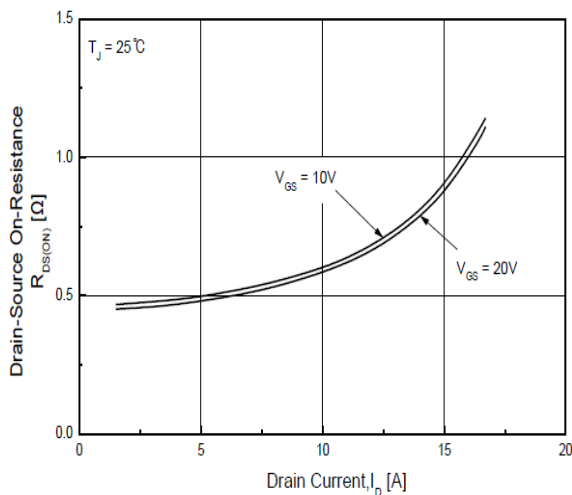

Gate Charge

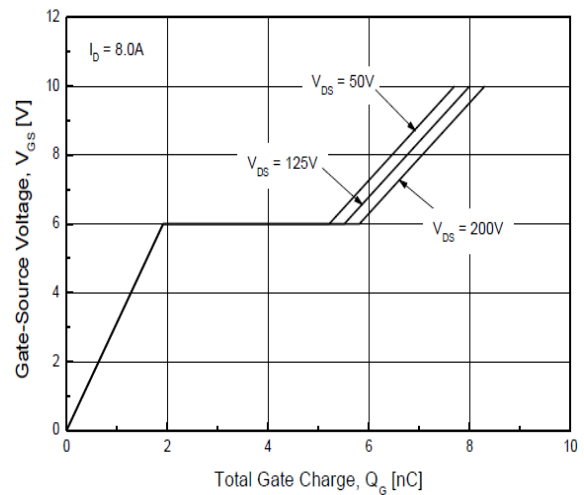

On-Resistance vs. Junction Temperature

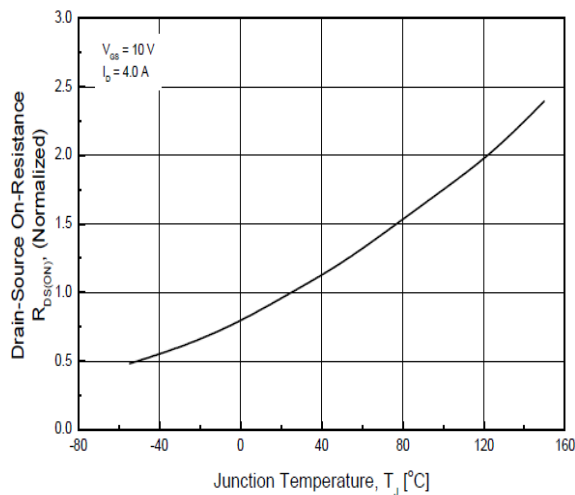

Source-Drain Diode Forward Voltage

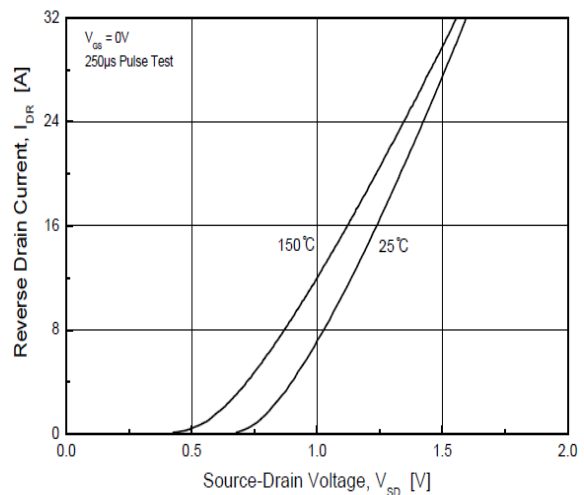

Electrical Characteristics Curves

Drain Current vs. Case Temperature

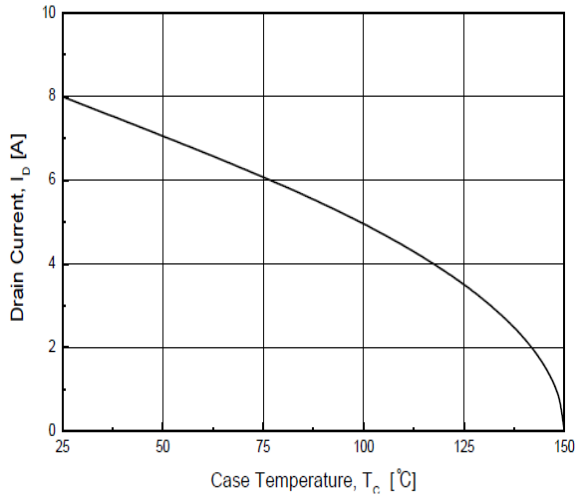

BV_{DSS} vs. Junction Temperature

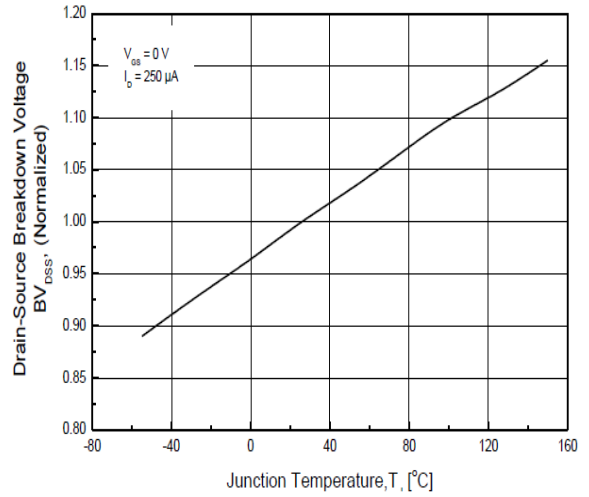

V_{TH} vs. Junction Temperature

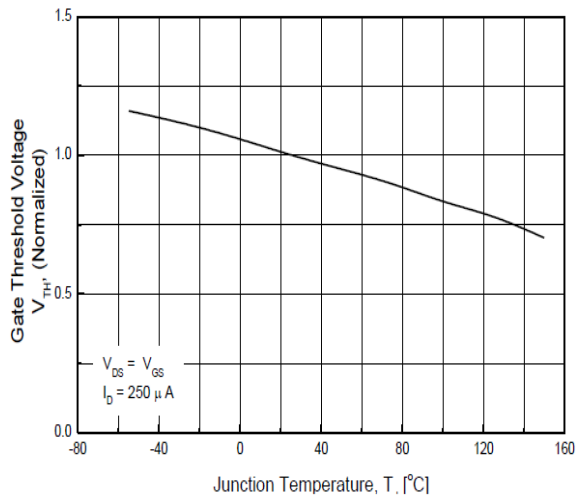

Capacitance vs. Drain-Source Voltage

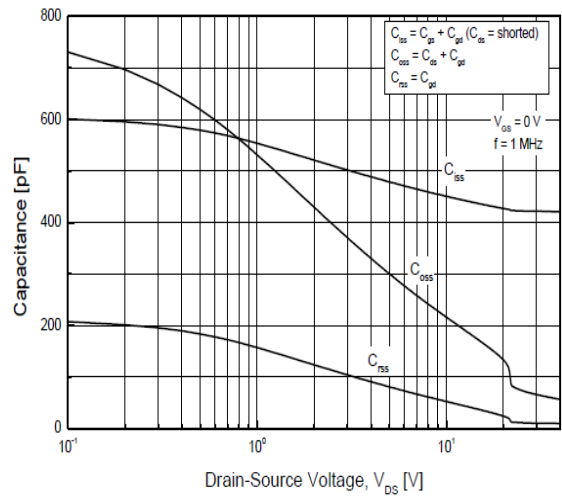

Maximum Safe Operating Area

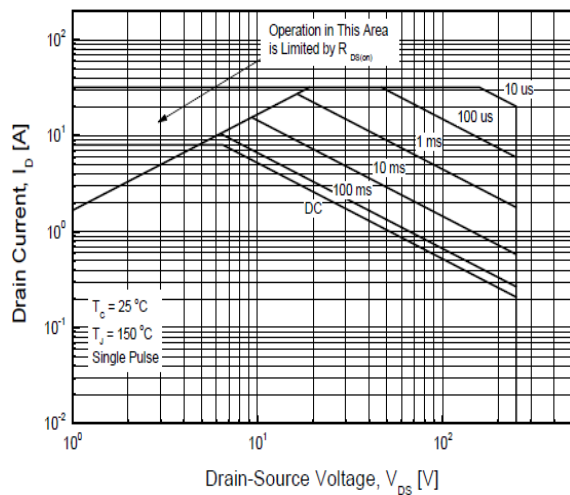

Transient Thermal Impedance

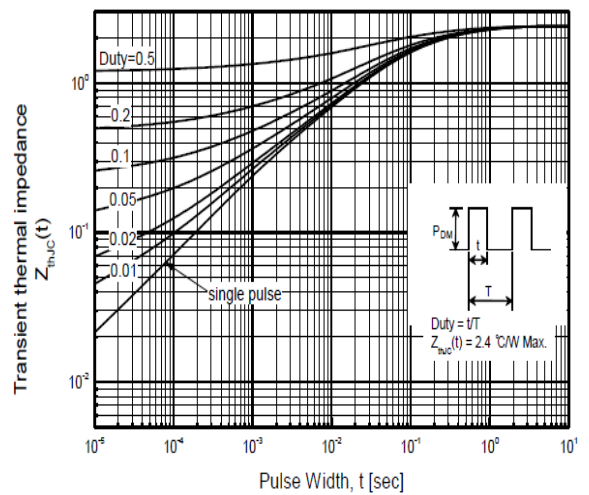



TO-251 Mechanical Drawing

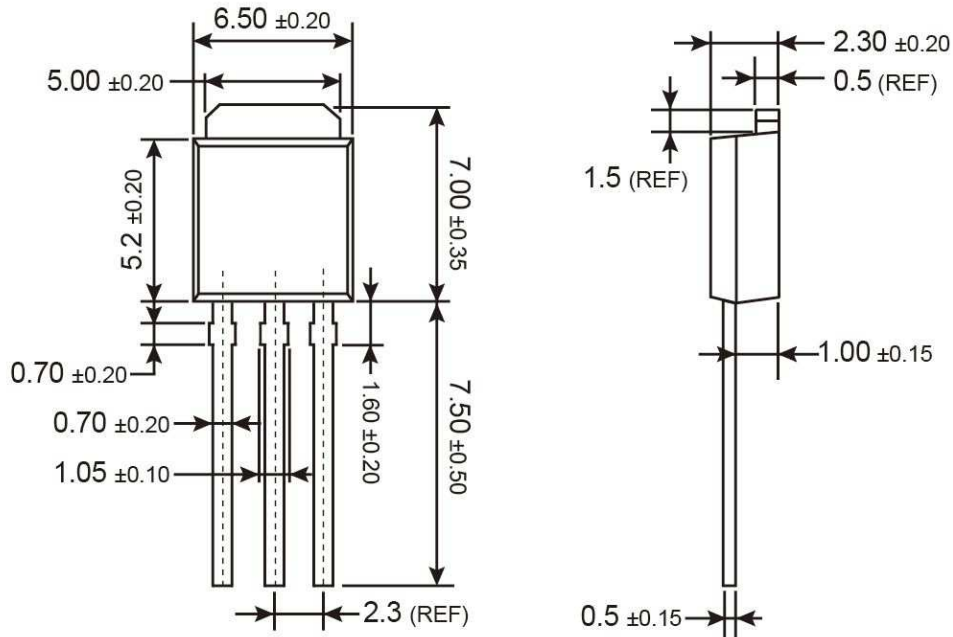

Unit: Millimeters

Marking Diagram

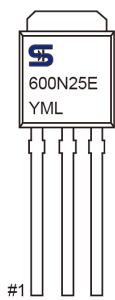

- Y** = Year Code
- M** = Month Code for Halogen Free Product
(**O**=Jan, **P**=Feb, **Q**=Mar, **R**=Apr, **S**=May, **T**=Jun, **U**=Jul, **V**=Aug, **W**=Sep, **X**=Oct, **Y**=Nov, **Z**=Dec)
- L** = Lot Code



TO-252 Mechanical Drawing

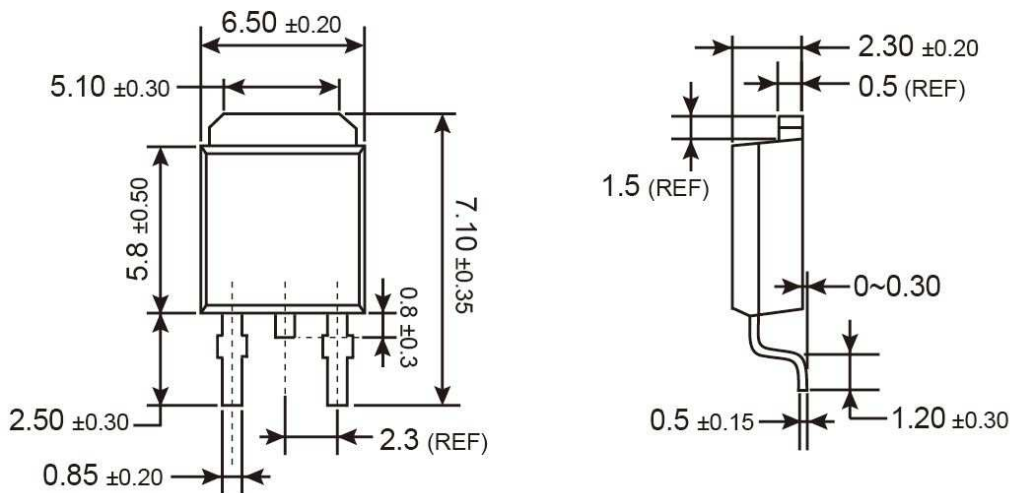

Unit: Millimeters

Marking Diagram

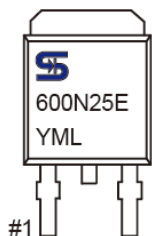

- Y** = Year Code
- M** = Month Code for Halogen Free Product
(**O**=Jan, **P**=Feb, **Q**=Mar, **R**=Apr, **S**=May, **T**=Jun, **U**=Jul, **V**=Aug, **W**=Sep, **X**=Oct, **Y**=Nov, **Z**=Dec)
- L** = Lot Code

Notice

Specifications of the products displayed herein are subject to change without notice. TSC or anyone on its behalf, assumes no responsibility or liability for any errors or inaccuracies.

Information contained herein is intended to provide a product description only. No license, express or implied, to any intellectual property rights is granted by this document. Except as provided in TSC's terms and conditions of sale for such products, TSC assumes no liability whatsoever, and disclaims any express or implied warranty, relating to sale and/or use of TSC products including liability or warranties relating to fitness for a particular purpose, merchantability, or infringement of any patent, copyright, or other intellectual property right.

The products shown herein are not designed for use in medical, life-saving, or life-sustaining applications. Customers using or selling these products for use in such applications do so at their own risk and agree to fully indemnify TSC for any damages resulting from such improper use or sale.

Компания «Life Electronics» занимается поставками электронных компонентов импортного и отечественного производства от производителей и со складов крупных дистрибьюторов Европы, Америки и Азии.

С конца 2013 года компания активно расширяет линейку поставок компонентов по направлению коаксиальный кабель, кварцевые генераторы и конденсаторы (керамические, пленочные, электролитические), за счёт заключения дистрибьюторских договоров

Мы предлагаем:

- Конкуренеспособные цены и скидки постоянным клиентам.
- Специальные условия для постоянных клиентов.
- Подбор аналогов.
- Поставку компонентов в любых объемах, удовлетворяющих вашим потребностям.
- Приемлемые сроки поставки, возможна ускоренная поставка.
- Доставку товара в любую точку России и стран СНГ.
- Комплексную поставку.
- Работу по проектам и поставку образцов.
- Формирование склада под заказчика.
- Сертификаты соответствия на поставляемую продукцию (по желанию клиента).
- Тестирование поставляемой продукции.
- Поставку компонентов, требующих военную и космическую приемку.
- Входной контроль качества.
- Наличие сертификата ISO.

В составе нашей компании организован Конструкторский отдел, призванный помогать разработчикам, и инженерам.

Конструкторский отдел помогает осуществить:

- Регистрацию проекта у производителя компонентов.
- Техническую поддержку проекта.
- Защиту от снятия компонента с производства.
- Оценку стоимости проекта по компонентам.
- Изготовление тестовой платы монтаж и пусконаладочные работы.



Тел: +7 (812) 336 43 04 (многоканальный)

Email: org@lifeelectronics.ru