

Important notice

Dear Customer,

On 7 February 2017 the former NXP Standard Product business became a new company with the tradename **Nexperia**. Nexperia is an industry leading supplier of Discrete, Logic and PowerMOS semiconductors with its focus on the automotive, industrial, computing, consumer and wearable application markets

In data sheets and application notes which still contain NXP or Philips Semiconductors references, use the references to Nexperia, as shown below.

Instead of <http://www.nxp.com>, <http://www.philips.com/> or <http://www.semiconductors.philips.com/>, use <http://www.nexperia.com>

Instead of sales.addresses@www.nxp.com or sales.addresses@www.semiconductors.philips.com, use salesaddresses@nexperia.com (email)

Replace the copyright notice at the bottom of each page or elsewhere in the document, depending on the version, as shown below:

- © NXP N.V. (year). All rights reserved or © Koninklijke Philips Electronics N.V. (year). All rights reserved

Should be replaced with:

- © **Nexperia B.V. (year). All rights reserved.**

If you have any questions related to the data sheet, please contact our nearest sales office via e-mail or telephone (details via salesaddresses@nexperia.com). Thank you for your cooperation and understanding,

Kind regards,

Team Nexperia

2N7002PW

60 V, 310 mA N-channel Trench MOSFET

Rev. 02 — 29 July 2010

Product data sheet

1. Product profile

1.1 General description

N-channel enhancement mode Field-Effect Transistor (FET) in a very small SOT323 (SC-70) Surface-Mounted Device (SMD) plastic package using Trench MOSFET technology.

1.2 Features and benefits

- AEC-Q101 qualified
- Logic-level compatible
- Trench MOSFET technology
- Very fast switching

1.3 Applications

- High-speed line driver
- Low-side loadswitch
- Relay driver
- Switching circuits

1.4 Quick reference data

Table 1. Quick reference data

Symbol	Parameter	Conditions	Min	Typ	Max	Unit
V_{DS}	drain-source voltage	$T_{amb} = 25\text{ °C}$	-	-	60	V
V_{GS}	gate-source voltage		-20	-	20	V
I_D	drain current	$V_{GS} = 10\text{ V}; T_{amb} = 25\text{ °C}$	[1]	-	310	mA
Static characteristics						
$R_{DS(on)}$	drain-source on-state resistance	$V_{GS} = 10\text{ V}; I_D = 500\text{ mA}; T_j = 25\text{ °C}; t_p \leq 300\text{ }\mu\text{s}; \text{ pulsed}; \delta \leq 0.01$	-	1	1.6	Ω

[1] Device mounted on an FR4 PCB, single-sided copper, tin-plated, mounting pad for drain 1 cm².



2. Pinning information

Table 2. Pinning information

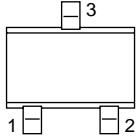
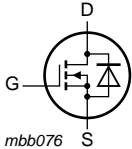
Pin	Symbol	Description	Simplified outline	Graphic symbol
1	G	gate		
2	S	source		
3	D	drain		

SOT323 (SC-70)

3. Ordering information

Table 3. Ordering information

Type number	Package		
	Name	Description	Version
2N7002PW	SC-70	plastic surface-mounted package; 3 leads	SOT323

4. Marking

Table 4. Marking codes

Type number	Marking code ^[1]
2N7002PW	X8%

[1] % = -: made in Hong Kong; % = p: made in Hong Kong; % = t: made in Malaysia; % = W: made in China

5. Limiting values

Table 5. Limiting values

In accordance with the Absolute Maximum Rating System (IEC 60134).

Symbol	Parameter	Conditions	Min	Max	Unit	
V_{DS}	drain-source voltage	$T_{amb} = 25\text{ °C}$	-	60	V	
V_{GS}	gate-source voltage		-20	20	V	
I_D	drain current	$V_{GS} = 10\text{ V}; T_{amb} = 25\text{ °C}$	[1]	-	310	mA
		$V_{GS} = 10\text{ V}; T_{amb} = 100\text{ °C}$	[1]	-	240	mA
I_{DM}	peak drain current	$T_{amb} = 25\text{ °C};$ single pulse; $t_p \leq 10\text{ }\mu\text{s}$	-	1.2	A	
P_{tot}	total power dissipation	$T_{amb} = 25\text{ °C}$	[2]	-	260	mW
			[1]	-	310	mW
		$T_{sp} = 25\text{ °C}$		-	830	mW
T_j	junction temperature		-	150	°C	
T_{amb}	ambient temperature		-55	150	°C	
T_{stg}	storage temperature		-65	150	°C	
Source-drain diode						
I_S	source current	$T_{amb} = 25\text{ °C}$	[1]	-	310	mA

[1] Device mounted on an FR4 PCB, single-sided copper, tin-plated, mounting pad for drain 1 cm².

[2] Device mounted on an FR4 Printed-Circuit Board (PCB), single-sided copper, tin-plated and standard footprint.

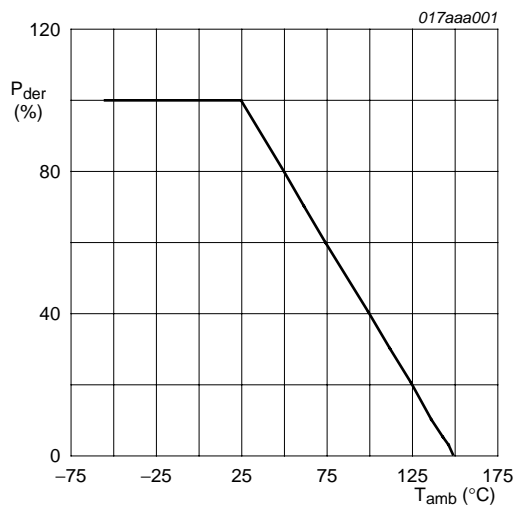

$$P_{der} = \frac{P_{tot}}{P_{tot(25^{\circ}\text{C})}} \times 100\%$$

Fig 1. Normalized total power dissipation as a function of ambient temperature

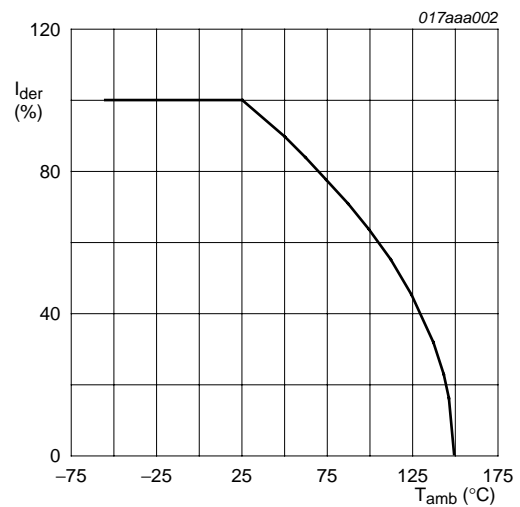

$$I_{der} = \frac{I_D}{I_{D(25^{\circ}\text{C})}} \times 100\%$$

Fig 2. Normalized continuous drain current as a function of ambient temperature

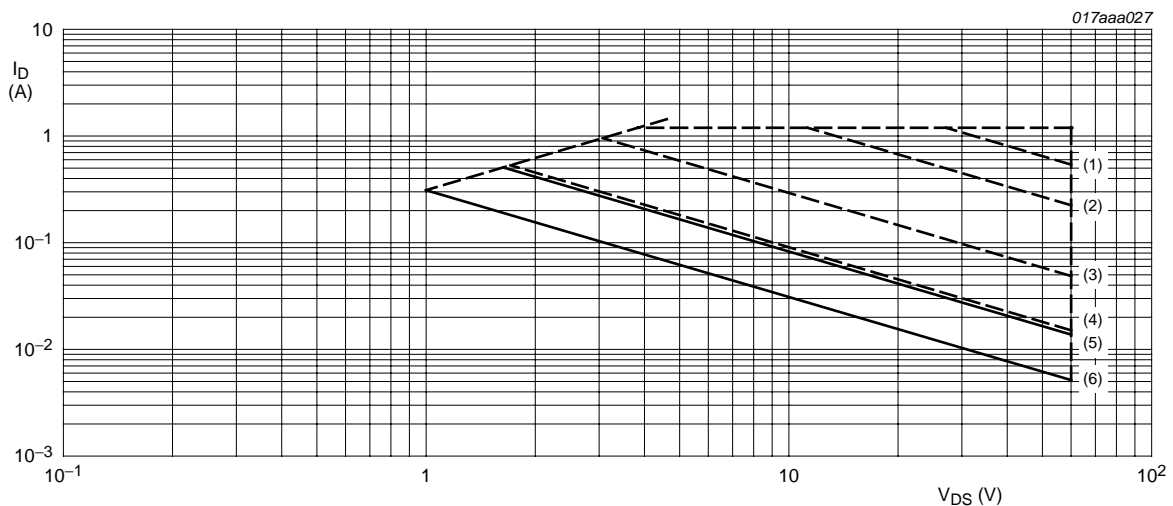

I_{DM} = single pulse

(1) $t_p = 100 \mu\text{s}$

(2) $t_p = 1 \text{ ms}$

(3) $t_p = 10 \text{ ms}$

(4) $t_p = 100 \text{ ms}$

(5) DC; $T_{sp} = 25^{\circ}\text{C}$

(6) DC; $T_{amb} = 25^{\circ}\text{C}$; drain mounting pad 1 cm^2

Fig 3. Safe operating area; junction to ambient; continuous and peak drain currents as a function of drain-source voltage

6. Thermal characteristics

Table 6. Thermal characteristics

Symbol	Parameter	Conditions	Min	Typ	Max	Unit	
$R_{th(j-a)}$	thermal resistance from junction to ambient	in free air	[1]	-	415	480	K/W
			[2]	-	350	400	K/W
$R_{th(j-sp)}$	thermal resistance from junction to solder point		-	-	150	K/W	

[1] Device mounted on an FR4 PCB, single-sided copper, tin-plated and standard footprint.

[2] Device mounted on an FR4 PCB, single-sided copper, tin-plated, mounting pad for drain 1 cm².

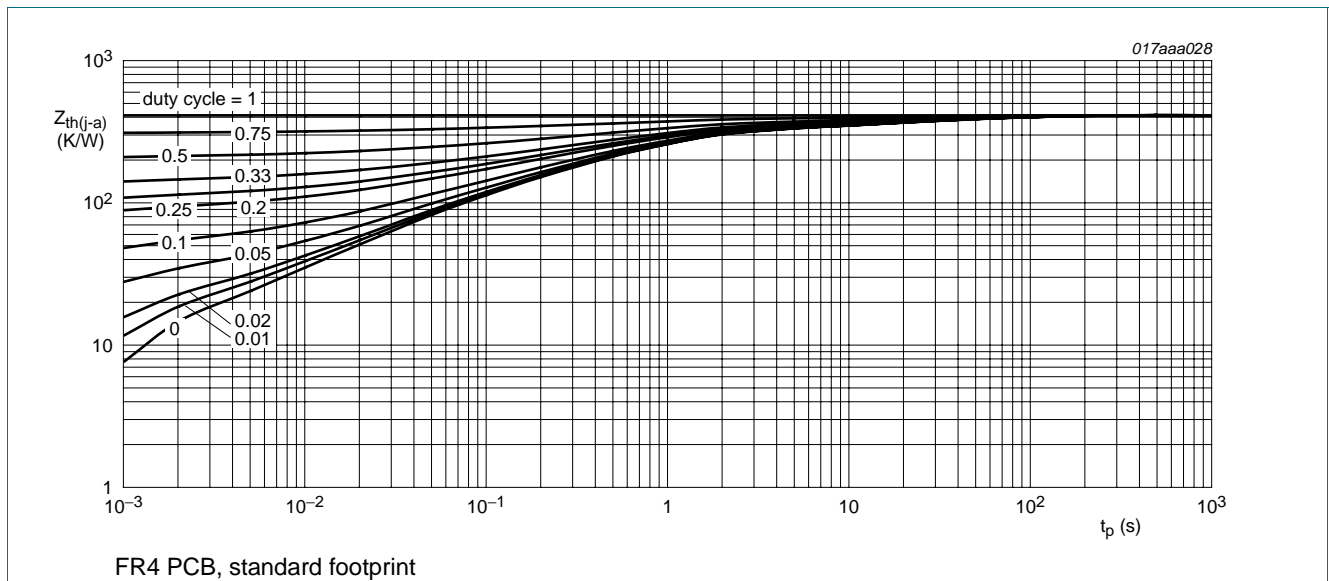

Fig 4. Transient thermal impedance from junction to ambient as a function of pulse duration; typical values

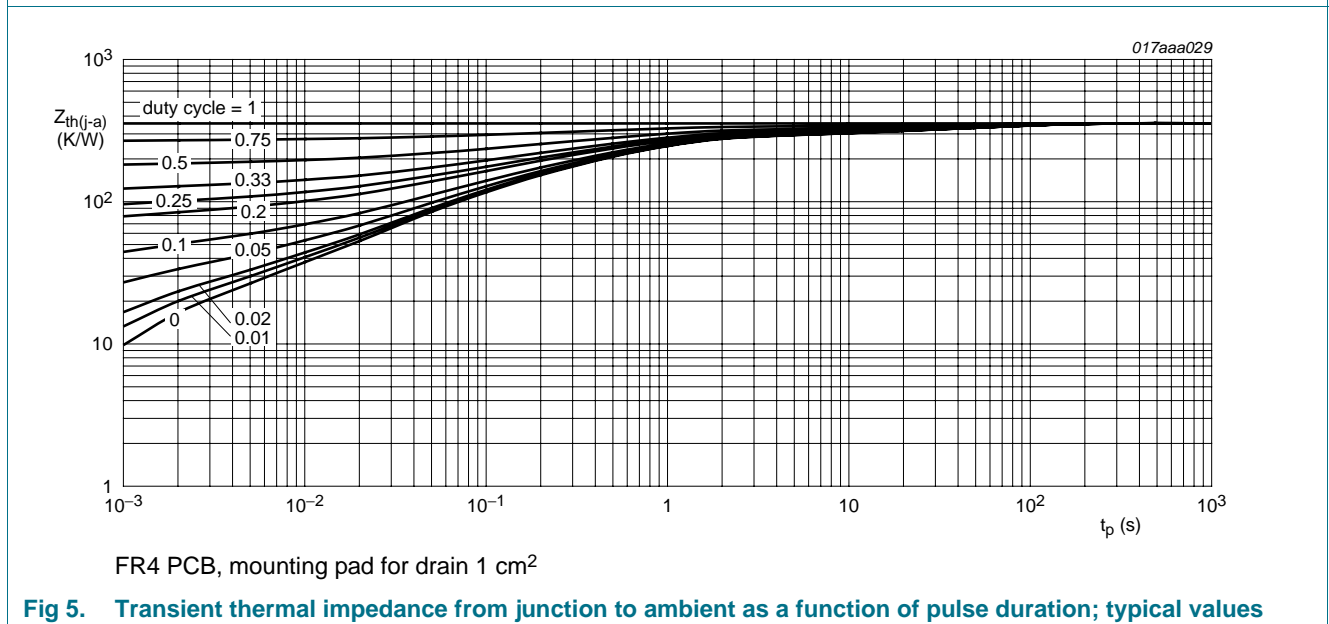

Fig 5. Transient thermal impedance from junction to ambient as a function of pulse duration; typical values

7. Characteristics

Table 7. Characteristics

Symbol	Parameter	Conditions	Min	Typ	Max	Unit
Static characteristics						
$V_{(BR)DSS}$	drain-source breakdown voltage	$I_D = 10 \mu\text{A}$; $V_{GS} = 0 \text{ V}$; $T_j = 25 \text{ }^\circ\text{C}$	60	-	-	V
V_{GSth}	gate-source threshold voltage	$I_D = 250 \mu\text{A}$; $V_{DS} = V_{GS}$; $T_j = 25 \text{ }^\circ\text{C}$	1.1	1.75	2.4	V
I_{DSS}	drain leakage current	$V_{DS} = 60 \text{ V}$; $V_{GS} = 0 \text{ V}$; $T_j = 25 \text{ }^\circ\text{C}$	-	-	1	μA
		$V_{DS} = 60 \text{ V}$; $V_{GS} = 0 \text{ V}$; $T_j = 150 \text{ }^\circ\text{C}$	-	-	10	μA
I_{GSS}	gate leakage current	$V_{GS} = 20 \text{ V}$; $V_{DS} = 0 \text{ V}$; $T_j = 25 \text{ }^\circ\text{C}$	-	-	100	nA
		$V_{GS} = -20 \text{ V}$; $V_{DS} = 0 \text{ V}$; $T_j = 25 \text{ }^\circ\text{C}$	-	-	100	nA
R_{DSon}	drain-source on-state resistance	$V_{GS} = 5 \text{ V}$; $I_D = 50 \text{ mA}$; pulsed; $t_p \leq 300 \mu\text{s}$; $\delta \leq 0.01$; $T_j = 25 \text{ }^\circ\text{C}$	-	1.3	2	Ω
		$V_{GS} = 10 \text{ V}$; $I_D = 500 \text{ mA}$; pulsed; $t_p \leq 300 \mu\text{s}$; $\delta \leq 0.01$; $T_j = 25 \text{ }^\circ\text{C}$	-	1	1.6	Ω
g_{fs}	forward transconductance	$V_{DS} = 10 \text{ V}$; $I_D = 200 \text{ mA}$; pulsed; $t_p \leq 300 \mu\text{s}$; $\delta \leq 0.01$; $T_j = 25 \text{ }^\circ\text{C}$	-	400	-	mS
Dynamic characteristics						
$Q_{G(tot)}$	total gate charge	$I_D = 300 \text{ mA}$; $V_{DS} = 30 \text{ V}$; $V_{GS} = 4.5 \text{ V}$; $T_j = 25 \text{ }^\circ\text{C}$	-	0.6	0.8	nC
Q_{GS}	gate-source charge		-	0.2	-	nC
Q_{GD}	gate-drain charge		-	0.2	-	nC
C_{iss}	input capacitance	$V_{GS} = 0 \text{ V}$; $V_{DS} = 10 \text{ V}$; $f = 1 \text{ MHz}$; $T_j = 25 \text{ }^\circ\text{C}$	-	30	50	pF
C_{oss}	output capacitance		-	7	-	pF
C_{rss}	reverse transfer capacitance		-	4	-	pF
$t_{d(on)}$	turn-on delay time	$V_{DS} = 50 \text{ V}$; $R_L = 250 \Omega$; $V_{GS} = 10 \text{ V}$; $R_{G(ext)} = 6 \Omega$; $T_j = 25 \text{ }^\circ\text{C}$	-	3	6	ns
t_r	rise time		-	4	-	ns
$t_{d(off)}$	turn-off delay time		-	10	20	ns
t_f	fall time		-	5	-	ns
Source-drain diode						
V_{SD}	source-drain voltage	$I_S = 115 \text{ mA}$; $V_{GS} = 0 \text{ V}$; $T_j = 25 \text{ }^\circ\text{C}$	0.47	0.75	1.1	V

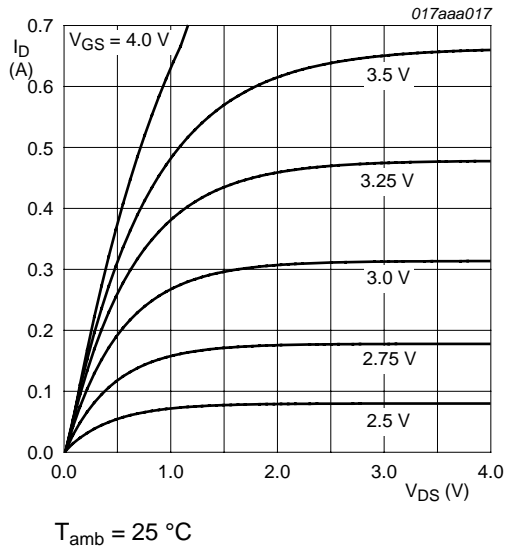

Fig 6. Output characteristics: drain current as a function of drain-source voltage; typical values

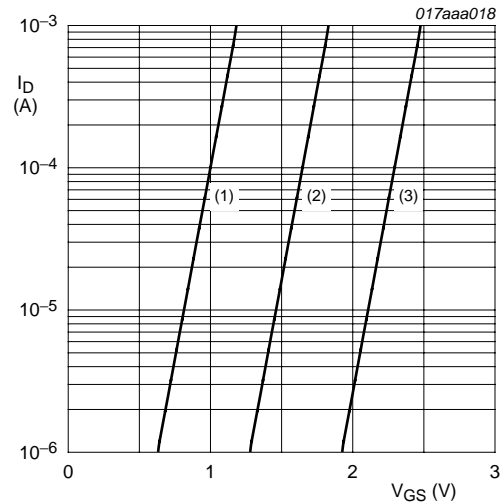

Fig 7. Sub-threshold drain current as a function of gate-source voltage

$T_{amb} = 25\text{ °C}; V_{DS} = 5\text{ V}$
 (1) minimum values
 (2) typical values
 (3) maximum values

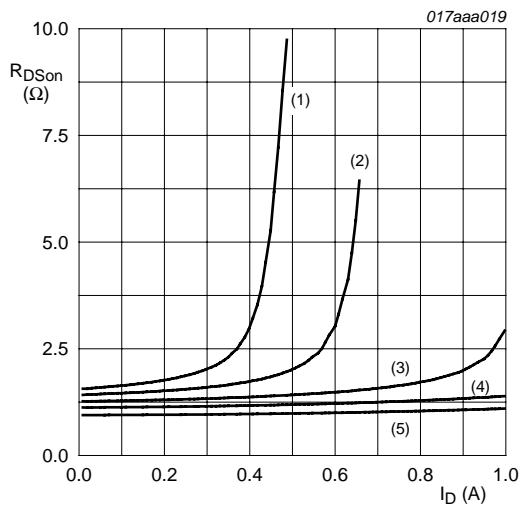

Fig 8. Drain-source on-state resistance as a function of drain current; typical values

$T_{amb} = 25\text{ °C}$
 (1) $V_{GS} = 3.25\text{ V}$
 (2) $V_{GS} = 3.5\text{ V}$
 (3) $V_{GS} = 4\text{ V}$
 (4) $V_{GS} = 5\text{ V}$
 (5) $V_{GS} = 10\text{ V}$

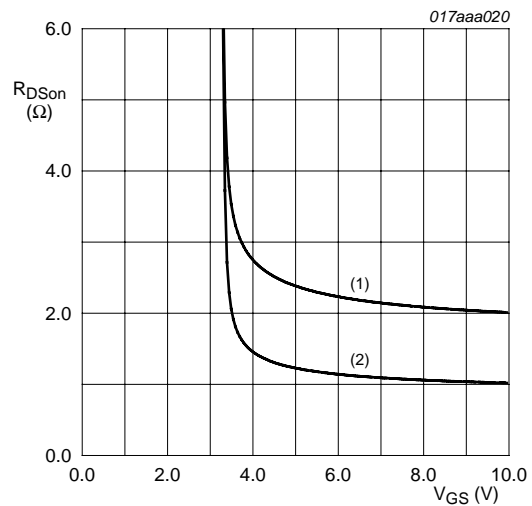
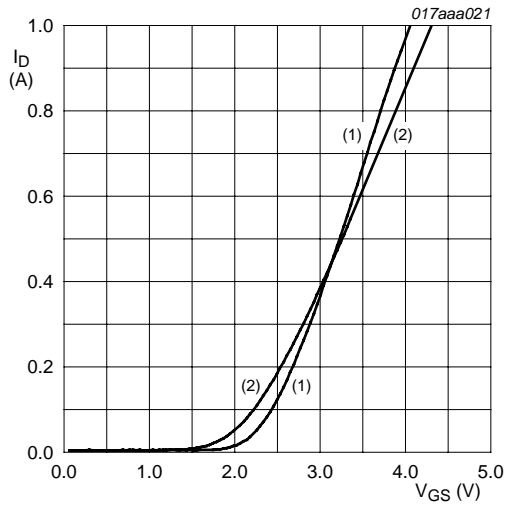

Fig 9. Drain-source on-state resistance as a function of gate-source voltage; typical values

$I_D = 500\text{ mA}$
 (1) $T_{amb} = 150\text{ °C}$
 (2) $T_{amb} = 25\text{ °C}$



$V_{DS} > I_D \times R_{DS(on)}$
 (1) $T_{amb} = 25\text{ °C}$
 (2) $T_{amb} = 150\text{ °C}$

Fig 10. Transfer characteristics: drain current as a function of gate-source voltage; typical values

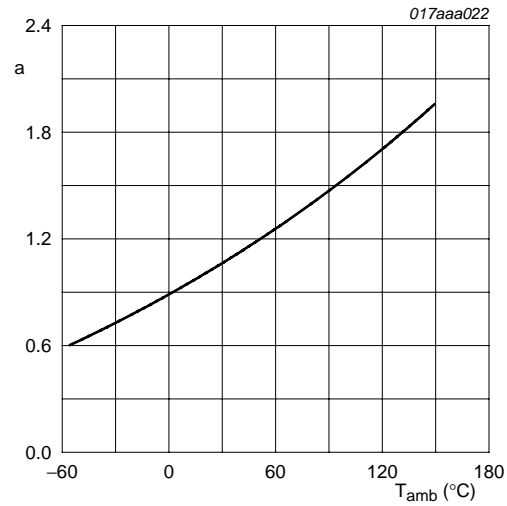

$$a = \frac{R_{DS(on)}}{R_{DS(on)25\text{°C}}}$$

Fig 11. Normalized drain-source on-state resistance as a function of ambient temperature; typical values

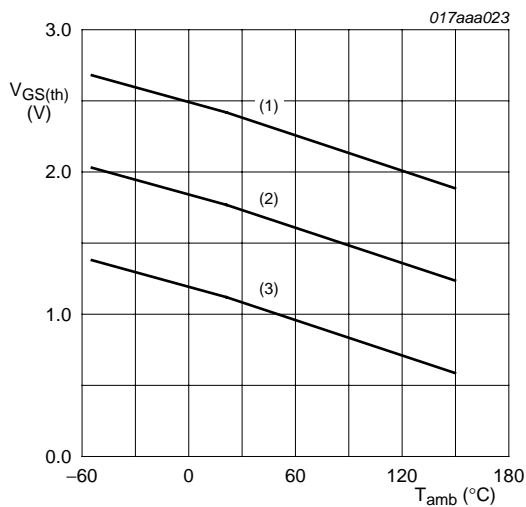

$I_D = 0.25\text{ mA}; V_{DS} = V_{GS}$
 (1) maximum values
 (2) typical values
 (3) minimum values

Fig 12. Gate-source threshold voltage as a function of ambient temperature

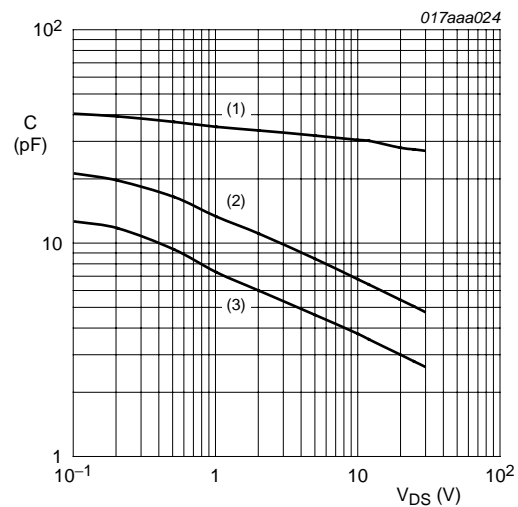

$f = 1\text{ MHz}; V_{GS} = 0\text{ V}$
 (1) C_{iss}
 (2) C_{oss}
 (3) C_{rss}

Fig 13. Input, output and reverse transfer capacitances as a function of drain-source voltage; typical values

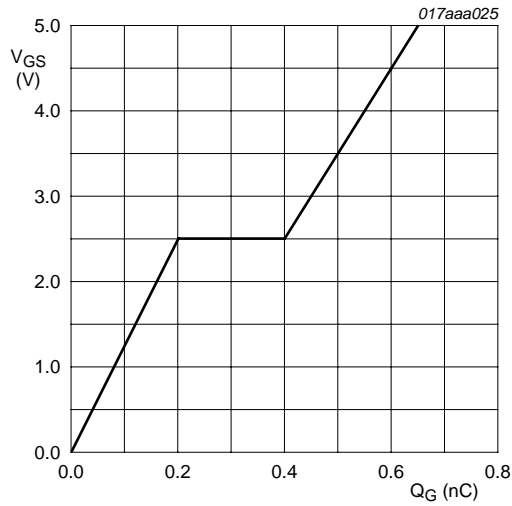

$I_D = 300 \text{ mA}$; $V_{DS} = 30 \text{ V}$; $T_{amb} = 25 \text{ }^\circ\text{C}$

Fig 14. Gate-source voltage as a function of gate charge; typical values

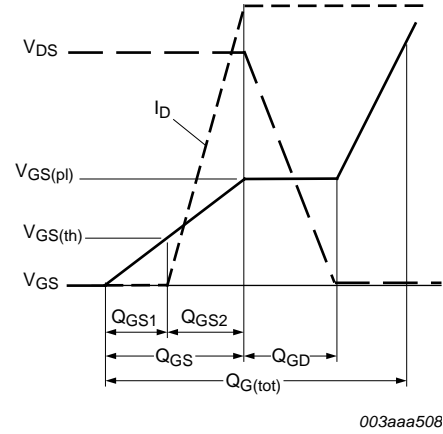
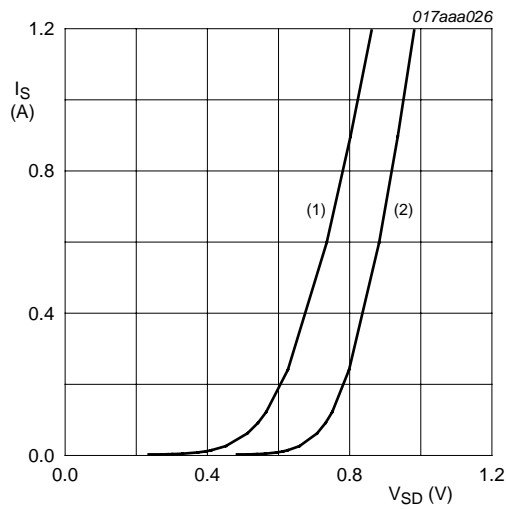

Fig 15. Gate charge waveform definitions



$V_{GS} = 0 \text{ V}$
 (1) $T_{amb} = 150 \text{ }^\circ\text{C}$
 (2) $T_{amb} = 25 \text{ }^\circ\text{C}$

Fig 16. Source current as a function of source-drain voltage; typical values

8. Test information

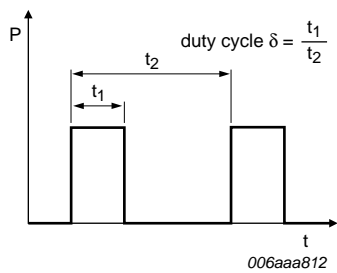

Fig 17. Duty cycle definition

9. Package outline

Plastic surface-mounted package; 3 leads

SOT323

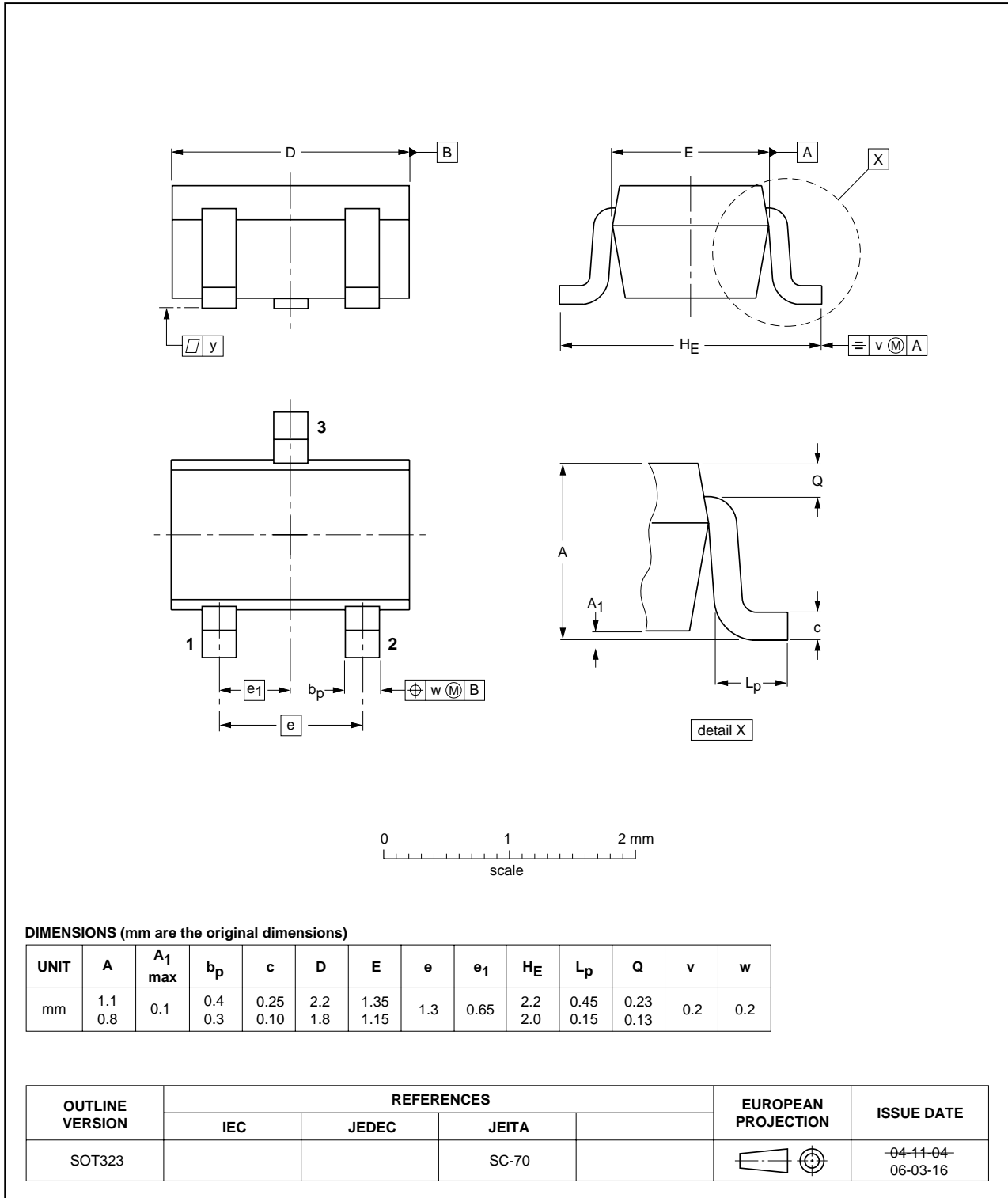

Fig 18. Package outline SOT323 (SC-70)

10. Soldering

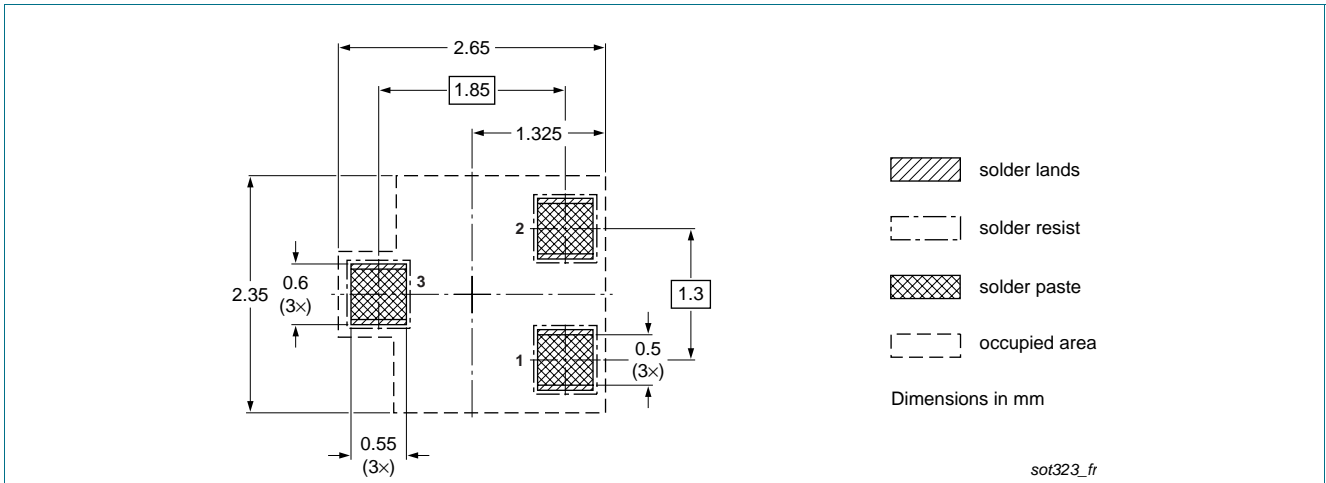

Fig 19. Reflow soldering footprint for SOT323 (SC-70)

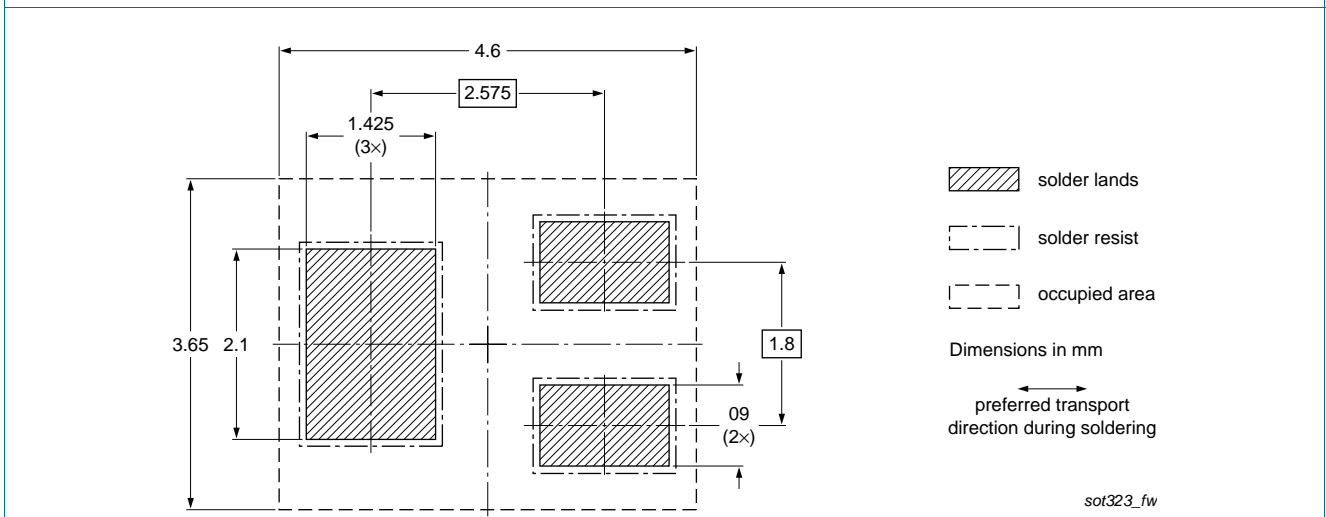

Fig 20. Wave soldering footprint for SOT323 (SC-70)

11. Revision history

Table 8. Revision history

Document ID	Release date	Data sheet status	Change notice	Supersedes
2N7002PW v.2	20100729	Product data sheet	-	2N7002PW_1
Modifications:	<ul style="list-style-type: none">• Correction of thermal values.• Correction of various characteristics values including related graphs.			
2N7002PW_1	20100422	Product data sheet	-	-

12. Legal information

12.1 Data sheet status

Document status ^{[1][2]}	Product status ^[3]	Definition
Objective [short] data sheet	Development	This document contains data from the objective specification for product development.
Preliminary [short] data sheet	Qualification	This document contains data from the preliminary specification.
Product [short] data sheet	Production	This document contains the product specification.

[1] Please consult the most recently issued document before initiating or completing a design.

[2] The term 'short data sheet' is explained in section "Definitions".

[3] The product status of device(s) described in this document may have changed since this document was published and may differ in case of multiple devices. The latest product status information is available on the Internet at URL <http://www.nxp.com>.

12.2 Definitions

Draft — The document is a draft version only. The content is still under internal review and subject to formal approval, which may result in modifications or additions. NXP Semiconductors does not give any representations or warranties as to the accuracy or completeness of information included herein and shall have no liability for the consequences of use of such information.

Short data sheet — A short data sheet is an extract from a full data sheet with the same product type number(s) and title. A short data sheet is intended for quick reference only and should not be relied upon to contain detailed and full information. For detailed and full information see the relevant full data sheet, which is available on request via the local NXP Semiconductors sales office. In case of any inconsistency or conflict with the short data sheet, the full data sheet shall prevail.

Product specification — The information and data provided in a Product data sheet shall define the specification of the product as agreed between NXP Semiconductors and its customer, unless NXP Semiconductors and customer have explicitly agreed otherwise in writing. In no event however, shall an agreement be valid in which the NXP Semiconductors product is deemed to offer functions and qualities beyond those described in the Product data sheet.

12.3 Disclaimers

Limited warranty and liability — Information in this document is believed to be accurate and reliable. However, NXP Semiconductors does not give any representations or warranties, expressed or implied, as to the accuracy or completeness of such information and shall have no liability for the consequences of use of such information.

In no event shall NXP Semiconductors be liable for any indirect, incidental, punitive, special or consequential damages (including - without limitation - lost profits, lost savings, business interruption, costs related to the removal or replacement of any products or rework charges) whether or not such damages are based on tort (including negligence), warranty, breach of contract or any other legal theory.

Notwithstanding any damages that customer might incur for any reason whatsoever, NXP Semiconductors' aggregate and cumulative liability towards customer for the products described herein shall be limited in accordance with the *Terms and conditions of commercial sale* of NXP Semiconductors.

Right to make changes — NXP Semiconductors reserves the right to make changes to information published in this document, including without limitation specifications and product descriptions, at any time and without notice. This document supersedes and replaces all information supplied prior to the publication hereof.

Suitability for use — NXP Semiconductors products are not designed, authorized or warranted to be suitable for use in life support, life-critical or safety-critical systems or equipment, nor in applications where failure or malfunction of an NXP Semiconductors product can reasonably be expected to result in personal injury, death or severe property or environmental damage. NXP Semiconductors accepts no liability for inclusion and/or use of NXP Semiconductors products in such equipment or applications and therefore such inclusion and/or use is at the customer's own risk.

Applications — Applications that are described herein for any of these products are for illustrative purposes only. NXP Semiconductors makes no representation or warranty that such applications will be suitable for the specified use without further testing or modification.

Customers are responsible for the design and operation of their applications and products using NXP Semiconductors products, and NXP Semiconductors accepts no liability for any assistance with applications or customer product design. It is customer's sole responsibility to determine whether the NXP Semiconductors product is suitable and fit for the customer's applications and products planned, as well as for the planned application and use of customer's third party customer(s). Customers should provide appropriate design and operating safeguards to minimize the risks associated with their applications and products.

NXP Semiconductors does not accept any liability related to any default, damage, costs or problem which is based on any weakness or default in the customer's applications or products, or the application or use by customer's third party customer(s). Customer is responsible for doing all necessary testing for the customer's applications and products using NXP Semiconductors products in order to avoid a default of the applications and the products or of the application or use by customer's third party customer(s). NXP does not accept any liability in this respect.

Limiting values — Stress above one or more limiting values (as defined in the Absolute Maximum Ratings System of IEC 60134) will cause permanent damage to the device. Limiting values are stress ratings only and (proper) operation of the device at these or any other conditions above those given in the Recommended operating conditions section (if present) or the Characteristics sections of this document is not warranted. Constant or repeated exposure to limiting values will permanently and irreversibly affect the quality and reliability of the device.

Terms and conditions of commercial sale — NXP Semiconductors products are sold subject to the general terms and conditions of commercial sale, as published at <http://www.nxp.com/profile/terms>, unless otherwise agreed in a valid written individual agreement. In case an individual agreement is concluded only the terms and conditions of the respective agreement shall apply. NXP Semiconductors hereby expressly objects to applying the customer's general terms and conditions with regard to the purchase of NXP Semiconductors products by customer.

No offer to sell or license — Nothing in this document may be interpreted or construed as an offer to sell products that is open for acceptance or the grant, conveyance or implication of any license under any copyrights, patents or other industrial or intellectual property rights.

Export control — This document as well as the item(s) described herein may be subject to export control regulations. Export might require a prior authorization from national authorities.

Quick reference data — The Quick reference data is an extract of the product data given in the Limiting values and Characteristics sections of this document, and as such is not complete, exhaustive or legally binding.

12.4 Trademarks

Notice: All referenced brands, product names, service names and trademarks are the property of their respective owners.

Adelante, Bitport, Bitsound, CoolFlux, CoReUse, DESFire, EZ-HV, FabKey, GreenChip, HiPerSmart, HITAG, I²C-bus logo, ICODE, I-CODE, ITEC, Labelution, MIFARE, MIFARE Plus, MIFARE Ultralight, MoReUse, QLPAK, Silicon Tuner, SiliconMAX, SmartXA, STARplug, TOPFET, TrenchMOS, TriMedia and UCODE — are trademarks of NXP B.V.

HD Radio and HD Radio logo — are trademarks of iBiquity Digital Corporation.

13. Contact information

For more information, please visit: <http://www.nxp.com>

For sales office addresses, please send an email to: salesaddresses@nxp.com

14. Contents

1	Product profile	1
1.1	General description	1
1.2	Features and benefits	1
1.3	Applications	1
1.4	Quick reference data	1
2	Pinning information	2
3	Ordering information	2
4	Marking	2
5	Limiting values	2
6	Thermal characteristics	4
7	Characteristics	5
8	Test information	9
9	Package outline	10
10	Soldering	11
11	Revision history	12
12	Legal information	13
12.1	Data sheet status	13
12.2	Definitions	13
12.3	Disclaimers	13
12.4	Trademarks	14
13	Contact information	14

Please be aware that important notices concerning this document and the product(s) described herein, have been included in section 'Legal information'.

© NXP B.V. 2010.

All rights reserved.

For more information, please visit: <http://www.nxp.com>

For sales office addresses, please send an email to: salesaddresses@nxp.com

Date of release: 29 July 2010

Document identifier: 2N7002PW

Компания «Life Electronics» занимается поставками электронных компонентов импортного и отечественного производства от производителей и со складов крупных дистрибьюторов Европы, Америки и Азии.

С конца 2013 года компания активно расширяет линейку поставок компонентов по направлению коаксиальный кабель, кварцевые генераторы и конденсаторы (керамические, пленочные, электролитические), за счёт заключения дистрибьюторских договоров

Мы предлагаем:

- Конкурентоспособные цены и скидки постоянным клиентам.
- Специальные условия для постоянных клиентов.
- Подбор аналогов.
- Поставку компонентов в любых объемах, удовлетворяющих вашим потребностям.
- Приемлемые сроки поставки, возможна ускоренная поставка.
- Доставку товара в любую точку России и стран СНГ.
- Комплексную поставку.
- Работу по проектам и поставку образцов.
- Формирование склада под заказчика.
- Сертификаты соответствия на поставляемую продукцию (по желанию клиента).
- Тестирование поставляемой продукции.
- Поставку компонентов, требующих военную и космическую приемку.
- Входной контроль качества.
- Наличие сертификата ISO.

В составе нашей компании организован Конструкторский отдел, призванный помогать разработчикам, и инженерам.

Конструкторский отдел помогает осуществить:

- Регистрацию проекта у производителя компонентов.
- Техническую поддержку проекта.
- Защиту от снятия компонента с производства.
- Оценку стоимости проекта по компонентам.
- Изготовление тестовой платы монтаж и пусконаладочные работы.



Тел: +7 (812) 336 43 04 (многоканальный)
Email: org@lifeelectronics.ru