

# Future Technology Devices International Ltd.

## FT930/1/2/3 (Embedded Microcontroller)



The FT93x series includes the FT930, FT931, FT932 and FT933 which are complete System-On-Chip 32-bit RISC microcontrollers for USB to multi-interface bridging and embedded applications featuring a high level of integration and low power consumption. With a D2XX<sup>1</sup> hardware engine built-in, it is compatible with D2XX drivers. It has the following features:

- High performance, low power mixed 16-bit/32-bit FT32B core processor, running at a frequency of 100MHz.
- 128kB on-chip Flash memory.
- 128kB on-chip shadow program memory.
- True Zero Wait States (OWS) up to 3.1 DMIPS per MHz performance.
- 32kB on-chip data memory.
- Integrated Phase-Locked Loop (PLL) supports single external 12MHz crystal and direct external clock source input.
- Real Time Clock (RTC) with automatic calibration to compensate for inaccuracies in low-cost 32.768 kHz crystal or other input source.
- D2XX hardware engine (USB 2.0 Device) with up to 7 interfaces
- One USB 2.0 Device controller supports high-speed (480 Mbit/s) and full-speed (12 Mbit/s).
- USB2.0 Device controller supports Isochronous, Interrupt, Control, and Bulk transfers for up to 15 endpoints
- Supports One-Wire for firmware download and software debugging.
- One SPI Master supports single/dual/quad modes of data transfer. Clock rate is up to 25 MHz
- One SPI Slave supports single data transfer up to 25MHz.
- SD Host Controller conformant to SDA SD Host Controller specification V3.0, running up to 25 MHz and software support for SD/SDHC/SDXC cards
- I2C bus interfaces may be configured as master or slave, supporting standard/fast /fast plus/high speed mode data transfers. Max data transfer rate up to 3.4 Mbit/s. Clock stretching is supported.
- Four UARTs configurable as two full UART interfaces or 4 half UART interfaces
- Four 16-bit timers with prescaler and one 32-bit watchdog timer.
- Supports eight independent PWM channels. PWM Channel 0 and 1 may be configured as stereo audio output channels, supporting PCM 8-bit/16-bit stereo data.
- Supports two independent 10-bit DACs. DAC 0/1 channel output. Sample rate of ~1MS/s.
- Supports three 8-bit ADC1/2/3 channel input. Sample rate of ~480KS/s.
- Single 3.3 volt power supply, built-in 1.2 V regulator.
- 3.3 volt I/O power supply, all GPIO pins are 5V tolerant.
- Supports USB Battery Charging Specification Rev 1.2.
- Power-On Reset (POR).
- -40°C to 85°C extended operating temperature range.
- Available in compact Pb-free, RoHS compliant 68 to 48-pin packages.

Neither the whole nor any part of the information contained in, or the product described in this manual, may be adapted or reproduced in any material or electronic form without the prior written consent of the copyright holder. This product and its documentation are supplied on an as-is basis and no warranty as to their suitability for any particular purpose is either made or implied Bridgetek Pte Ltd will not accept any claim for damages howsoever arising as a result of use or failure of this product. Your statutory rights are not affected. This product or any variant of it is not intended for use in any medical appliance, device or system in which the failure of the product might reasonably be expected to result in personal injury. This document provides preliminary information that may be subject to change without notice. No freedom to use patents or other intellectual property rights is implied by the publication of this document. Bridgetek Pte Ltd, 178 Paya Lebar Road, #07-03, Singapore 409030. Singapore Registered Company Number: 201542387H

<sup>1</sup> Used under agreement between BRT and FTDI, D2XX is the popular FTDI USB driver used on its FT2xx USB UART/FIFO Bridge platforms. It can be accessed directly or through a virtual COM port.

## 1 Typical Applications

- Companion with FT81x for multi-screen display
- USB to multiple interface bridging (up to 15 end points)
- Motor drive and application control
- E-meter
- DAQ System Industrial automation
- Medical appliances
- Instrumentation

### 1.1 Part Numbers

Part Number	Package
FT930Q-X	68 Pin QFN, pitch 0.4mm, body 8mm x 8mm x 0.85mm, supports ADC/DAC, SD-Card, and RTC features.
FT931Q-X	56 Pin QFN, pitch 0.5mm, body 8mm x 8mm x 0.85mm, supports ADC/DAC, SD-Card, and RTC features.
FT932Q-X	48 Pin QFN, pitch 0.5mm, body 7mm x 7mm x 0.85mm, supports ADC/DAC and SD-Card features, no RTC feature.
FT933Q-X	48 Pin QFN, pitch 0.5mm, body 7mm x 7mm x 0.85mm, supports ADC feature, no SD-Card and no RTC features.

**Table 1-1 FT93x Series Part Numbers**

Packaging codes for X:

Packaging Code	Part	Packing	Qty
-R	FT93x	Tape and Reel	3000
-T	FT930 FT931	Tray Packing	348
	FT932 FT933	Tray Packing	260

## 1.2 Part Comparison Chart

	FT930	FT931	FT932	FT933
Flash (Kbytes)	128			
SRAM (Kbytes)	32			
Package	QFN-68	QFN-56	QFN-48	QFN-48
UART 0 / 1	X	X	X	X
UART 2 / 3	X			
SPI Master	X	X	X	X
SPI Slave	X	X	X	X
I2C Master / Slave	X	X	X	X
RTC	X	X		
DAC 0 / 1	X	X	X	
ADC 1	X	X	X	
ADC 2 / 3	X	X	X	X
USB Device	X	X	X	X
PWM 0 - 3	X	X	X	X
PWM 4 - 7	X	X	X	
SD Host Controller	X	X	X	
Debugger	X	X	X	X

**Table 1-2 FT93x Series Comparison**

## 1.3 USB2.0 Compliant

The FT93x series microcontroller contains a Device controller that is compliant with the USB2.0 specification.

## 2 FT930 Block Diagram

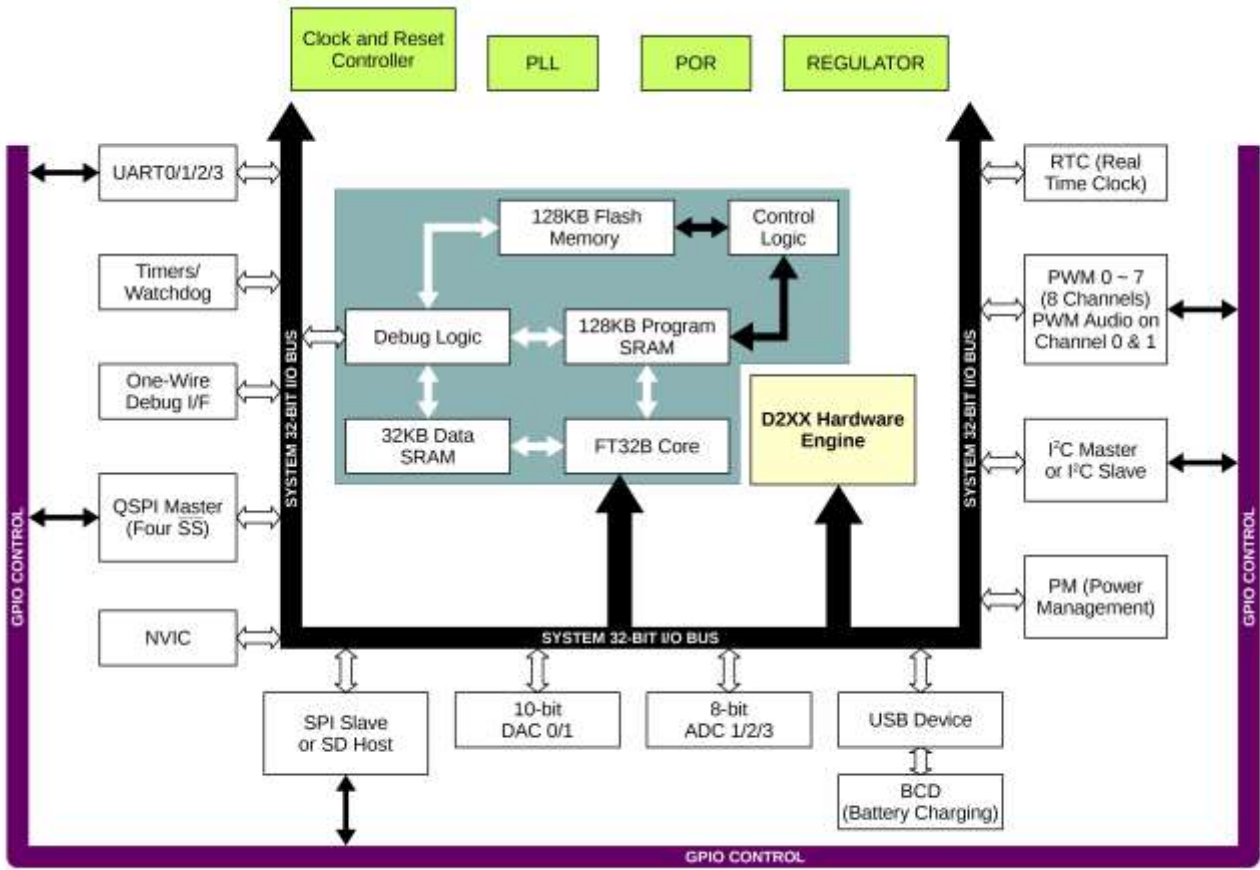

**Figure 2-1 FT930 68-pin Block Diagram**

For a description of each function please refer to Section 4.

## Table of Contents

<b>1</b>	<b>Typical Applications.....</b>	<b>2</b>
1.1	Part Numbers.....	2
1.2	Part Comparison Chart.....	3
1.3	USB2.0 Compliant .....	3
<b>2</b>	<b>FT930 Block Diagram .....</b>	<b>4</b>
<b>3</b>	<b>Device Pinout and Signal Description .....</b>	<b>8</b>
3.1	FT930 QFN68 Pinout .....	8
3.2	FT931 QFN56 Pinout .....	9
3.3	FT932 QFN48 Pinout .....	10
3.4	FT933 QFN48 Pinout .....	11
3.5	FT930 Pin Description.....	12
3.6	FT931 Pin Description.....	18
3.7	FT932 Pin Description.....	23
3.8	FT933 Pin Description.....	27
<b>4</b>	<b>Function Description .....</b>	<b>31</b>
4.1	Architectural Overview .....	31
4.2	FT32B Core Processor .....	31
4.3	D2XX Hardware Engine .....	31
4.4	128kB Flash Memory.....	32
4.5	Boot Sequence .....	32
4.6	Interrupt.....	32
4.7	Memory Mapping.....	33
4.8	USB2.0 Device Controller .....	34
4.8.1	Features .....	34
4.9	Real Time Clock .....	35
4.9.1	Features .....	35
4.10	One-Wire Debugger Interface .....	35
4.10.1	Features .....	35
4.11	SPI Interface.....	35
4.11.1	Features .....	35
4.12	I <sup>2</sup> C Interface .....	36
4.12.1	Features .....	36
4.13	UART Interface.....	36

---

4.13.1	Features .....	36
<b>4.14</b>	<b>Timers and Watchdog Timer.....</b>	<b>36</b>
4.14.1	Features .....	37
<b>4.15</b>	<b>PWM.....</b>	<b>37</b>
4.15.1	Features .....	37
<b>4.16</b>	<b>SD Host Controller.....</b>	<b>38</b>
4.16.1	Features .....	38
<b>4.17</b>	<b>Analog to Digital Converter (ADC).....</b>	<b>38</b>
4.17.1	Features .....	38
<b>4.18</b>	<b>Digital to Analog Converter (DAC).....</b>	<b>38</b>
4.18.1	Features .....	38
<b>4.19</b>	<b>General Purpose Input Output.....</b>	<b>39</b>
4.19.1	Features .....	39
<b>4.20</b>	<b>System Clocks .....</b>	<b>39</b>
4.20.1	12MHz Oscillator.....	39
4.20.2	Phase Locked Loop.....	39
4.20.3	32.768 kHz RTC Oscillator.....	39
4.20.4	Internal Slow Clock Oscillator .....	39
<b>4.21</b>	<b>Power Management.....</b>	<b>40</b>
4.21.1	Power Supply .....	40
4.21.2	Power down Mode .....	40
<b>5</b>	<b>Device Characteristics and Ratings.....</b>	<b>41</b>
<b>5.1</b>	<b>Absolute Maximum Ratings.....</b>	<b>41</b>
<b>5.2</b>	<b>DC Characteristics.....</b>	<b>42</b>
<b>5.3</b>	<b>AC Characteristics .....</b>	<b>44</b>
<b>5.4</b>	<b>8-bit ADC Converter .....</b>	<b>50</b>
<b>5.5</b>	<b>10-bit DAC Converter .....</b>	<b>50</b>
<b>6</b>	<b>Application Information .....</b>	<b>51</b>
<b>6.1</b>	<b>Crystal Oscillator .....</b>	<b>51</b>
6.1.1	Crystal oscillator application circuit.....	51
6.1.2	External clock input.....	51
<b>6.2</b>	<b>RTC Oscillator .....</b>	<b>52</b>
<b>6.3</b>	<b>Standard I/O Pin Configuration .....</b>	<b>52</b>
<b>6.4</b>	<b>USB2.0 Device Interface .....</b>	<b>53</b>
<b>6.5</b>	<b>USB Connection when Unused (FT93x).....</b>	<b>54</b>
<b>7</b>	<b>Package Parameters.....</b>	<b>55</b>

---

---

<b>7.1</b>	<b>QFN-68 Package Dimensions .....</b>	<b>56</b>
<b>7.2</b>	<b>QFN-56 Package Dimensions .....</b>	<b>57</b>
<b>7.3</b>	<b>QFN-48 Package Dimensions .....</b>	<b>58</b>
<b>7.4</b>	<b>QFN-68/56/48 Device Marking .....</b>	<b>59</b>
7.4.1	FT93XQ Top Side .....	59
<b>7.5</b>	<b>Solder Reflow Profile .....</b>	<b>60</b>
<b>8</b>	<b>Contact Information .....</b>	<b>61</b>
<b>Appendix A – References .....</b>		<b>62</b>
	Document References .....	62
	Acronyms and Abbreviations.....	62
<b>Appendix B - List of Figures and Tables .....</b>		<b>63</b>
	List of Figures .....	63
	List of Tables.....	64
<b>Appendix C - Revision History .....</b>		<b>65</b>

### 3 Device Pinout and Signal Description

#### 3.1 FT930 QFN68 Pinout

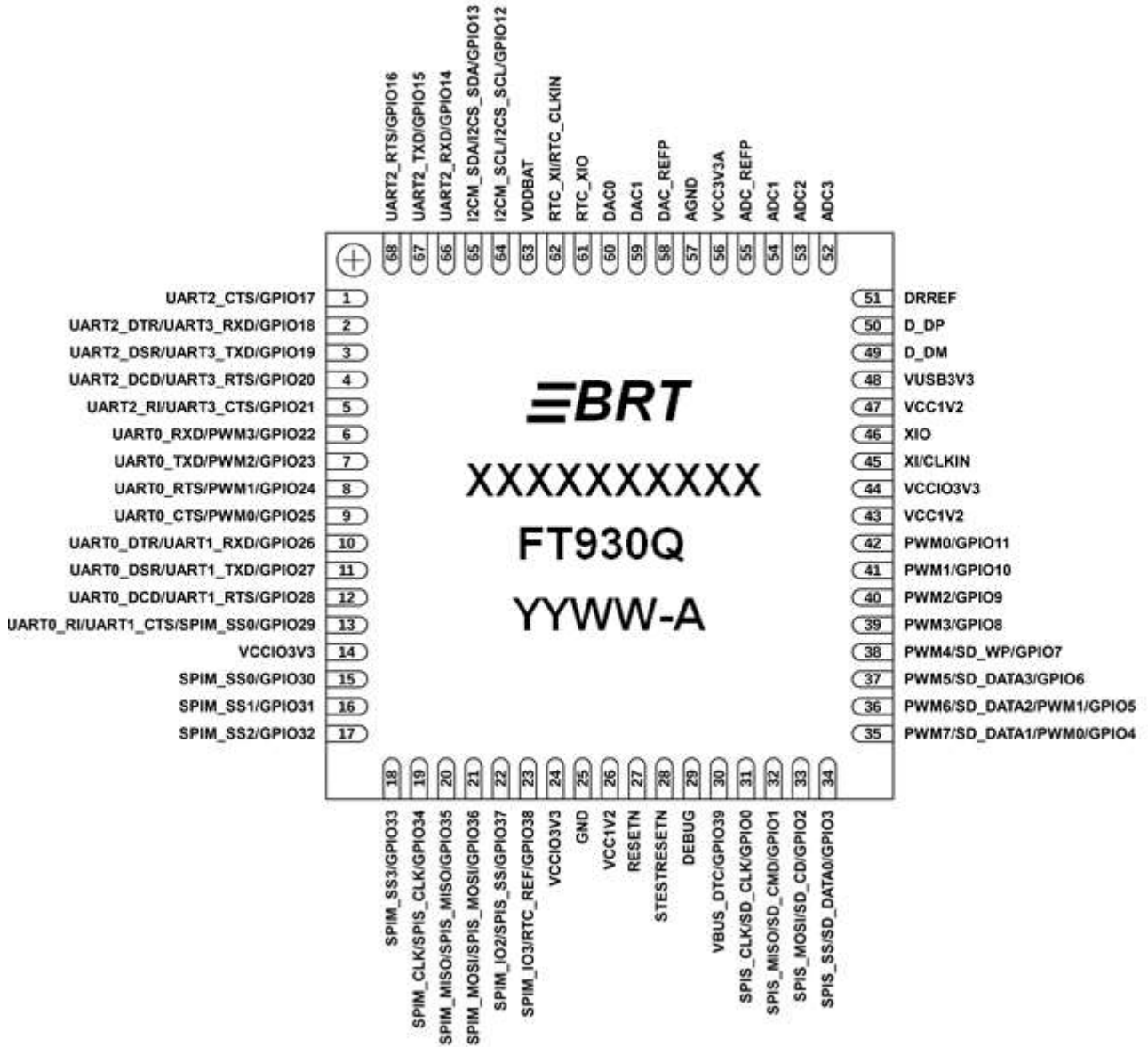

Figure 3-1 Pin Configuration FT930Q (top-down view)



### 3.2 FT931 QFN56 Pinout

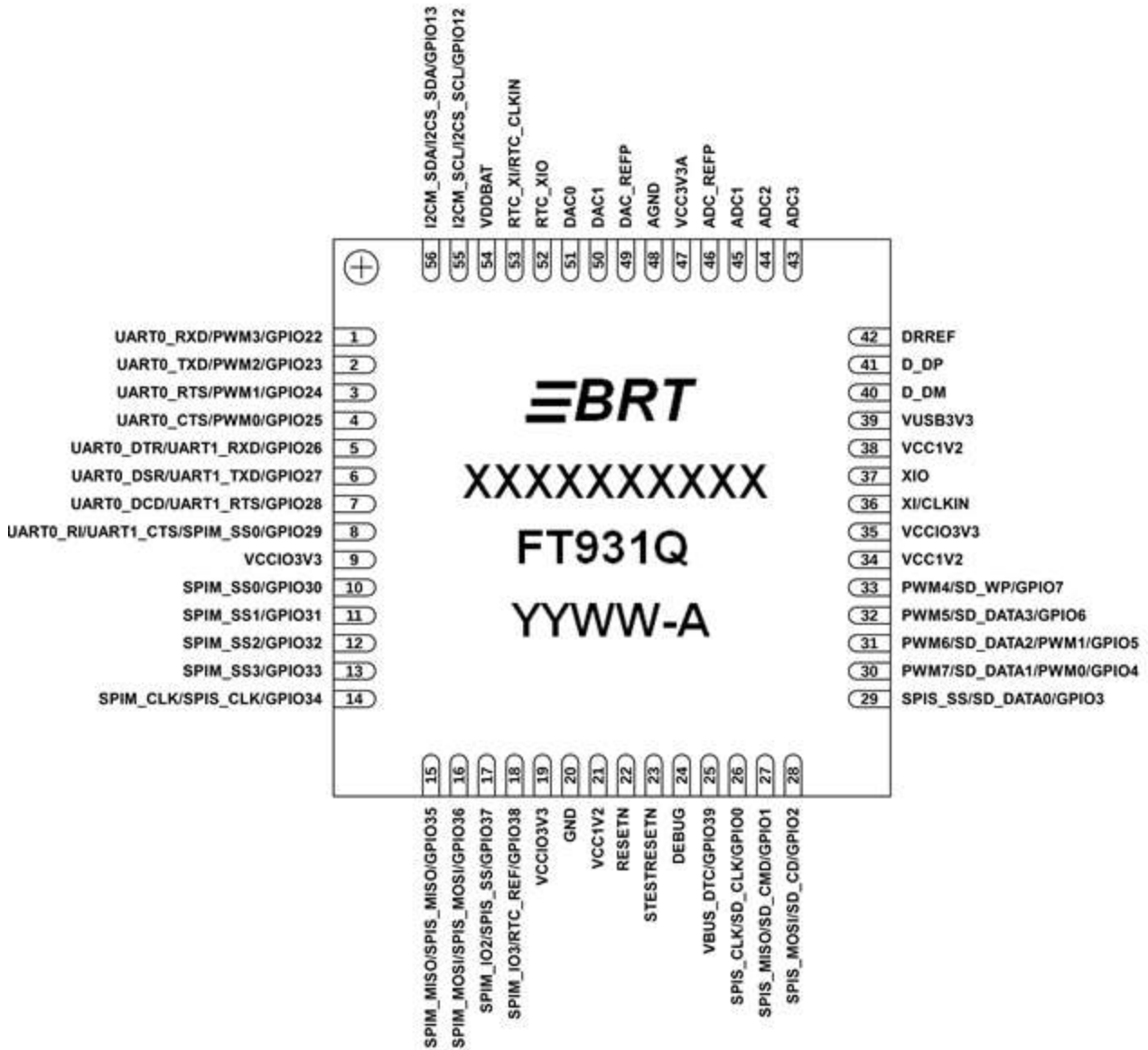

Figure 3-2 Pin Configuration FT931Q (top-down view)

### 3.3 FT932 QFN48 Pinout



Figure 3-3 Pin Configuration FT932Q (top-down view)

### 3.4 FT933 QFN48 Pinout



Figure 3-4 Pin Configuration FT933Q (top-down view)

### 3.5 FT930 Pin Description

Pin No.	Name	Type	Description
1	UART2_CTS/GPIO17	I/O	GPIO17 input/output. (By default is GPIO input, internal pull-low) Clear to send input for UART2.
2	UART2_DTR/UART3_RXD/ GPIO18	I/O	GPIO18 input/output. (By default is GPIO input, internal pull-low) Data terminal ready output for UART2. Receiver input for UART3.
3	UART2_DSR/UART3_TXD/ GPIO19	I/O	GPIO19 input/output. (By default is GPIO input, internal pull-low) Data set ready input for UART2 Transmitter output for UART3.
4	UART2_DCD/UART3_RTS/ GPIO20	I/O	GPIO20 input/output. (By default is GPIO input, internal pull-low) Data carrier detection input for UART2 Request to send output for UART3.
5	UART2_RI/UART3_CTS/ GPIO21	I/O	GPIO21 input/output. (By default is GPIO input, internal pull-low) Ring indicator input for UART2. Clear to send input for UART3.
6	UART0_RXD/PWM3/ GPIO22	I/O	GPIO22 input/output. (By default is GPIO input, internal pull-low) Receiver input for UART0. PWM channel 3, output.
7	UART0_TXD/PWM2/ GPIO23	I/O	GPIO23 input/output. (By default is GPIO input, internal pull-low) Transmitter output for UART0. PWM channel 2, output.
8	UART0_RTS/PWM1/ GPIO24	I/O	GPIO24 input/output. (By default is GPIO input, internal pull-low) Request to send output for UART0. PWM channel 1, output.
9	UART0_CTS/PWM0/ GPIO25	I/O	GPIO25 input/output. (By default is GPIO input, internal pull-low) Clear to send input for UART0. PWM channel 0, output.

Pin No.	Name	Type	Description
10	UART0_DTR/UART1_RXD/ GPIO26	I/O	GPIO26 input/output. (By default is GPIO input, internal pull-low) Data terminal ready output for UART0. Receiver input for UART1.
11	UART0_DSR/UART1_TXD/ GPIO27	I/O	GPIO27 input/output. (By default is GPIO input, internal pull-low) Data set ready input for UART0 Transmitter output for UART1.
12	UART0_DCD/UART1_RTS/ GPIO28	I/O	GPIO28 input/output. (By default is GPIO input, internal pull-low) Data carrier detection input for UART0. Request to send output for UART1.
13	UART0_RI/UART1_CTS/ SPIM_SS0/GPIO29	I/O	GPIO29 input/output. (By default is GPIO input, internal pull-low) Ring indicator input for UART0. Clear to send input for UART1. Slave select 0 output for SPI master.
14	VCCIO3V3	P	+3.3V supply voltage. This is the supply voltage for all the I/O ports. Connect a 0.1uF decoupling capacitor.
15	SPIM_SS0/GPIO30	I/O	GPIO30 input/output. (By default is GPIO input, internal pull-low) Slave select 0 output for SPI master.
16	SPIM_SS1/GPIO31	I/O	GPIO31 input/output. (By default is GPIO input, internal pull-low) Slave select 1 output for SPI master.
17	SPIM_SS2/GPIO32	I/O	GPIO32 input/output. (By default is GPIO input, internal pull-low) Slave select 2 output for SPI master.
18	SPIM_SS3/GPIO33	I/O	GPIO33 input/output. (By default is GPIO input, internal pull-low) Slave select 3 output for SPI master.
19	SPIM_CLK/SPIS_CLK/ GPIO34	I/O	GPIO34 input/output. (By default is GPIO input, internal pull-low) Serial clock output for SPI master. Serial clock input for SPI slave.

Pin No.	Name	Type	Description
20	SPIM_MISO/SPIS_MISO/ GPIO35	I/O	GPIO35 input/output. (By default is GPIO input, internal pull-low) Master in slave out for SPI master. Master in slave out for SPI slave.
21	SPIM_MOSI/SPIS_MOSI/ GPIO36	I/O	GPIO36 input/output. (By default is GPIO input, internal pull-low) Master out slave in for SPI master. Master out slave in for SPI slave.
22	SPIM_IO2/SPIS_SS/ GPIO37	I/O	GPIO37 input/output. (By default is GPIO input, internal pull-low) Data line 2 input/output for SPI master quad mode. Slave select input for SPI slave.
23	SPIM_IO3/RTC_REF/GPIO38	I/O	GPIO38 input/output. (By default is GPIO input, internal pull-low) Data line 3 input/output for SPI master quad mode. Reference clock for RTC calibration.
24	VCCIO3V3	P	+3.3V supply voltage. This is the supply voltage for all the I/O ports. Connect a 0.1uF decoupling capacitor.
25	GND	P	Ground.
26	VCC1V2	P	+1.2V core voltage.
27	RESETN	I	Chip reset input for normal operation. Active low. Connect external 10k pull-up to VCC3V3 for safe operation.
28	STESTRESETN	I	Chip reset input for test mode. Short to Ground for normal operation.
29	DEBUG	I/O	One-wire debugger interface input/output.
30	VBUS_DTC/GPIO39	I/O	GPIO39 input/output. (By default is GPIO input, internal pull-low) USB Device VBUS detection.
31	SPIS_CLK/SD_CLK/GPIO0	I/O	GPIO0 input/output. (By default is GPIO input, internal pull-low) Serial clock input for SPI slave. SD card serial clock output.

Pin No.	Name	Type	Description
32	SPIS_MISO/SD_CMD/GPIO1	I/O	GPIO1 input/output. (By default is GPIO input, internal pull-low) Master in slave out for SPI slave. SD card command signal input/output.
33	SPIS_MOSI/SD_CD/GPIO2	I/O	GPIO2 input/output. (By default is GPIO input, internal pull-low) SD card detect input.
34	SPIS_SS/SD_DATA0/GPIO3	I/O	GPIO3 input/output. (By default is GPIO input, internal pull-low) Slave select input for SPI slave. SD card data bus line 0 input/output.
35	PWM7/SD_DATA1/PWM0/ GPIO4	I/O	GPIO4 input/output. (By default is GPIO input, internal pull-low) PWM channel 7, output. SD card data bus line 1 input/output. PWM channel 0, output. A stereo 16/8-bit PCM audio data channel output.
36	PWM6/SD_DATA2/PWM1/ GPIO5	I/O	GPIO5 input/output. (By default is GPIO input, internal pull-low) PWM channel 6, output. SD card data bus line 2 input/output. PWM channel 1, output. A stereo 16/8-bit PCM audio data channel output.
37	PWM5/SD_DATA3/GPIO6	I/O	GPIO6 input/output. (By default is GPIO input, internal pull-low) PWM channel 5, output. SD card data bus line 3 input/output.
38	PWM4/SD_WP/GPIO7	I/O	GPIO7 input/output. (By default is GPIO input, internal pull-low) PWM channel 4, output. SD card write protection input.
39	PWM3/GPIO8	I/O	GPIO8 input/output. (By default is GPIO input, internal pull-low) PWM channel 3, output.
40	PWM2/GPIO9	I/O	GPIO9 input/output. (By default is GPIO input, internal pull-low) PWM channel 2, output.
41	PWM1/GPIO10	I/O	GPIO10 input/output. (By default is GPIO input, internal pull-low) PWM channel 1, output.

Pin No.	Name	Type	Description
42	PWM0/GPIO11	I/O	GPIO11 input/output. (By default is GPIO input, internal pull-low) PWM channel 0, output.
43	VCC1V2	P	+1.2V core voltage. This is internal regulator output and core voltage input. Connect 4.7uF and 0.1uF decoupling capacitors to GND.
44	VCCIO3V3	P	+3.3V supply voltage. This is the supply voltage for all the I/O ports. Connect a 0.1uF decoupling capacitor.
45	XI/CLKIN	AI	12MHz clock frequency. Input to the Oscillator circuit.
46	XIO	AI/O	Output from the Oscillator amplifier. Input to the internal clock generator circuit.
47	VCC1V2	P	+1.2V core voltage. This is internal regulator output and core voltage input. Connect 4.7uF and 0.1uF decoupling capacitors to GND.
48	VUSB3V3	P	+3.3V supply voltage. This is the supply voltage for USB Device I/O ports. Connect 10uF and 0.1uF decoupling capacitors. This pin can be connected to all +3.3V power supply pins without the 10uF capacitor.
49	D_DM	AI/O	USB Device bidirectional DM line.
50	D_DP	AI/O	USB Device bidirectional DP line.
51	DRREF	AI	USB Device reference voltage input. Connect 12k ohm +/- 1% resistor to GND.
52	ADC3	AI	8-bit A/D converter 3, input.
53	ADC2	AI	8-bit A/D converter 2, input.
54	ADC1	AI	8-bit A/D converter 1, input.
55	ADC_REFP	P	ADC positive reference voltage.
56	VCC3V3A	P	+3.3V supply voltage. This is the supply voltage for Analog I/O ports. Connect 10uF and 0.1uF decoupling capacitors. This pin can be connected to all VCC3V3 pins without the 10uF capacitor.
57	AGND	P	Analog Ground.
58	DAC_REFP	P	DAC positive reference voltage.



Pin No.	Name	Type	Description
59	DAC1	AO	10-bit D/A converter 1, output.
60	DAC0	AO	10-bit D/A converter 0, output.
61	RTC_XIO	AO	Output from the RTC Oscillator amplifier.
62	RTC_XI/RTC_CLKIN	AI	32.768KHz clock frequency input to the RTC Oscillator circuit or to internal RTC clock generator circuit.
63	VDDBAT	P	+1.5V real time clock supply voltage.
64	I2CM_SCL/I2CS_SCL/ GPIO12	I/O	GPIO12 input/output. (By default is GPIO input, internal pull-low) I2C master serial clock input/output. I2C slave serial clock input/output.
65	I2CM_SDA/I2CS_SDA/ GPIO13	I/O	GPIO13 input/output. (By default is GPIO input, internal pull-low) I2C master data line input/output. I2C slave data line input/output.
66	UART2_RXD/GPIO14	I/O	GPIO14 input/output. (By default is GPIO input, internal pull-low) Receiver input for UART2.
67	UART2_TXD/GPIO15	I/O	GPIO15 input/output. (By default is GPIO input, internal pull-low) Transmitter output for UART2.
68	UART2_RTS/GPIO16	I/O	GPIO16 input/output. (By default is GPIO input, internal pull-low) Request to send output for UART2.

**Table 3-1 FT930 Pin Description**

### 3.6 FT931 Pin Description

Pin No.	Name	Type	Description
1	UART0_RXD/PWM3/ GPIO22	I/O	GPIO22 input/output. (By default is GPIO input, internal pull-low) Receiver input for UART0. PWM channel 3, output.
2	UART0_TXD/PWM2/ GPIO23	I/O	GPIO23 input/output. (By default is GPIO input, internal pull-low) Transmitter output for UART0. PWM channel 2, output.
3	UART0_RTS/PWM1/ GPIO24	I/O	GPIO24 input/output. (By default is GPIO input, internal pull-low) Request to send output for UART0. PWM channel 1, output.
4	UART0_CTS/PWM0/ GPIO25	I/O	GPIO25 input/output. (By default is GPIO input, internal pull-low) Clear to send input for UART0. PWM channel 0, output.
5	UART0_DTR/UART1_RXD/ GPIO26	I/O	GPIO26 input/output. (By default is GPIO input, internal pull-low) Data terminal ready output for UART0. Receiver input for UART1.
6	UART0_DSR/UART1_TXD/ GPIO27	I/O	GPIO27 input/output. (By default is GPIO input, internal pull-low) Data set ready input for UART0 Transmitter output for UART1.
7	UART0_DCD/UART1_RTS/ GPIO28	I/O	GPIO28 input/output. (By default is GPIO input, internal pull-low) Data carrier detection input for UART0. Request to send output for UART1.
8	UART0_RI/UART1_CTS/ SPIM_SS0/GPIO29	I/O	GPIO29 input/output. (By default is GPIO input, internal pull-low) Ring indicator input for UART0. Clear to send input for UART1. Slave select 0 output for SPI master.
9	VCCIO3V3	P	+3.3V supply voltage. This is the supply voltage for all the I/O ports. Connect a 0.1uF decoupling capacitor.

Pin No.	Name	Type	Description
10	SPIM_SS0/GPIO30	I/O	GPIO30 input/output. (By default is GPIO input, internal pull-low) Slave select 0 output for SPI master.
11	SPIM_SS1/GPIO31	I/O	GPIO31 input/output. (By default is GPIO input, internal pull-low) Slave select 1 output for SPI master.
12	SPIM_SS2/GPIO32	I/O	GPIO32 input/output. (By default is GPIO input, internal pull-low) Slave select 2 output for SPI master.
13	SPIM_SS3/GPIO33	I/O	GPIO33 input/output. (By default is GPIO input, internal pull-low) Slave select 3 output for SPI master.
14	SPIM_CLK/SPIS_CLK/ GPIO34	I/O	GPIO34 input/output. (By default is GPIO input, internal pull-low) Serial clock output for SPI master. Serial clock input for SPI slave.
15	SPIM_MISO/SPIS_MISO/ GPIO35	I/O	GPIO35 input/output. (By default is GPIO input, internal pull-low) Master in slave out for SPI master. Master in slave out for SPI slave.
16	SPIM_MOSI/SPIS_MOSI/ GPIO36	I/O	GPIO36 input/output. (By default is GPIO input, internal pull-low) Master out slave in for SPI master. Master out slave in for SPI slave.
17	SPIM_IO2/SPIS_SS/ GPIO37	I/O	GPIO37 input/output. (By default is GPIO input, internal pull-low) Data line 2 input/output for SPI master quad mode. Slave select input for SPI slave.
18	SPIM_IO3/RTC_REF/GPIO38	I/O	GPIO38 input/output. (By default is GPIO input, internal pull-low) Data line 3 input/output for SPI master quad mode. Reference clock for RTC calibration.
19	VCCIO3V3	P	+3.3V supply voltage. This is the supply voltage for all the I/O ports. Connect a 0.1uF decoupling capacitor.
20	GND	P	Ground.
21	VCC1V2	P	+1.2V core voltage.

Pin No.	Name	Type	Description
22	RESETN	I	Chip reset input for normal operation. Active low. Connect external 10k pull-up to VCC3V3 for safe operation.
23	STESTRESETN	I	Chip reset input for test mode. Short to Ground for normal operation.
24	DEBUG	I/O	One-wire debugger interface input/output.
25	VBUS_DTC/GPIO39	I/O	GPIO39 input/output. (By default is GPIO input, internal pull-low) USB Device VBUS detection.
26	SPIS_CLK/SD_CLK/GPIO0	I/O	GPIO0 input/output. (By default is GPIO input, internal pull-low) Serial clock input for SPI slave. SD card serial clock output.
27	SPIS_MISO/SD_CMD/GPIO1	I/O	GPIO1 input/output. (By default is GPIO input, internal pull-low) Master in slave out for SPI slave. SD card command signal input/output.
28	SPIS_MOSI/SD_CD/GPIO2	I/O	GPIO2 input/output. (By default is GPIO input, internal pull-low) SD card detect input.
29	SPIS_SS/SD_DATA0/GPIO3	I/O	GPIO3 input/output. (By default is GPIO input, internal pull-low) Slave select input for SPI slave. SD card data bus line 0 input/output.
30	PWM7/SD_DATA1/PWM0/ GPIO4	I/O	GPIO4 input/output. (By default is GPIO input, internal pull-low) PWM channel 7, output. SD card data bus line 1 input/output. PWM channel 0, output. A stereo 16/8-bit PCM audio data channel output.
31	PWM6/SD_DATA2/PWM1/ GPIO5	I/O	GPIO5 input/output. (By default is GPIO input, internal pull-low) PWM channel 6, output. SD card data bus line 2 input/output. PWM channel 1, output. A stereo 16/8-bit PCM audio data channel output.
32	PWM5/SD_DATA3/GPIO6	I/O	GPIO6 input/output. (By default is GPIO input, internal pull-low) PWM channel 5, output.

Pin No.	Name	Type	Description
			SD card data bus line 3 input/output.
33	PWM4/SD_WP/GPIO7	I/O	GPIO7 input/output. (By default is GPIO input, internal pull-low) PWM channel 4, output. SD card write protection input.
34	VCC1V2	P	+1.2V core voltage. This is internal regulator output and core voltage input. Connect 4.7uF and 0.1uF decoupling capacitors to GND.
35	VCCIO3V3	P	+3.3V supply voltage. This is the supply voltage for all the I/O ports. Connect a 0.1uF decoupling capacitor.
36	XI/CLKIN	AI	12MHz clock frequency. Input to the Oscillator circuit.
37	XIO	AI/O	Output from the Oscillator amplifier. Input to the internal clock generator circuit.
38	VCC1V2	P	+1.2V core voltage. This is internal regulator output and core voltage input. Connect 4.7uF and 0.1uF decoupling capacitors to GND.
39	VUSB3V3	P	+3.3V supply voltage. This is the supply voltage for USB Device I/O ports. Connect 10uF and 0.1uF decoupling capacitors. This pin can be connected to all +3.3V power supply pins without the 10uF capacitor.
40	D_DM	AI/O	USB Device bidirectional DM line.
41	D_DP	AI/O	USB Device bidirectional DP line.
42	DRREF	AI	USB Device reference voltage input. Connect 12k ohm +/- 1% resistor to GND.
43	ADC3	AI	8-bit A/D converter 3, input.
44	ADC2	AI	8-bit A/D converter 2, input.
45	ADC1	AI	8-bit A/D converter 1, input.
46	ADC_REFP	P	ADC positive reference voltage.
47	VCC3V3A	P	+3.3V supply voltage. This is the supply voltage for Analog I/O ports. Connect 10uF and 0.1uF decoupling capacitors. This pin can be connected to all VCC3V3 pins without the 10uF capacitor.

Pin No.	Name	Type	Description
48	AGND	P	Analog Ground.
49	DAC_REFP	P	DAC positive reference voltage.
50	DAC1	AO	10-bit D/A converter 1, output.
51	DAC0	AO	10-bit D/A converter 0, output.
52	RTC_XIO	AO	Output from the RTC Oscillator amplifier.
53	RTC_XI/RTC_CLKIN	AI	32.768KHz clock frequency input to the RTC Oscillator circuit or to internal RTC clock generator circuit.
54	VDDBAT	P	+1.5V real time clock supply voltage.
55	I2CM_SCL/I2CS_SCL/ GPIO12	I/O	GPIO12 input/output. (By default is GPIO input, internal pull-low) I2C master serial clock input/output. I2C slave serial clock input/output.
56	I2CM_SDA/I2CS_SDA/ GPIO13	I/O	GPIO13 input/output. (By default is GPIO input, internal pull-low) I2C master data line input/output. I2C slave data line input/output.

**Table 3-2 FT931 Pin Description**

### 3.7 FT932 Pin Description

Pin No.	Name	Type	Description
1	UART0_RXD/PWM3/ GPIO22	I/O	GPIO22 input/output. (By default is GPIO input, internal pull-low) Receiver input for UART0. PWM channel 3, output.
2	UART0_TXD/PWM2/ GPIO23	I/O	GPIO23 input/output. (By default is GPIO input, internal pull-low) Transmitter output for UART0. PWM channel 2, output.
3	UART0_RTS/PWM1/ GPIO24	I/O	GPIO24 input/output. (By default is GPIO input, internal pull-low) Request to send output for UART0. PWM channel 1, output.
4	UART0_CTS/PWM0/ GPIO25	I/O	GPIO25 input/output. (By default is GPIO input, internal pull-low) Clear to send input for UART0. PWM channel 0, output.
5	UART0_DTR/UART1_RXD/ GPIO26	I/O	GPIO26 input/output. (By default is GPIO input, internal pull-low) Data terminal ready output for UART0. Receiver input for UART1.
6	UART0_DSR/UART1_TXD/ GPIO27	I/O	GPIO27 input/output. (By default is GPIO input, internal pull-low) Data set ready input for UART0 Transmitter output for UART1.
7	UART0_DCD/UART1_RTS/ GPIO28	I/O	GPIO28 input/output. (By default is GPIO input, internal pull-low) Data carrier detection input for UART0. Request to send output for UART1.
8	UART0_RI/UART1_CTS/ SPIM_SS0/GPIO29	I/O	GPIO29 input/output. (By default is GPIO input, internal pull-low) Ring indicator input for UART0. Clear to send input for UART1. Slave select 0 output for SPI master.
9	VCCIO3V3	P	+3.3V supply voltage. This is the supply voltage for all the I/O ports. Connect a 0.1uF decoupling capacitor.
10	GND	P	Ground.

Pin No.	Name	Type	Description
11	VCC1V2	P	+1.2V core voltage.
12	SPIM_CLK/SPIS_CLK/ GPIO34	I/O	GPIO34 input/output. (By default is GPIO input, internal pull-low) Serial clock output for SPI master. Serial clock input for SPI slave.
13	SPIM_MISO/SPIS_MISO/ GPIO35	I/O	GPIO35 input/output. (By default is GPIO input, internal pull-low) Master in slave out for SPI master. Master in slave out for SPI slave.
14	SPIM_MOSI/SPIS_MOSI/ GPIO36	I/O	GPIO36 input/output. (By default is GPIO input, internal pull-low) Master out slave in for SPI master. Master out slave in for SPI slave.
15	SPIM_IO2/SPIS_SS/ GPIO37	I/O	GPIO37 input/output. (By default is GPIO input, internal pull-low) Data line 2 input/output for SPI master quad mode. Slave select input for SPI slave.
16	SPIM_IO3/GPIO38	I/O	GPIO38 input/output. (By default is GPIO input, internal pull-low) Data line 3 input/output for SPI master quad mode.
17	RESETN	I	Chip reset input for normal operation. Active low. Connect external 10k pull-up to VCC3V3 for safe operation.
18	STESTRESETN	I	Chip reset input for test mode. Short to Ground for normal operation.
19	DEBUG	I/O	One-wire debugger interface input/output.
20	VBUS_DTC/GPIO39	I/O	GPIO39 input/output. (By default is GPIO input, internal pull-low) USB Device VBUS detection.
21	SPIS_CLK/SD_CLK/GPIO0	I/O	GPIO0 input/output. (By default is GPIO input, internal pull-low) Serial clock input for SPI slave. SD card serial clock output.
22	SPIS_MISO/SD_CMD/GPIO1	I/O	GPIO1 input/output. (By default is GPIO input, internal pull-low) Master in slave out for SPI slave. SD card command signal input/output.



Pin No.	Name	Type	Description
23	SPIS_MOSI/SD_CD/GPIO2	I/O	GPIO2 input/output. (By default is GPIO input, internal pull-low) SD card detect input.
24	SPIS_SS/SD_DATA0/GPIO3	I/O	GPIO3 input/output. (By default is GPIO input, internal pull-low) Slave select input for SPI slave. SD card data bus line 0 input/output.
25	PWM7/SD_DATA1/PWM0/ GPIO4	I/O	GPIO4 input/output. (By default is GPIO input, internal pull-low) PWM channel 7, output. SD card data bus line 1 input/output. PWM channel 0, output. A stereo 16/8-bit PCM audio data channel output.
26	PWM6/SD_DATA2/PWM1/ GPIO5	I/O	GPIO5 input/output. (By default is GPIO input, internal pull-low) PWM channel 6, output. SD card data bus line 2 input/output. PWM channel 1, output. A stereo 16/8-bit PCM audio data channel output.
27	PWM5/SD_DATA3/GPIO6	I/O	GPIO6 input/output. (By default is GPIO input, internal pull-low) PWM channel 5, output. SD card data bus line 3 input/output.
28	PWM4/SD_WP/GPIO7	I/O	GPIO7 input/output. (By default is GPIO input, internal pull-low) PWM channel 4, output. SD card write protection input.
29	VCC1V2	p	+1.2V core voltage. This is internal regulator output and core voltage input. Connect 4.7uF and 0.1uF decoupling capacitors to GND.
30	VCCIO3V3	P	+3.3V supply voltage. This is the supply voltage for all the I/O ports. Connect a 0.1uF decoupling capacitor.
31	XI/CLKIN	AI	12MHz clock frequency. Input to the Oscillator circuit.
32	XIO	AI/O	Output from the Oscillator amplifier. Input to the internal clock generator circuit.

Pin No.	Name	Type	Description
33	VCC1V2	P	+1.2V core voltage. This is internal regulator output and core voltage input. Connect 4.7uF and 0.1uF decoupling capacitors to GND.
34	VUSB3V3	P	+3.3V supply voltage. This is the supply voltage for USB Device I/O ports. Connect 10uF and 0.1uF decoupling capacitors. This pin can be connected to all +3.3V power supply pins without the 10uF capacitor.
35	D_DM	AI/O	USB Device bidirectional DM line.
36	D_DP	AI/O	USB Device bidirectional DP line.
37	DRREF	AI	USB Device reference voltage input. Connect 12k ohm +/- 1% resistor to GND.
38	ADC3	AI	8-bit A/D converter 3, input.
39	ADC2	AI	8-bit A/D converter 2, input.
40	ADC1	AI	8-bit A/D converter 1, input.
41	ADC_REFP	P	ADC positive reference voltage.
42	VCC3V3A	P	+3.3V supply voltage. This is the supply voltage for Analog I/O ports. Connect 10uF and 0.1uF decoupling capacitors. This pin can be connected to all VCC3V3 pins without the 10uF capacitor.
43	AGND	P	Analog Ground.
44	DAC_REFP	P	DAC positive reference voltage.
45	DAC1	AO	10-bit D/A converter 1, output.
46	DAC0	AO	10-bit D/A converter 0, output.
47	I2CM_SCL/I2CS_SCL/ GPIO12	I/O	GPIO12 input/output. (By default is GPIO input, internal pull-low) I2C master serial clock input/output. I2C slave serial clock input/output.
48	I2CM_SDA/I2CS_SDA/ GPIO13	I/O	GPIO13 input/output. (By default is GPIO input, internal pull-low) I2C master data line input/output. I2C slave data line input/output.

**Table 3-3 FT932 Pin Description**

### 3.8 FT933 Pin Description

Pin No.	Name	Type	Description
1	UART0_RXD/PWM3/ GPIO22	I/O	GPIO22 input/output. (By default is GPIO input, internal pull-low) Receiver input for UART0. PWM channel 3, output.
2	UART0_TXD/PWM2/ GPIO23	I/O	GPIO23 input/output. (By default is GPIO input, internal pull-low) Transmitter output for UART0. PWM channel 2, output.
3	UART0_RTS/PWM1/ GPIO24	I/O	GPIO24 input/output. (By default is GPIO input, internal pull-low) Request to send output for UART0. PWM channel 1, output.
4	UART0_CTS/PWM0/ GPIO25	I/O	GPIO25 input/output. (By default is GPIO input, internal pull-low) Clear to send input for UART0. PWM channel 0, output.
5	UART0_DTR/UART1_RXD/ GPIO26	I/O	GPIO26 input/output. (By default is GPIO input, internal pull-low) Data terminal ready output for UART0. Receiver input for UART1.
6	UART0_DSR/UART1_TXD/ GPIO27	I/O	GPIO27 input/output. (By default is GPIO input, internal pull-low) Data set ready input for UART0 Transmitter output for UART1.
7	UART0_DCD/UART1_RTS/ GPIO28	I/O	GPIO28 input/output. (By default is GPIO input, internal pull-low) Data carrier detection input for UART0. Request to send output for UART1.
8	UART0_RI/UART1_CTS/ SPIM_SS0/GPIO29	I/O	GPIO29 input/output. (By default is GPIO input, internal pull-low) Ring indicator input for UART0. Clear to send input for UART1. Slave select 0 output for SPI master.
9	VCCIO3V3	P	+3.3V supply voltage. This is the supply voltage for all the I/O ports. Connect a 0.1uF decoupling capacitor.
10	GND	P	Ground.

Pin No.	Name	Type	Description
11	VCC1V2	P	+1.2V core voltage.
12	SPIM_CLK/SPIS_CLK/ GPIO34	I/O	GPIO34 input/output. (By default is GPIO input, internal pull-low) Serial clock output for SPI master. Serial clock input for SPI slave.
13	SPIM_MISO/SPIS_MISO/ GPIO35	I/O	GPIO35 input/output. (By default is GPIO input, internal pull-low) Master in slave out for SPI master. Master in slave out for SPI slave.
14	SPIM_MOSI/SPIS_MOSI/ GPIO36	I/O	GPIO36 input/output. (By default is GPIO input, internal pull-low) Master out slave in for SPI master. Master out slave in for SPI slave.
15	SPIM_IO2/SPIS_SS/ GPIO37	I/O	GPIO37 input/output. (By default is GPIO input, internal pull-low) Data line 2 input/output for SPI master quad mode. Slave select input for SPI slave.
16	SPIM_IO3/GPIO38	I/O	GPIO38 input/output. (By default is GPIO input, internal pull-low) Data line 3 input/output for SPI master quad mode.
17	RESETN	I	Chip reset input for normal operation. Active low. Connect external 10k pull-up to VCC3V3 for safe operation.
18	STESTRESETN	I	Chip reset input for test mode. Short to Ground for normal operation.
19	DEBUG	I/O	One-wire debugger interface input/output.
20	VBUS_DTC/GPIO39	I/O	GPIO39 input/output. (By default is GPIO input, internal pull-low) USB Device VBUS detection.
21	NC	-	Not connected.
22	NC	-	Not connected.
23	NC	-	Not connected.
24	NC	-	Not connected.
25	NC	-	Not connected.
26	NC	-	Not connected.

Pin No.	Name	Type	Description
27	NC	-	Not connected.
28	NC	-	Not connected.
29	VCC1V2	P	+1.2V core voltage. This is internal regulator output and core voltage input. Connect 4.7uF and 0.1uF decoupling capacitors to GND.
30	VCCIO3V3	P	+3.3V supply voltage. This is the supply voltage for all the I/O ports. Connect a 0.1uF decoupling capacitor.
31	XI/CLKIN	AI	12MHz clock frequency. Input to the Oscillator circuit.
32	XIO	AI/O	Output from the Oscillator amplifier. Input to the internal clock generator circuit.
33	VCC1V2	P	+1.2V core voltage. This is internal regulator output and core voltage input. Connect 4.7uF and 0.1uF decoupling capacitors to GND.
34	VUSB3V3	P	+3.3V supply voltage. This is the supply voltage for USB Device I/O ports. Connect 10uF and 0.1uF decoupling capacitors. This pin can be connected to all +3.3V power supply pins without the 10uF capacitor.
35	D_DM	AI/O	USB Device bidirectional DM line.
36	D_DP	AI/O	USB Device bidirectional DP line.
37	DRREF	AI	USB Device reference voltage input. Connect 12k ohm +/- 1% resistor to GND.
38	ADC3	AI	8-bit A/D converter 3, input.
39	ADC2	AI	8-bit A/D converter 2, input.
40	NC	-	Not connected.
41	ADC_REFP	P	ADC positive reference voltage.
42	VCC3V3A	P	+3.3V supply voltage. This is the supply voltage for Analog I/O ports. Connect 10uF and 0.1uF decoupling capacitors. This pin can be connected to all VCC3V3 pins without the 10uF capacitor.
43	AGND	P	Analog Ground.
44	NC	-	Not connected.

Pin No.	Name	Type	Description
45	NC	-	Not connected.
46	NC	-	Not connected.
47	I2CM_SCL/I2CS_SCL/ GPIO12	I/O	GPIO12 input/output. (By default is GPIO input, internal pull-low) I2C master serial clock input/output. I2C slave serial clock input/output.
48	I2CM_SDA/I2CS_SDA/ GPIO13	I/O	GPIO13 input/output. (By default is GPIO input, internal pull-low) I2C master data line input/output. I2C slave data line input/output.

**Table 3-4 FT933 Pin Description**
**Notes:**

- P : Power or Ground
- I : Input
- O : Output
- OD : Open drain output
- I/O : Bi-direction Input and Output
- AI : Analog Input
- AO : Analog Output
- AI/O : Analog Input/output

## 4 Function Description

### 4.1 Architectural Overview

The FT93x series embedded microcontroller includes a high performance 32-bit FT32B RISC core processor and a D2XX hardware engine.

There is a 128KB high speed Flash memory for software program download with One-Wire debugger interface. The core processor uses a 32-bit I/O system bus to connect to all of the peripherals.

- 32-bit MCU Processor Core
- D2XX hardware engine
- 128kB Flash Memory
- 128kB Program Memory
- 32kB Data RAM
- USB2.0 Device Controller
  - Control Endpoint 0 (8B to 64B)
  - Data Endpoints 1 ~ 15 (8,128B)
- BCD (Battery Charging Detection)
- Real Time Clock
- One-Wire debugger interface
- One SPI Master interface
- One SPI Slave interface or SD Host Controller
- One I<sup>2</sup>C Master or one I<sup>2</sup>C Slave interface (3.4Mbps)
- Four programmable 8Mbit/s UARTs
- Four 16-bit timers and one 32-bit watchdog timer
- 8-Channel PWM with optional 2-Channel Audio PCM
- 10-bit two channel 1MS/s DAC
- 8-bit three channel 460KS/s ADC
- General purpose I/O interface

The functions for each controller / interface are briefly described in the following subsections.

### 4.2 FT32B Core Processor

The FT32B core processor runs at frequencies of up to 100MHz. The processor contains the CPU itself with control logic and its 128kB program memory and 32kB data memory. The outside connections for the core processor are the memory-mapped I/O interface, the interrupt interface, asynchronous reset, and the system clock.

### 4.3 D2XX Hardware Engine

The built-in D2XX hardware engine reduces the FT93x processor load of handling the USB protocol and software complexity. When the D2XX hardware engine is enabled and takes over the control of the USB Device interface, the FT93x enumerates as a multiple interface, bi-directional D2XX USB Device which is supported on most common platforms with a D2XX driver. The data transfer from the main processor to the USB is through the FT93x D2XX FIFO interface. It supports up to 7 FIFO channels, each corresponding to a D2XX interface.

Each channel has dedicated read and write pipes. There are a total of 14 pipes and 8,192B(8kB) of memory is reserved for the read and the write pipes. The maximum transfer size on a channel may be flexibly allocated as 2 to 4094 bytes across the D2XX FIFO interfaces 1 to 7.

## 4.4 128kB Flash Memory

The internal 128kB Flash memory is used to store a bootloader or user application for the FT93x series. It is a high performance and low power consumption memory that supports up to 80MHz serial clock. The system will perform memory copy from Flash memory to CPU program memory automatically after system power on.

## 4.5 Boot Sequence

After the initial memory copy completes, the CPU jumps to program memory location zero. This may be the start of the user’s application which is stored in advance in the flash memory, or a bootloader, which allows modification of the program memory via UART or USB as an example.

The option of a bootloader is a special purpose routine in the FT93x Series embedded microcontroller. It is a small routine stored in the flash memory. Typically, the bootloader is 1kB to 4kB in size, and resides at the top of the memory.

## 4.6 Interrupt

The FT93x interrupt controller handles 32 interrupt inputs. When an interrupt occurs, the Interrupt Service Route (ISR) will process this event via the CPU. The ISR vector range is from 0 to 31, which corresponds to interrupt 0 to 31. See Table 4-1 for further information.

Each interrupt shall be assigned the interrupt vector number and priority before use. By default, the highest priority interrupt is interrupt 0, and the lowest is interrupt 31. However, the interrupt priority can be rearranged by register settings and also allows multiple interrupts at the same priority.

To prevent the loss and delay of high priority interrupts, the FT93x series uses nested interrupts if enabled. Nested interrupts allow interrupt requests of a high priority to pre-empt interrupt requests of a lower priority. The FT93x series supports up to 16-levels deep nested interrupts.

The interrupt controller has a global interrupt mask bit to temporarily block all interrupts. If this bit is set to “1”, then with the exception of an interrupt assigned priority as “0”, which is a non-maskable interrupt (NMI) input, all interrupts are masked.

See Table 4-1 for the FT93x series default interrupt priority.

Peripherals of Interrupt	Interrupt Vector Index	Default Priority
Power Management	0	0 (NMI)
Reserved	1	1
USB2.0 Device Controller	2	2
Reserved	3	3
SD Host Controller	4	4
Mailbox Source	5	5
Mailbox Destination	6	6
UART 3	7	7
SPI Master	8	8
SPI Slave	9	9
Reserved	10	10



Peripherals of Interrupt	Interrupt Vector Index	Default Priority
I <sup>2</sup> C Master	11	11
I <sup>2</sup> C Slave	12	12
UART 0	13	13
UART 1	14	14
UART 2	15	15
PWM	16	16
Timers	17	17
GPIO	18	18
RTC	19	19
ADC	20	20
DAC	21	21
Slow Clock Timer	22	22
UNUSED	24-31	24-31

**Table 4-1 FT93x Series Default Interrupt Priority**

## 4.7 Memory Mapping

A list of the I/O memory mapping for registers and memory in the FT93x series is given below in Table 4-2. Refer to the [FT93x User Manual](#) for a detailed description of the registers.

Function	Address Memory Range		Comment
General Setup registers	0x10000	0x100FF	DW/W/B
Interrupt controller registers	0x10100	0x1013F	DW/W/B
USB2.0 Device Controller registers	0x10200	0x1031F	DW/W/B
RTC registers	0x10400	0x1043F	DW
SPI Master registers	0x10440	0x1047F	DW
SPI Slave registers	0x10480	0x104BF	DW
I <sup>2</sup> C Master registers	0x10500	0x1050F	B
I <sup>2</sup> C Slave registers	0x10510	0x1051F	B
UART 0 registers	0x10520	0x1052F	B
UART 1 registers	0x10530	0x1053F	B

Function	Address Memory Range		Comment
UART 2 registers	0x10540	0x1054F	B
UART 3 registers	0x10550	0x1055F	B
Timers (include Watchdog) registers	0x10560	0x1056F	B
PWM registers	0x105B0	0x105EF	Registers: B access FIFO: W access
SD Host Controller registers	0x10600	0x107FF	DW
Flash Controller registers	0x10800	0x108BF	B
Reserved	0x108C0	0x130FF	-

**Table 4-2 FT93x Series I/O Memory Mapping**

[Note] DW/W/B is the lengths of register operations.

DW: Double Word (32-bit)

W: Word (16-bit)

B: Byte (8-bit)

## 4.8 USB2.0 Device Controller

The USB 2.0 Device controller is fully compliant with the USB2.0 specification. There is also an option to enable a battery charger detection (BCD) feature on the upstream port, which can identify whether the connected downstream port supports SDP, CDP or DCP charging function. Battery charge detection allows the USB Device to determine if higher currents may be available from the USB connection for rapid battery charging.

When the D2XX hardware engine is enabled, the USB Device is under the controller of the D2XX hardware engine, the data transfer to USB from the FT93x is via a FIFO interface.

### 4.8.1 Features

- Supports data transfer at hi-speed (480 Mbit/s) and full-speed (12 Mbit/s).
- Software configurable EP0 control endpoint size 8-64 bytes.
- Software configurable 15 In/Out endpoints.
- EP1-EP15 has double buffering with 8,128B buffers.
- Supports Isochronous/Interrupt/Control/Bulk data transfers.
- Max endpoint packet sizes up to 1024 bytes.
- Supports VBUS detection.
- Supports suspend and resume power management functions.
- Supports remote wakeup feature.
- Supports Battery Charging specification revision 1.2.

---

## 4.9 Real Time Clock

The Real Time Clock (RTC) runs off a dedicated 32 kHz oscillator with its own power rail which can be connected to a separate battery.

### 4.9.1 Features

- Two clock sources, PCLK and CLK32KHZ
- Built-in Clock Stabilizer for CLK32KHZ
- Records system sleep time
- Supports Date and Time format in BCD
- Counts Second, Minute, Hour, Day, Date of the Month, Month and Year with Leap-Year Compensation Valid up to 2199
- Supports two configurable Time-of-Day Alarms
- Supports 1Hz and 32768Hz clock outputs
- Supports interrupt with 4 configurable events
- Supports Oscillator Stop Flag with both external trigger and internal auto detection
- Supports On-Chip Digital Trimming with Auto Calibration

## 4.10 One-Wire Debugger Interface

The Debugger interface provides the capability over a One-Wire half duplex serial link, to access memory mapped address space, such as the FT93x flash memory, program memory, data memory, and I/O memory. However, there is no transfer capability from any of the internal memory to the debugger interface.

### 4.10.1 Features

- Single wire half duplex link that has one Start, eight Data and one Stop bit at a 1M bit/s rate.
- Supports debugger command read / write operation with variable data transfer.
- Supports CHIP ID read out.
- Supports checksum check by Flash memory operation.
- Supports CPU software debugging to execute Run, Stop, Step, Halt, Set software breakpoint, etc. operations.
- Use semaphore flag to control resource allocated by CPU or Debugger.

## 4.11 SPI Interface

The FT93x series contains both SPI Master and SPI Slave controllers. SPI is a full duplex serial interface designed to handle multiple masters and slaves connected to a given bus.

### 4.11.1 Features

- Maximum SPI data bit rate 25MHz in master and slave modes.
- Full duplex synchronous serial data transfer.
- Compliant with SPI specification, supporting four transfer formats.
- SPI master supports Single, Dual, and Quad SPI transfer.
- SPI Slave support Single transfer only.
- Support SPI mode and FIFO mode operations.
- Multi-master system supported.
- Support bus error detection.
- SPI master can address up to 4 SPI slave devices.
- Support 64 Bytes receiver and 64 Bytes transmitter FIFO respectively.

---

## 4.12 I<sup>2</sup>C Interface

The FT93x series supports an I<sup>2</sup>C bus controller which is a bidirectional two wire interface. The two wires are Serial Clock line (SCL) and Serial Data line (SDA). The interface can be programmed to operate with arbitration and clock synchronization allowing it to operate in multi-master systems. The I<sup>2</sup>C interface supports transmission speeds up to 3.4Mb/s.

### 4.12.1 Features

- Conforms to v2.1 and v3.0 of the I<sup>2</sup>C specification.
- UM10204 I<sup>2</sup>C-bus specification and user manual Rev. 6 – 4 April 2014
- Support flexible transmission speed modes:
  - Standard (up to 100 kb/s)
  - Fast (up to 400 kb/s)
  - Fast-plus (up to 1 Mb/s)
  - High-speed (up to 3.4 Mb/s)
- The I<sup>2</sup>C interface can be configured to operate in Master mode or Slave mode.
- Perform arbitration and clock synchronization.
- Multi-master systems supported.
- Support both 7-bit and 10-bit addressing modes on the I<sup>2</sup>C bus.
- Support clock stretching.

## 4.13 UART Interface

The FT93x series contains four UART controllers with standard transmit and receive data lines. UART0 provides a full modem control handshake interface and support for 9-bit data, allowing automatic address detection while 9-bit data mode is enabled.

UART1 is a simplified programmable serial interface with CTS and RTS flow control logic. The signals are multiplexed with UART0 and can only be used if UART0 is used in simple mode (CTS/RTS only).

### 4.13.1 Features

- Maximum UART data bit rate of 8 Mbit/s.
- Two modes of operation : UART mode and FIFO mode
- 16 / 128 bytes FIFO for TX and RX in FIFO mode to reduce the interrupt frequency
- Software compatible with 16450, 16550, 16750 and 16950 UARTs
- MODEM control functions (CTS, RTS, DSR, DTR, RI and DCD)
- Programmable automatic out-of-band Flow Control logic through Auto-RTS and Auto-CTS
- Programmable automatic Flow Control logic using DTR and DSR
- Programmable automatic in-band Flow Control logic using XON / XOFF characters
- RS-485 buffer enable signals.
- Fully programmable serial interface characteristics:
  - 5-, 6-, 7-, 8- or 9-bit characters
  - Even, odd, or no-parity bit generation and detection
  - 1, 1.5, or 2 stop-bit generation
  - Baud generation
  - Detection of bad data in receive FIFO
- Support Transmitter and Receiver disable capability.

## 4.14 Timers and Watchdog Timer

The FT93x series has four 16-bit user timers with individual prescaler and a 32-bit watchdog feature.

The watchdog timer is controlled from the main clock. The watchdog can be initialized with a 5-bit register. The value of this register points to a bit of the 32-bit counter which will be set by the application firmware.

As the timer decrements, an interrupt occurs when the timer rolls over. Once started and initialized the watchdog can't be stopped. It can only be cleared by writing into a register.

The four user timers can be controlled from the main clock, each timer has its own 16-bit prescaler. These timers can be started, stopped and cleared / initialized. The prescalers can be cleared/initialised the same way.

The current value of all timers/prescalers can be read from a common register one-at-a-time (multiplexed access).

All timers can count up/down and signal an interrupt when the timer rolls over. The timers can also be configured to be one-shot or in continuous mode. They are initialised from a common register one-at-a-time (multiplexed access).

If the user timer has already started using its prescaler it cannot be cleared and the command is ignored. Each of the prescalers automatically stops after it is cleared individually. It also starts automatically when the corresponding user timer starts using it.

#### **4.14.1 Features**

- Four user timers with individual prescaler.
- Supports 16-bit prescaler with system clock reference.
- Supports individual timer interrupt generation.
- Supports one-shot and continuous count for timer.
- Supports 32-bit counter watchdog.
- Supports watchdog interrupt generation.

### **4.15 PWM**

The FT93x series supports 8 separate independent PWM output channels. All channels share an 8-bit prescaler to scale the system clock frequency to the desired channels.

Each channel has its own 16-bit comparator value. This is the value that would be matched to a preset 16-bit counter. When a channel's 16-bit comparator value matches that of the 16-bit counter, the corresponding PWM channel output will toggle. This 16-bit comparator value will continue to count until it reaches its preset value, and the counter will just roll over.

A special feature allows each of the 8 channels to toggle its own output based on the comparison results of the other channels. Hence each channel potentially can have up to 8 toggle edges.

The PWM signal generated can be output as either multi-single-shot or continuous.

PWM channel 0 and channel 1 can double as a stereo 11 KHz or 22 KHz PWM audio channel.

Once this feature is setup, the 16-bit or 8-bit PCM audio data can be downloaded to the PWM local FIFO which can hold up to 64 bytes stereo or 128 bytes mono audio data. The data will be played back based on the pre-scaler and 16-bit counter. The data will be automatically scaled to fit in the playback period if necessary.

The PWM FIFO can generate a number of interrupts for FIFO management. They are FIFO empty, full, half-full, overflow, and underflow.

Each of these interrupts can be individually masked if required.

#### **4.15.1 Features**

- Support 8 PWM output channels.
- Support multi-single-shot or continuous PWM data output.
- Support external GPIO trigger.
- Support 16-bit / 8-bit stereo PWM audio data output.
- Control PWM FIFO full, empty, half-empty, overflow and underflow buffer management.
- Support PCM volume control for audio playback.

---

## 4.16 SD Host Controller

The FT93x series contains one SD Host controller offering access to external large capacity non-volatile memory.

### 4.16.1 Features

- Compliant with SD Host controller standard specification, version 3.0.
- Supports both streaming and non-streaming data transfers.
- Compliant with SD physical layer specification, version 3.0.
- Supports configurable SD bus modes: 4-bit mode and 8-bit mode.
- Compliant with SDIO card specification, version 2.0.
- Support 4K SRAM for data FIFO.
- Supports configurable 1-bit/4-bit SD card bus.
- Configurable CPRM function for security.
- Built-in generation and check for 7-bit and 16-bit CRC data.
- Card detection (Insertion/Removal).
- Supports read wait mechanism for SDIO function.
- Supports suspend/resume mechanism for SDIO function.

## 4.17 Analog to Digital Converter (ADC)

The FT93x series has a low-power, high-speed, successive approximation Analog-to-Digital Converter (ADC) that supports 8-bit resolution and maximum sampling frequency up to 460kSPS.

This ADC accepts analog inputs ranging from the ground supply to the power supply. This ADC can be used in various low-power and medium-resolution applications.

### 4.17.1 Features

- 8-bit successive approximation ADC.
- Three-channel analog input ADC1/2/3.
- Individual channels can be selected for conversion.
- Power-down mode support.
- Maximum conversion rate of up to 460kSPS.
- Measurement range 0 to VCC3V3A, by default the range voltage is 10% off of VCC3V3A. See Table 5-7.
- INL: +/-1LSB (max).
- DNL: +/-1LSB (max).

## 4.18 Digital to Analog Converter (DAC)

The FT93x series has two 10-bit, 1 MSPS Digital-to-Analog converter (DAC). It includes digital logic for registering the DAC value and a unity-gain buffer capable of driving off-chip. The module can also be switched to a power-down state where it consumes a minimum amount of current.

### 4.18.1 Features

- Two 10-bit DACs (DAC0/1).
- 10-bit R2R DAC ladder structure.
- Buffered output.
- Power-down mode support.
- Programmable conversion rate, the maximum rate is 1MHz.
- Selectable output drive.
- INL: +/-1.5LSB (max).
- DNL: +/-1LSB (max).

## 4.19 General Purpose Input Output

The FT93x series provides up to 40 configurable Input/output pins controlled by GPIO registers. All pins have multiple functions with special peripheral connection. Separate registers allow setting or clearing any number of outputs simultaneously.

All GPIO pins default to inputs with pull-down resistors enabled on reset.

All GPIOs can function as an interrupt. The polarity can be either positive edge or negative edge if the interrupt capability is enabled. In this case, the GPIO pin must be configured as a GPIO input.

### 4.19.1 Features

- All GPIO default to inputs after reset.
- Multi-function selection on GPIO pins.
- Pull-up/Pull-down resistor configuration and open-drain configuration can be programmed through the pin connect block for each GPIO pin.
- Direction control of individual bits.
- Supports GPIO input Schmitt trigger to help remove noise.

Supports GPIO interrupt, where each enabled GPIO interrupt can be used to wake-up the system from power-down mode.

## 4.20 System Clocks

### 4.20.1 12MHz Oscillator

The oscillator generates a 12MHz reference frequency output to the clock multiplier PLL. The oscillator clock source comes from either an external 12MHz crystal or a 12MHz square wave clock. The external crystal is connected across XI/CLKIN and XIO in the configuration shown in Section 6.1. The optional external clock input is connected to XI only.

### 4.20.2 Phase Locked Loop

The internal PLL takes the 12MHz clock input from the crystal oscillator. The PLL outputs the 100MHz system clock frequency to the CPU processor and other peripheral circuits. Each peripheral has an individual enable control signal to gate the clock source.

### 4.20.3 32.768 kHz RTC Oscillator

The RTC oscillator provides a clock to the RTC time counter. An external 32.768 kHz crystal or a 32.768 kHz square wave signal can be used as the clock source.

The external crystal is connected across RTC\_XI/RTC\_CLKIN and RTC\_XIO in the configuration shown in Section 6.2. The optional external clock input is connected to RTC\_XI/RTC\_CLKIN only.

### 4.20.4 Internal Slow Clock Oscillator

The internal slow clock oscillator provides a 5ms slow clock source to generate an interrupt for the USB2.0 device remote wake-up feature.

A USB2.0 device with remote wake-up capability may not generate a resume signal unless the bus has been continuously in the idle state for 5ms. For detailed description of the USB2.0 resume/suspend, refer to [USB2.0 specification](#) Chapters 7.1.7.6 & 7.1.7.7.

## **4.21 Power Management**

### **4.21.1 Power Supply**

The FT93x series may be operated with a single supply of +3.3V applied to VCCIO3V3, VUSB3V3, and VCC3V3A pins. The +1.2V internal regulator provides power to the core circuit after VCCIO3V3 power is applied and the system will generate a Power on Reset (POR) pulse when the output voltage rises above the POR threshold.

### **4.21.2 Power down Mode**

Power down mode applies to the entire system. In the power down mode, the system 12MHz oscillator and PLL both switch off and the system clock to the core and all peripherals stop except for the RTC oscillator and internal regulator. The internal regulator retains power for the core and RTC operation.

An interrupt from GPIO or wake-up events from the USB2.0 Device controller can wake-up the system from the power down mode independently.

If the USB2.0 Device controller was used and the respective interrupt bit was also enabled before the system entered into power down mode, then the following events can wake-up the system.

- USB2.0 Device controller detects connects interrupt.
- USB2.0 Device controller detects disconnects interrupt.
- USB Host issue reset signal to the USB2.0 Device controller.
- USB Host issue resume signal to the USB2.0 Device controller.



## 5 Device Characteristics and Ratings

### 5.1 Absolute Maximum Ratings

The absolute maximum ratings for the FT93x series devices are as follows. These are in accordance with the Absolute Maximum Rating System (IEC 60134). Exceeding these may cause permanent damage to the device.

Parameter	Value	Unit
Storage Temperature	-65 to +150	°C
Floor Life (Out of Bag) At Factory Ambient (30°C / 60% Relative Humidity)	168 Hours (IPC/JEDEC J-STD-033A MSL Level 3 Compliant)*	Hours
Ambient Temperature (Power Applied)	-40 to +85	°C
VCC3V3 Supply Voltage	-0.5 to +4.6	V
DC Input Voltage: USB Device D_DP and D_DM	-0.5 to +5	V
DC Input Voltage: 5V tolerant I/O cells	-0.5 to +5.8	V
Others (ADC, DAC) – 3V I/O cells	-0.5 to VCC3V3+0.5	V

**Table 5-1 Absolute Maximum Ratings**

\* If devices are stored out of the packaging beyond this time limit, the devices should be baked before use. The devices should be ramped up to a temperature of +125°C and baked for up to 17 hours.

## 5.2 DC Characteristics

**Electrical Characteristics** (Ambient Temperature = -40°C to +85°C)

The typical values are obtained at room temperature ( $T_j = 25^\circ\text{C}$ ),  $V_{CC3V3} = 3.3\text{V}$ , and  $V_{CC1V2} = 1.2\text{V}$ .

Parameter	Description	Minimum	Typical	Maximum	Units	Conditions
VCCIO3V3	I/O operating supply voltage	2.97	3.3	3.63	V	Normal Operation
I <sub>cc1</sub>	Power down current	-	780	-	uA	Power Down Mode
I <sub>cc2</sub>	Idle current	-	43	-	mA	Idle
I <sub>cc3</sub>	System operating current*	-	75	-	mA	USB2.0 Device controller high speed transfer data
		-	48	-	mA	ADC / DAC Operation
I <sub>OL/OH</sub>	High level/Low level total maximum output current	-	-	96	mA	For all GPIOs
VCC1V2	Internal LDO voltage	-	1.2	-	V	Normal Operation

**Table 5-2 Operating Voltage and Current**

Note\*: The system operating typical current measured based on each function implements normal operation with FT32B core active, and other peripherals keep idle status.

### DC characteristics of I/O cells

Parameter	Description	Minimum	Typical	Maximum	Units	Conditions
V <sub>oh</sub>	Output Voltage High	2.4	-	-	V	I <sub>oh</sub>   = 2mA~16mA
V <sub>ol</sub>	Output Voltage Low	-	-	0.4	V	I <sub>ol</sub>   = 2mA~16mA
V <sub>opu</sub> *	Output pull-up Voltage for 5V tolerance I/Os	VCCIO3V3-0.9	-	-	V	I <sub>pu</sub>   = 1uA
V <sub>ih</sub>	Input High Voltage	2.0	-	-	V	LVTTTL
V <sub>il</sub>	Input Low Voltage	-	-	0.8	V	LVTTTL
V <sub>th</sub>	Schmitt trigger positive threshold Voltage	-	1.6	2.0	V	LVTTTL

Parameter	Description	Minimum	Typical	Maximum	Units	Conditions
$V_{tl}$	Schmitt-trigger negative threshold Voltage	0.8	1.1	-	V	LVTTTL
$R_{pu}$	Input pull-up resistance equivalent	40	75	190	K $\Omega$	$V_{in} = 0V$
$R_{pd}$	Input pull-down resistance equivalent	40	75	190	K $\Omega$	$V_{in} = V_{CCIO3V3}$
$I_{in}$	Input leakage current	-10	$\pm 1$	+10	$\mu A$	$V_{in} = V_{CCIO3V3}$ or 0
$C_{in}^*$	Input Capacitance	-	2.8	-	pF	VCCIO3V3 with 5V tolerance I/O

**Table 5-3 Digital I/O Pin Characteristics (VCCIO3V3 = +3.3V, Standard Drive Level)**

**Note\*:** This parameter indicates that the pull-up resistor for the 5V tolerance I/O cells cannot reach VCCIO3V3 DC level even without DC loading current.

$C_{in}$  includes the cell layout capacitance and pad capacitance.

**DC characteristics of USB I/O cells**

Parameter	Description	Minimum	Typical	Maximum	Units	Conditions
<b>General characteristics</b>						
VUSB3V3	USB power supply voltage	2.97	3.3	3.63	V	Normal operation
<b>Input level for high speed</b>						
$V_{hscm}$	Voltage of high speed data signal in the common mode	-50	-	500	mV	-
$V_{hssq}$	High speed squelch detection threshold	-	-	100	mV	Squelch is detected
		150	-	-	mV	Squelch is not detected
$V_{hdsdc}$	High speed disconnection detection threshold	625	-	-	mV	Disconnection is detected
		-	-	525	mV	Disconnection is not detected
<b>Output level for high speed</b>						
$V_{hsoi}$	High speed idle output voltage (Differential)	-10	-	10	mV	-
$V_{hsol}$	High speed low level output voltage (Differential)	-10	-	10	mV	-
$V_{hsoh}$	High speed high level output voltage (Differential)	-360	-	400	mV	-

Parameter	Description	Minimum	Typical	Maximum	Units	Conditions
V <sub>chirpj</sub>	Chirp-J output voltage (Differential)	700	-	1100	mV	-
V <sub>chirpk</sub>	Chirp-K output voltage (Differential)	-900	-	-500	mV	-
<b>Input level for full speed and low speed</b>						
V <sub>di</sub>	Differential input voltage sensitivity	0.2	-	-	V	V <sub>dp</sub> -V <sub>dm</sub>
V <sub>cm</sub>	Differential common mode voltage	0.8	-	2.5	V	-
V <sub>se</sub>	Single ended receiver threshold	0.8	-	2.0	V	-
<b>Output level for full speed and low speed</b>						
V <sub>ol</sub>	Low level output voltage	0	-	0.3	V	-
V <sub>oh</sub>	High level output voltage	2.8	-	3.6	V	-
<b>Resistance</b>						
R <sub>drv</sub>	Driver output impedance	40.5	45	49.5	ohm	Equivalent resistance used as an internal chip

**Table 5-4 USB I/O Pin (D\_DP/D\_DM) Characteristics**

### 5.3 AC Characteristics

AC Characteristics (Ambient Temperature = -40°C to +85°C)

#### System clock dynamic characteristics

Parameter	Value			Unit
	Minimum	Typical	Maximum	
<b>Crystal oscillator</b>				
Clock frequency	-	12.00	-	MHz
<b>External clock input</b>				
External clock jitter	-	-	500	ps
Clock duty cycle	45	50	55	%
Input voltage on pin XI/CLKIN	-	3.3	-	V

**Table 5-5 System clock characteristics**

**Note:** Recommended accuracy of the clock frequency is 50ppm for the crystal.

**RTC clock dynamic characteristics**

Parameter	Value			Unit
	Minimum	Typical	Maximum	
<b>Crystal oscillator</b>				
Clock frequency	-	32768	-	Hz
<b>External clock input</b>				
External clock jitter	-	-	500	ps
Clock duty cycle	45	50	55	%
Startup time	-	0.5	5	s
Input voltage on pin RTC_XI/RTC_CLKIN	-	1.2	-	V

**Table 5-6 RTC clock characteristics**

**Analog USB I/O pins dynamic characteristics**

Parameter	Description	Minimum	Typical	Maximum	Units	Conditions
<b>Driver characteristic for high speed</b>						
$T_{hsr}$	High speed differential rise time	500	-	-	ps	-
$T_{hsf}$	High speed differential fall time	500	-	-	ps	-
<b>Driver characteristic for full speed</b>						
$T_{fr}$	Rise time of DP/DM	4	-	20	ns	Cl=50pF 10%~90% of  Voh-Vol
$T_{ff}$	Fall time of DP/DM	4	-	20	ns	Cl=50pF 10%~90% of  Voh-Vol
$T_{frma}$	Differential rise/fall time matching	90	-	110	%	The first transition exclude from the idle mode
<b>Driver characteristic for low speed</b>						
$T_{lr}$	Rise time of DP/DM	75	-	300	ns	Cl=200pF~600pF 10%~90% of  Voh-Vol
$T_{lf}$	Fall time of DP/DM	75	-	300	ns	Cl=200pF~600pF 10%~90% of  Voh-Vol

Parameter	Description	Minimum	Typical	Maximum	Units	Conditions
$T_{Irma}$	Differential rise/fall time matching	80	-	120	%	The first transition exclude from the idle mode

**Table 5-7 Analog I/O pins (D\_DP/D\_DM, H\_DP/H\_DM) characteristics**

**Figure 5-1 USB Rise and Fall Times for DP/DM**

**I<sup>2</sup>C Bus I/O pins dynamic characteristics (V<sub>cc</sub> (I/O) = 3.3V)**

Parameter	Description	Standard mode (SM)		Fast mode (FM)		Fast mode Plus (FM+)		High Speed mode (HS)		Unit
		Min	Max	Min	Max	Min	Max	Min	Max	
F <sub>SCL</sub>	SCL clock frequency	0	100	0	400	0	1000	0	3400	kHz
T <sub>SCLL</sub>	SCL clock low period	4.7	-	1.3	-	0.5	-	0.320	-	μs
T <sub>SCLH</sub>	SCL clock high period	4.0	-	0.6	-	0.26	-	0.120	-	μs
T <sub>SU</sub>	Data setup time	250	-	100	-	50	-	10	-	ns
T <sub>HD</sub>	Data hold time	0	-	0	-	0	-	0	150	ns
T <sub>r</sub>	Rise time	-	1000	-	300	-	120	20	160	ns
T <sub>rCL1</sub>	Rise time 1 <sup>st</sup> clock after S <sub>r</sub> and after ack (HS)							20	160	ns
T <sub>rCL</sub>	Rise time clock (HS)							20	80	ns
T <sub>f</sub>	Fall time	-	300	-	300	-	120	20	80 (SCL) 160 (SDA)	ns

**Table 5-8 I2C I/O pins (I2C0\_SCL/SDA, I2C1\_SCL/SDA) characteristics**



**Figure 5-2 Definition of I<sup>2</sup>C Timing F/S mode**

**Figure 5-3 Definition of I<sup>2</sup>C Timing HS mode**
**SPI Master I/O pins dynamic characteristics (V<sub>CC</sub> (I/O) = 3.3V)**

Parameter	Description	V <sub>CC</sub> (I/O) 3.3V			Unit
		Minimum	Typical	Maximum	
T <sub>SCLK</sub>	SPI clock period	25			ns
T <sub>SCLKL</sub>	SPI clock low duration	19			ns
T <sub>SCLKH</sub>	SPI clock high duration	19			ns
T <sub>OD</sub>	output data delay	19		20	ns

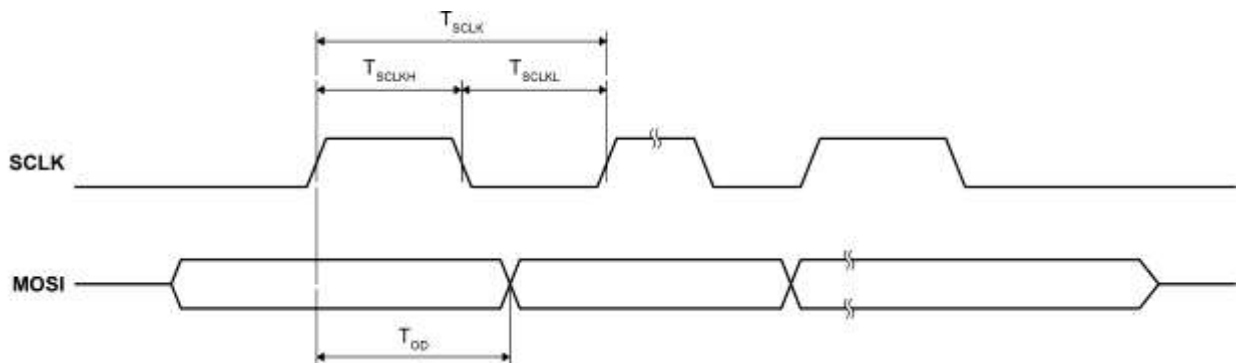
**Table 5-9 SPI I/O pins (SPIM\_CLK/MOSI/MISO/SS0/SS1/SS2/SS3) characteristics**

**Figure 5-4 Definition of SPI Master Timing Mode 0**



**SPI Slave I/O pins dynamic characteristics ( $V_{cc} (I/O) = 3.3V$ )**

Parameter	Description	$V_{cc} (I/O) 3.3V$			Unit
		Min	Typ	Max	
$T_{SCLK}$	SPI clock period	40			ns
$T_{SCLKL}$	SPI clock low duration	16			ns
$T_{SCLKH}$	SPI clock high duration	16			ns
$T_{SAC}$	SPI access time	20			ns
$T_{OD}$	output data delay	7		27	ns
$T_{ZO}$	output enable delay	10			ns
$T_{OZ}$	output disable delay	10			ns
$T_{CSH}$	CS hold time	0			ns

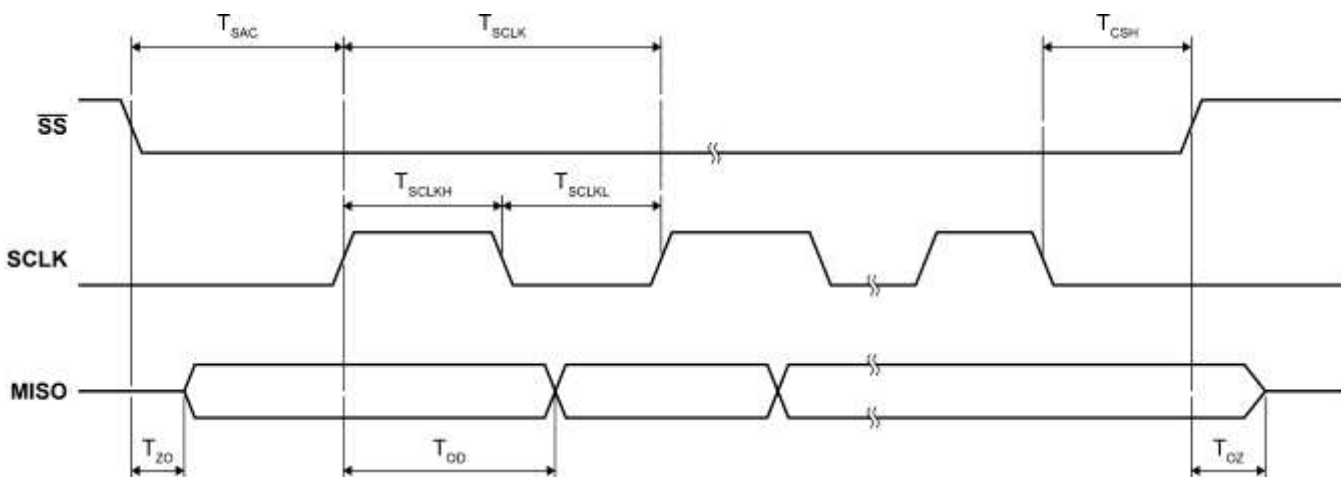
**Table 5-10 SPI I/O pins (SPIS0\_CLK/MOSI/MISO/SS, SPIS1\_CLK/MOSI/MISO/SS) characteristics**



**Figure 5-5 Definition of SPI Slave Timing Mode 0**

## 5.4 8-bit ADC Converter

### Electrical characteristics of ADC I/O cells

Electrical Characteristics (Ambient Temperature = -40°C to +85°C). The typical values are obtained at room temperature ( $T_j = 25^\circ\text{C}$ ),  $V_{CC3V3} = 3.3\text{V}$ , and  $V_{CC1V2} = 1.2\text{V}$ .

Parameter	Description	Minimum	Typical	Maximum	Units	Conditions
VCC3V3A	Analog power supply voltage	2.97	3.3	3.63	V	Normal operation
XAIN	Analog input range	0	-	VCC3V3A	V	-
RES	Resolution	-	8	-	Bit	-
INL	Integral nonlinearity error	-1	-	1	LSB	Rail-to-Rail VCC3V3A reference
DNL	Differential nonlinearity error	-1	-	1	LSB	Rail-to-Rail VCC3V3A reference
Xsampleclk	Sample rate	-	-	480	kSPS	-

**Table 5-11 ADC Characteristics**

## 5.5 10-bit DAC Converter

### Electrical characteristics of DAC I/O cells

Electrical Characteristics (Ambient Temperature = -40°C to +85°C). The typical values are obtained at room temperature ( $T_j = 25^\circ\text{C}$ ),  $V_{CC3V3} = 3.3\text{V}$ , and  $V_{CC1V2} = 1.2\text{V}$ .

Parameter	Description	Minimum	Typical	Maximum	Units	Conditions
VCC3V3A	DAC power supply voltage	2.97	3.3	3.63	V	Normal Operation
VREFP	Reference voltage	0	-	VCC3V3A	V	DAC_VREFP positive reference
RES	Resolution	-	10	-	Bits	-
INL	Integral nonlinearity error	-1.5	-	1.5	LSB	VREFP = 3.2V code 8 ~ 1023
DNL	Differential nonlinearity error	-1	-	1	LSB	VREFP = 3.2V code 0 ~ 1023
-	Conversion latency	-	-	1	Clock cycle	-
C <sub>LOAD</sub>	Output load: rated capacitance	-	-	10	pF	-
R <sub>LOAD</sub>	Output load: rated resistance	6.7	-	-	KΩ	-

**Table 5-12 DAC Characteristics**

## 6 Application Information

### 6.1 Crystal Oscillator

The crystal oscillator operates at a frequency of 12MHz. The oscillator can operate in one of two following configurations.

#### 6.1.1 Crystal oscillator application circuit



Figure 6-1 Crystal Oscillator Connection

Feedback resistance is integrated on chip; only a crystal and capacitors  $C_L$  need to be connected externally. With the proper selection of crystal, the oscillator circuit can generate a good quality signal for the FT93x. Parameter  $C_L$  is typically 12pF but should be checked with the crystal manufacturer.

#### 6.1.2 External clock input



Figure 6-2 External clock input

The 12MHz input clock signal connects XI to internal oscillator directly. The XIO pin can be left unconnected.

## 6.2 RTC Oscillator

In the RTC oscillator circuit Figure 6-3, only a 32.768 KHz crystal and capacitors  $C_{RTCL}$  need to be connected externally. The parameter  $C_{RTCL}$  should be checked with the crystal manufacturer.

An external input clock Figure 6-4 can be connected to RTC\_XI/RTC\_CLKIN if RTC\_XIO is left open.

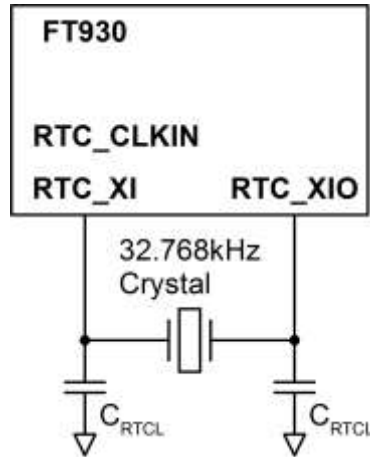

Figure 6-3 RTC 32.768 KHz Oscillator Connection

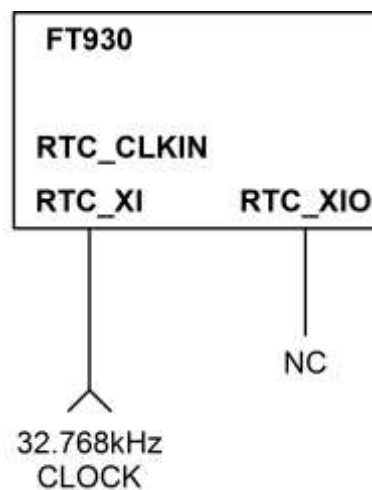

Figure 6-4 External 32.768 KHz Clock Input

## 6.3 Standard I/O Pin Configuration

Figure 6-5 shows the possible pin modes for standard I/O pins with multiplex functions:

- Output driver enabled
- Output driver capability control
- Output slew rate control
- Open drain output
- Input with pull-up enabled
- Input with pull-down enabled
- Input with keeper enabled
- Input with Schmitt trigger

The default configuration for standard I/O pins is input with pull-down enabled. All I/O pins have ESD protection.



**Figure 6-5 GPIO I/O Port Connection**

## 6.4 USB2.0 Device Interface

The example diagram in Figure 6-6 shows the FT93x series supporting one USB2.0 device port which makes FT93x system data transfer easier via a USB adapter.

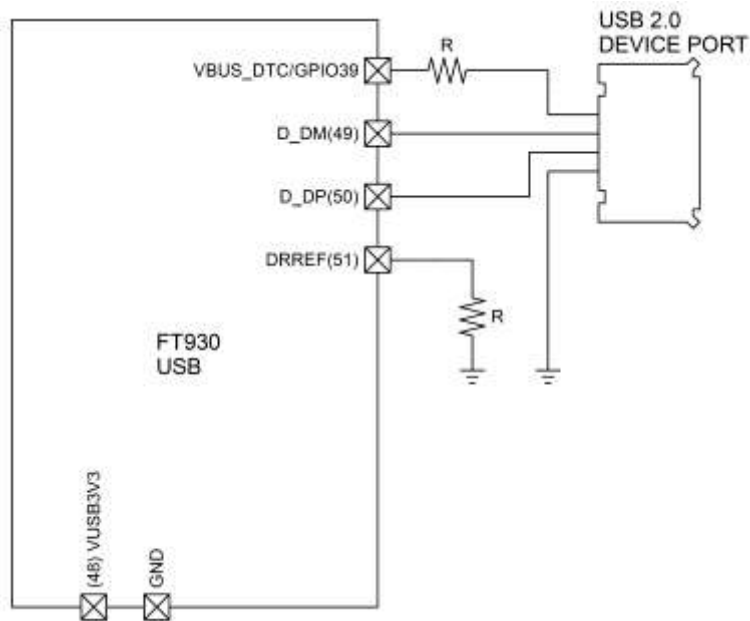

**Figure 6-6 USB2.0 Port Connection**

The FT93x system shall provide I/O power (+3.3V supply) on VUSB3V3.

The internal band-gap gets a reference voltage from DRREF with an external reference resistor R (12KΩ ±1%) connected to GND.

## 6.5 USB Connection when Unused (FT93x)

If the USB Device is not used in the end application, connect VUSB3V3 and DRREF to ground. See Figure 6-10 and Figure 6-11.

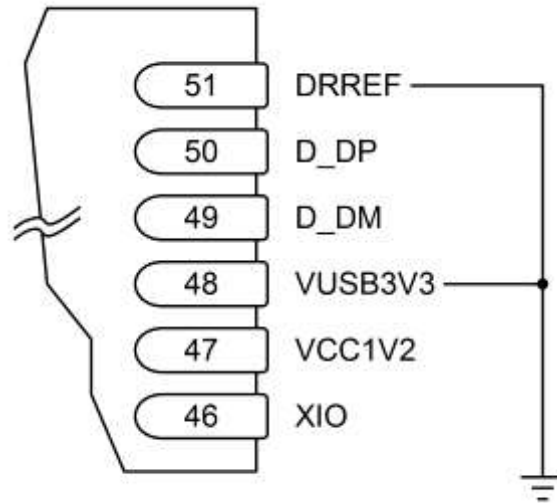

**Figure 6-7 Unused USB Connection (QFN)**

## 7 Package Parameters

The FT93x series is available in three different packages:

- FT930Q uses QFN-68 package.
- FT931Q uses QFN-56 package.
- FT932Q and FT933Q use QFN-48 package.

The dimensions, markings and solder reflow profile for all packages are described in following sections.

## 7.1 QFN-68 Package Dimensions

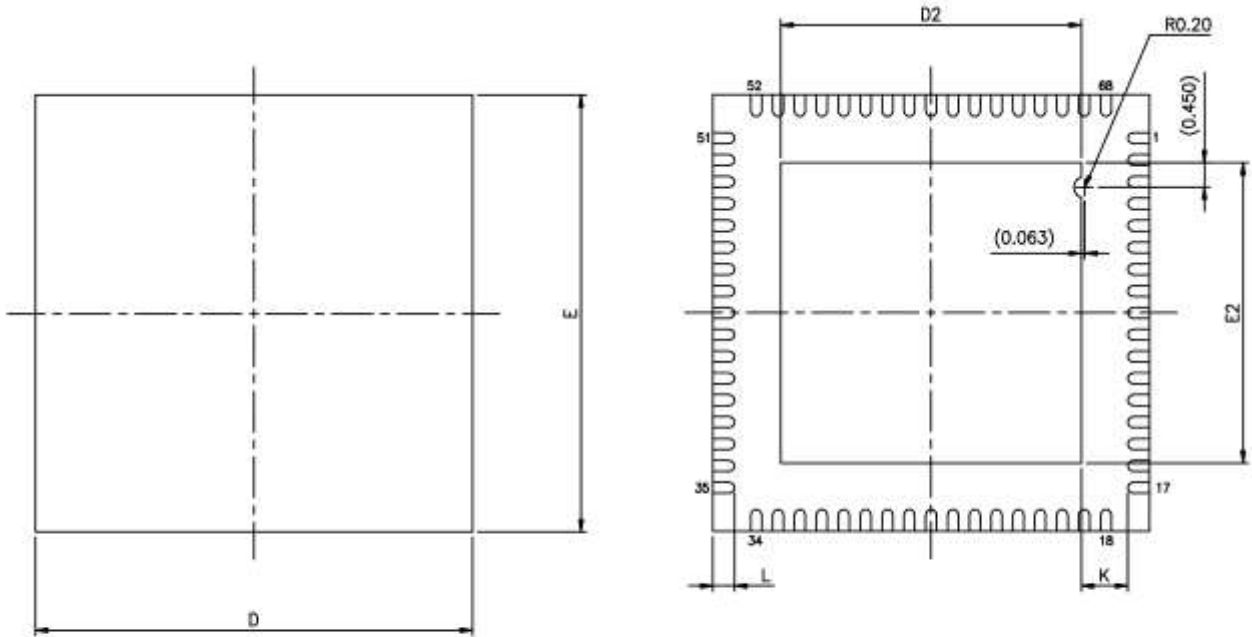

SYMBOLS	MIN.	NOM.	MAX.
A	0.80	0.85	0.90
A1	0.00	0.02	0.05
A3	0.203 REF.		
b	0.15	0.20	0.25
D	8.00 BSC		
E	8.00 BSC		
e	0.40 BSC		
L	0.35	0.40	0.45
K	0.20	—	—



UNIT: mm

PAD SIZE	E2			D2			LEAD FINISH		JEDEC CODE
	MIN.	NOM.	MAX.	MIN.	NOM.	MAX.	Pure Tin	PPF	
	5.40	5.50	5.60	5.40	5.50	5.60	V	X	N/A

**Figure 7-1 QFN-68 Package Dimensions**

**Note:** On the underside of the package, the exposed thermal pad should be connected to GND.



## 7.2 QFN-56 Package Dimensions

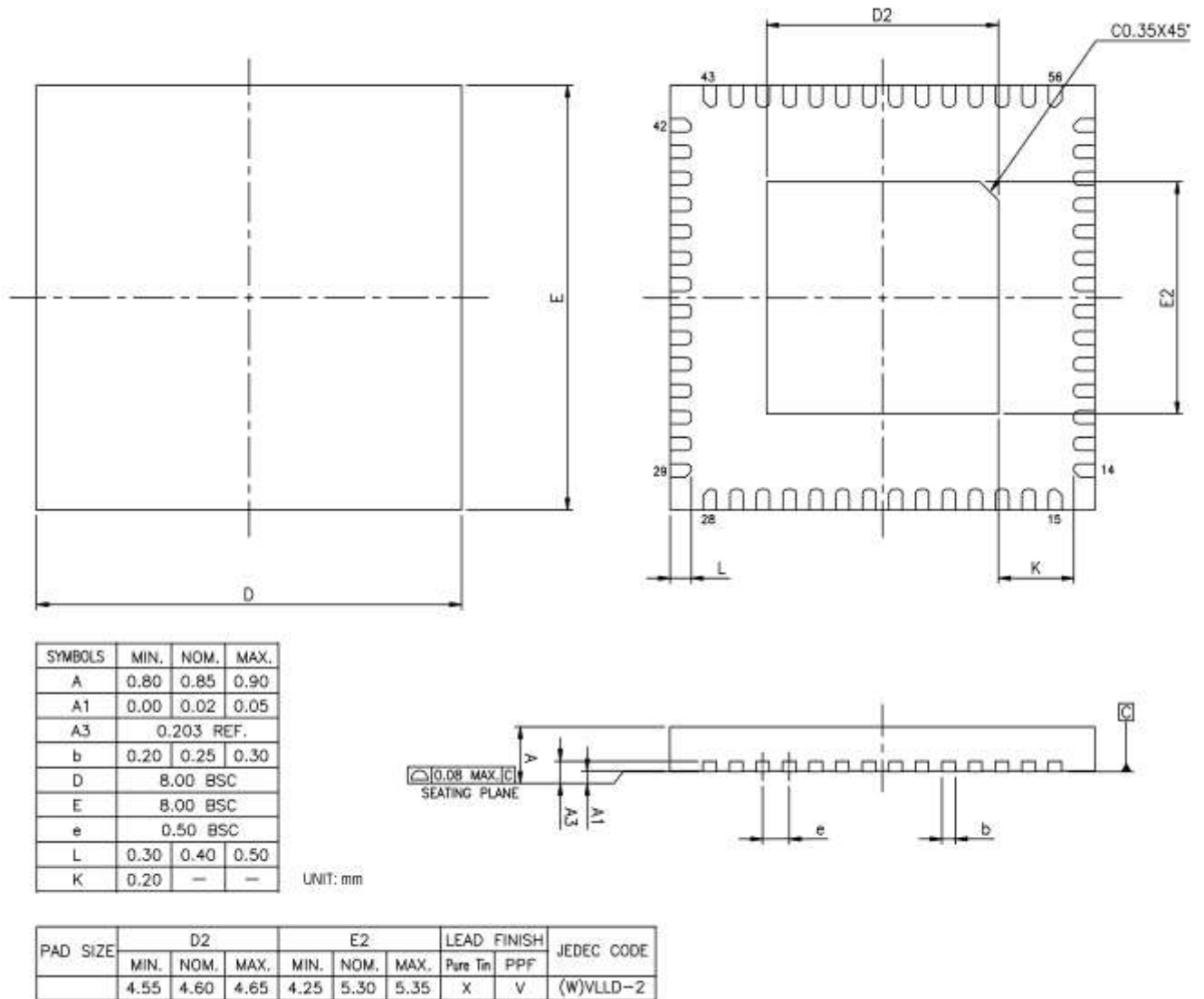

**Figure 7-2 QFN-56 Package Dimensions**

**Note:** On the underside of the package, the exposed thermal pad should be connected to GND.

### 7.3 QFN-48 Package Dimensions

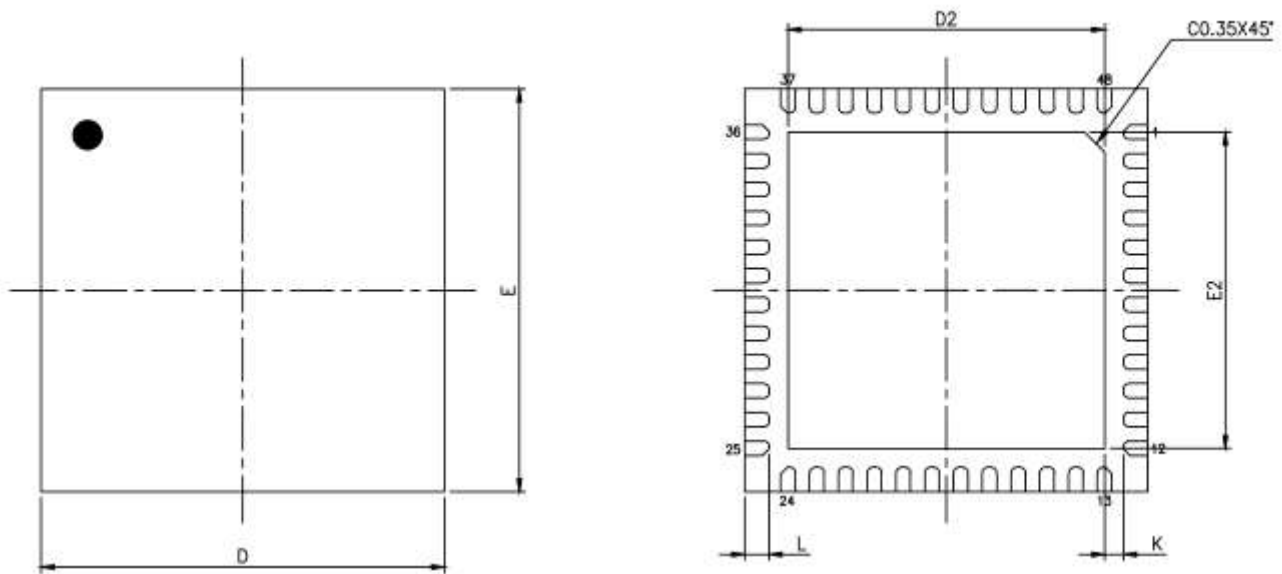

SYMBOLS	MIN.	NOM.	MAX.
A	0.80	0.85	0.90
A1	0.00	0.02	0.05
A3	0.203 REF.		
b	0.20	0.25	0.30
D	7.00 BSC		
E	7.00 BSC		
e	0.50 BSC		

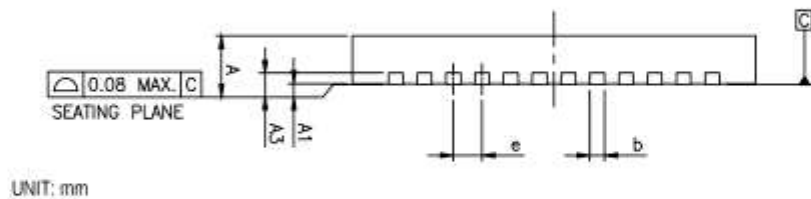

PAD SIZE	D2			E2			L			K			LEAD FINISH		JEDEC CODE
	MIN.	NOM.	MAX.	MIN.	NOM.	MAX.	MIN.	NOM.	MAX.	MIN.	NOM.	MAX.	Pure Tin	PPF	
	5.25	5.30	5.35	5.25	5.30	5.35	0.35	0.40	0.45	0.20	—	—	V	X	N/A

Figure 7-3 QFN-48 Package Dimensions

**Note:** On the underside of the package, the exposed thermal pad should be connected to GND.

## 7.4 QFN-68/56/48 Device Marking

### 7.4.1 FT93XQ Top Side

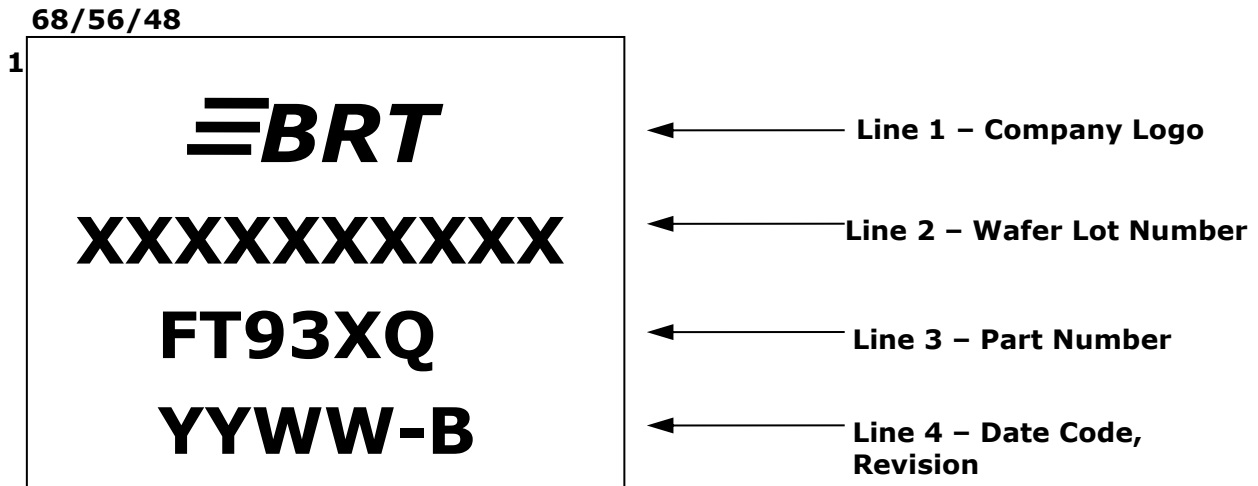

**Figure 7-4 FT93XQ Top Side**

**Notes:**

1. FT93XQ symbol stands for FT930Q, FT931Q, FT932Q, and FT933Q.
2. YYWW = Date Code, where YY is year and WW is week number and following character B indicates the silicon revision B.
3. Pre date code 1727 the company logo was FTDI
4. Marking alignment should be centre justified.
5. Laser marking should be used.

All marking dimensions should be marked proportionally. Marking font should be using standard font (Roman Simplex).

## 7.5 Solder Reflow Profile

The FT93x series is supplied in Pb free QFN-68, QFN-56, and QFN-48 packages. The recommended solder reflow profile for all package options is shown below.



**Figure 7-5 FT93x Solder Reflow Profile**

The recommended values for the solder reflow profile are detailed below. Values are shown for both a completely Pb free solder process (i.e. the FT93x is used with Pb free solder), and for a non-Pb free solder process (i.e. the FT93x is used with non-Pb free solder).

Profile Feature	Pb Free Solder Process	Non-Pb Free Solder Process
Average Ramp Up Rate (Ts to Tp)	3°C / second Max.	3°C / Second Max.
Preheat - Temperature Min (Ts Min.) - Temperature Max (Ts Max.) - Time (ts Min to ts Max)	150°C 200°C 60 to 120 seconds	100°C 150°C 60 to 120 seconds
Time Maintained Above Critical Temperature TL: - Temperature (TL) - Time (tL)	217°C 60 to 150 seconds	183°C 60 to 150 seconds
Peak Temperature (Tp)	260°C	240°C
Time within 5°C of actual Peak Temperature (tp)	20 to 40 seconds	20 to 40 seconds
Ramp Down Rate	6°C / second Max.	6°C / second Max.
Time for T= 25°C to Peak Temperature, Tp	8 minutes Max.	6 minutes Max.

**Table 7-1 Reflow Profile Parameter Values**

## 8 Contact Information

### Headquarters – Singapore

Bridgetek Pte Ltd  
178 Paya Lebar Road, #07-03  
Singapore 409030  
Tel: +65 6547 4827  
Fax: +65 6841 6071

E-mail (Sales) [sales.apac@brtchip.com](mailto:sales.apac@brtchip.com)  
E-mail (Support) [support.apac@brtchip.com](mailto:support.apac@brtchip.com)

### Branch Office – Taipei, Taiwan

Bridgetek Pte Ltd, Taiwan Branch  
2 Floor, No. 516, Sec. 1, Nei Hu Road, Nei Hu District  
Taipei 114  
Taiwan, R.O.C.  
Tel: +886 (2) 8797 5691  
Fax: +886 (2) 8751 9737

E-mail (Sales) [sales.apac@brtchip.com](mailto:sales.apac@brtchip.com)  
E-mail (Support) [support.apac@brtchip.com](mailto:support.apac@brtchip.com)

### Branch Office - Glasgow, United Kingdom

Bridgetek Pte Ltd.  
Unit 1, 2 Seaward Place, Centurion Business Park  
Glasgow G41 1HH  
United Kingdom  
Tel: +44 (0) 141 429 2777  
Fax: +44 (0) 141 429 2758

E-mail (Sales) [sales.emea@brtchip.com](mailto:sales.emea@brtchip.com)  
E-mail (Support) [support.emea@brtchip.com](mailto:support.emea@brtchip.com)

### Branch Office – Vietnam

Bridgetek VietNam Company Limited  
Lutaco Tower Building, 5th Floor, 173A Nguyen Van  
Troj,  
Ward 11, Phu Nhuan District,  
Ho Chi Minh City, Vietnam  
Tel : 08 38453222  
Fax : 08 38455222

E-mail (Sales) [sales.apac@brtchip.com](mailto:sales.apac@brtchip.com)  
E-mail (Support) [support.apac@brtchip.com](mailto:support.apac@brtchip.com)

### Web Site

<http://brtchip.com/>

### Distributor and Sales Representatives

Please visit the Sales Network page of the [Bridgetek Web site](#) for the contact details of our distributor(s) and sales representative(s) in your country.

System and equipment manufacturers and designers are responsible to ensure that their systems, and any Bridgetek Pte Ltd (BRT Chip) devices incorporated in their systems, meet all applicable safety, regulatory and system-level performance requirements. All application-related information in this document (including application descriptions, suggested Bridgetek devices and other materials) is provided for reference only. While Bridgetek has taken care to assure it is accurate, this information is subject to customer confirmation, and Bridgetek disclaims all liability for system designs and for any applications assistance provided by Bridgetek. Use of Bridgetek devices in life support and/or safety applications is entirely at the user's risk, and the user agrees to defend, indemnify and hold harmless Bridgetek from any and all damages, claims, suits or expense resulting from such use. This document is subject to change without notice. No freedom to use patents or other intellectual property rights is implied by the publication of this document. Neither the whole nor any part of the information contained in, or the product described in this document, may be adapted or reproduced in any material or electronic form without the prior written consent of the copyright holder. Bridgetek Pte Ltd, 178 Paya Lebar Road, #07-03, Singapore 409030. Singapore Registered Company Number: 201542387H.

## Appendix A – References

### Document References

[BRT AN 010 FT93x User Manual](#)

[AN 341 FT32 Technical Manual](#)

[FT900 toolchain](#)

[AN 325 Toolchain Installation Guide](#)

[Sample firmware](#)

### Acronyms and Abbreviations

Terms	Description
ADC	Analog-to-Digital Converter
BCD	Battery Charge Device
CDP	Charging Downstream Port
DAC	Digital-to-Analog Converter
DAQ	Data Acquisition
DCP	Dedicated Charging Port
DNL	Differential Nonlinearity
FIFO	First In First Out
GPIO	General Purpose Input / Output
INL	Integral Nonlinearity
I/O	Input/Output
LSB	Least Significant Bit
MMC	Multimedia Card
MSPS	Mega Samples Per Second
NMI	Non-Maskable Interrupt input
POR	Power On Reset
PWM	Pulse Width Modulator
QFN	Quad Flat No-Lead
RTC	Real Time Clock
SD	Secure Digital
SDIO	Secure Digital Input Output
SDP	Standard Downstream Port
SPI	Serial Peripheral Interface
UART	Universal Asynchronous Receiver/Transmitter
UHS	Ultra High Speed
USB	Universal Serial Bus

## Appendix B - List of Figures and Tables

### List of Figures

Figure 2-1 FT930 68-pin Block Diagram .....	4
Figure 3-1 Pin Configuration FT930Q (top-down view) .....	8
Figure 3-2 Pin Configuration FT931Q (top-down view) .....	9
Figure 3-3 Pin Configuration FT932Q (top-down view) .....	10
Figure 3-4 Pin Configuration FT933Q (top-down view) .....	11
Figure 5-1 USB Rise and Fall Times for DP/DM .....	46
Figure 5-2 Definition of I <sup>2</sup> C Timing F/S mode .....	47
Figure 5-3 Definition of I <sup>2</sup> C Timing HS mode .....	48
Figure 5-4 Definition of SPI Master Timing Mode 0 .....	48
Figure 5-5 Definition of SPI Slave Timing Mode 0 .....	49
Figure 6-1 Crystal Oscillator Connection .....	51
Figure 6-2 External clock input .....	51
Figure 6-3 RTC 32.768 KHz Oscillator Connection .....	52
Figure 6-4 External 32.768 KHz Clock Input .....	52
Figure 6-5 GPIO I/O Port Connection .....	53
Figure 6-6 USB2.0 Port Connection .....	53
Figure 6-7 Unused USB Connection (QFN) .....	54
Figure 7-1 QFN-68 Package Dimensions .....	56
Figure 7-2 QFN-56 Package Dimensions .....	57
Figure 7-3 QFN-48 Package Dimensions .....	58
Figure 7-4 FT93XQ Top Side .....	59
Figure 7-5 FT93x Solder Reflow Profile .....	60

## List of Tables

Table 1-1 FT93x Series Part Numbers.....	2
Table 3-1 FT930 Pin Description .....	17
Table 3-2 FT931 Pin Description .....	22
Table 3-3 FT932 Pin Description .....	26
Table 3-4 FT933 Pin Description .....	30
Table 4-1 FT93x Series Default Interrupt Priority .....	33
Table 4-2 FT93x Series I/O Memory Mapping .....	34
Table 5-1 Absolute Maximum Ratings.....	41
Table 5-2 Operating Voltage and Current .....	42
Table 5-3 Digital I/O Pin Characteristics (VCCIO3V3 = +3.3V, Standard Drive Level) .....	43
Table 5-4 USB I/O Pin (D_DP/D_DM) Characteristics.....	44
Table 5-5 System clock characteristics .....	44
Table 5-6 RTC clock characteristics .....	45
Table 5-7 Analog I/O pins (D_DP/D_DM, H_DP/H_DM) characteristics.....	46
Table 5-8 I2C I/O pins (I2C0_SCL/SDA, I2C1_SCL/SDA) characteristics .....	47
Table 5-9 SPI I/O pins (SPIM_CLK/MOSI/MISO/SS0/SS1/SS2/SS3) characteristics .....	48
Table 5-10 SPI I/O pins (SPIS0_CLK/MOSI/MISO/SS, SPIS1_CLK/MOSI/MISO/SS) characteristics.....	49
Table 5-11 ADC Characteristics .....	50
Table 5-12 DAC Characteristics .....	50
Table 7-1 Reflow Profile Parameter Values .....	60



## Appendix C - Revision History

Document Title: FT93x Datasheet Embedded Microcontroller  
Document Reference No.: BRT\_000051  
Clearance No.: BRT#049  
Product Page: <http://brtchip.com/product>  
Document Feedback: [DS\\_FT93x](#)

Revision	Changes	Date
Draft 1.0	Initial Release	2016-11-08
Version 1.1	Updated information about D2XX	2016-11-24
Version 1.4	Removed the MCU's SD-Card Timing Spec since a SD-Host only needs to comply with a SD card timing as specified in the SD-Card Standard	2017-03-09
Version 1.5	Updated the chip marking from FTDI to BRT in the following figures - Fig 3-1, 3-2, 3-3, 3-4, 7-4; Updated the product image on the cover page	2017-06-30

Компания «Life Electronics» занимается поставками электронных компонентов импортного и отечественного производства от производителей и со складов крупных дистрибьюторов Европы, Америки и Азии.

С конца 2013 года компания активно расширяет линейку поставок компонентов по направлению коаксиальный кабель, кварцевые генераторы и конденсаторы (керамические, пленочные, электролитические), за счёт заключения дистрибьюторских договоров

Мы предлагаем:

- Конкурентоспособные цены и скидки постоянным клиентам.
- Специальные условия для постоянных клиентов.
- Подбор аналогов.
- Поставку компонентов в любых объемах, удовлетворяющих вашим потребностям.
- Приемлемые сроки поставки, возможна ускоренная поставка.
- Доставку товара в любую точку России и стран СНГ.
- Комплексную поставку.
- Работу по проектам и поставку образцов.
- Формирование склада под заказчика.
- Сертификаты соответствия на поставляемую продукцию (по желанию клиента).
- Тестирование поставляемой продукции.
- Поставку компонентов, требующих военную и космическую приемку.
- Входной контроль качества.
- Наличие сертификата ISO.

В составе нашей компании организован Конструкторский отдел, призванный помогать разработчикам, и инженерам.

Конструкторский отдел помогает осуществить:

- Регистрацию проекта у производителя компонентов.
- Техническую поддержку проекта.
- Защиту от снятия компонента с производства.
- Оценку стоимости проекта по компонентам.
- Изготовление тестовой платы монтаж и пусконаладочные работы.



Тел: +7 (812) 336 43 04 (многоканальный)  
Email: [org@lifeelectronics.ru](mailto:org@lifeelectronics.ru)