



## Features

- Axial leaded
- Fully compatible with current industry standards
- Weldable nickel terminals
- Very low internal resistance
- Agency recognition:   
- RoHS compliant\*

## Applications

- Rechargeable battery pack protection
- Provides overcurrent protection with 125 °C trip temperature

## MF-S Series - PTC Resettable Fuses

### Electrical Characteristics

Model	V max. Volts	I max. Amps	I <sub>hold</sub>	I <sub>trip</sub>	Initial Resistance		1 Hour (R <sub>1</sub> ) Post-Trip Resistance	Max. Time to Trip		Tripped Power Dissipation
			Amperes at 23 °C		Ohms at 23 °C		Ohms at 23 °C	Amperes at 23 °C	Seconds at 23 °C	Watts at 23 °C
			Hold	Trip	Min.	Max.	Max.			Typ.
MF-S120	15	100	1.20	2.70	0.085	0.160	0.220	6	5.0	1.20
MF-S120S	15	100	1.20	2.70	0.085	0.160	0.220	6	5.0	1.20
MF-S150	15	100	1.50	3.00	0.050	0.090	0.113	8	5.0	1.30
MF-S175	15	100	1.75	3.80	0.050	0.090	0.120	9	4.0	1.50
MF-S175S	15	100	1.75	3.80	0.050	0.090	0.120	9	4.0	1.50
MF-S200	30	100	2.00	4.40	0.030	0.060	0.080	10	4.0	1.90
MF-S350	30	100	3.50	6.30	0.017	0.031	0.040	20	3.0	2.50
MF-S420	30	100	4.20	7.60	0.012	0.024	0.040	20	6.0	2.90

NOTE: Slotted lead option available on all models.

### Environmental Characteristics

Operating/Storage Temperature.....	-40 °C to +85 °C
Maximum Device Surface Temperature in Tripped State .....	125 °C
Passive Aging.....	+85 °C, 1000 hours..... ±5 % typical resistance change
Humidity Aging.....	+85 °C, 85% R.H. 7 days..... ±5 % typical resistance change
Vibration .....	MIL-STD-883C, Method 2007.1,..... No change Condition A

### Test Procedures And Requirements For Model MF-S Series

Test	Test Conditions	Accept/Reject Criteria
Visual/Mech.....	Verify dimensions and materials.....	Per MF physical description
Resistance.....	In still air @ 23 °C.....	R <sub>min</sub> ≤ R ≤ R <sub>1max</sub>
Time to Trip.....	At specified current, V <sub>max</sub> , 23 °C.....	T ≤ max. time to trip (seconds)
Hold Current.....	30 min. at I <sub>hold</sub> .....	No trip
Trip Cycle Life.....	V <sub>max</sub> , I <sub>max</sub> , 100 cycles.....	No arcing or burning
Trip Endurance.....	V <sub>max</sub> , 48 hours.....	No arcing or burning

UL File Number .....	E 174545S
CSA File Number.....	CA 110338
TÜV File Number .....	R2057213

### Thermal Derating Chart - I<sub>hold</sub> / I<sub>trip</sub> (Amps)

Model	Ambient Operating Temperature								
	-40 °C	-20 °C	0 °C	23 °C	40 °C	50 °C	60 °C	70 °C	85 °C
MF-S120	1.90 / 4.28	1.70 / 3.83	1.50 / 3.38	1.20 / 2.70	1.00 / 2.25	0.90 / 2.03	0.80 / 1.80	0.70 / 1.58	0.50 / 1.13
MF-S120S	1.90 / 4.28	1.70 / 3.83	1.50 / 3.38	1.20 / 2.70	1.00 / 2.25	0.90 / 2.03	0.80 / 1.80	0.70 / 1.58	0.50 / 1.13
MF-S150	2.20 / 4.40	2.00 / 4.00	1.80 / 3.60	1.50 / 3.00	1.30 / 2.60	1.10 / 2.20	1.00 / 2.00	0.90 / 1.80	0.70 / 1.40
MF-S175	2.50 / 5.59	2.30 / 5.14	2.00 / 4.47	1.70 / 3.80	1.50 / 3.35	1.30 / 2.91	1.20 / 2.68	1.10 / 2.46	0.90 / 2.01
MF-S175S	2.50 / 5.59	2.30 / 5.14	2.00 / 4.47	1.70 / 3.80	1.50 / 3.35	1.30 / 2.91	1.20 / 2.68	1.10 / 2.46	0.90 / 2.01
MF-S200	3.20 / 7.04	2.80 / 6.16	2.50 / 5.50	2.00 / 4.40	1.70 / 3.74	1.60 / 3.52	1.40 / 3.08	1.20 / 2.64	0.90 / 1.98
MF-S350	5.40 / 9.72	4.80 / 8.64	4.30 / 7.74	3.50 / 6.30	3.00 / 5.40	2.80 / 5.04	2.50 / 4.50	2.20 / 3.96	1.70 / 3.06
MF-S420	6.40 / 11.5	5.70 / 10.3	5.10 / 9.23	4.20 / 7.60	3.60 / 6.51	3.30 / 5.97	3.00 / 5.43	2.60 / 4.70	2.10 / 3.80

\*RoHS Directive 2002/95/EC Jan 27, 2003 including Annex.

Specifications are subject to change without notice.

Customers should verify actual device performance in their specific applications.

# MF-S Series - PTC Resettable Fuses

# BOURNS®

## Product Dimensions

Model	A		B		C		D		F	
	Min.	Max.	Min.	Max.	Min.	Max.	Min.	Max.	Min.	Max.
MF-S120	19.9 (0.783)	22.1 (0.870)	4.9 (0.193)	5.2 (0.205)	0.6 (0.024)	1.0 (0.039)	5.5 (0.217)	7.5 (0.295)	3.8 (0.150)	4.1 (0.161)
MF-S120S	19.9 (0.783)	22.1 (0.870)	4.9 (0.193)	5.2 (0.205)	0.6 (0.024)	1.0 (0.039)	5.5 (0.217)	7.5 (0.295)	3.8 (0.150)	4.1 (0.161)
MF-S150	21.3 (0.839)	23.4 (0.921)	10.2 (0.402)	11.0 (0.433)	0.5 (0.020)	1.1 (0.043)	4.1 (0.161)	5.5 (0.217)	4.8 (0.189)	5.4 (0.213)
MF-S175	20.9 (0.823)	23.1 (0.909)	4.9 (0.193)	5.2 (0.205)	0.6 (0.024)	1.0 (0.039)	4.1 (0.161)	5.5 (0.217)	3.8 (0.150)	4.1 (0.161)
MF-S175S	20.9 (0.823)	23.1 (0.909)	4.9 (0.193)	5.2 (0.205)	0.6 (0.024)	1.0 (0.039)	4.1 (0.161)	5.5 (0.217)	3.8 (0.150)	4.1 (0.161)
MF-S200	21.3 (0.839)	23.4 (0.921)	10.2 (0.402)	11.0 (0.433)	0.5 (0.020)	1.1 (0.043)	5.0 (0.197)	7.6 (0.299)	4.8 (0.189)	5.4 (0.213)
MF-S350	28.4 (1.119)	31.8 (1.252)	13.0 (0.512)	13.5 (0.531)	0.5 (0.020)	1.1 (0.043)	6.3 (0.248)	8.9 (0.350)	6.0 (0.236)	6.6 (0.260)
MF-S420	30.6 (1.205)	32.4 (1.276)	12.9 (0.508)	13.6 (0.535)	0.5 (0.020)	1.1 (0.043)	5.0 (0.197)	7.5 (0.295)	6.0 (0.236)	6.6 (0.260)

Packaging: Bulk - 500 pcs. per bag.  
Tape and Reel - Consult factory.

DIMENSIONS:  $\frac{\text{MM}}{\text{(INCHES)}}$

### Standard Style

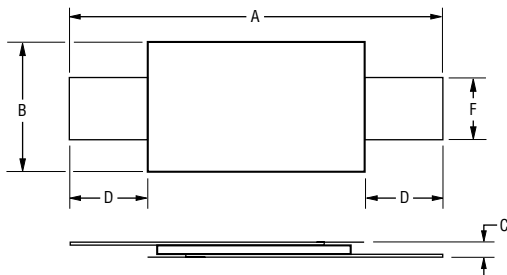

### "S" Style

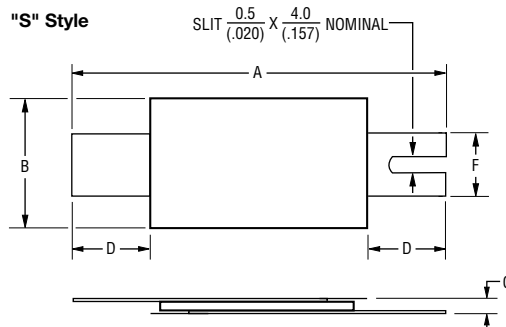

Terminal material: quarter-hard nickel

### Typical Part Marking

Represents total content. Layout may vary.

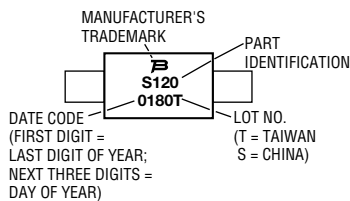

Specifications are subject to change without notice.  
Customers should verify actual device performance in their specific applications.

# MF-S Series - PTC Resettable Fuses

**BOURNS®**

## Typical Time to Trip at 23 °C

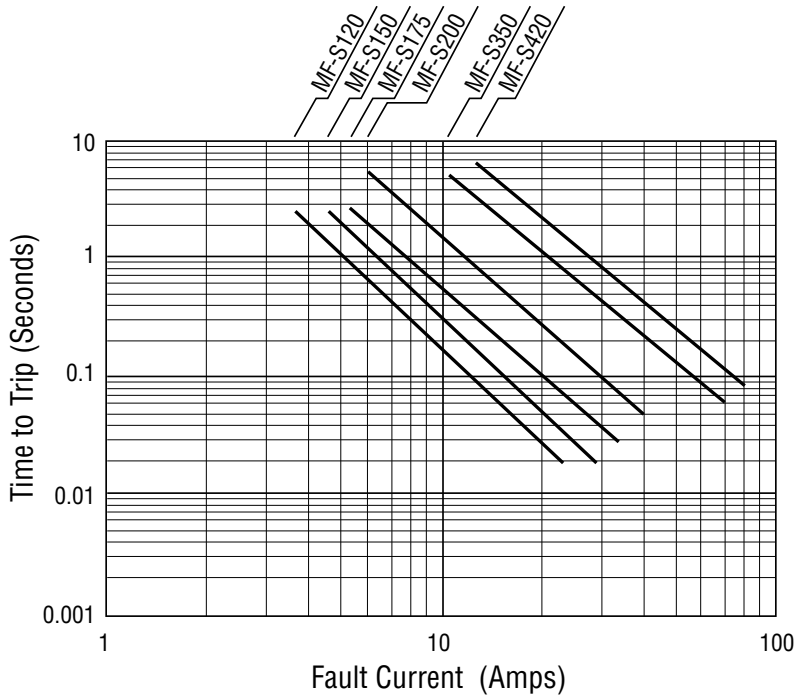

## How to Order

**MF - S 120 S -**

Multifuse® Product Designator \_\_\_\_\_

Series \_\_\_\_\_

S = Axial Leaded "Strap" Component

Hold Current,  $I_{hold}$  \_\_\_\_\_  
 120-420 (1.20 Amps - 4.20 Amps)

Slotted Lead Option \_\_\_\_\_

Packaging Options \_\_\_\_\_

- = Bulk Packaging
- 2 = Tape and Reel\*

\*Packaged per EIA486-B

**Taped Component Dimensions**

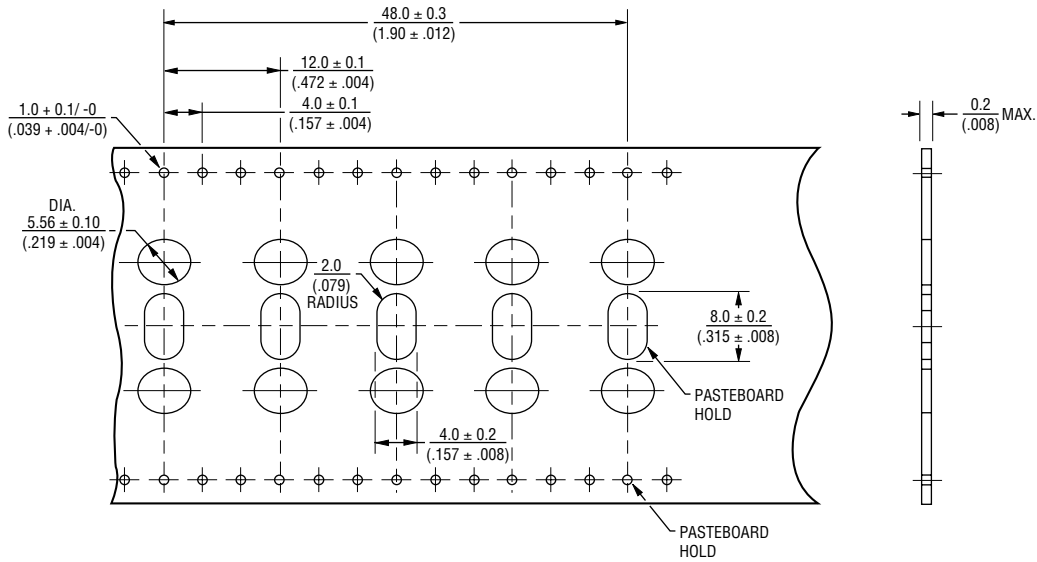

**Reel Dimensions**

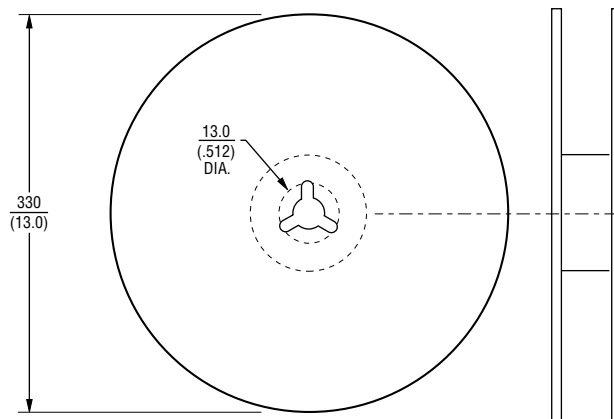

DIMENSIONS:  $\frac{\text{MM}}{\text{(INCHES)}}$

Компания «Life Electronics» занимается поставками электронных компонентов импортного и отечественного производства от производителей и со складов крупных дистрибьюторов Европы, Америки и Азии.

С конца 2013 года компания активно расширяет линейку поставок компонентов по направлению коаксиальный кабель, кварцевые генераторы и конденсаторы (керамические, пленочные, электролитические), за счёт заключения дистрибьюторских договоров

Мы предлагаем:

- Конкуренспособные цены и скидки постоянным клиентам.
- Специальные условия для постоянных клиентов.
- Подбор аналогов.
- Поставку компонентов в любых объемах, удовлетворяющих вашим потребностям.
- Приемлемые сроки поставки, возможна ускоренная поставка.
- Доставку товара в любую точку России и стран СНГ.
- Комплексную поставку.
- Работу по проектам и поставку образцов.
- Формирование склада под заказчика.
- Сертификаты соответствия на поставляемую продукцию (по желанию клиента).
- Тестирование поставляемой продукции.
- Поставку компонентов, требующих военную и космическую приемку.
- Входной контроль качества.
- Наличие сертификата ISO.

В составе нашей компании организован Конструкторский отдел, призванный помогать разработчикам, и инженерам.

Конструкторский отдел помогает осуществить:

- Регистрацию проекта у производителя компонентов.
- Техническую поддержку проекта.
- Защиту от снятия компонента с производства.
- Оценку стоимости проекта по компонентам.
- Изготовление тестовой платы монтаж и пусконаладочные работы.



Тел: +7 (812) 336 43 04 (многоканальный)

Email: [org@lifeelectronics.ru](mailto:org@lifeelectronics.ru)