

Features

- Primarily Designed for Driving LED/s for Illumination, Signage and Backlighting Applications
- Ideally Suited for Linear Mode Constant Current Applications
- V_{BE} Referenced Current Sink Circuit
- Includes:
 - N-Channel Enhancement Mode MOSFET (Q1)
 - Base Accessible Pre-Biased Transistor (Q2)
- High Voltage Capable (50V)
- Small Form Factor Surface Mount Package
- High Dissipation Capability
- Low Thermal Resistance
- Lead Free By Design/RoHS Compliant (Note 1)**
- "Green" Device (Note 2)**
- Qualified to AEC-Q101 Standards for High Reliability**

Mechanical Data

- Case: DFN3030D-8
- Case Material: Molded Plastic, "Green" Molding Compound. UL Flammability Classification Rating 94V-0
- Moisture Sensitivity: Level 1 per J-STD-020
- Terminals: Finish — NiPdAu over Copper leadframe. Solderable per MIL-STD-202, Method 208
- Marking Information: See Page 7
- Ordering Information: See Page 7
- Weight: 0.0172 grams (approximate)

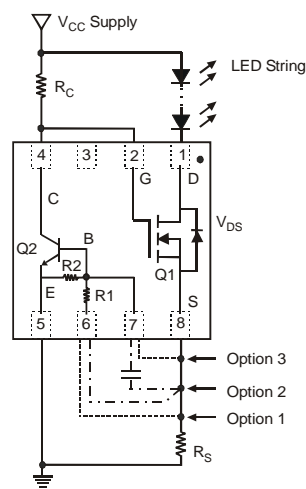
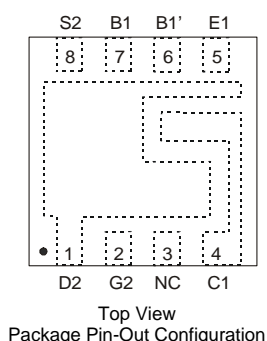
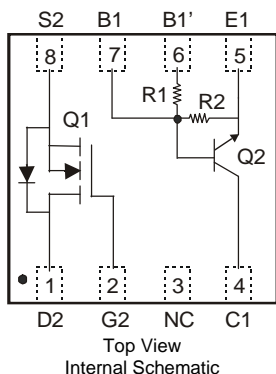

Option 3:
 $I_{LED} \approx \frac{V_{BE}}{R_S}$
 Options 1 & 2:
 $I_{LED} \approx \frac{1.1 V_{BE}}{R_S}$
 Option 2:
 Capacitor is across R2 for better noise performance.

Typical Application Circuit for Linear Mode Current Sink LED Driver

Maximum Ratings: (Q1) @ $T_A = 25^\circ\text{C}$ unless otherwise specified

Characteristic	Symbol	Value	Unit
Drain Source Voltage	V_{DSS}	100	V
Gate-Source Voltage	V_{GSS}	± 20	V
Drain Current (Note 3)	I_D	1.0 0.8	A
		$T_A = 25^\circ\text{C}$ $T_A = 70^\circ\text{C}$	
Drain Current (Note 3)	I_{DM}	3.0	A
		Pulsed	
Body-Diode Continuous Current (Note 3)	I_S	1.0	A

Maximum Ratings: (Q2) @ $T_A = 25^\circ\text{C}$ unless otherwise specified

Characteristic	Symbol	Value	Unit
Supply Voltage	V_{CC}	50	V
Input Voltage	V_{IN}	-5 to +30	V
Output Current (DC)	I_O	100	mA

Notes: 1. No purposefully added lead.
 2. Diodes Inc.'s "Green" policy can be found on our website at http://www.diodes.com/products/lead_free/index.php.

Thermal Characteristics – Total Device

Characteristic	Symbol	Value	Unit
Power Dissipation @ $T_A = 25^\circ\text{C}$	P_D	0.7 (Note 3) 0.9 (Note 4) 1.4 (Note 5)	W
Thermal Resistance Junction to Ambient @ $T_A = 25^\circ\text{C}$	$R_{\theta JA}$	See Figure 1 (Notes 3, 4, & 5)	$^\circ\text{C/W}$
Thermal Resistance Junction to Case @ $T_A = 25^\circ\text{C}$	$R_{\theta JC}$	See Figure 2 (Notes 3, 4, & 5)	$^\circ\text{C/W}$
Operating and Storage Temperature Range	T_J, T_{STG}	-55 to +150	$^\circ\text{C}$

Notes: 3. Part mounted on FR-4 substrate PC board, with minimum recommended pad layout (see page 6).
 4. Part mounted on FR-4 substrate PC board, 2oz Copper with 6 mm² Cu Area, MOSFET element activated.
 5. Part mounted on FR-4 substrate PC board, 2oz Copper with 35 mm² Cu Area, MOSFET element activated.

Electrical Characteristics: (Q1) @ $T_A = 25^\circ\text{C}$ unless otherwise specified

Characteristic	Symbol	Min	Typ	Max	Unit	Test Condition
OFF CHARACTERISTICS (Note 6)						
Drain-Source Breakdown Voltage	BV_{DSS}	100	—	—	V	$V_{GS} = 0V, I_D = 250\mu\text{A}$
Zero Gate Voltage Drain Current	I_{DSS}	—	—	1	μA	$V_{DS} = 60V, V_{GS} = 0V$
Gate-Source Leakage	I_{GSS}	—	—	± 100	nA	$V_{GS} = \pm 20V, V_{DS} = 0V$
ON CHARACTERISTICS (Note 6)						
Gate Threshold Voltage	$V_{GS(th)}$	2.0	—	4.1	V	$V_{DS} = V_{GS}, I_D = 250\mu\text{A}$
Static Drain-Source On-Resistance	$R_{DS(on)}$	—	—	0.85 0.99	Ω	$V_{GS} = 10V, I_D = 1.5A$ $V_{GS} = 6V, I_D = 1A$
Forward Transconductance	g_{fs}	—	0.9	—	S	$V_{DS} = 15V, I_D = 1A$
Diode Forward Voltage	V_{SD}	—	0.89	1.1	V	$V_{GS} = 0V, I_S = 1.5A$
DYNAMIC CHARACTERISTICS						
Input Capacitance	C_{iss}	—	129	—	pF	$V_{DS} = 50V, V_{GS} = 0V$ $f = 1.0\text{MHz}$
Output Capacitance	C_{oss}	—	14	—	pF	
Reverse Transfer Capacitance	C_{rss}	—	8	—	pF	
SWITCHING CHARACTERISTICS						
Total Gate Charge	Q_g	—	3.4	—	nC	$V_{DS} = 50V, V_{GS} = 10V, I_D = 1A$
Gate-Source Charge	Q_{gs}	—	0.9	—		
Gate-Drain Charge	Q_{gd}	—	1	—		
Turn-On Delay Time	$t_{d(on)}$	—	7.9	—	ns	$V_{GS} = 50V, V_{DS} = 10V,$ $I_D = 1A, R_G \approx 6\Omega$
Rise Time	t_r	—	11.4	—		
Turn-Off Delay Time	$t_{d(off)}$	—	14.3	—		
Fall Time	t_f	—	9.6	—		

Electrical Characteristics: (Q2) @ $T_A = 25^\circ\text{C}$ unless otherwise specified

Characteristic (Note 6)	Symbol	Min	Typ	Max	Unit	Test Condition
Input Voltage	$V_{I(off)}$	0.4	-	-	V	$V_{CC} = 5V, I_O = 100\mu\text{A}$
	$V_{I(on)}$	-	-	1.5	V	$V_{CC} = 0.3V, I_O = 5\text{mA}$
Output Voltage	$V_{O(on)}$	-	0.05	0.3	V	$I_O/I_I = 5\text{mA}/0.25\text{mA}$
Output Current	$I_{O(off)}$	-	-	0.5	μA	$V_{CC} = 50V, V_I = 0V$
DC Current Gain	G_1	80	-	-	-	$V_O = 5V, I_O = 10\text{mA}$
Input Resistance	R_1	3.2	4.7	6.2	k Ω	-
Resistance Ratio	R_2/R_1	8	10	12	-	-
Transition Frequency	f_T	-	260	-	MHz	$V_{CE} = 10V, I_E = 5\text{mA},$ $f = 100\text{MHz}$

Notes: 6. Short duration pulse test used to minimize self-heating effect.

Thermal Characteristics

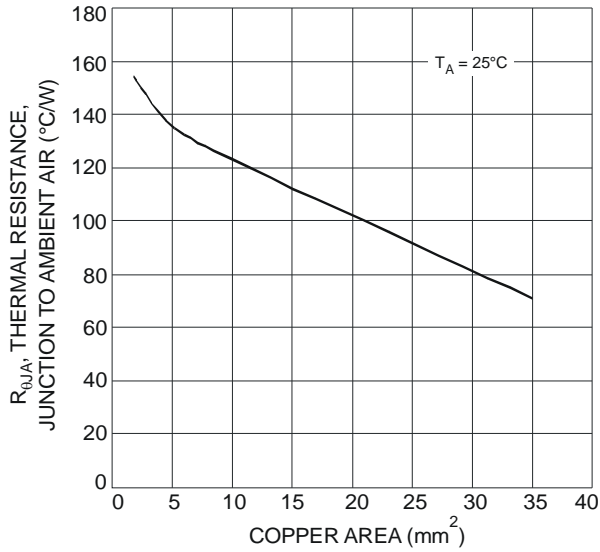

Fig. 1 Thermal Resistance, Junction to Ambient Air Characteristic

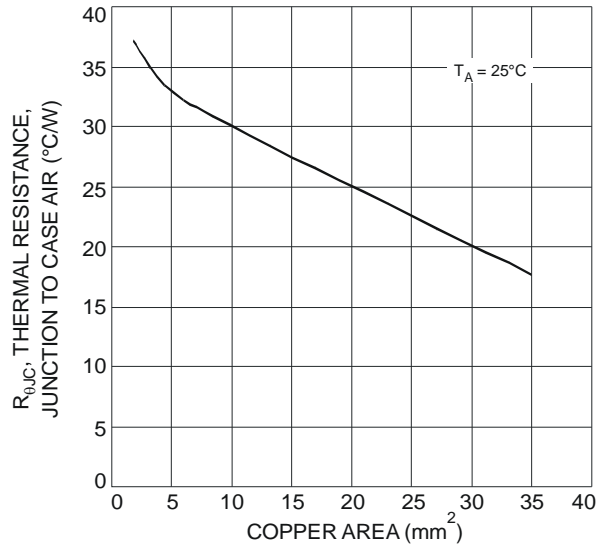

Fig. 2 Thermal Resistance, Junction to Case Air Characteristic

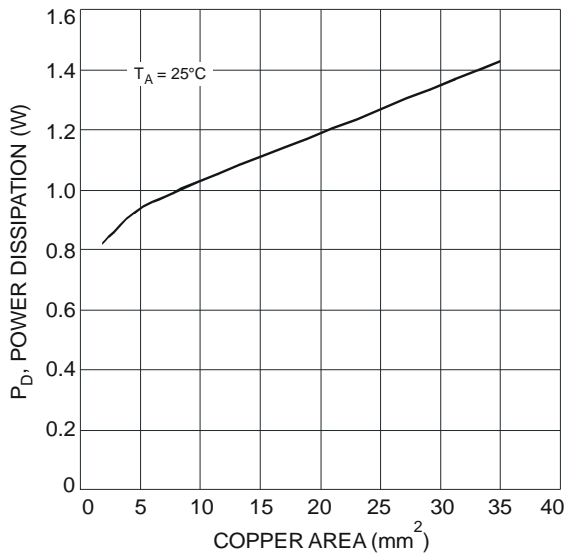

Fig. 3 Power Dissipation Characteristic

Q1 Typical Performance Curves

NEW PRODUCT

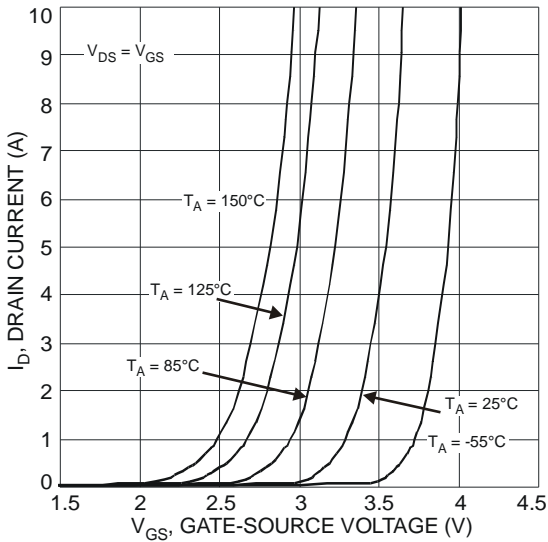

Fig. 4 Typical Transfer Characteristic

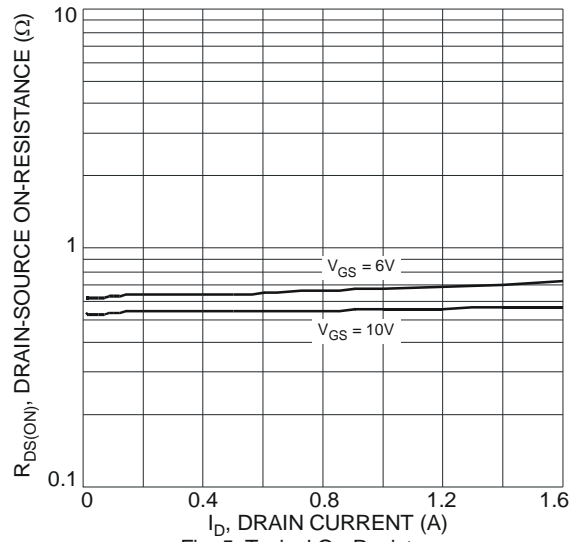

Fig. 5 Typical On-Resistance vs. Drain Current and Gate Voltage

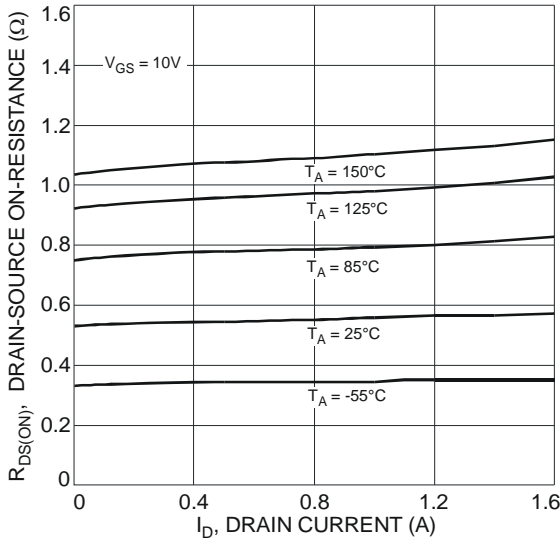

Fig. 6 Typical On-Resistance vs. Drain Current and Temperature

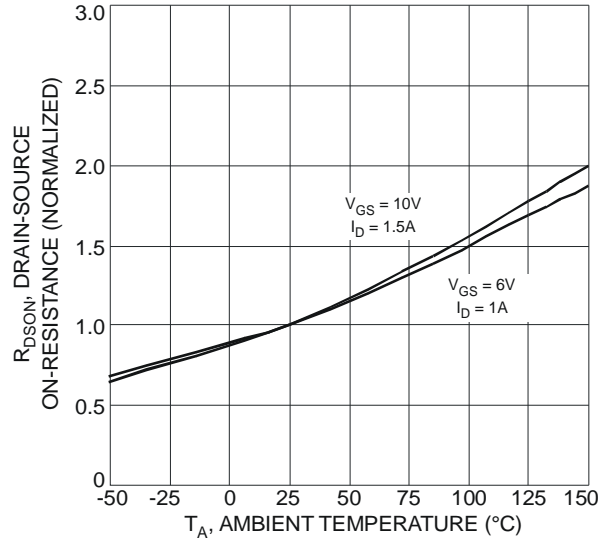

Fig. 7 On-Resistance Variation with Temperature

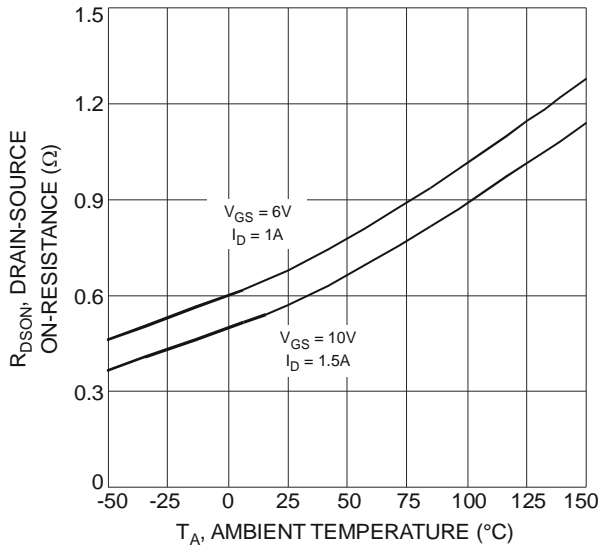

Fig. 8 On-Resistance Variation with Temperature

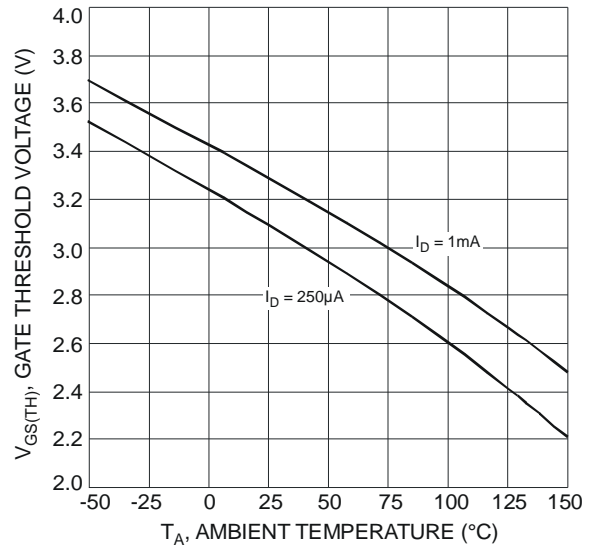

Fig. 9 Gate Threshold Variation vs. Ambient Temperature

Q1 Typical Performance Curves - continued

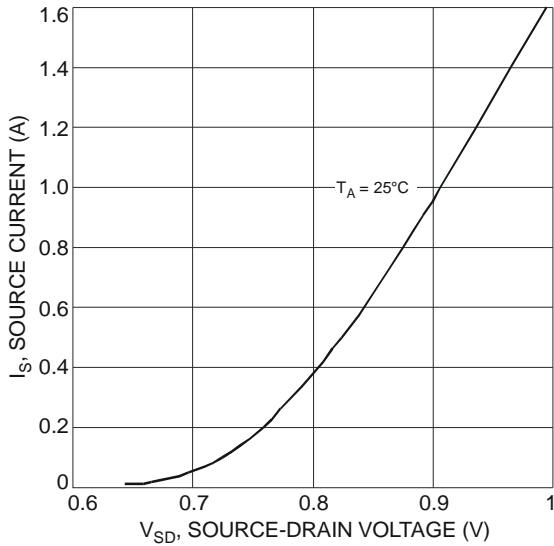

Fig. 10 Source-Drain Diode Forward Voltage vs. Current

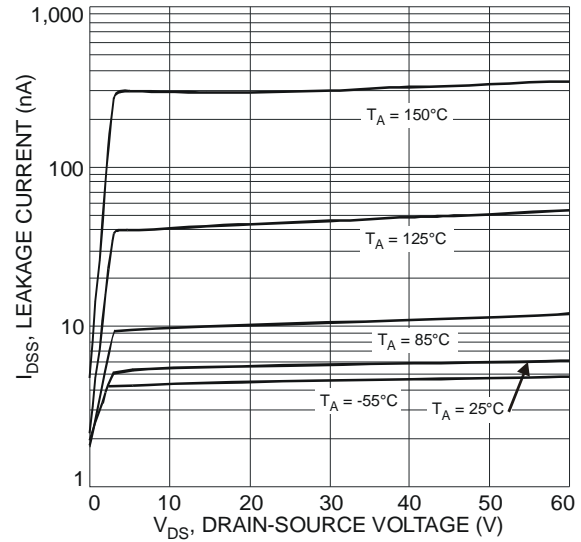

Fig. 11 Typical Leakage Current vs. Drain-Source Voltage

Q2 Typical Performance Curves

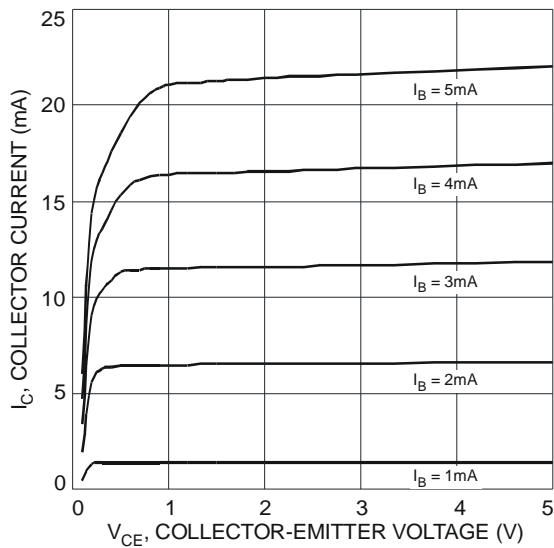

Fig. 12 Typical Collector Current vs. Collector-Emitter Voltage

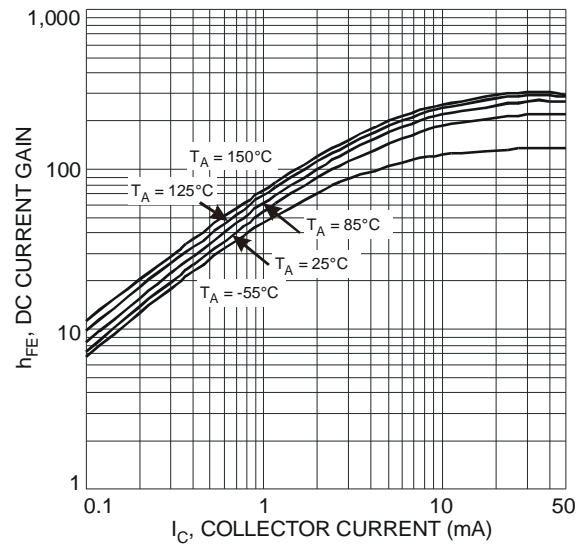

Fig. 13 Typical DC Current Gain vs. Collector Current

Q2 Typical Performance Curves - continued

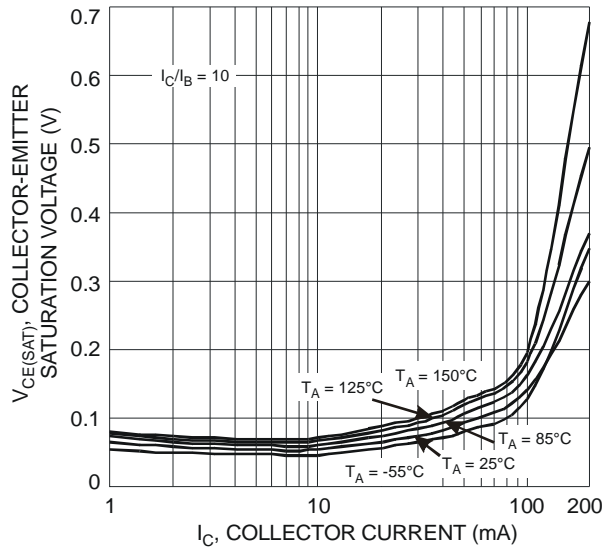

Fig. 14 Typical Collector-Emitter Saturation Voltage vs. Collector Current

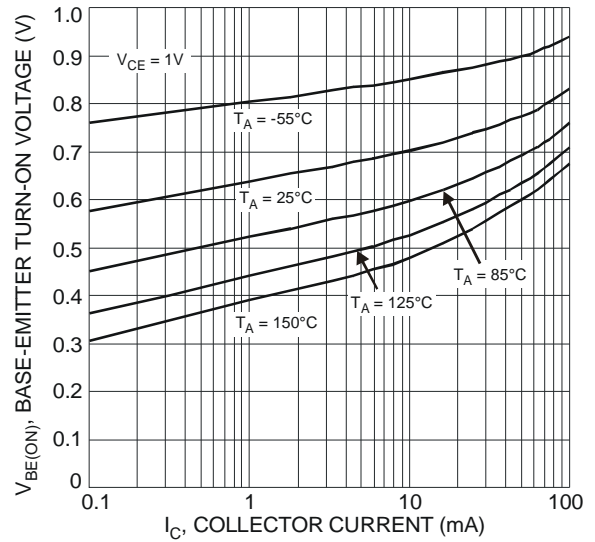

Fig. 15 Base-Emitter Turn-On Voltage vs. Collector Current

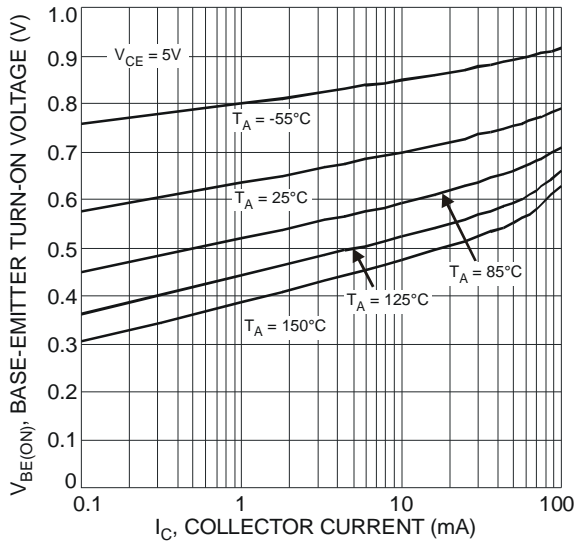
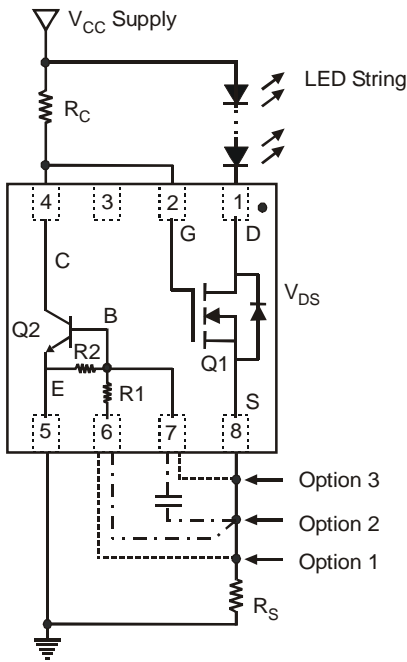

Fig. 16 Base-Emitter Turn-On Voltage vs. Collector Current

Typical Application Circuit



Option 3:

$$I_{LED} \approx \frac{V_{BE}}{R_S}$$

Options 1 & 2:

$$I_{LED} \approx \frac{1.1 V_{BE}}{R_S}$$

Option 2:

Capacitor is across R2 for better noise performance.

The DLD101 has been designed primarily for solid state lighting applications, to be used as a current sink circuit solution for LEDs. It features a N-channel MOSFET capable of 1A drive current and a pre-biased NPN transistor (which allows direct connection to the base, or via a series base resistor).

Figure 12 shows a typical application circuit diagram for driving an LED or string of LEDs. Note that the pre-biased transistor (Q2) has the option of bypassing the series base resistor by connecting directly to pin 7. The N-MOSFET (Q1) is configured as a V_{BE} referenced current sink and is biased on by R_C . The current passed through the LED string, MOSFET and source resistor, develops a voltage across R_S that provides a bias to the NPN transistor. Consideration of the expected linear mode power dissipation must be factored into the design, with respect to the DLD101's thermal resistance.

$$V_{DS} = V_{CC} - V_F \text{ LED String} - V_{RS}$$

$$P_{Q1} = V_{DS} * I_{LED \text{ String}}$$

PWM dimming functionality can be effected by either driving the NPN base via an additional resistor (thereby overriding the feedback from R_S) or by pulling the gate of the MOSFET down by direct connection. The PWM control pulse stream can be provided by a micro-controller or simple 555 based circuitry.

Fig. 12 Typical Application Circuit for Linear Mode Current Sink LED Driver

Ordering Information (Note 7)

Part Number	Case	Packaging
DLD101-7	DFN3030D-8	3000/Tape & Reel

Notes: 7. For packaging details, go to our website at <http://www.diodes.com/datasheets/ap02007.pdf>.

Marking Information

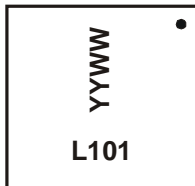

L101 = Product marking code
 YYWW = Date code marking
 YY = Last digit of year (ex: 10 for 2010)
 WW = Week code (01 to 53)

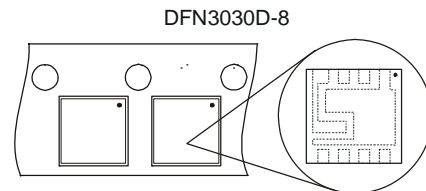

Package Outline Dimensions

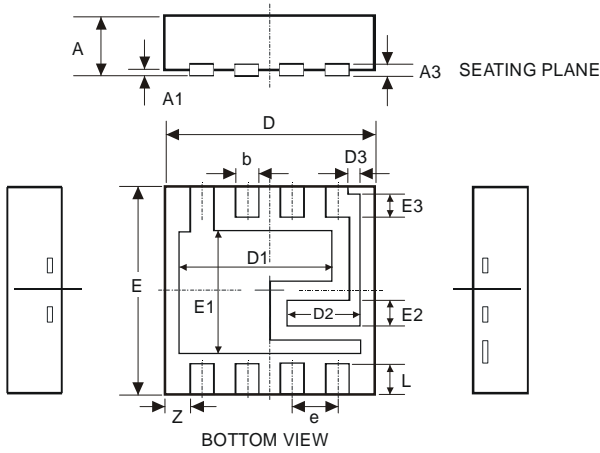

DFN3030D-8							
Dim	Min	Max	Typ	Dim	Min	Max	Typ
A	0.570	0.630	0.600	e	-	-	0.650
A1	0	0.050	0.020	E	2.950	3.075	3.000
A3	-	-	0.150	E1	1.800	2.000	1.900
b	0.290	0.390	0.340	E2	0.290	0.490	0.390
D	2.950	3.075	3.000	E3	0.175	0.375	0.275
D1	2.175	2.375	2.275	L	0.300	0.40	0.350
D2	0.980	1.180	1.080	Z	-	-	0.355
D3	0.105	0.305	0.205				
All Dimensions in mm							

Suggested Pad Layout

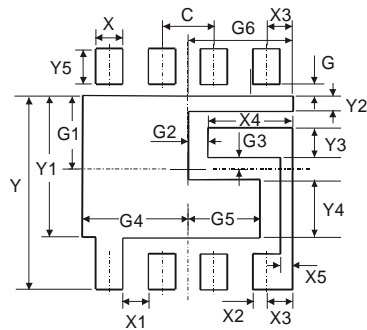

Dimensions	Value (in mm)	Dimensions	Value (in mm)
C	0.650	X2	0.220
G	0.150	X3	0.375
G1	0.950	X4	1.080
G2	0.270	X5	0.150
G3	0.135	Y	2.600
G4	1.350	Y1	1.900
G5	0.925	Y2	0.150
G6	1.350	Y3	0.390
X	0.440	Y4	0.815
X1	0.210	Y5	0.550

IMPORTANT NOTICE

DIODES INCORPORATED MAKES NO WARRANTY OF ANY KIND, EXPRESS OR IMPLIED, WITH REGARDS TO THIS DOCUMENT, INCLUDING, BUT NOT LIMITED TO, THE IMPLIED WARRANTIES OF MERCHANTABILITY AND FITNESS FOR A PARTICULAR PURPOSE (AND THEIR EQUIVALENTS UNDER THE LAWS OF ANY JURISDICTION).

Diodes Incorporated and its subsidiaries reserve the right to make modifications, enhancements, improvements, corrections or other changes without further notice to this document and any product described herein. Diodes Incorporated does not assume any liability arising out of the application or use of this document or any product described herein; neither does Diodes Incorporated convey any license under its patent or trademark rights, nor the rights of others. Any Customer or user of this document or products described herein in such applications shall assume all risks of such use and will agree to hold Diodes Incorporated and all the companies whose products are represented on Diodes Incorporated website, harmless against all damages.

Diodes Incorporated does not warrant or accept any liability whatsoever in respect of any products purchased through unauthorized sales channel. Should Customers purchase or use Diodes Incorporated products for any unintended or unauthorized application, Customers shall indemnify and hold Diodes Incorporated and its representatives harmless against all claims, damages, expenses, and attorney fees arising out of, directly or indirectly, any claim of personal injury or death associated with such unintended or unauthorized application.

Products described herein may be covered by one or more United States, international or foreign patents pending. Product names and markings noted herein may also be covered by one or more United States, international or foreign trademarks.

LIFE SUPPORT

Diodes Incorporated products are specifically not authorized for use as critical components in life support devices or systems without the express written approval of the Chief Executive Officer of Diodes Incorporated. As used herein:

A. Life support devices or systems are devices or systems which:

1. are intended to implant into the body, or
2. support or sustain life and whose failure to perform when properly used in accordance with instructions for use provided in the labeling can be reasonably expected to result in significant injury to the user.

B. A critical component is any component in a life support device or system whose failure to perform can be reasonably expected to cause the failure of the life support device or to affect its safety or effectiveness.

Customers represent that they have all necessary expertise in the safety and regulatory ramifications of their life support devices or systems, and acknowledge and agree that they are solely responsible for all legal, regulatory and safety-related requirements concerning their products and any use of Diodes Incorporated products in such safety-critical, life support devices or systems, notwithstanding any devices- or systems-related information or support that may be provided by Diodes Incorporated. Further, Customers must fully indemnify Diodes Incorporated and its representatives against any damages arising out of the use of Diodes Incorporated products in such safety-critical, life support devices or systems.

Copyright © 2010, Diodes Incorporated

www.diodes.com

Компания «Life Electronics» занимается поставками электронных компонентов импортного и отечественного производства от производителей и со складов крупных дистрибьюторов Европы, Америки и Азии.

С конца 2013 года компания активно расширяет линейку поставок компонентов по направлению коаксиальный кабель, кварцевые генераторы и конденсаторы (керамические, пленочные, электролитические), за счёт заключения дистрибьюторских договоров

Мы предлагаем:

- Конкуренеспособные цены и скидки постоянным клиентам.
- Специальные условия для постоянных клиентов.
- Подбор аналогов.
- Поставку компонентов в любых объемах, удовлетворяющих вашим потребностям.
- Приемлемые сроки поставки, возможна ускоренная поставка.
- Доставку товара в любую точку России и стран СНГ.
- Комплексную поставку.
- Работу по проектам и поставку образцов.
- Формирование склада под заказчика.
- Сертификаты соответствия на поставляемую продукцию (по желанию клиента).
- Тестирование поставляемой продукции.
- Поставку компонентов, требующих военную и космическую приемку.
- Входной контроль качества.
- Наличие сертификата ISO.

В составе нашей компании организован Конструкторский отдел, призванный помогать разработчикам, и инженерам.

Конструкторский отдел помогает осуществить:

- Регистрацию проекта у производителя компонентов.
- Техническую поддержку проекта.
- Защиту от снятия компонента с производства.
- Оценку стоимости проекта по компонентам.
- Изготовление тестовой платы монтаж и пусконаладочные работы.



Тел: +7 (812) 336 43 04 (многоканальный)
Email: org@lifeelectronics.ru