

RoHS **HTxxx & HTMxxx & STxxx Series**

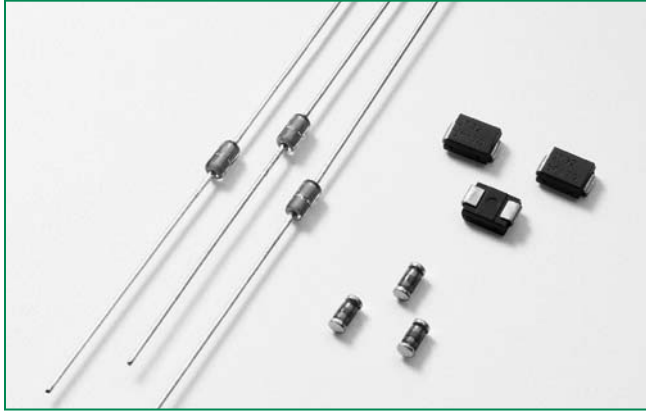

Schematic Symbol

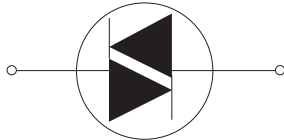

Description

The HTM, HT, and ST series of bilateral trigger DIACs offer a range of voltage characteristics from 27V to 70V. A DIAC semiconductor is a full-wave or bidirectional Thyristor. It is triggered from a blocking state to a conduction state for either polarity of applied voltage whenever the amplitude of applied voltage exceeds the breakover voltage of the DIAC.

Features & Benefits

- **RoHS** compliant
 - Bilateral triggering device
 - Glass-passivated junctions
 - Wide voltage range selections
 - Long-term reliability
 - Parameter stability
 - Reliable barrier against junction contamination
- ST Series:**
- Epoxy SM package (DO-214)
 - High-temperature, solder bonded die attachment
- HTM/HT Series:**
- MINIMELF/DO-35 trigger package

Applications

DIACs are used to trigger Triacs and SCRs in phase control circuits for lamp dimming, universal motor speed control, and heat control. They are used also for triggering transistors in solid state ballast lighting controls.

Absolute Maximum Ratings

| Symbol | Parameter | Test Conditions | Min | Max | Unit |
|-------------|--------------------------------|-----------------------------------------------------------------------|-----|----------------------------|------------------|
| I_{TRM} | Pulse On-State Current | 120PPS, $T_A \leq 40^\circ\text{C}$ pulse width = 10 μs | | 2 1.5 ^(*) | A |
| T_S | Storage Temperature Range | | -40 | +125 | $^\circ\text{C}$ |
| T_J | Operating Junction Temperature | | -40 | +125 | $^\circ\text{C}$ |
| $P_{D(AV)}$ | Device Power Dissipation | $T_A = -40^\circ\text{C}$ to $+40^\circ\text{C}$ | | See Product Selector Table | mW |

(*)Only Applies to HT-60

Notes:

1. Service Dissipation (at $T_A = -40^\circ\text{C}$ to $+40^\circ\text{C}$): 250mW for DO-35 and MINIMELF/SOD-80 and 300mW for DO214
2. Above $+40^\circ\text{C}$, Derate: 3.6mW/ $^\circ\text{C}$ for DO-35 and MINIMELF/SOD-80 and 3mW/ $^\circ\text{C}$ for DO214

Electrical Characteristics (T_j = 25°C, unless otherwise specified)

| Symbol | Description | Test Conditions | Min | Max | Unit |
|-----------------------|----------------------------------------------------------|----------------------------------------------------|----------------------------|----------------------------|------|
| V _{BO} | Breakover/Trigger Voltage | 50/60Hz Sine Wave | See Product Selector Table | See Product Selector Table | V |
| ΔV _{BO} | Breakover Voltage Symmetry | +V _{BO} to -V _{BO} | | 2 ^(Note 1) | V |
| V _{BB} | Δ Breakback Voltage ^(Note 4) | V _{BO} to V _{10mA} | 5 | | V |
| | | V _{BO} to V _{6mA} ^(*) | 15 | | V |
| V _{BB (DYN)} | Dynamic Δ Breakback Voltage ^(Notes 2 & 3) | 120 PPS | 10 | | V |
| I _{BO} | Breakover Current | 50/60Hz Sine Wave | | 15 | μA |

(*) Only Applies to HT-60

Electrical Characteristic Notes:

1. Breakover voltage symmetry as close as 1V is available from the factory for these products.
2. See Figure 4 and Figure 5 for test circuit and waveforms.

3. Typical switching time is 900 nano-seconds measured at I_{pk} (Figure 4) across a 20 Ω resistor (Figure 5). Switching time is defined as rise time of I_{pk} between the 10% to 90% points

4. See V-I Characteristics
Static Characteristics - Not Applicable

Product Selector

| Part Number | Package Availability | | | V _{BO} | |
|---------------|----------------------|--------|--------|-----------------|-----|
| | MINIMELF | DO-35 | DO-214 | MIN | MAX |
| XX-32 | — | HT-32 | ST-32 | 27V | 37V |
| XX-32A/ 5761 | — | HT-32A | — | 28V | 36V |
| XX-32B/ 5761A | HTM-32B | HT-32B | ST-32B | 30V | 34V |
| XX-34B | — | HT-34B | ST-34B | 32V | 36V |
| XX-35 | — | HT-35 | ST-35 | 30V | 40V |
| XX-36A/ 5762 | — | HT-36A | ST-36A | 32V | 40V |
| XX-36B | — | HT-36B | ST-36B | 34V | 38V |
| XX-40 | — | HT-40 | ST-40 | 35V | 45V |
| XX-60 | — | HT-60 | — | 56V | 70V |

"XX" = HTM for MINIMELF
HT for DO-35
ST for DO-214

Thermal Resistances

| Symbol | Description | Test Conditions | Value | Unit | |
|---------------------|---------------------|--------------------------------|----------|------|------|
| R _{θ(J-L)} | Junction to Lead | Maximum Lead Temperature: 85°C | DO-35 | 100 | °C/W |
| | | Maximum Lead Temperature: 90°C | DO-214 | 65* | °C/W |
| | | Maximum Lead Temperature: 87°C | MINIMELF | 75 | °C/W |
| R _{θ(J-A)} | Junction to Ambient | Free-Air | DO-35 | 278 | °C/W |

* Mounted on 1 cm² copper foil surface; two-ounce copper foil

Figure 1: V-I Characteristics

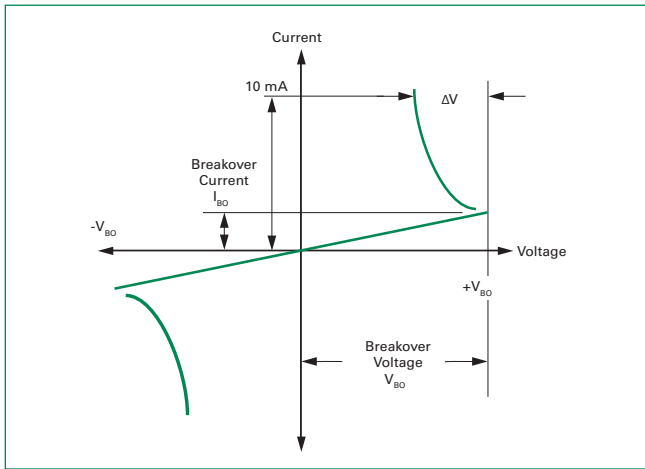

Figure 2: Typical DIAC/Triac Full-wave Phase Control Circuit

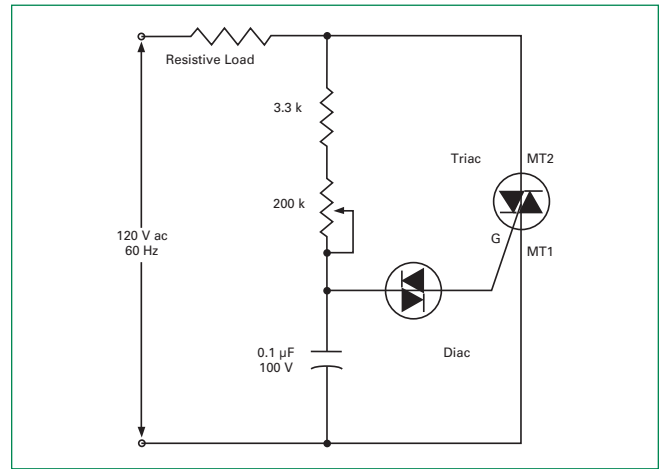

Figure 3: Repetitive Peak On-state Current vs. Pulse Duration

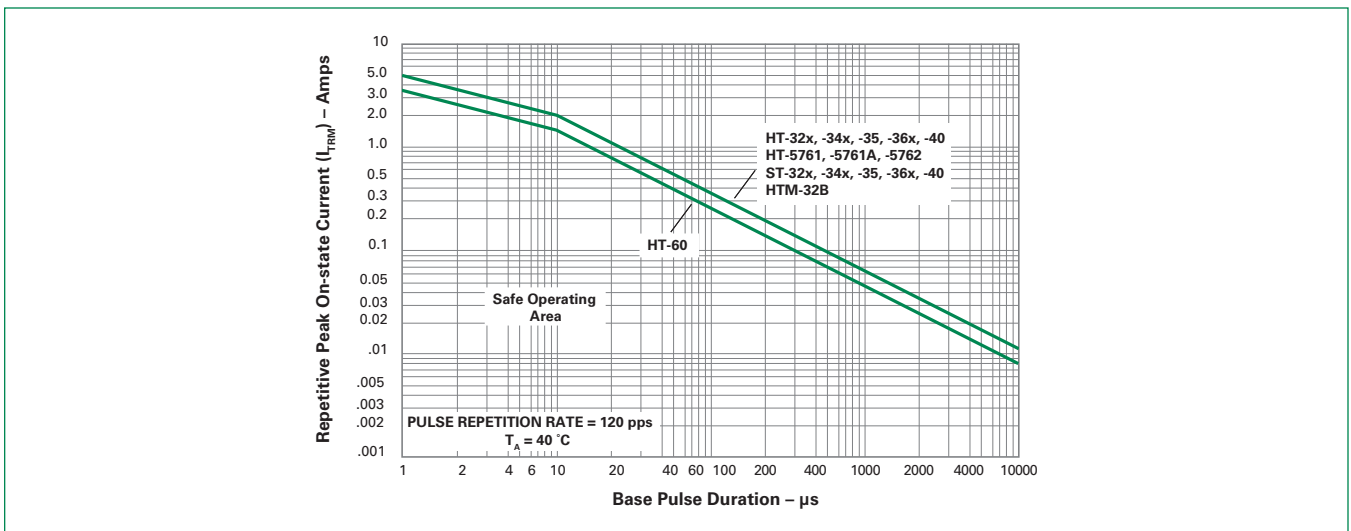

Figure 4: Normalized V_{BO} Change vs. Junction Temperature

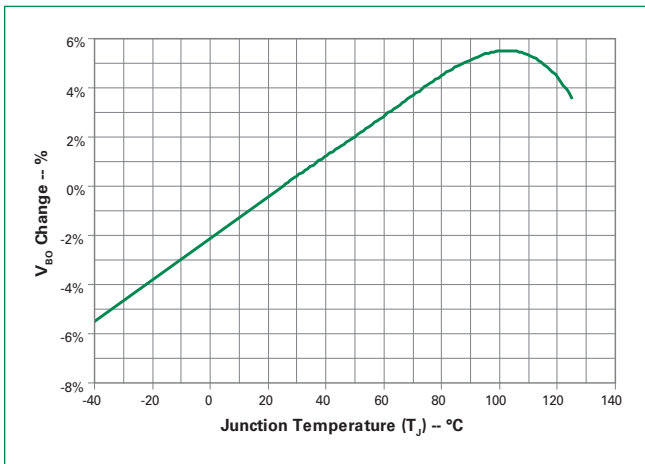
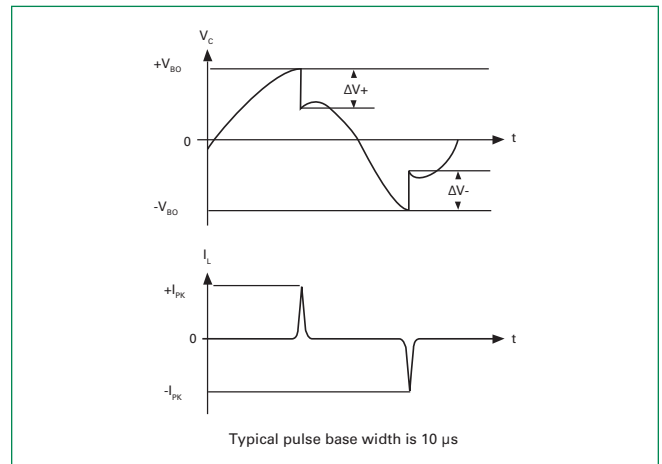

Figure 5: Test Circuit Waveforms (Refer to Figure 5)



DIACs

Figure 6: Circuit Used to Measure DIAC Characteristics (Refer to Figure 4)

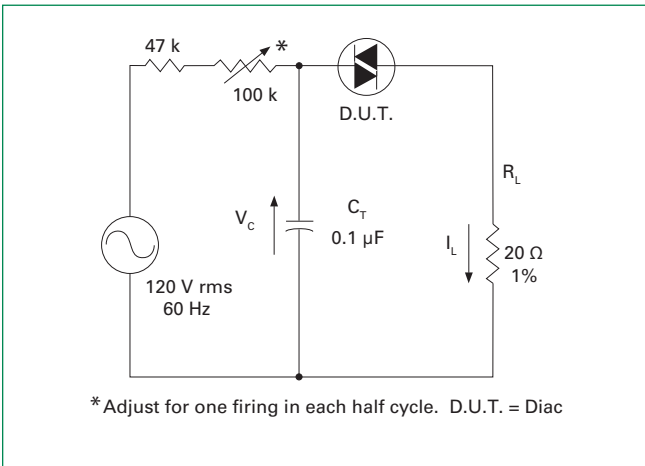
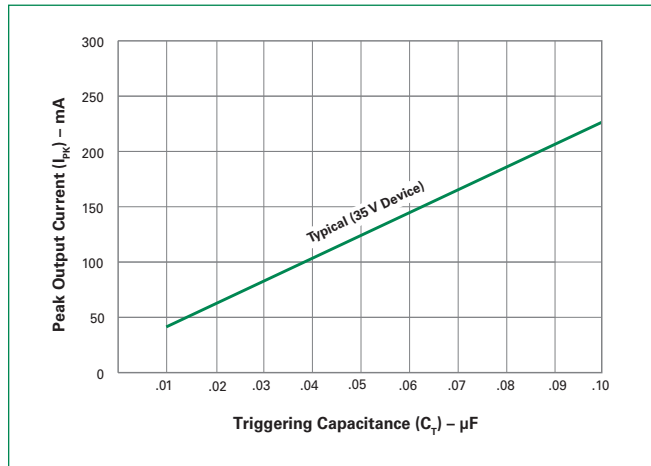
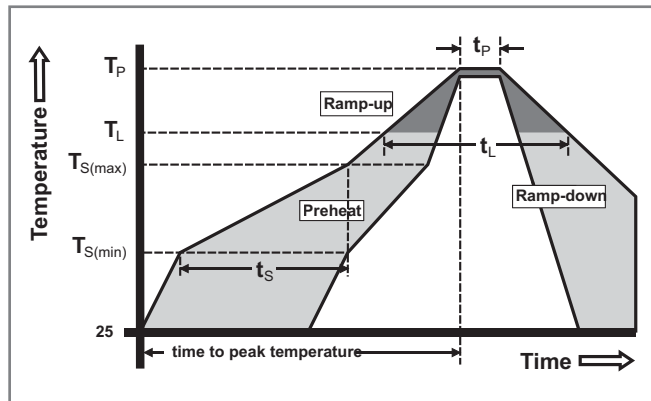

Figure 7: Peak Output Current vs. Triggering Capacitance (Per Figure 5 with R_L of 20 Ω)



Soldering Parameters

| | | |
|--------------------------------------------------------|------------------------------------|--------------------|
| Reflow Condition | | Pb – Free assembly |
| Pre Heat | - Temperature Min ($T_{s(min)}$) | 150°C |
| | - Temperature Max ($T_{s(max)}$) | 200°C |
| | - Time (min to max) (t_s) | 60 – 190 secs |
| Average ramp up rate (Liquidus Temp (T_L) to peak) | | 5°C/second max |
| $T_{s(max)}$ to T_L - Ramp-up Rate | | 5°C/second max |
| Reflow | - Temperature (T_L) (Liquidus) | 217°C |
| | - Time (min to max) (t_s) | 60 – 150 seconds |
| Peak Temperature (T_p) | | 260 °C |
| Time within 5°C of actual peak Temperature (t_p) | | 20 – 40 seconds |
| Ramp-down Rate | | 5°C/second max |
| Time 25°C to peak Temperature (T_p) | | 8 minutes Max. |
| Do not exceed | | 280°C |



Physical Specifications

| | |
|------------------------|-----------------------------------------------------------------------------------------------------------|
| Terminal Finish | 100% Matte-Tin Plated/ Pb-Free Solder Dipped |
| Body Material | DO-214: UL recognized epoxy meeting flammability classification 94V-0. DO-35/MINIMELF: Glass case body |
| Lead Material | DO-214: Copper Alloy DO-35/MINIMELF: Copper Clad Iron |

Design Considerations

Careful selection of the correct device for the application's operating parameters and environment will go a long way toward extending the operating life of the Thyristor. Overheating and surge currents are the main killers of DIACs. Correct mounting, soldering, and forming of the leads also help protect against component damage.

Reliability/Environmental Tests

| Test | Specifications and Conditions |
|------------------------------------------|--------------------------------------------------------------------------------------------------------------------------------------------|
| High Temperature Voltage Blocking | MIL-STD-750, M-1040, Cond A Applied 80% of Rated Min V_{BO} (VAC-peak) @ 125°C for 1008 hours |
| Temperature Cycling | MIL-STD-750, M-1051, 100 cycles; -40°C to +150°C; 15-min dwell-time |
| Temperature/Humidity | EIA / JEDEC, JESD22-A101 1008 hours; 80% of Rated Min V_{BO} (V_{DC}): 85°C; 85% rel humidity |
| High Temp Storage | MIL-STD-750, M-1031, 1008 hours; 150°C |
| Low-Temp Storage | 1008 hours; -40°C |
| Thermal Shock | MIL-STD-750, M-1056 10 cycles; 0°C to 100°C; 5-min dwell time at each temperature; 10 sec (max) transfer time between temperature |
| Autoclave | EIA / JEDEC, JESD22-A102 168 hours (121°C at 2 ATMs) and 100% R/H |
| Resistance to Solder Heat | MIL-STD-750 Method 2031 |
| Solderability | ANSI/J-STD-002, category 3, Test A |
| Lead Bend | MIL-STD-750, M-2036 Cond E |
| Burn-in | 1 firing per 1/2 cycle, 168 hours |

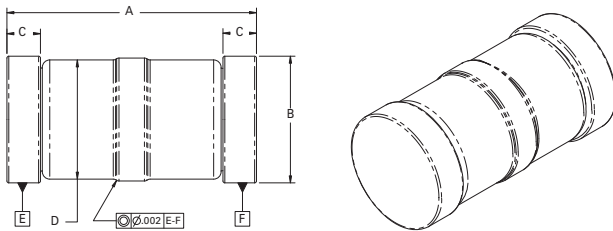
Dimensions – MINIMELF / SOD-80 (MM Package)

| Dimensions | Inches | | | Millimeters | | |
|------------|--------|-------|-------|-------------|------|------|
| | Min | Typ | Max | Min | Typ | Max |
| A | 0.125 | 0.134 | 0.142 | 3.18 | 3.40 | 3.61 |
| B | 0.066 | 0.068 | 0.070 | 1.68 | 1.73 | 1.78 |
| C | 0.012 | 0.018 | 0.020 | 0.30 | 0.46 | 0.51 |
| D | — | 0.063 | — | — | 1.60 | — |

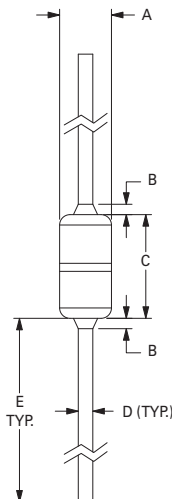
Dimensions – DO-35 (Y Package)

| Dimension | Inches | | Millimeters | |
|------------|--------|-------|-------------|-------|
| | Min | Max | Min | Max |
| A (Note 1) | 0.060 | 0.090 | 1.530 | 2.280 |
| B (Note 2) | | 0.015 | | 0.381 |
| C (Note 1) | 0.135 | 0.165 | 3.430 | 4.190 |
| D | 0.018 | 0.022 | 0.458 | 0.558 |
| E | 1.000 | | 25.400 | |

Notes:

- Package contour optional within dimensions A and C. Slugs, if any, shall be included within this cylinder but shall not be subject to the minimum limit of Dimension A.
- Lead diameter is not controlled in this zone to allow for flash, lead finish build-up and minor irregularities other than slugs.

Dimensions – DO-214 (S Package)

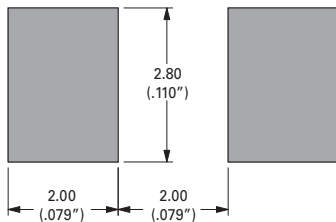
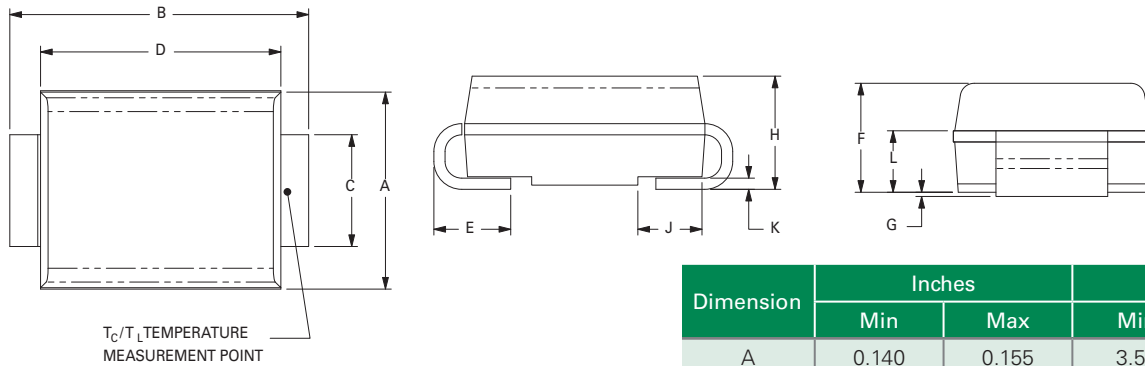

Recommended Soldering Pad Outline
(Reference Only)

| Dimension | Inches | | Millimeters | |
|-----------|--------|-------|-------------|------|
| | Min | Max | Min | Max |
| A | 0.140 | 0.155 | 3.56 | 3.94 |
| B | 0.205 | 0.220 | 5.21 | 5.59 |
| C | 0.077 | 0.083 | 1.96 | 2.11 |
| D | 0.166 | 0.180 | 4.22 | 4.57 |
| E | 0.036 | 0.063 | 0.91 | 1.60 |
| F | 0.066 | 0.083 | 1.67 | 2.11 |
| G | 0.004 | 0.008 | 0.10 | 0.20 |
| H | 0.077 | 0.086 | 1.96 | 2.18 |
| J | 0.043 | 0.053 | 1.09 | 1.35 |
| K | 0.008 | 0.012 | 0.20 | 0.30 |
| L | 0.039 | 0.049 | 0.99 | 1.24 |

Packing Options

| Part Number | Marking | Package | Weight/ Unit | Packing Mode | Base Quantity | Quantity | |
|-------------|---------|----------|--------------|--------------|---------------|----------|------|
| | | | | | | Reel | Box |
| HTM-xxxRP | — | MINIMELF | 0.040g | Tape & Reel | 5000 | 2500 | — |
| HT-xxxRP | — | DO35 | 0.150g | Tape & Reel | 5000 | 5000 | — |
| HT-xxx | — | DO35 | 0.150g | Bulk | 5000 | — | 5000 |
| ST-xxxRP | STxxx | DO214 | 0.075g | Tape & Reel | 2500 | 2500 | — |

DO-214 Embossed Carrier Reel Pack (RP) Specifications

Meets all EIA-481-1 Standards

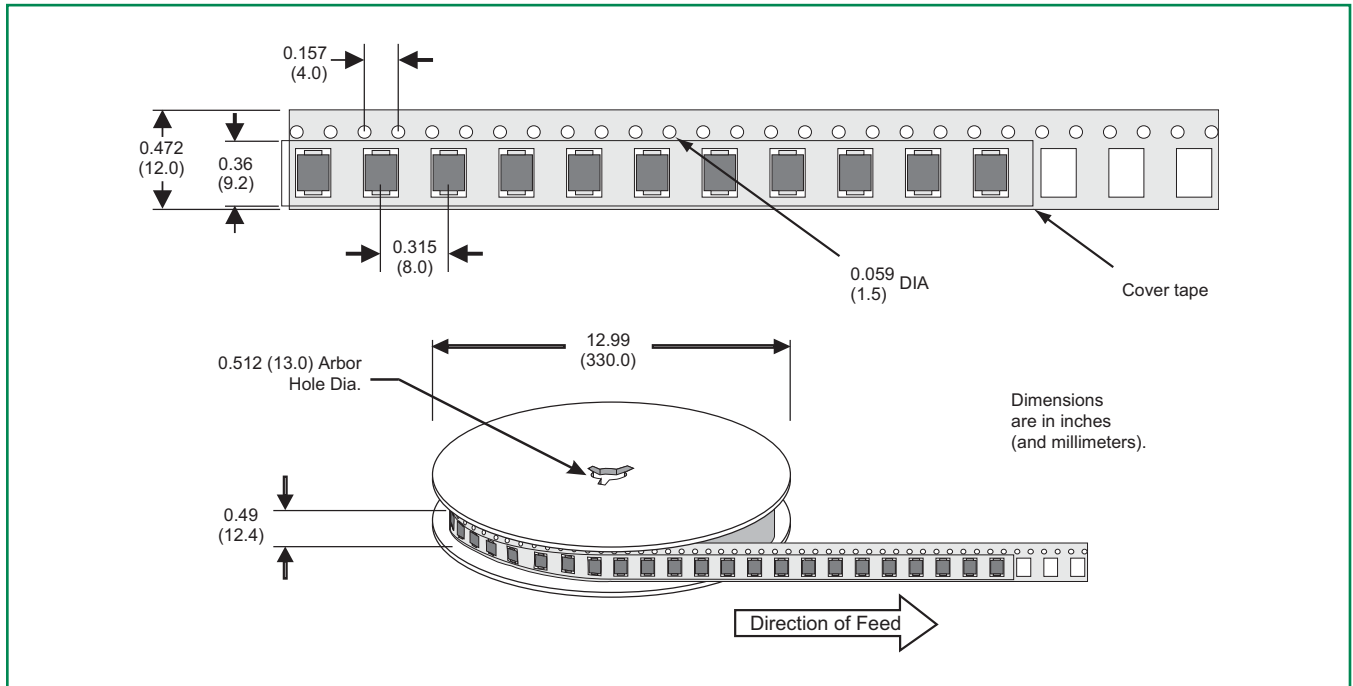

DO-35 Reel Pack (RP) Specifications

Meets all EIA-296 Standards

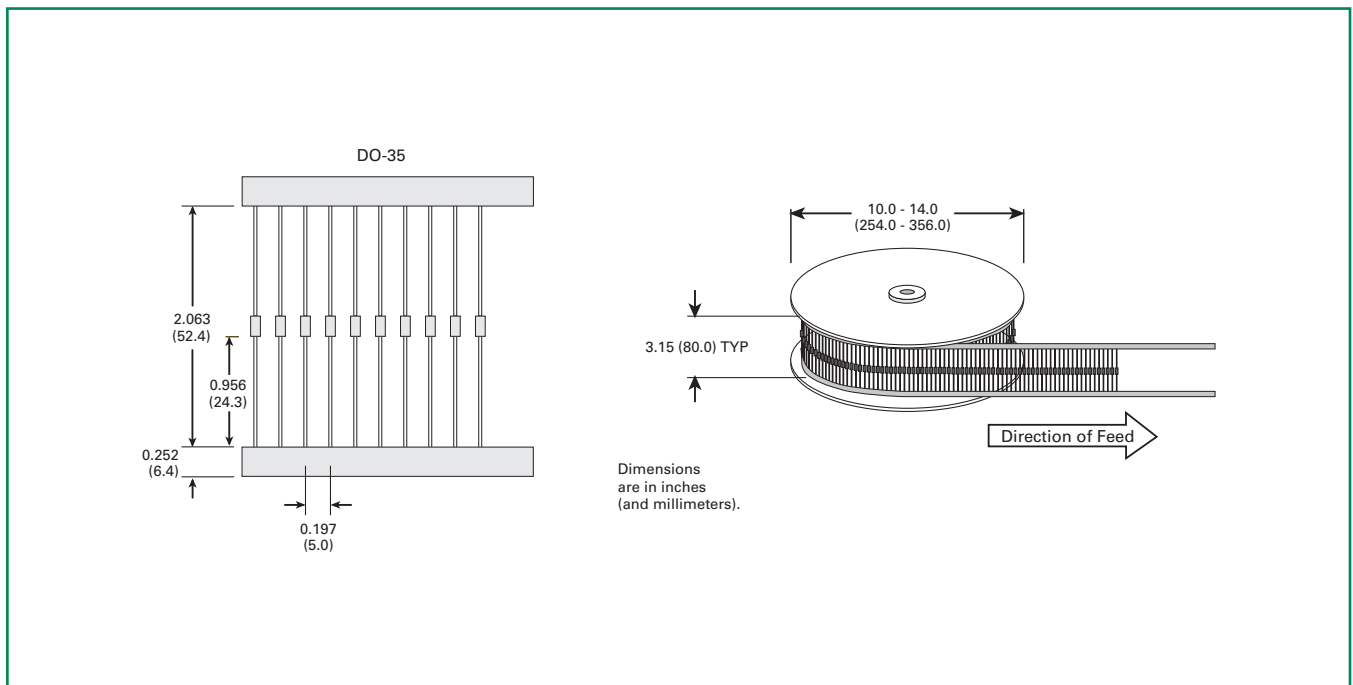

MINIMELF Reel Pack (RP) Specifications

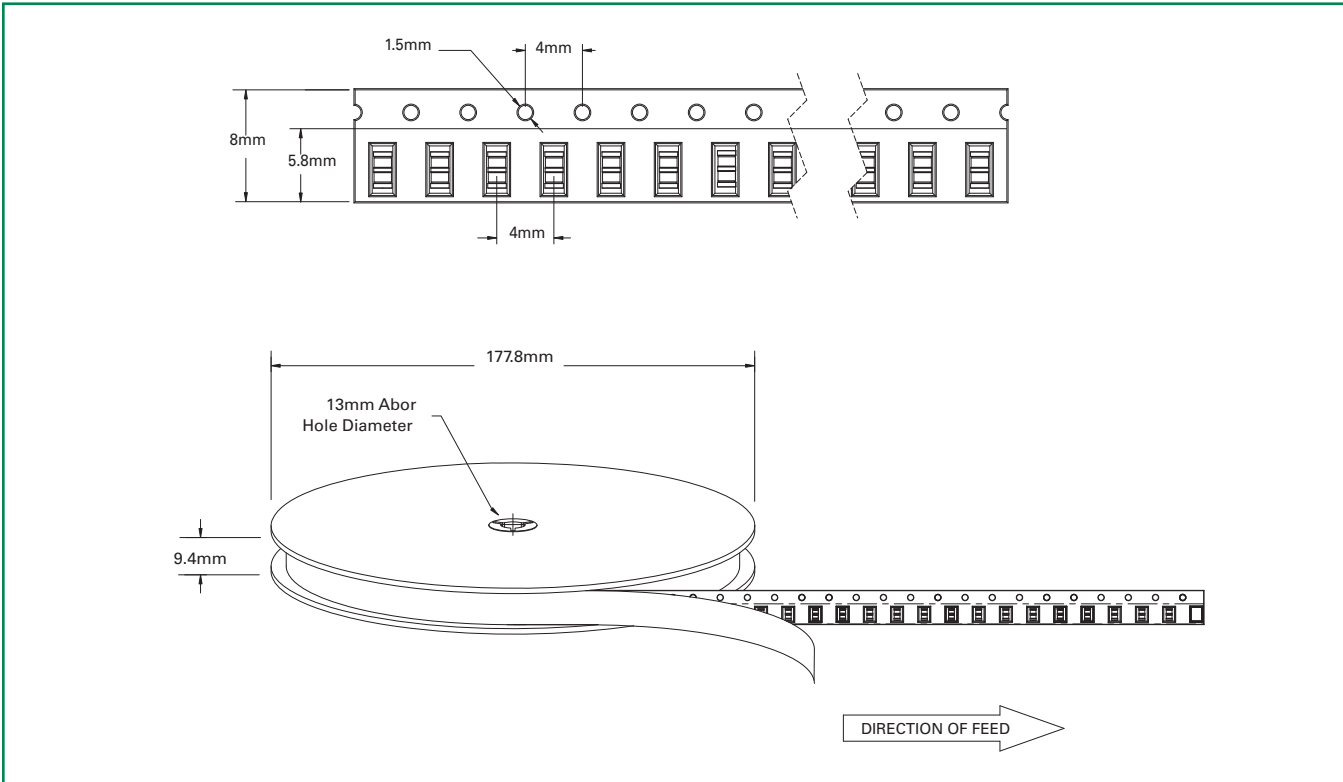

Part Numbering System

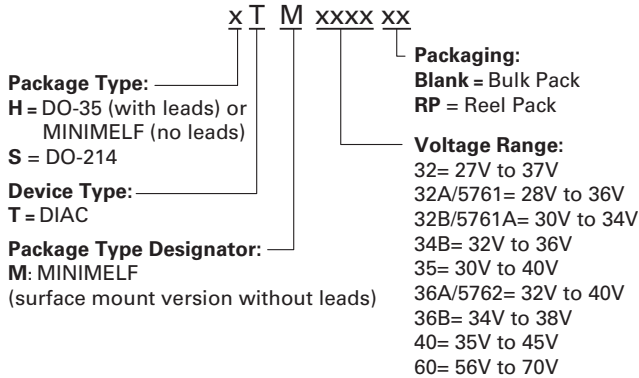

Part Marking System

DO-35 & MINIMELF: No marking

DO-214:

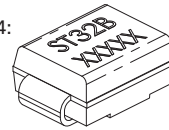

First Line: Part Number
Second Line: Date Code

Компания «Life Electronics» занимается поставками электронных компонентов импортного и отечественного производства от производителей и со складов крупных дистрибьюторов Европы, Америки и Азии.

С конца 2013 года компания активно расширяет линейку поставок компонентов по направлению коаксиальный кабель, кварцевые генераторы и конденсаторы (керамические, пленочные, электролитические), за счёт заключения дистрибьюторских договоров

Мы предлагаем:

- Конкуренеспособные цены и скидки постоянным клиентам.
- Специальные условия для постоянных клиентов.
- Подбор аналогов.
- Поставку компонентов в любых объемах, удовлетворяющих вашим потребностям.
- Приемлемые сроки поставки, возможна ускоренная поставка.
- Доставку товара в любую точку России и стран СНГ.
- Комплексную поставку.
- Работу по проектам и поставку образцов.
- Формирование склада под заказчика.
- Сертификаты соответствия на поставляемую продукцию (по желанию клиента).
- Тестирование поставляемой продукции.
- Поставку компонентов, требующих военную и космическую приемку.
- Входной контроль качества.
- Наличие сертификата ISO.

В составе нашей компании организован Конструкторский отдел, призванный помогать разработчикам, и инженерам.

Конструкторский отдел помогает осуществить:

- Регистрацию проекта у производителя компонентов.
- Техническую поддержку проекта.
- Защиту от снятия компонента с производства.
- Оценку стоимости проекта по компонентам.
- Изготовление тестовой платы монтаж и пусконаладочные работы.



Тел: +7 (812) 336 43 04 (многоканальный)

Email: org@lifeelectronics.ru