

\* Please visit the product pages on our website for the most up-to-date product information

## TINI Q-G® MINIATURE CONNECTORS

- Series TA(\*)F, TA(\*)FB, TA(\*)FL and TA(\*)FLB – Straight female cord plug
- Series TA(\*)M, TA(\*)MB, TA(\*)ML and TA(\*)MLB – Straight male cord plug
- Series TB(\*)M and TB(\*)MB – Chassis/panel mount male receptacle
- Series TY(\*)F and TY(\*)FPC – Chassis/panel, female receptacle, choice of solder lugs or P.C. terminations.
- Series TLP – Looping Plugs
- Series TBA(\* \*) – Audio Adapters
- Series TRA(\*)M – PC Mount Male Receptacles
- Series TRG(\*) – Reverse Gender Panel Mount, Cord Mount

### DESIGN FEATURES

**STYLE** – Streamlined, miniaturized with nickel-plated metal and contrasting black plastic parts. Designed for light weight and unobtrusiveness. Also available in conductive black chrome finish.

**CONSTRUCTION** – Metal parts are rugged die-cast or precision machined with nickel-plating; plastic parts are molded of high dimensional-stability thermoplastic. Advanced design assures minimum weight consistent with strength and durability of cord plug housings of .413" (10.5 mm) diameter. Weight: Series TA(\*)F plug = .25 ounce (7 g); Series TA(\*)M = .3 ounce (8.5 g).

**INSERTS** – Precision molded of thermoplastic for high mechanical and dielectric strength. Contacts and terminals are precision formed and plated for intimate contact and low resistance connections. Terminal numbers are molded on rear of male insert and on face of female insert for easy identification (except 6-pin male insert). Inserts can be supplied for OEM installation in microphones and instrumentation for optimum connecting reliability. For cord plugs, inserts can also be supplied for replacements.

**LATCHLOCK** – Positive latch system assures high integrity, vibration-resistant mating and transfer of shielding connection between housing, combined with simple, easy fingertip release.

**STRAIN RELIEF** – Rugged internal clamp holds cable tightly, while making a secure, low resistance connection between cable shield and housing.



**FLEX RELIEF** – Protects by minimizing cable bending stress at point of cable entry. Maximum recommended cable diameter is .115" (2.92 mm) when flex relief is used. By omitting flex relief (Series T(\*)FL and T(\*)ML only), cable up to .170" (4.32 mm) diameter can be used.

**ASSEMBLY** – Connector parts are mechanically keyed for simple assembly.

**POLARIZATION** – Mating male and female connectors are also mechanically keyed (latch and groove) so that it is impossible to mate them incorrectly.

**“SCOOP-PROOF” FEATURE** – Fully recessed pins on male plugs and receptacles cannot be “scooped”, bent or damaged by accidental mismating with mating connector.

**COLOR ESCUTCHEONS** – Attractive color escutcheons, Series TYEF, are recommended for use with Series TY(\*)F and TY(\*)FPC receptacles (when rear mounted) for attractive panel trim, as well as color coding one or more connectors. Colors are: red, black, gray, green, blue, white and yellow.

**CUSTOM Tini Q-G® CABLE ASSEMBLIES** – On special order where production quantities warrant, Switchcraft can supply assembled and tested Tini Q-G® cables.

### MOUNTING

#### Panel/Chassis Thickness:

Series TB(\*)M: .25" (6.35 mm) maximum

#### Series TY(\*)F:

Front—.375" (9.5 mm) maximum

Rear—.093" (2.3 mm) maximum

#### Series TY(\*)FPC:

Front—.312" (7.9 mm) maximum

Rear—.093" (2.3 mm) maximum

## TINI Q-G® AUDIO ADAPTERS

Series TA Tini Q-G® audio adapters have been designed to adapt Tini Q-G® connections to standard audio connectors. Tini Q-G® adapters convert to Switchcraft Q-G® and QGP connectors and similar full-size connectors.

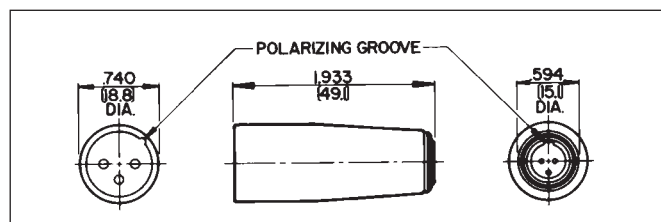
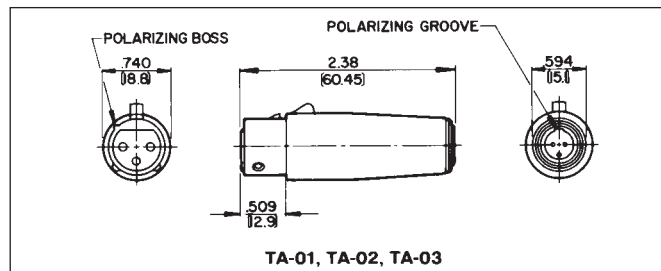

Part Number	Tini Q-G® End Mates With	Q-G® End Mates With
◇TA01	TA3F	A3M
◇TA02	TA4F	A4M
◇TA03	TA5F	A5M
◇TA04	TA3F	A3F
◇TA05	TA4F	A4F
◇TA06	TA5F	A5F

DIMENSIONS ARE FOR REFERENCE ONLY Inch  
(mm)

\* Please visit the product pages on our website for the most up-to-date product information

TINI Q-G® MINIATURE CONNECTORS (continued) 

**SPECIFICATIONS: (3 – 5 CORD MOUNT ONLY)**

**ELECTRICAL**

**Contact Resistance:** .010 ohms maximum after life (and after salt spray).

**Current Rating (Carry Only):** 5 A, 125 V AC (4 A, 125 V AC on 5 circuit) based on 30°C maximum.

**Insulation Resistance:** 510,000 megohms minimum @ 500 V DC (initial); 10,000 megohms minimum (after humidity test).

**Dielectric Strength:** 1,000 V (rms).

**MECHANICAL**

**Life:** 5,000 operations minimum

**Insertion/Withdrawal Forces (after life):** 6.1 lb./2.77 kg after life, insertion; 5.6 lb/2.54 kg, withdrawal.

**Solderability Standard:** Meets EIA RS-186-9E.

**Mechanical Shock:** Meets MIL-STD-202, method 213B.

**Vibration:** Meets MIL-STD-202, method 201A.

**Wire Size:** #22 wire gauge solid; #24 wire gauge stranded.

**ENVIRONMENTAL**

**Thermal Range:** -55°C to + 85°C.

**Humidity:** Meets MIL-STD-202, method 106D.

**Thermal Shock:** Meets MIL-STD-202, method 107D.

**Salt Spray:** Meets MIL-STD-202, method 101.

**MATERIAL**

**Housing, Plugs and Male Receptacles:** Copper alloy, nickel-plated. Female Receptacle—Die-cast zinc, nickel-plated.

**Black Tini Q-G® Housing:** Copper alloy, black chrome-plated.

**Pin and Socket Contacts:** Copper alloy, silver-plated.

**Flex Relief:** Molded black thermoplastic elastomer.

**Latch Button:** Molded black thermoplastic.

**Release Lever and Mounting Washer:** Steel, nickel-plated.

**Standoff/Ground Terminal and Cable Clamp:**

Steel, electroplated.

**Inserts and Insulating Spacer:** Molded, high strength thermoplastic.

**Latch (Female):** Copper alloy, nickel-plated.

**Mounting Nut:** Copper alloy, nickel-plated.

**SPECIFICATIONS:**

**(6 – 8 Cord Mount and all Receptacles and Adapters)**

**ELECTRICAL**

**Contact Resistance:** .010 ohm maximum after life.

**Current Rating (Carry only):** 1.5A, 125 VAC, based on 30° maximum

**Insulation Resistance:** 510,000 MΩ minimum @ 500 VDC (initial).

**Dielectric Strength:** 250 V rms.

**MECHANICAL**

**Life:** 2,000 operations

**Insertion/Withdrawal Forces (after life):** -13 pound insertion; -13 pound maximum withdrawal

**Solderability Standard:** Meets EIA RS-186-9E.

**Wire Size:** 28 wire gauge stranded.

**MATERIAL**

**Housings, Plugs and Male Receptacles:** Copper alloy, nickel-plated.

**Socket Contacts:** Copper alloy, silver-plated.

**Pin Contacts:** Copper alloy, electroplated.

**Flex Relief and Latch Button:** Molded thermoplastic.

**Ground Terminal:** Copper alloy, electroplated.

**Inserts and Insulating Spacer:** Molded high strength thermoplastic, UL 94 V-0.

**Latch (Female):** Copper alloy, nickel-plated.

**Mounting Nut:** Copper alloy, nickel-plated.

**Ferrite:** 43 material, shielded head.

**Frame:** Molded thermoplastic, UL 94 V-0.

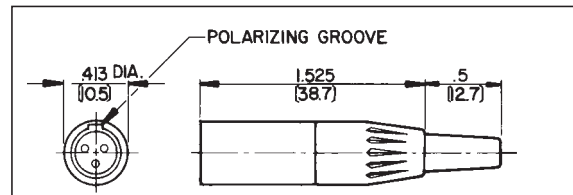
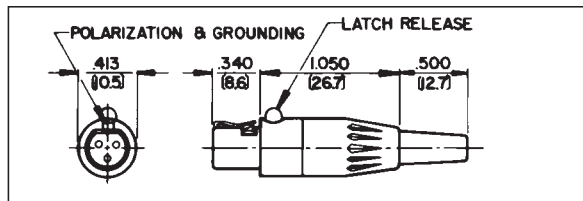

**STRAIGHT FEMALE CORD PLUG**

Part Number	Insert Contacts	Part Number	Insert Contacts <sup>2</sup>
TA3F	3	TA4FLB <sup>*</sup>	4
TA3FB <sup>*</sup>	3	TA5F	5
TA3FL <sup>1</sup>	3	TA5FL <sup>1</sup>	5
TA3FLB <sup>*</sup>	3	TA5FLB <sup>*</sup>	5
TA4F	4	TA6FL <sup>1</sup>	6
TA4FB <sup>*</sup>	4	TA7FL	7
TA4FL <sup>1</sup>	4	TA8FL	8

1 Flex relief omitted for larger diameter cable

2. Add AU to Part Number for Gold Contacts.

\* B indicates black housing

**STRAIGHT MALE CORD PLUG**

Part Number	Insert Pins	Part Number	Insert Pins
TA3M	3	TA5M	5
TA3MB <sup>*</sup>	3	TA5ML	5
TA3ML	3	TA5MLB <sup>*</sup>	5
TA4M	4	TA6ML <sup>1</sup>	6
TA4MB <sup>*</sup>	4	TA7ML	7
TA4ML <sup>1</sup>	4	TA8ML	7

1. Add AU to Part Number for Gold Contacts.

\* B indicates black housing

◇ Available on special order only; contact Switchcraft for price and delivery.

DIMENSIONS ARE FOR REFERENCE ONLY Inch  
(mm)

\* Please visit the product pages on our website for the most up-to-date product information

TINI Q-G® MINIATURE CONNECTORS (continued) 

CONNECTORS & RECEPTACLES Switchcraft®

**TB(\*)M AND TB(\*)MB RECEPTACLE**



Male receptacle for chassis/panel mounting. Specially designed flange permits close (front) mount on crowded panels. Mounting hardware supplied. Available with PC terminals. Call factory for details.

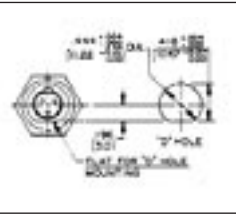
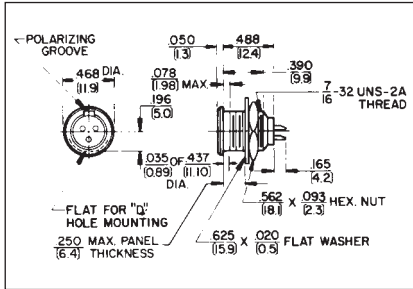

Part Number	Insert Pins	Part Number	Insert Pins
TB3M	3	TB5MB*	5
TB3MB*	3	TB6M	6
TB4M	4	TB7M	7
TB4MB*	4	TB8M	8
TB5M	5		

**TLP(\*) LOOPING PLUG**



Looping plug is designed for circuit testing. Other inserts and wiring patterns are possible; contact Switchcraft.

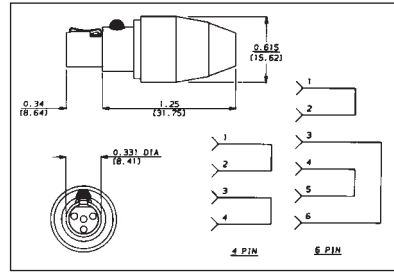

**STRAIGHT FEMALE LOOPING PLUG**

Part Number	Insert Contacts
◇TLP4	4
◇TLP6	6

\* B indicates black housing

◇ Available on special order only; contact Switchcraft for price and delivery.

\* Number of insert contacts or pins must be specified to complete Part Number.



TRG4M

**REVERSE GENDER TQG SERIES**

Same specifications as the original TQG Series, however, the latch is on the male cord mount. Available in 4 pin only.



TRGS4F

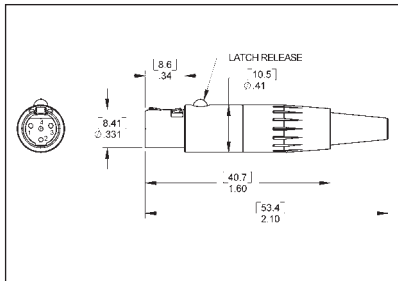

Part Number	Insert Pins	Description
TRGS4F	4	Panel mount female
TRG4M	4	Cord mount male w/latch

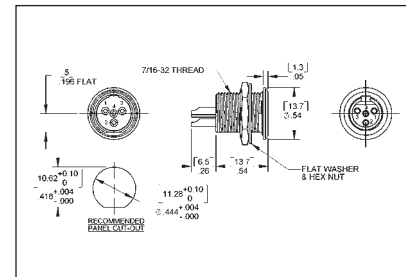

DIMENSIONS ARE FOR REFERENCE ONLY  $\frac{\text{Inch}}{\text{(mm)}}$

\* Please visit the product pages on our website for the most up-to-date product information

TINI Q-G® MINIATURE CONNECTORS (continued)

TRA(\*M) PC MOUNT MALE RECEPTACLE

The TRA(\*M) low profile male receptacles mount in minimum space from the rear of panel or chassis, and feature space-saving right-angle construction and PC type terminals. The TRA3M is a cost-effective choice for audio equipment, medical instrumentation, computer equipment and test/measurement applications. Also available with 6 pins.

TRA3M



TRA6M



Part Number	Insert Pins
TRA3M	3
TRA6M	6
TRA6MF*	6

\*F designates ferrite shielding.

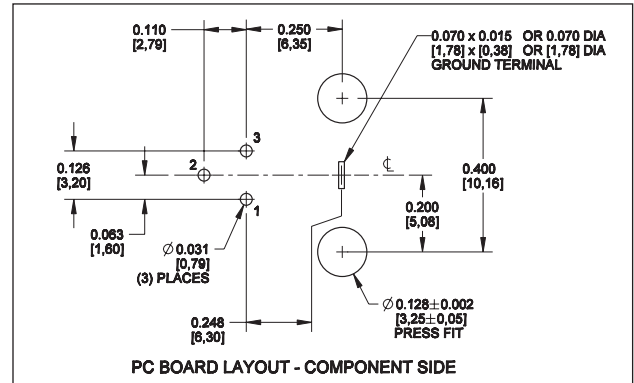
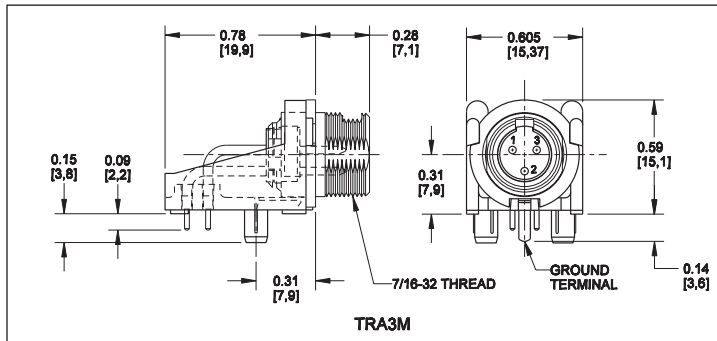

TRASM\*M, TRAPC\*M SERIES

Switchcraft introduces an expansion of its popular TQG Series of connectors. The TRASM\*M and TRAPC\*M offers low profile, right angle PC board mount connectors. The TRASM\*M versions are true surface mount connectors, while the TRAPC\*M versions are through-hole PC mount connectors. Both versions are available in 3-8 pins. All plastic connectors, the TRASM\*M and TRAPC\*M series have flats on the top of the connectors to facilitate pick and place assembly. As an added option, a non-threaded bushing version is also available.

FEATURES AND BENEFITS

- Low profile, compact design reduces PC board space
- Mates with TQG female cord plugs
- Rated at 5A for 3-6 pins, 3A for 7 and 8 pin versions

MARKETS

- Wireless microphone systems
- Medical Instrumentation
- Test Instrumentation

SPECIFICATIONS

MATERIALS

- Housing: Thermoplastic
- Contacts: Brass, tin-plated
- Nut and Washer: Brass, nickel-plated

TRASM3M



TRAPC3MS

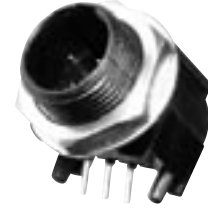

ELECTRICAL

- Current Rating: 5A for 3-5 pins, 1.5A for 6-8
- Contact Resistance: 10 m Ohm max
- Insulation Resistance: 100 m Ohm min
- Dielectric Withstanding Voltage: 250VAC
- Mechanical Life: 2,000 cycles

TINI Q-G® CONNECTORS ORDERING INFORMATION

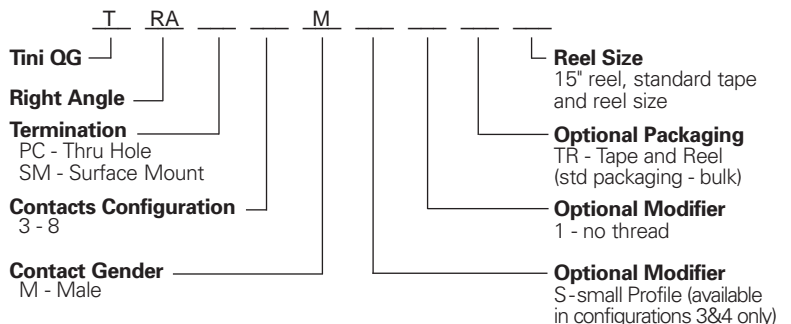

See next pages for drawings

DIMENSIONS ARE FOR REFERENCE ONLY Inch (mm)

Switchcraft® CONNECTORS & RECEPTACLES

\* Please visit the product pages on our website for the most up-to-date product information

TINI Q-G® MINIATURE CONNECTORS (continued)

TRASM\*M, TRAPC\*M SERIES

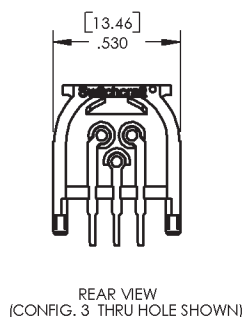
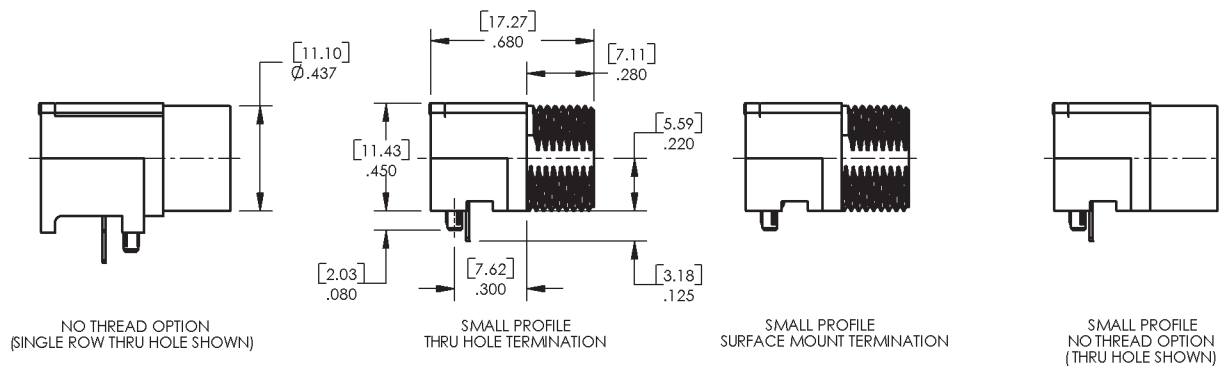
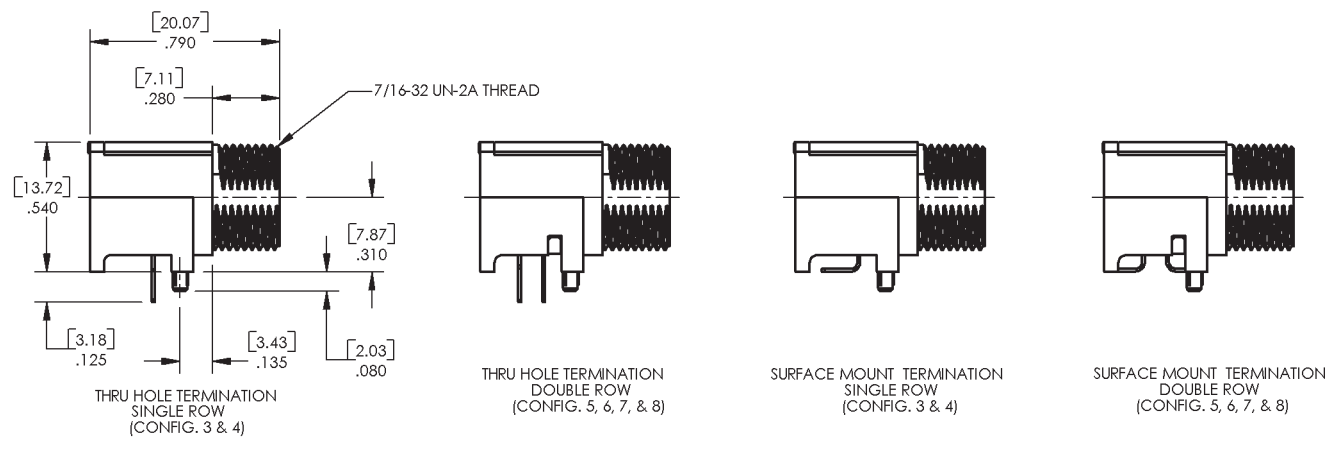
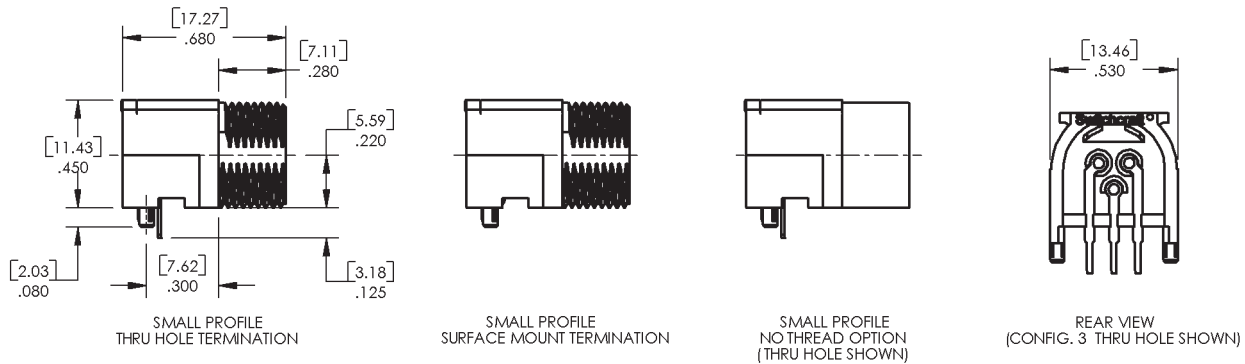

DIMENSIONS ARE FOR REFERENCE ONLY  $\frac{\text{Inch}}{\text{(mm)}}$

\* Please visit the product pages on our website for the most up-to-date product information

TINI Q-G® MINIATURE CONNECTORS (continued)

TRASM\*M, TRAPC\*M SERIES

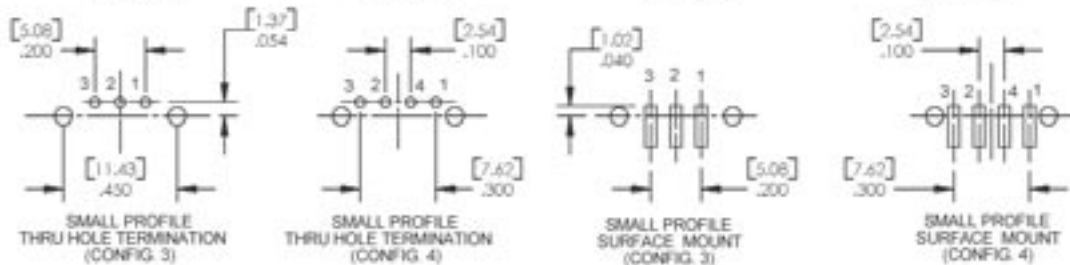
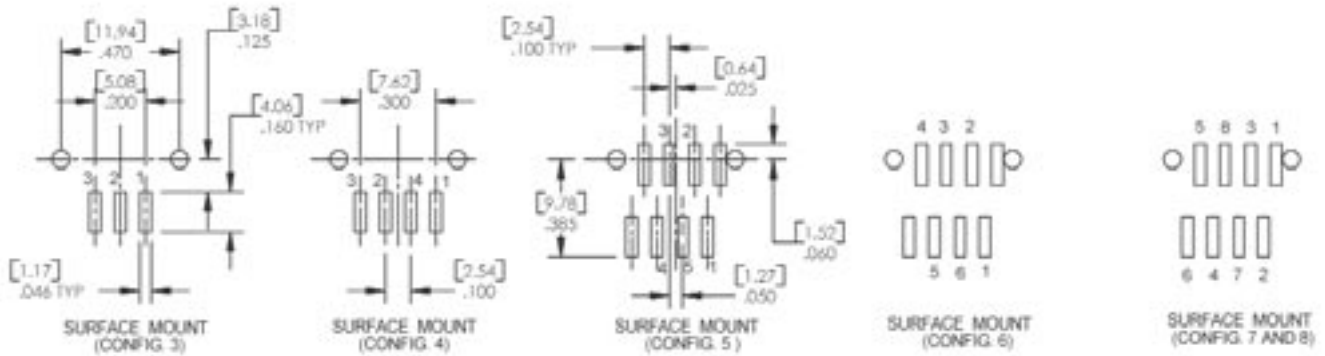
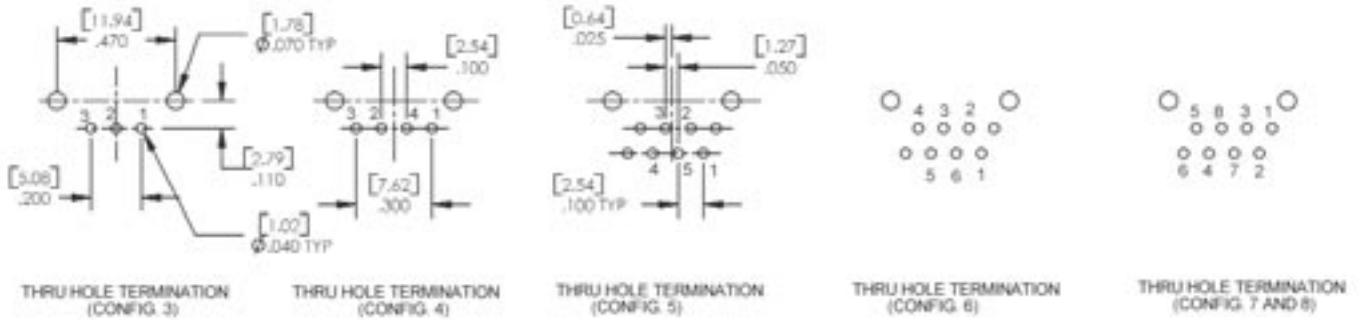
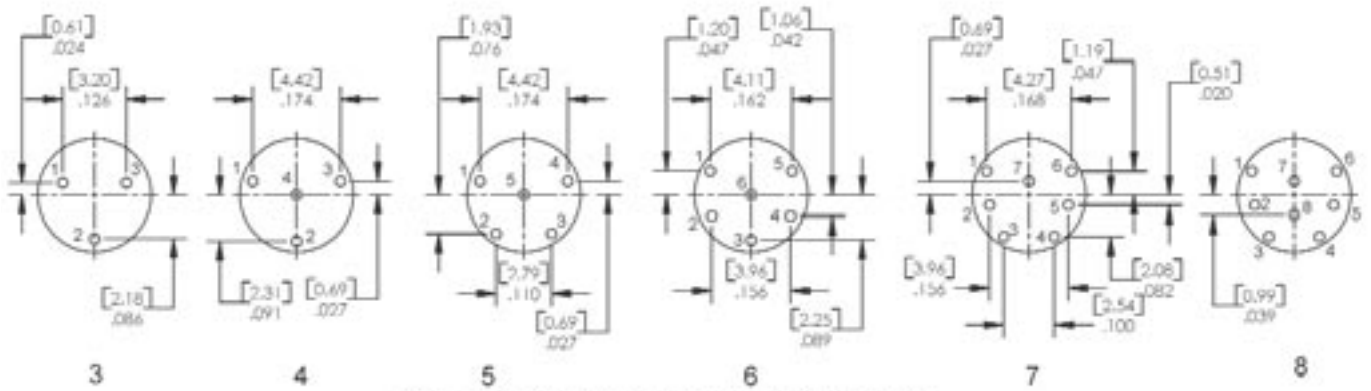

RECOMMENDED PC BOARD LAYOUTS

DIMENSIONS ARE FOR REFERENCE ONLY Inch (mm)

\* Please visit the product pages on our website for the most up-to-date product information

TINI Q-G® MINIATURE CONNECTORS (continued) 

TY(\*)F AND TY(\*)FPC RECEPTACLES

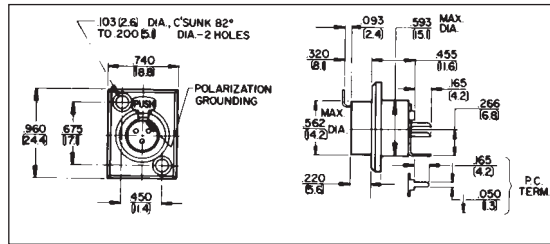

Female receptacle mounts in minimum space from front or rear panel or chassis. Terminals are solder lugs, Series TY(\*)F, or P.C., Series TY(\*)FPC. All receptacles have separate ground lug.

Part Number	Insert Contacts	Part Number	Insert Contacts
TY3F	3	TY5F	5
TY3FPC	3	TY5FPC	5
TY4F	4		
TY4FPC	4		

MOUNTING HOLE DETAIL  
SERIES TY(\*)F, TY(\*)FPC

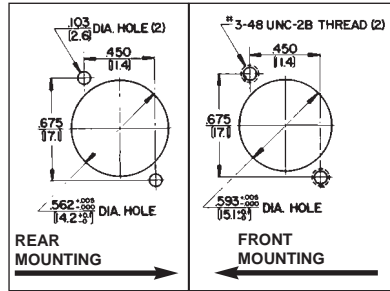

COMBINED P.C./PANEL MOUNTING

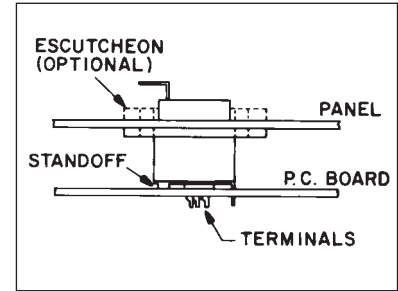

RECOMMENDED P.C. BOARD LAYOUT

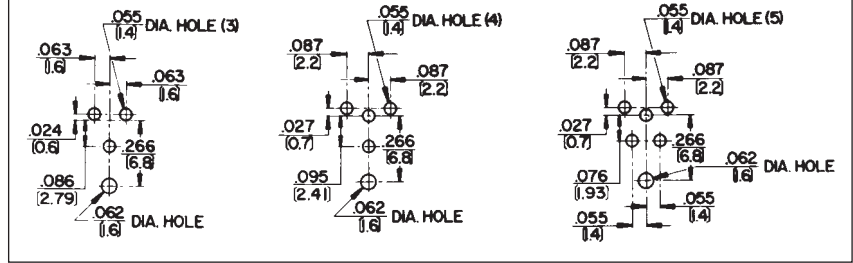

TYEF ESCUTCHEONS

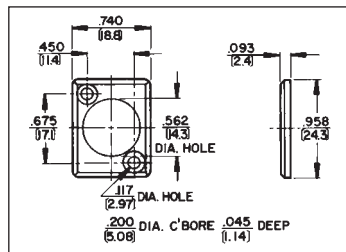
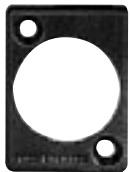

Trim escutcheons in seven colors for use with Series TY(\*)F and TY(\*)FPC receptacles, are recommended for rear mount receptacles. Escutcheons must be ordered separately.

Part Number	Color
◇TYEF01	Red
TYEF02	Black
◇TYEF03	Green
◇TYEF04	Blue
◇TYEF05	White
◇TYEF08	Yellow
◇TYEF11	Gray

TQG(\*)F AND TQG(\*)M  
CONNECTOR INSERTS



Male and female inserts with 3, 4, 5 or 6 pins/ contacts. For replacement (cord plugs only) or build-into equipment, such as microphones, transducers and instruments.

Male Inserts

Part Number	Insert Pins
TQG3M	3
TQG4M	4
TQG5M	5
◇TQG6M	6

Female Inserts

Part Number	Insert Contacts
TQG3F	3
TQG4F	4
TQG5F	5
◇TQG6F	6

TBA(\*\*) AUDIO ADAPTER

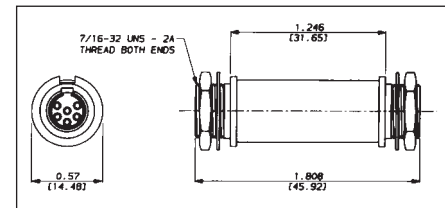

3-6 pin male-to-male adapter is designed for through-bulkhead or cable expansion usage. Adapter is prewired pin 1 to pin 1, pin 2 to pin 2, etc. Mounting nuts are supplied for each threaded end. Panel hole diameter required is .45"; maximum panel thickness is .25" (6.35 mm).

Part Number	Insert Pins
◇TBA03	3
◇TBA04	4
◇TBA05	5
◇TBA06	6

◇ Available on special order only; contact Switchcraft for price and delivery.

DIMENSIONS ARE FOR REFERENCE ONLY Inch  
(mm)

Компания «Life Electronics» занимается поставками электронных компонентов импортного и отечественного производства от производителей и со складов крупных дистрибьюторов Европы, Америки и Азии.

С конца 2013 года компания активно расширяет линейку поставок компонентов по направлению коаксиальный кабель, кварцевые генераторы и конденсаторы (керамические, пленочные, электролитические), за счёт заключения дистрибьюторских договоров

Мы предлагаем:

- Конкуренспособные цены и скидки постоянным клиентам.
- Специальные условия для постоянных клиентов.
- Подбор аналогов.
- Поставку компонентов в любых объемах, удовлетворяющих вашим потребностям.
- Приемлемые сроки поставки, возможна ускоренная поставка.
- Доставку товара в любую точку России и стран СНГ.
- Комплексную поставку.
- Работу по проектам и поставку образцов.
- Формирование склада под заказчика.
- Сертификаты соответствия на поставляемую продукцию (по желанию клиента).
- Тестирование поставляемой продукции.
- Поставку компонентов, требующих военную и космическую приемку.
- Входной контроль качества.
- Наличие сертификата ISO.

В составе нашей компании организован Конструкторский отдел, призванный помогать разработчикам, и инженерам.

Конструкторский отдел помогает осуществить:

- Регистрацию проекта у производителя компонентов.
- Техническую поддержку проекта.
- Защиту от снятия компонента с производства.
- Оценку стоимости проекта по компонентам.
- Изготовление тестовой платы монтаж и пусконаладочные работы.



Тел: +7 (812) 336 43 04 (многоканальный)

Email: [org@lifeelectronics.ru](mailto:org@lifeelectronics.ru)