

FEATURES

- Maximum carrying current of 35A made possible through using the same size as the company's CT relays
- Plastic sealed type

TYPICAL APPLICATIONS

- Power windows
- Auto door lock
- Power sunroof
- Powered seats
- Slide door closers, etc. (for DC motor forward/reverse control circuits)

ORDERING INFORMATION

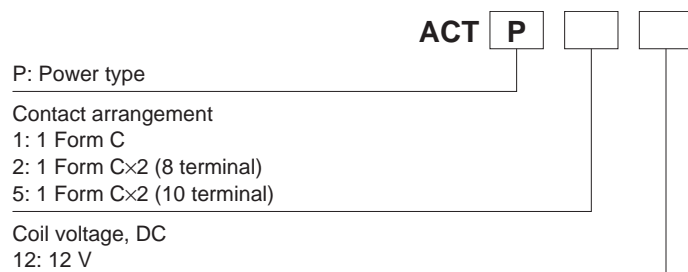

TYPES

Contact arrangement	Coil voltage	Part No.
1 Form C	12 V DC	ACTP112
1 Form C × 2 (8 terminals type)		ACTP212
1 Form C × 2 (10 terminals type)		ACTP512

Standard packing; 1 Form C: Carton (tube) 30pcs. Case 1,500pcs.; 1 Form C × 2: Carton (tube) 30pcs. Case 900pcs.

RATING

1. Coil data

Nominal coil voltage	Pick-up voltage (at 20°C 68°F)	Drop-out voltage (at 20°C 68°F)	Nominal operating current [±10%] (at 20°C 68°F)	Coil resistance [±10%] (at 20°C 68°F)	Nominal operating power (at 20°C 68°F)	Usable voltage range
12V DC	Max. 7.2 V DC (Initial)	Min. 1.0 V DC (Initial)	83.3 mA	144Ω	1,000 mW	10 to 16V DC

Note: Other pick-up voltage types are also available. Please contact us for details.

CT (ACTP)

2. Specifications

Characteristics	Item	Specifications	
Contact	Arrangement	1 Form C × 2, 1 Form C	
	Contact resistance (Initial)	N.O.: Typ 7mΩ, N.C.: Typ 10mΩ (By voltage drop 6V DC 1A)	
	Contact material	Ag alloy (Cadmium free)	
Rating	Nominal switching capacity (resistive load)	N.O.: 30 A 14V DC, N.C.: 10 A 14V DC	
	Max. carrying current (14V DC)*3	N.O.: 40 A for 2 minutes, 25 A for 1 hour at 20°C 68°F, 35 A for 2 minutes, 20 A for 1 hour at 85°C 185°F	
	Nominal operating power	1,000 mW	
	Min. switching capacity (resistive load)*1	1 A 14V DC	
Electrical characteristics	Insulation resistance (Initial)	Min. 100 MΩ (at 500V DC, Measurement at same location as "Breakdown voltage" section.)	
	Breakdown voltage (Initial)	Between open contacts	500 Vrms for 1 min. (Detection current: 10mA)
		Between contacts and coil	500 Vrms for 1 min. (Detection current: 10mA)
	Operate time (at nominal voltage)	Max. 10ms (at 20°C 68°F, excluding contact bounce time) (Initial)	
Release time (at nominal voltage)	Max. 10ms (at 20°C 68°F, excluding contact bounce time) (Initial)		
Mechanical characteristics	Shock resistance	Functional	Min. 100 m/s ² {10G} (Half-wave pulse of sine wave: 11ms; detection time: 10μs)
		Destructive	Min. 1,000 m/s ² {100G} (Half-wave pulse of sine wave: 6ms)
	Vibration resistance	Functional	10 Hz to 100 Hz, Min. 44.1 m/s ² {4.5G} (Detection time: 10μs)
		Destructive	10 Hz to 500 Hz, Min. 44.1 m/s ² {4.5G}, Time of vibration for each direction; X, Y direction: 2 hours, Z direction: 4 hours
Expected life	Mechanical	Min. 10 ⁷ (at 120 cpm)	
	Electrical	<Resistive load> Min. 5 × 10 ⁴ (at nominal switching capacity, operating frequency: 1s ON, 9s OFF) <Motor load> N.O. side: Min. 10 ⁵ (at Inrush 30A, Steady 7A 14 V DC), Min. 5 × 10 ⁴ (at 30A 14 V DC motor lock condition) N.C. side: Min. 10 ⁵ (at brake current 15A 14 V DC) (operating frequency: 0.5s ON, 9.5s OFF)	
Conditions	Conditions for operation, transport and storage*2	Ambient temperature: -40°C to +85°C -40°F to +185°F, Humidity: 5% R.H. to 85% R.H. (Not freezing and condensing at low temperature)	
	Max. operating speed	6 cpm (at nominal switching capacity)	
Mass		Twin type: approx. 8 g .28 oz, 1 Form C type: approx. 4 g .14 oz	

Notes:

*1. This value can change due to the switching frequency, environmental conditions, and desired reliability level, therefore it is recommended to check this with the actual load.

*2. The upper operation ambient temperature limit is the maximum temperature that can satisfy the coil temperature rise value. Refer to "6. Usage, Storage and Transport Conditions" in [AMBIENT ENVIRONMENT section in Relay Technical Information](#).

Please inquire if you will be using the relay in a high temperature atmosphere (110°C 230°F).

*3. Depends on connection conditions. Also, this does not guarantee repeated switching. We recommend that you confirm operation under actual conditions.

* If the relay is used continuously for long periods of time with coils on both sides in an energized condition, breakdown might occur due to abnormal heating depending on the carrying condition. Therefore, please inquire when using with a circuit that causes an energized condition on both sides simultaneously.

REFERENCE DATA

1-(1). Coil temperature rise (at room temperature)

Sample: ACTP212, 3pcs.

Contact carrying current: 0A, 10A, 20A

Ambient temperature: Room temperature

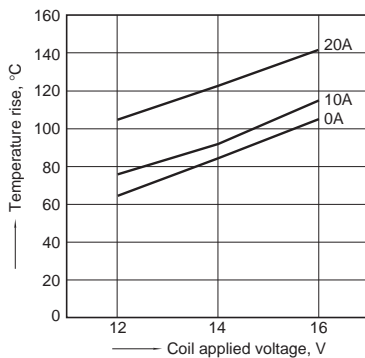

1-(2). Coil temperature rise (at 85°C 185°F)

Sample: ACTP212, 3pcs.

Contact carrying current: 0A, 10A, 20A

Ambient temperature: 85°C 185°F

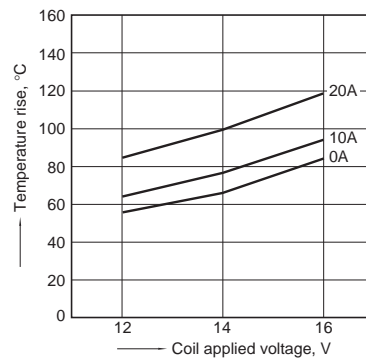

2. Ambient temperature and operating voltage range

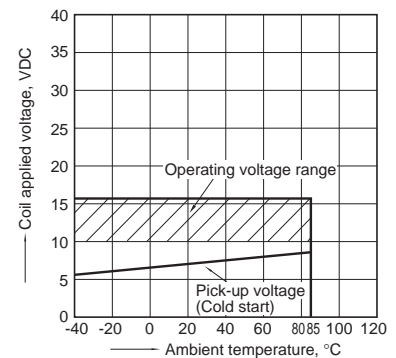

3. Distribution of pick-up and drop-out voltage

Sample: ACTP212, 80pcs.

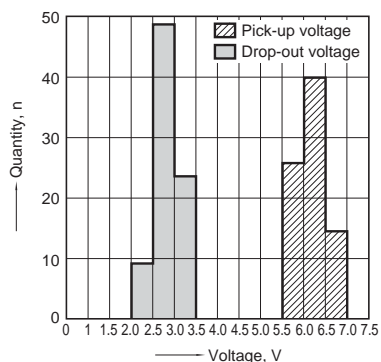

4. Distribution of operate and release time

Sample: ACTP212, 80pcs.

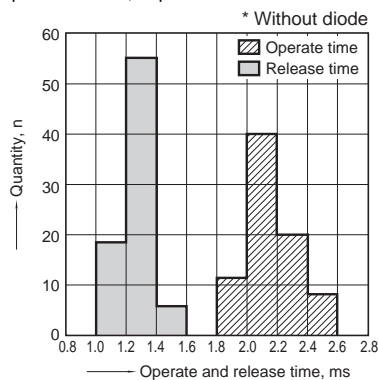

5. Electrical life test (Motor free)

Sample: ACTP212, 3pcs.
 Load: Inrush 30A, Steady 7A
 Brake current: 15A 14V DC,
 Power window motor actual load
 Operating frequency: ON 0.5s, OFF 9.5s
 Ambient temperature: Room temperature
 Circuit:

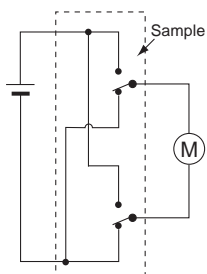

Change of pick-up and drop-out voltage

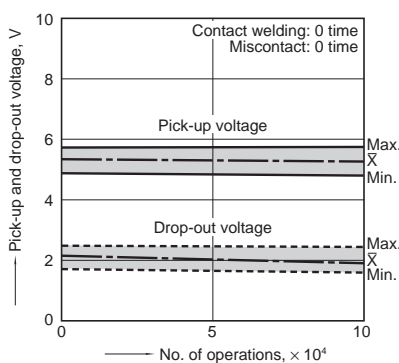

Change of contact resistance

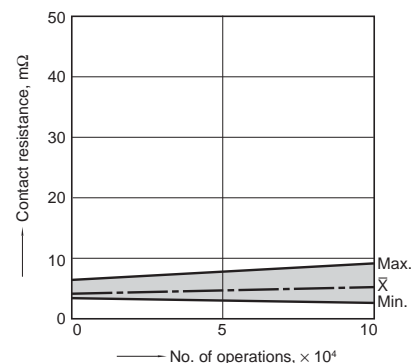

Load current waveform

Inrush current: 30A, Steady current: 7A
 Brake current: 15A

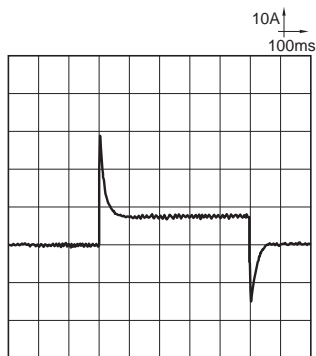

CT (ACTP)

6. Electrical life test (Motor lock)

Sample: ACTP212, 3pcs.
 Load: 30A 14V DC
 Operating frequency: ON 0.5s, OFF 9.5s
 Ambient temperature: Room temperature

Circuit:

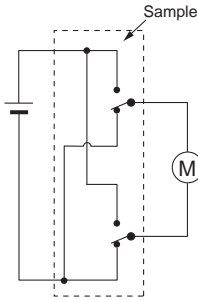

Change of pick-up and drop-out voltage

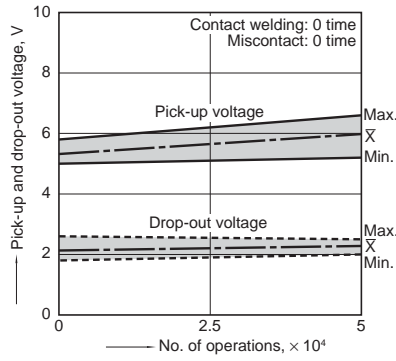

Change of contact resistance

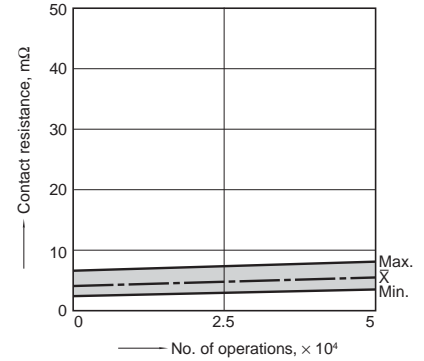

Load current waveform

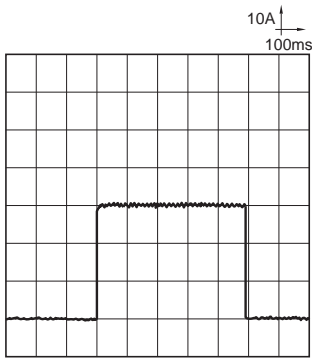

DIMENSIONS (mm inch)

1. Twin type (8 terminals)

[CAD Data](#)



External dimensions

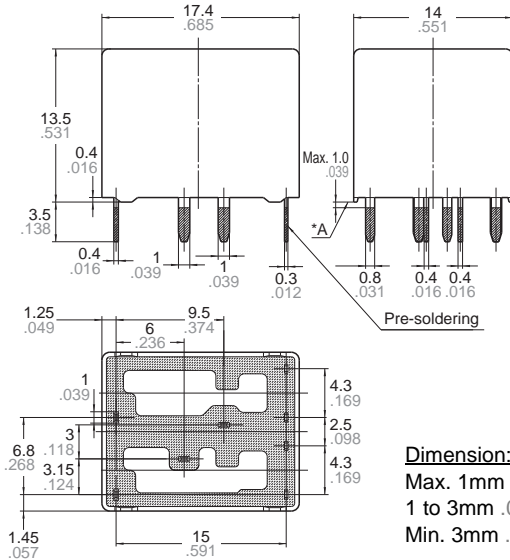

Dimension:
 Max. 1mm .039 inch:
 1 to 3mm .039 to .118 inch: $\pm 0.2 \pm 0.08$
 Min. 3mm .118 inch: $\pm 0.3 \pm 0.12$

Download [CAD Data](#) from our Web site.

PC board pattern (Bottom view)

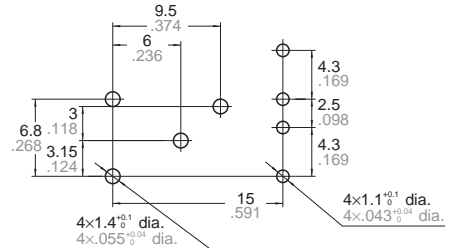

Tolerance: $\pm 0.1 \pm 0.04$

Schematic (Bottom view)

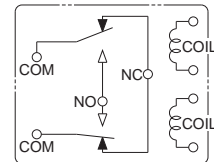

* Dimensions (thickness and width) of terminal is measured before pre-soldering.
 Intervals between terminals is measured at A surface level.

2. Twin type (10 terminals)

[CAD Data](#)



External dimensions

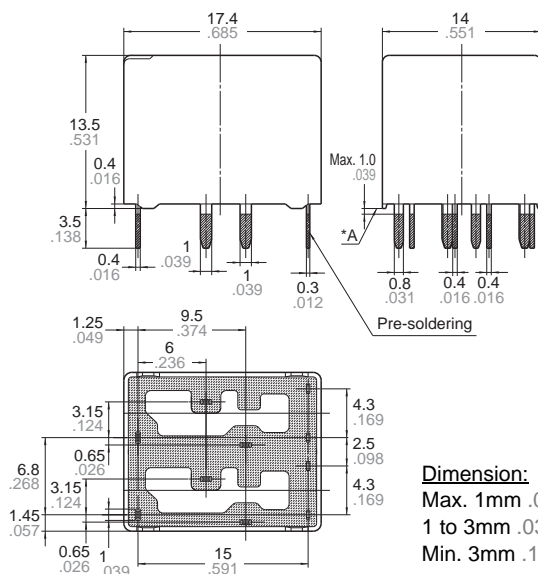

Dimension:	Tolerance
Max. 1mm .039 inch:	$\pm 0.1 \pm .004$
1 to 3mm .039 to .118 inch:	$\pm 0.2 \pm .008$
Min. 3mm .118 inch:	$\pm 0.3 \pm .012$

* Dimensions (thickness and width) of terminal is measured before pre-soldering.
Intervals between terminals is measured at A surface level.

PC board pattern (Bottom view)

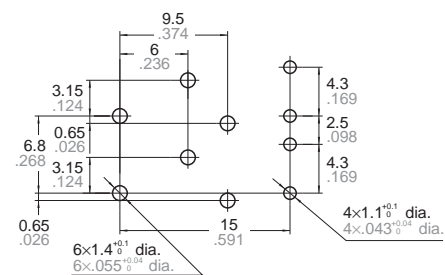

Tolerance: $\pm 0.1 \pm .004$

Schematic (Bottom view)

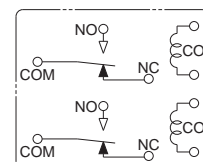

3. Single type (1 Form C)

[CAD Data](#)



External dimensions

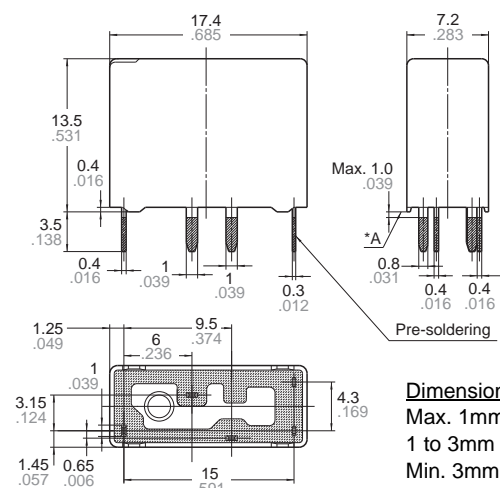

Dimension:	Tolerance
Max. 1mm .039 inch:	$\pm 0.1 \pm .004$
1 to 3mm .039 to .118 inch:	$\pm 0.2 \pm .008$
Min. 3mm .118 inch:	$\pm 0.3 \pm .012$

* Dimensions (thickness and width) of is measured before pre-soldering.
Intervals between terminals is measured at A surface level.

PC board pattern (Bottom view)

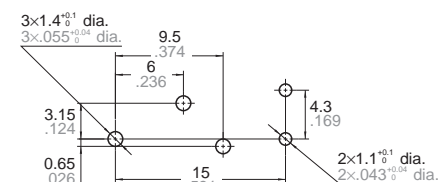

Tolerance: $\pm 0.1 \pm .004$

Schematic (Bottom view)

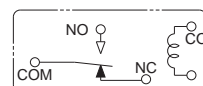

For Cautions for Use, see [Relay Technical Information](#).

Компания «Life Electronics» занимается поставками электронных компонентов импортного и отечественного производства от производителей и со складов крупных дистрибьюторов Европы, Америки и Азии.

С конца 2013 года компания активно расширяет линейку поставок компонентов по направлению коаксиальный кабель, кварцевые генераторы и конденсаторы (керамические, пленочные, электролитические), за счёт заключения дистрибьюторских договоров

Мы предлагаем:

- Конкурентоспособные цены и скидки постоянным клиентам.
- Специальные условия для постоянных клиентов.
- Подбор аналогов.
- Поставку компонентов в любых объемах, удовлетворяющих вашим потребностям.
- Приемлемые сроки поставки, возможна ускоренная поставка.
- Доставку товара в любую точку России и стран СНГ.
- Комплексную поставку.
- Работу по проектам и поставку образцов.
- Формирование склада под заказчика.
- Сертификаты соответствия на поставляемую продукцию (по желанию клиента).
- Тестирование поставляемой продукции.
- Поставку компонентов, требующих военную и космическую приемку.
- Входной контроль качества.
- Наличие сертификата ISO.

В составе нашей компании организован Конструкторский отдел, призванный помогать разработчикам, и инженерам.

Конструкторский отдел помогает осуществить:

- Регистрацию проекта у производителя компонентов.
- Техническую поддержку проекта.
- Защиту от снятия компонента с производства.
- Оценку стоимости проекта по компонентам.
- Изготовление тестовой платы монтаж и пусконаладочные работы.



Тел: +7 (812) 336 43 04 (многоканальный)

Email: org@lifeelectronics.ru