



FX29 COMPRESSION LOAD CELL

Versatile Miniature Force Sensor
mV, Amplified, and Digital Outputs
Low Power Consumption
Rugged Microfused Sensing Element
Stainless Steel Enclosure
Several Load Ranges

FEATURES

- Compact Design
- mV or Amplified Analog Outputs
- Optional I²C Digital Interface
- High Over Range Capability

APPLICATIONS

- Medical Infusion Pumps
- Analog & Digital Scales
- Fitness & Exercise Equipment
- Payload Weighing
- Power Tools
- Robotics
- Surgical & Dental Tools
- Battery Powered Devices
- Manufacturing Equipment

TE Connectivity's (TE) FX29 is a compact compression load cell that offers exceptional price-to-performance in a robust sensor package. Optimized for embedded force sensing applications from disposable medical devices to durable appliances and exercise equipment. The FX29 allows design flexibility with mV, amplified, and digital output options.

The FX29 incorporates the high reliability Microfused technology and is offered in ranges from 10lbf to 100lbf (50N to 500N). Microfused technology provides excellent span and zero stability, outstanding cycle life, superior resolution, high over-range capabilities, and an unamplified span sensitivity of 20mV/V.

The FX29 utilizes a two-piece construction of stainless steel materials. The combination of a metal injection molded flexure and micro miniaturized MEMS strain gauges allows flexibility of force range options for a lower cost sensor. These improvements over previous load cell designs give the FX29 more precise dimensional control and better performance.

Absolute Maximum Ratings (Analog)⁽¹⁾

Parameter	Symbol	Min	Typ	Max	Units	Notes/Conditions
Supply voltage	V _{dd}			6.0	V	Analog mV Output
				5.25	V	Analog 0.5-4.5V Output
Storage temperature	T _S	-40		+85	°C	
Compressive load	L _{max}			2.5X	Rated	
ESD		-4.0		4.0	kV	Human Body Model

⁽¹⁾ Maximum limits the device will withstand without damage

Standard Load Ranges

Pounds-Force (lbf)	Newtons (N)
10	50
25	125
50	250
100	500

Electrical Specifications (Analog)

(Unless otherwise specified, all parameters are measured at 25°C @ 5.0V applied)

Parameter	Symbol	Min	Typ	Max	Units	Notes/Conditions
Supply voltage (V _{supply})	V _{dd}	1.00		6.0	V	mV Output only
		4.75		5.25	V	0.5-4.5V Output only
Operating current	I _{dd}			3	mA	0.5-4.5V Output only
Input resistance	R _{in}	2.4	3.0	3.6	kΩ	mV Output only
Output resistance	R _{out}	1.76	2.2	2.64	kΩ	mV Output only
Rise time	T _r			2.0	ms	10% to 90%
Maximum output current	I _o	2.2			mA	0.5-4.5V Output only
Output short circuit duration	T _s			∞	seconds	0.5-4.5V Output only
Insulation resistance		50			MΩ	@250VDC
Bandwidth				1.0	kHz	

Operating Specifications (Analog)

(Unless otherwise specified, all parameters are measured at 25°C @ 5.0V applied)

Parameter	Symbol	Min	Typ	Max	Units	Notes/Conditions
Zero offset ¹		-15		15	mV/V	mV Output only
		300	500	700	mV	0.5-4.5V Output only
Full scale span ¹		16	20	24	mV/V	mV Output only
		3800	4000	4200	mV	0.5-4.5V Output only
Non-linearity		-1		1	%Span	BFSL
Hysteresis		-0.8		0.8	%Span	
Zero repeatability		-0.8		0.8	%Span	
Span repeatability		-0.8		0.8	%Span	
Thermal shift for zero		-0.05		0.05	%Span/°C	Reference to 25°C, over compensated temperature
Thermal shift for span		-0.05		0.05	%Span/°C	
Cycle life		1E+6				0 to full scale cycles
Deflection at rated load				0.03	mm	
Weight			6.0		grams	Without ribbon cable

⁽¹⁾Span and zero offset are ratiometric to power supply voltage

Environmental Specifications (Analog)

(Unless otherwise specified, all parameters are measured at 25°C @ 5.0V applied)

Parameter	Symbol	Min	Typ	Max	Units	Notes/Conditions
Compensated temperature range	T _o	0		50	°C	0.5-4.5V Output only
Storage temperature	T _s	-40		85	°C	
Ambient humidity		0		85	%RH	Non-condensing
EMI/RFI/ESD protection		IEC61000-4-2 (8kV _{air} /4kV _{contact}) IEC61000-4-3 (3V/m) IEC55032 Class A				mV Output only
Ingress protection	IP		43			
Media compatibility		External exposed surfaces: 17-4 and 304 stainless steel				Excluding cable & connector

Schematic Diagram – mV output (Analog)



Block Diagram – 0.5 to 4.5V output (Analog)



Absolute Maximum Ratings (Digital)⁽¹⁾

Parameter	Symbol	Min	Typ	Max	Units	Notes/Conditions
Supply voltage				5.50	V	
Storage temperature	T _S	-40		+85	°C	
Compressive load	L _{max}			2.5X	Rated	
ESD		-4.0		4.0	kV	Human Body Model

⁽¹⁾Maximum limits the device will withstand without damage

Standard Load Ranges

Pounds-Force (lbf)	Newtons (N)
10	50
25	125
50	250
100	500

Electrical Specifications (Digital)

(Unless otherwise specified, all parameters are measured at 25°C @ 3.0V applied)

Parameter	Symbol	Min	Typ	Max	Units	Notes/Conditions
Supply voltage (V _{supply})	V _{dd}	2.7		5.5	V	
Operating current	I _{dd}			3	mA	
Sleep mode current	I _{slp}		0.5	5	µA	
Insulation resistance		50			MΩ	@250VDC

Force Operating Specifications (Digital)

(Unless otherwise specified, all parameters are measured at 25°C @ 3.0V applied)

Parameter	Symbol	Min	Typ	Max	Units	Notes/Conditions
Zero offset		300	1000	1700	Counts	Base ₁₀
Full scale span		14300	15000	15700	Counts	Base ₁₀
Non-linearity		-1		1	%Span	BFSL
Hysteresis		-0.8		0.8	%Span	
Zero repeatability		-0.8		0.8	%Span	
Span repeatability		-0.8		0.8	%Span	
Thermal shift for zero		-0.05		0.05	%Span/°C	Reference to 25°C, over compensated temperature
Thermal shift for span		-0.05		0.05	%Span/°C	
Cycle life		1E+6				0 to full scale cycles
A/D resolution			14		Bits	
Response time				3	mS	4MHz, non-sleep mode
				8.4	mS	4MHz, sleep mode
Deflection at rated load				0.03	mm	
Weight			6.0		grams	Without ribbon cable

Environmental Specifications (Digital)

(Unless otherwise specified, all parameters are measured at 25°C @ 3.0V applied)

Parameter	Symbol	Min	Typ	Max	Units	Notes/Conditions
Compensated temperature range	T _o	0		50	°C	
Storage temperature	T _s	-40		85	°C	
Ambient humidity		0		85	%RH	Non-condensing
Ingress protection	IP	43				
Media compatibility		External exposed surfaces: 17-4 and 304 stainless steel				Excluding cable & connector

Block Diagram – I²C Digital Output (Digital)



Force Output Graph (Digital)



$$OUTPUT \text{ (decimal counts)} = \frac{14000}{LOAD \text{ RANGE}} * FORCE + 1000$$

Force Sensor Output		
%Output	Counts (decimal)	Counts (hex)
0%	1000	0x3E8
5%	1700	0x6A4
10%	2400	0x960
50%	8000	0x1F40
90%	13600	0x3250
95%	14300	0x37DC
100%	15000	0x3A98

I²C Typical Circuit

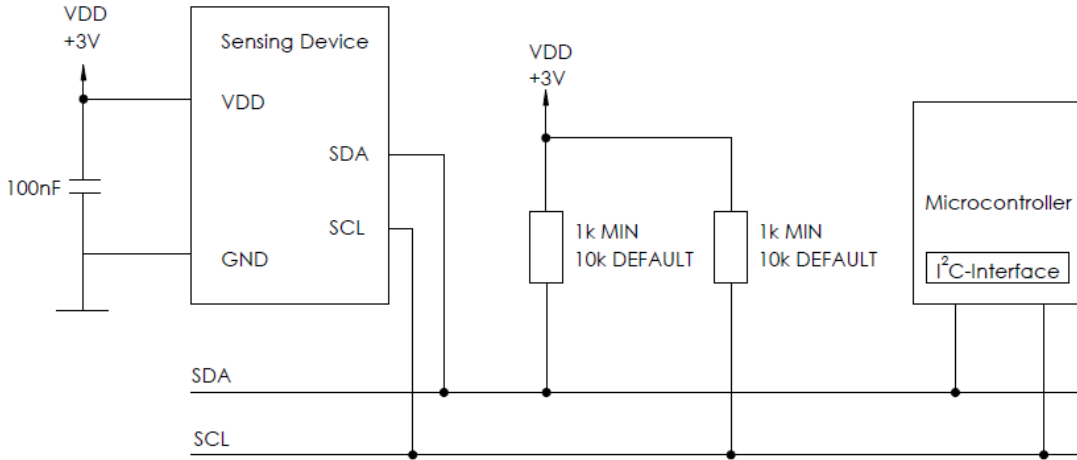

Note: only one pair of pull up resistors are needed for multiple sensing devices.

I²C Interface

Parameter	Symbol	Min	Typ	Max	Units	Notes/Conditions
SCLK clock frequency	F _{SCL}	100		400	kHz	
Start condition hold time relative to SCL edge	t _{HOSTA}	0.1			μS	
Minimum SCL clock low width ¹	t _{LOW}	0.6			μS	
Minimum SCL clock high width ¹	t _{HIGH}	0.6			μS	
Start condition startup time relative to SCL edge	t _{SUSTA}	0.1			μS	
Data hold time on SDA relative to SCL edge	t _{HDDAT}	0			μS	
Data setup time on SDA relative to SCL edge	t _{SUDAT}	0.1			μS	
Stop condition setup time on SCL	t _{SUSTO}	0.1			μS	
Bus free time between stop and start condition	t _{BUS}	2			μS	

I²C Interface Timing Diagram

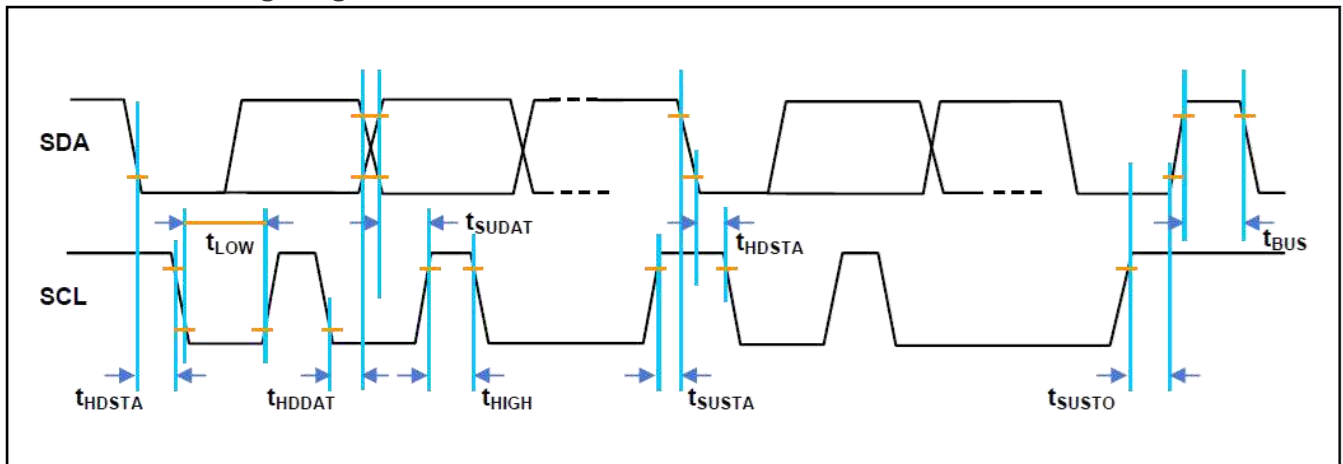

Digital Input and Output Parameters

(Unless otherwise specified, all parameters are measured at 25°C @ 3.0V applied)

Parameter	Symbol	Min	Typ	Max	Units	Notes/Conditions
Input high voltage	V _{IH}	0.8		1.0	x V _{DD}	
Input low voltage	V _{IL}	0.0V		0.2	x V _{DD}	
Output low level					x V _{DD}	
Load capacitance @ SDA				200	pF	@400 kHz
Input capacitance (each pin)				10	pF	

I²C Measurement Packet Read Sequence

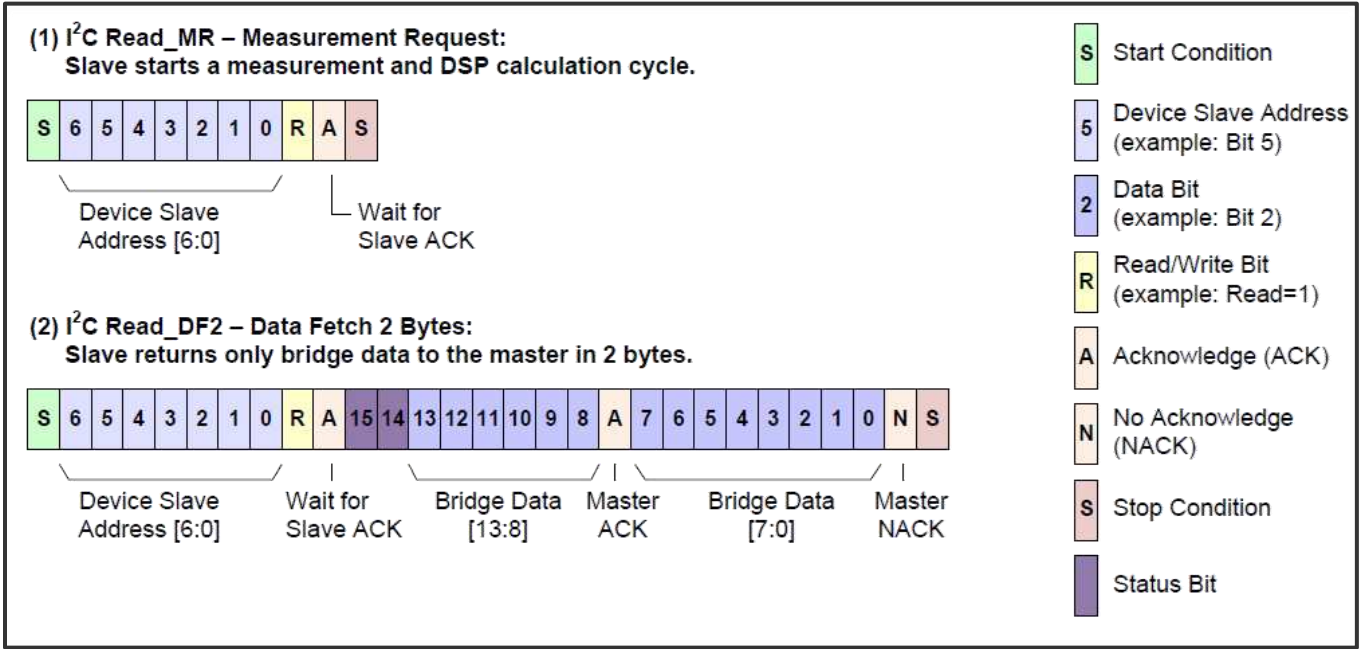

General Working Mode

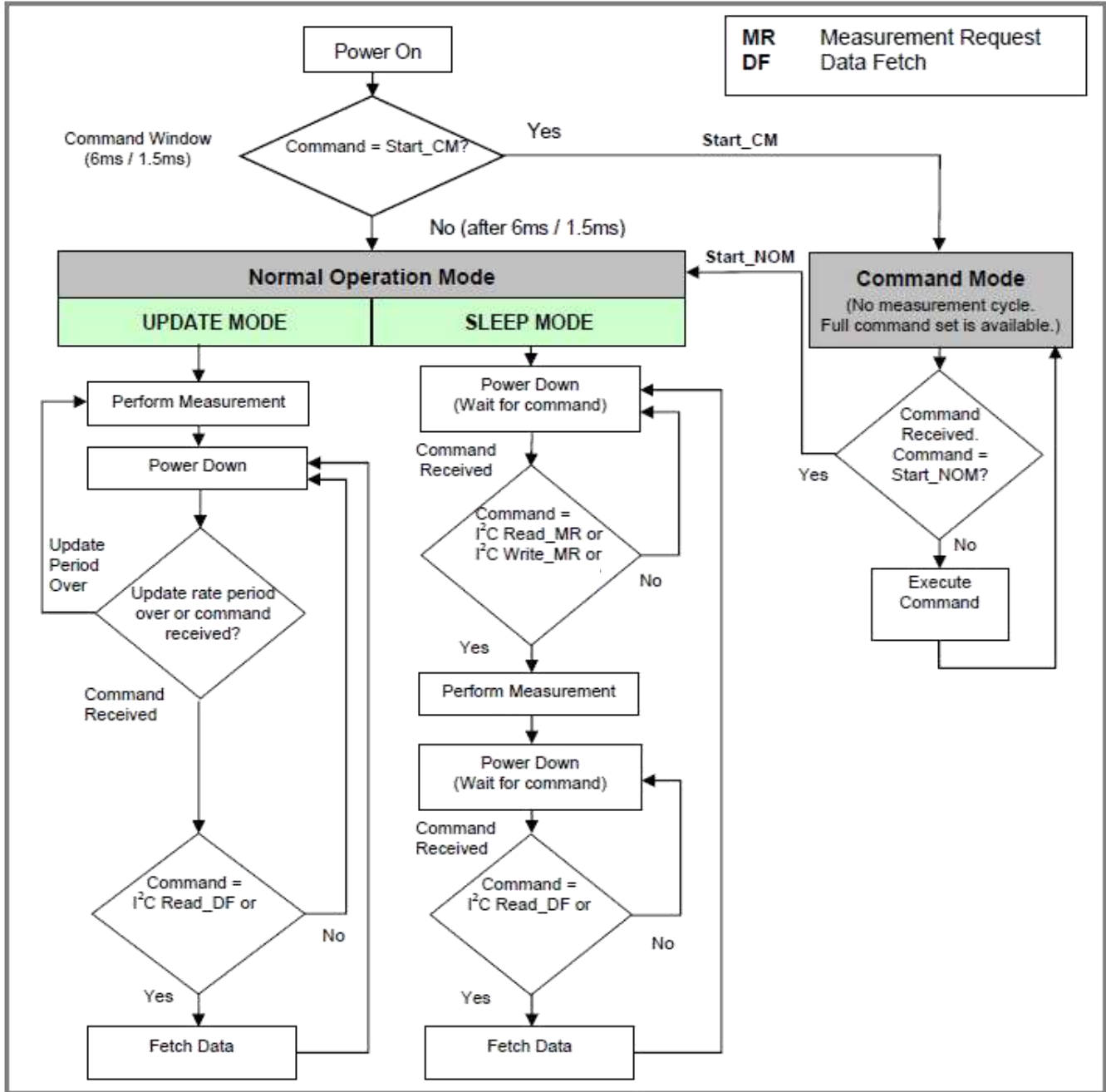

Outline Drawing and Connections



CONNECTIONS INFORMATION:

PIN	WIRE COLOR	OUTPUT SIGNAL		
		mV	0.5~4.5V	I ² C
1	RED	V+	V+	V+
2	YELLOW	O+	O+	SCL
3	WHITE	O-	N/A	SDA
4	BLACK	V-	COMMON	V-

CONNECTOR INFORMATION:

BRAND	PART	DESCRIPTION	MATING RECOMMENDATION
TE	HOUSING	TE: # 440146-4, CONN RCPT 4POS SGL 1.25MM NATRL	TE# 1734598-4, CONN HEADER VERT 4POS 1.25MM
	TERMINAL	TE: # 1734193-1, CONN SOCKET 28-32AWG CRIMP TIN	

mV OUTPUT

WIRING INFORMATION

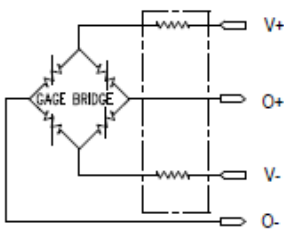

0.5~4.5V OUTPUT

WIRING INFORMATION

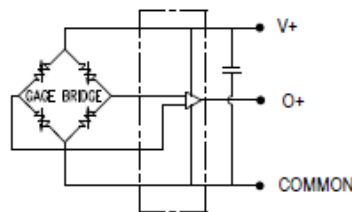

I²C OUTPUT

WIRING INFORMATION

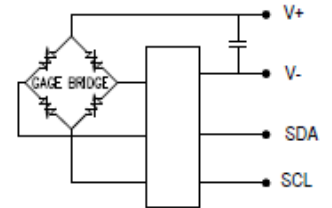

Ordering Information

FX29 **x x** - **xxx x** - **xxxx** - **x**

Output Signal		
Code	Output	Output Type
2	20 mV/V*	mV
3	0.5 – 4.5V*	Amplified
J	I²C (No sleep)*	Digital
K	I²C (Sleep)	Digital

I ² C Address	
Code	Device Address (hex)
X	Analog Output*
0	0x28*
1	0x36
2	0x46
3	0x48
4	0x51

Cable Length	
Code	Length
040	40 mm
100	100 mm*
XXX	Custom Length

Measurement Units	
L	Pounds-force (lbf)*
N	Newton

Load Range	
LBF	Newton
0010*	0050
0025*	0125
0050*	0250
0100*	0500

Cable & Connector	
Code	Cable and Connector
A	4-wire ribbon cable without connector*
B	4-wire ribbon cable with connector

Note:
For digital output, ensure custom cable length does not exceed 1 meter.

*Sensor features shown in **bold** are typically stocked by our distribution partners, or available with short lead times from the factory depending on availability. Contact customer service for details.

REVISION HISTORY			
Revision Number	Change Description	Date	Approval
A0	Initial release	05/13/2019	PRS
A3	Minor corrections ;	06/24/2019	MH

NORTH AMERICA
Tel +1 800 522 6752
customercare.frm1@te.com

EUROPE
Tel +31 73 624 6999
customercare.lcsb@te.com

ASIA
Tel +86 0400 820 6015
customercare.shzn@te.com

te.com/sensorsolutions

Microfused, TE Connectivity, TE Connectivity (logo) and EVERY CONNECTION COUNTS are trademarks. All other logos, products and/or company names referred to herein might be trademarks of their respective owners.

The information given herein, including drawings, illustrations and schematics which are intended for illustration purposes only, is believed to be reliable. However, TE Connectivity makes no warranties as to its accuracy or completeness and disclaims any liability in connection with its use. TE Connectivity's obligations shall only be as set forth in TE Connectivity's Standard Terms and Conditions of Sale for this product and in no case will TE Connectivity be liable for any incidental, indirect or consequential damages arising out of the sale, resale, use or misuse of the product. Users of TE Connectivity products should make their own evaluation to determine the suitability of each such product for the specific application.

© 2019 TE Connectivity Ltd. family of companies All Rights Reserved.



Компания «Life Electronics» занимается поставками электронных компонентов импортного и отечественного производства от производителей и со складов крупных дистрибьюторов Европы, Америки и Азии.

С конца 2013 года компания активно расширяет линейку поставок компонентов по направлению коаксиальный кабель, кварцевые генераторы и конденсаторы (керамические, пленочные, электролитические), за счёт заключения дистрибьюторских договоров

Мы предлагаем:

- Конкуренспособные цены и скидки постоянным клиентам.
- Специальные условия для постоянных клиентов.
- Подбор аналогов.
- Поставку компонентов в любых объемах, удовлетворяющих вашим потребностям.
- Приемлемые сроки поставки, возможна ускоренная поставка.
- Доставку товара в любую точку России и стран СНГ.
- Комплексную поставку.
- Работу по проектам и поставку образцов.
- Формирование склада под заказчика.
- Сертификаты соответствия на поставляемую продукцию (по желанию клиента).
- Тестирование поставляемой продукции.
- Поставку компонентов, требующих военную и космическую приемку.
- Входной контроль качества.
- Наличие сертификата ISO.

В составе нашей компании организован Конструкторский отдел, призванный помогать разработчикам, и инженерам.

Конструкторский отдел помогает осуществить:

- Регистрацию проекта у производителя компонентов.
- Техническую поддержку проекта.
- Защиту от снятия компонента с производства.
- Оценку стоимости проекта по компонентам.
- Изготовление тестовой платы монтаж и пусконаладочные работы.



Тел: +7 (812) 336 43 04 (многоканальный)

Email: org@lifeelectronics.ru