

The S-8540/8541 Series is a family of CMOS step-down switching regulator controllers with PWM control (S-8540 Series) and PWM/PFM switchover control (S-8541 Series). These devices consist of a reference voltage source, oscillation circuit, an error amplifier, phase compensation circuit, PWM control circuit, current limit circuit. A high efficiency and large current switching regulator is realized with the help of small external components due to the high oscillation frequency, 300 kHz and 600 kHz.

The S-8540 Series provides low-ripple voltage, high efficiency, and excellent transient characteristics which come from the PWM control circuit capable of varying the duty ratio linearly from 0 to 100%, the optimized error amplifier, and the phase compensation circuit.

The S-8541 Series operates under PWM control when the duty ratio is 29% or higher and operates under PFM control when the duty ratio is less than 29% to ensure high efficiency over all load range.

These controllers serve as ideal main power supply units for portable devices due to the high oscillation frequencies together with the small 8-Pin MSOP package.

■ Features

- Oscillation frequency
600 kHz (A, B types)
300 kHz (C, D types)
- Output voltage
1.5 to 6.0 V, selectable in 0.1V steps (A, C types)
- Output voltage precision
±2.0%
- Feed back type for output voltage (FB)
- External components:
a transistor, a coil, a diode, and capacitors
- Built-in PWM/PFM switchover control
Duty ratio: 29% (PFM control)
29 to 100% (PWM control)
- Current limit circuit
Current is set by an external resistor R_{SENSE} .
- Soft-start
Time is set by a capacitor C_{SS} and a resistor R_{SS} .
- Shutdown function
- Lead-free, halogen-free*1

*1. Refer to “■ Product Name Structure” for details.

■ Applications

- Power supplies for PDAs, electric organizers, and portable devices.
- Power supplies for audio equipment such as portable CD players and headphone stereos.
- Main or sub Power supplies for notebook computers and peripheral equipment.

■ Package

- 8-Pin MSOP

■ Block Diagrams

1. A, C types (fixed output voltage)

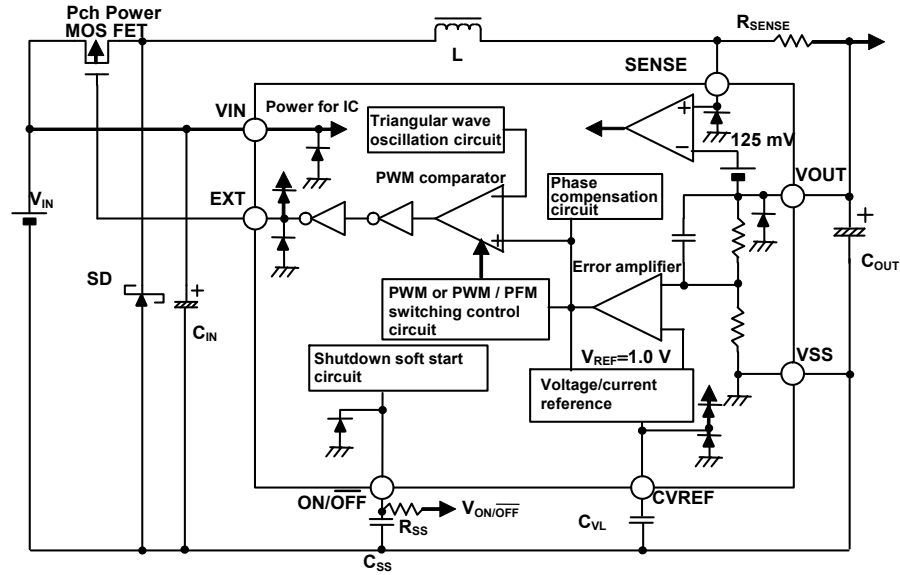

Figure 1

2. B, D types (feed back)

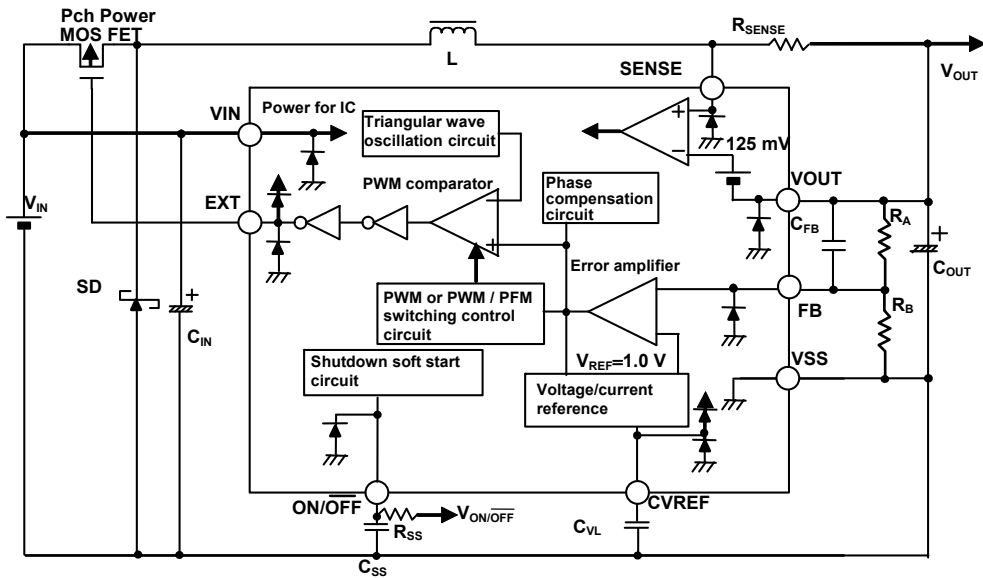
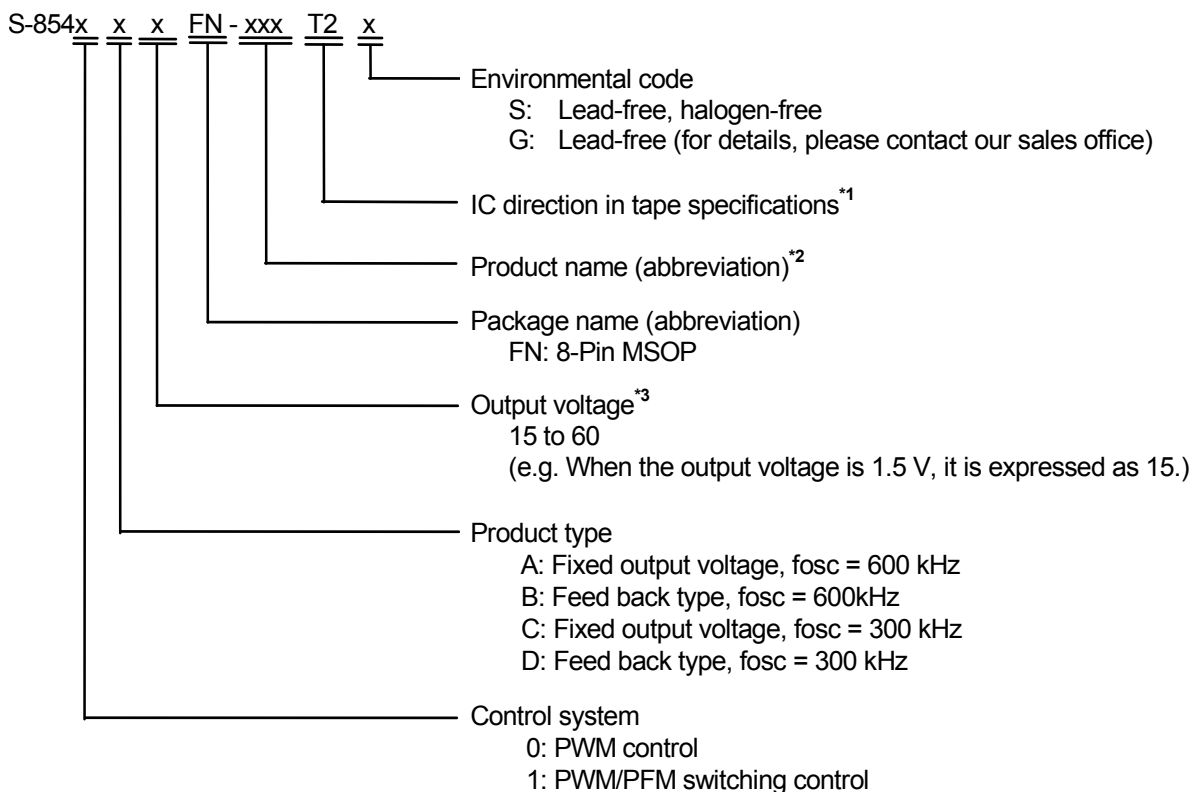

Figure 2

■ Product Name Structure

The control types, product types, and output voltage for the S-8540/8541 series can be selected at the user's request. Please refer to the "1. Product name" for the definition of the product name, "2. Package" regarding the package drawings and "3. Product name list" for the full product names.

1. Product name



*1. Refer to the taping specifications at the end of this book.

*2. Refer to the "3. Product name list".

*3. 00: Feed back type

2. Package

Package Name	Drawing Code		
	Package	Tape	Reel
8-Pin MSOP	FN008-A-P-SD	FN008-A-C-SD	FN008-A-R-SD

3. Product name list

3.1 A, B types (oscillation frequency: 600 kHz)

Table 1

Output Voltage (V)	S-8540xxxFN Series	S-8541xxxFN Series
1.5	S-8540A15FN-IAAT2z	–
1.6	–	S-8541A16FN-IGBT2z
1.8	S-8540A18FN-IADT2z	S-8541A18FN-IGDT2z
2.5	S-8540A25FN-IAKT2z	S-8541A25FN-IGKT2z
3.3	S-8540A33FN-IAST2z	S-8541A33FN-IGST2z
5.0	S-8540A50FN-IBBT2z	–
Feed back (1.5 to 6.0)	S-8540B00FN-IMAT2z	S-8541B00FN-IMDT2z

3.2 C,D types (oscillation frequency: 300 kHz)

Table 2

Output Voltage (V)	S-8540xxxFN Series	S-8541xxxFN Series
1.8	S-8540C18FN-ICDT2z	S-8541C18FN-IIDT2z
2.5	S-8540C25FN-ICKT2z	S-8541C25FN-IIKT2z
3.2	–	S-8541C32FN-IIRT2z
3.3	S-8540C33FN-ICST2z	S-8541C33FN-IIST2z
Feed back (1.5 to 6.0)	S-8540D00FN-IMBT2z	S-8541D00FN-IMET2z

Remark 1. Please consult the ABLIC Inc. marketing department for products with an output voltage other than those specified above.

2. z: G or S
3. Please select products of environmental code = U for Sn 100%, halogen-free products.

■ Pin Configuration

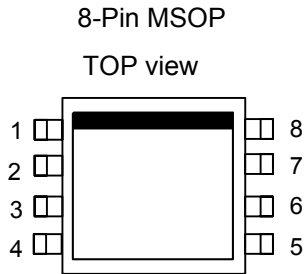

Figure 3

Table 3

Pin No.	Pin Name	Pin Description
1	VSS	GND pin
2	EXT	Connection pin for external transistor
3	VIN	IC power supply pin
4	CVREF	Bypass capacitor connection pin for reference voltage source
5	ON/OFF	Shutdown pin Soft-start capacitor connection pin <ul style="list-style-type: none"> • Normal operation (step-down operation) • All circuit halts (no step-down operation)
6	NC ^{*1}	None connected (A, C types)
	FB	Feed back pin (B, D types)
7	VOUT	Output voltage pin
8	SENSE	Current limit detection pin

*1. The NC pin is electrically open.
 The NC pin can be connected to VIN and VSS.

■ **Absolute Maximum Ratings**

Table 4

(Ta = 25 °C unless otherwise specified)

Item	Symbol	Absolute Maximum Ratings	Unit
VIN pin voltage	V _{IN}	V _{SS} - 0.3 to V _{SS} + 12	V
CVREF pin voltage	V _{CVREF}	V _{SS} - 0.3 to V _{IN} + 0.3	V
ON/OFF pin voltage	V _{ON/OFF}	V _{SS} - 0.3 to V _{SS} + 12	V
FB pin voltage*1	V _{FB}	V _{SS} - 0.3 to V _{SS} + 12	V
VOUT pin voltage	V _{OUT}	V _{SS} - 0.3 to V _{SS} + 12	V
SENSE pin voltage	V _{SENSE}	V _{SS} - 0.3 to V _{SS} + 12	V
EXT pin voltage	V _{EXT}	V _{SS} - 0.3 to V _{IN} + 0.3	V
EXT pin current	I _{EXT}	± 100	mA
Power dissipation	P _D	300 (When not mounted on board)	mW
		500*2	mW
Operating ambient temperature	T _{opr}	- 40 to + 85	°C
Storage temperature	T _{stg}	- 40 to + 125	°C

*1. Feed back type (B, D types)

*2. When mounted on board

[Mounted board]

(1) Board size : 114.3 mm × 76.2 mm × t1.6 mm

(2) Board name : JEDEC STANDARD51-7

Caution The absolute maximum ratings are rated values exceeding which the product could suffer physical damage. These values must therefore not be exceeded under any conditions.

(1) When mounted on board

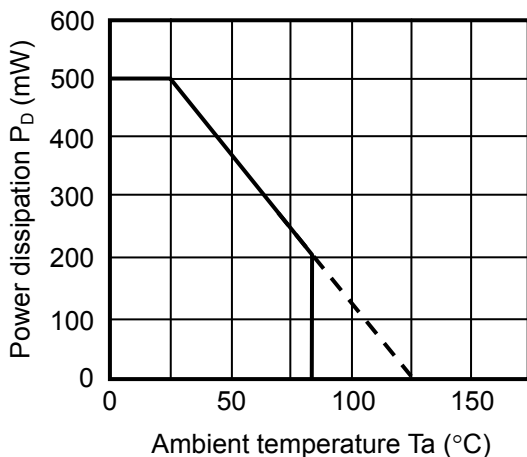

(2) When not mounted on board

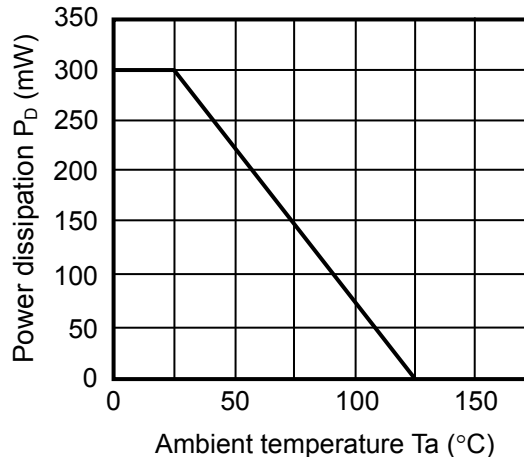

Figure 4 Power Dissipation of Package

■ Electrical Characteristics

1. S-8540/8541 Series A, C types

Table 5

(Ta = 25 °C, unless otherwise specified)

Parameter	Symbol	Conditions	Min.	Typ.	Max.	Units	Measurement Circuit	
Output voltage *1	$V_{OUT(E)}$	$V_{IN} = V_{OUT(S)} \times 1.5$ $I_{OUT} = 120 \text{ mA}$	$V_{OUT(S)} \times 0.980$	$V_{OUT(S)}$	$V_{OUT(S)} \times 1.020$	V	2	
Input voltage	V_{IN}	-	2.5	-	10.0	V	1	
Current consumption 1	I_{SS1}	$V_{IN} = V_{OUT(S)} \times 1.5$ 100 % duty ratio	S-8540/8541Axx	-	180	300	μA	1
			S-8540/8541Cxx	-	140	240		
Current consumption during shutdown	I_{SSS}	$V_{ON/OFF} = 0 \text{ V}$ $V_{OUT} = V_{OUT(S)} \times 0.95$	-	-	1.0	μA	1	
EXT pin output current	I_{EXTH}	$V_{IN} = 10 \text{ V}, V_{EXT} = V_{IN} - 0.2 \text{ V}$	-32	-48	-	mA	1	
	I_{EXTL}	$V_{IN} = 10 \text{ V}, V_{EXT} = 0.2 \text{ V}$	45	66	-	mA	1	
Line regulation	ΔV_{OUT1}	$V_{OUT(S)} \times 1.1 \leq V_{IN} \leq 10 \text{ V}, I_{OUT} = 120 \text{ mA}$	-	30	60	mV	2	
Load regulation	ΔV_{OUT2}	$V_{IN} = V_{OUT(S)} \times 1.5, 10 \mu\text{A} \leq I_{OUT} \leq 150 \text{ mA}$	-	30	60	mV	2	
Output voltage temperature coefficient	$\frac{\Delta V_{OUT}}{\Delta T_a \cdot V_{OUT}}$	$V_{IN} = V_{OUT(S)} \times 1.5, I_{OUT} = 120 \text{ mA}$ $-40 \leq T_a \leq +85 \text{ }^\circ\text{C}$	-	± 100	-	ppm/ $^\circ\text{C}$	2	
Oscillation frequency	f_{OSC}	Measure waveform at the EXT pin.	S-8540/8541Axx	510	600	690	kHz	2
			S-8540/8541Cxx	255	300	345		
Maximum duty ratio	MaxDuty	Measure waveform at the EXT pin.	100	-	-	%	2	
PWM/PFM-control switch duty ratio *2	PFMDuty	$V_{IN} = V_{OUT(S)} \times 1.5$, no load	19	29	39	%	2	
Current limit detection voltage	V_{SENSE}	$V_{IN} = V_{OUT(S)} \times 1.5$, Measure waveform at the EXT pin.	100	125	150	mV	1	
SENSE pin input current	I_{SENSE}	$V_{IN} = V_{OUT(S)} \times 1.5, V_{SENSE} = V_{IN} - 0.1 \text{ V}$	6.7	11.2	16.8	μA	1	
Shutdown pin input voltage	V_{SH}	$V_{IN} = V_{OUT(S)} \times 1.5$, Judge $V_{OUT(S)} \times 0.98$.	2.3	-	-	V	2	
	V_{SL}	$V_{IN} = V_{OUT(S)} \times 1.5$, Judge CVREF pin "L".	-	-	0.3	V	1	
Shutdown pin input leakage current	I_{SH}	$V_{IN} = V_{OUT(S)} \times 1.5, V_{ON/OFF} = V_{OUT}$	-0.1	-	0.1	μA	1	
	I_{SL}	$V_{IN} = V_{OUT(S)} \times 1.5, V_{ON/OFF} = 0 \text{ V}$	-0.1	-	0.1	μA	1	
Soft-start time	t_{SS}	Time until $V_{OUT(E)}$ reaches 90% or higher of the $V_{OUT(S)}$	7.0	12.0	17.0	ms	2	
Efficiency	EFFI	-	-	90	-	%	2	

External components

Coil (L)	:Sumida Corporation. CDRH6D28-100
Diode (SD)	:Matsushita Electric Industrial Co., Ltd. MA2Q737 (Schottky diode)
Output capacitor (C_{OUT})	:Nichicon Corporation F93 (16 V, 47 μF , tantalum)
Input capacitor (C_{IN})	:Nichicon Corporation F93 (16 V, 47 μF , tantalum)
Transistor (P_{SW})	:Toshiba Corporation 2SA1213
Base resistor (R_b)	:100 m Ω
Base capacitor (C_b)	:2200 pF
C_{VL}	:1.0 μF
C_{SS}	:0.047 μF
R_{SS}	:220 k Ω
R_{SENSE}	:100 m Ω

Condition: Recommended parts are used unless otherwise specified.

$$V_{IN} = V_{OUT(S)} \times 1.5 \text{ V}, I_{OUT} = 120 \text{ mA} \quad (\text{When } V_{OUT(S)} \leq 1.6 \text{ V, then } V_{IN} = 2.5 \text{ V})$$

*1. $V_{OUT(S)}$: Specified output voltage value, $V_{OUT(E)}$: Actual output voltage value

*2. Applied to the S-8541 series only

Caution 1. Line regulation and load regulation may change greatly due to GND wiring when V_{IN} is high.
2. In the S-8540 series (PWM control), a state in which the duty ratio 0% continues for several clocks may occur when the input voltage is high and the output current is low. In this case, the operation changes to the pseudo PFM mode, but the ripple voltage hardly increases.

2. S-8540/8541 Series B, D types

Table 6

(Ta = 25 °C, unless otherwise specified)

Parameter	Symbol	Conditions	Min.	Typ.	Max.	Units	Measurement Circuit	
Output voltage *1, *2	$V_{OUT(E)}$	$V_{IN} = 4.5\text{ V}$ $I_{OUT} = 120\text{ mA}$	$V_{OUT(S)} \times 0.980$	$V_{OUT(S)} = 3.000$	$V_{OUT(S)} \times 1.020$	V	4	
Input voltage	V_{IN}	–	2.5	–	10.0	V	3	
Current consumption 1	I_{SS1}	$V_{IN} = 4.5\text{ V}$ 100% duty ratio	S-8540/8541B00	–	180	300	μA	3
			S-8540/8541D00	–	140	240		
Current consumption during shutdown	I_{SSS}	$V_{ON/OFF} = 0\text{ V}$ $V_{OUT} = V_{OUT(S)} \times 0.95$	–	–	1.0	μA	3	
EXT pin output current	I_{EXTH}	$V_{IN} = 10\text{ V}, V_{EXT} = V_{IN} - 0.2\text{ V}$	–32	–48	–	mA	3	
	I_{EXTL}	$V_{IN} = 10\text{ V}, V_{EXT} = 0.2\text{ V}$	45	66	–	mA	3	
Line regulation	ΔV_{OUT1}	$3.3 \leq V_{IN} \leq 10\text{ V}, I_{OUT} = 120\text{ mA}$	–	30	60	mV	4	
Load regulation	ΔV_{OUT2}	$10\ \mu\text{A} \leq I_{OUT} \leq 150\text{ mA}$	–	30	60	mV	4	
Output voltage temperature coefficient	$\frac{\Delta V_{OUT}}{\Delta T_a \cdot V_{OUT}}$	$V_{IN} = V_{OUT(S)} \times 1.5, I_{OUT} = 120\text{ mA}$ $-40 \leq T_a \leq +85^\circ\text{C}$	–	± 100	–	ppm/ °C	4	
Oscillation frequency	f_{OSC}	Measure waveform at the EXT pin.	S-8540/8541B00	510	600	690	kHz	4
			S-8540/8541D00	255	300	345		
Maximum duty ratio	MaxDuty	Measure waveform at the EXT pin.	100	–	–	%	4	
PWM/PFM-control switch duty ratio *3	PFM Duty	$V_{IN} = V_{OUT(S)} \times 1.5\text{ V}$, no load	19	29	39	%	4	
Current limit detection voltage	V_{SENSE}	$V_{IN} = 4.5\text{ V}$, Measure waveform at the EXT pin.	100	125	150	mV	3	
SENSE pin input current	I_{SENSE}	$V_{IN} = 4.5\text{ V}, V_{SENSE} = V_{IN} - 0.1\text{ V}$	6.7	11.2	16.8	μA	3	
Shutdown pin input voltage	V_{SH}	$V_{IN} = 4.5\text{ V}$, Judge $V_{OUT(S)} \times 0.98$.	2.3	–	–	V	4	
	V_{SL}	$V_{IN} = 4.5\text{ V}$, Judge CVREF pin "L".	–	–	0.3	V	3	
Shutdown pin input leakage current	I_{SH}	$V_{IN} = 4.5\text{ V}, V_{ON/OFF} = V_{OUT}$	–0.1	–	0.1	μA	3	
	I_{SL}	$V_{IN} = 4.5\text{ V}, V_{ON/OFF} = 0\text{ V}$	–0.1	–	0.1	μA	3	
Soft-start time	t_{SS}	Time until $V_{OUT(E)}$ reaches 90% or higher of the $V_{OUT(S)}$	7.0	12.0	17.0	ms	4	
Efficiency	EFFI	–	–	90	–	%	4	

External components:

Coil (L)	:Sumida Corporation CDRH6D28-100
Diode (SD)	:Matsushita Electric Industrial Co., Ltd. MA2Q737 (Schottky diode)
Output capacitor (C_{OUT})	:Nichicon Corporation F93 (16 V, 47 μF , tantalum)
Input capacitor (C_{IN})	:Nichicon Corporation F93 (16 V, 47 μF , tantalum)
Transistor (P_{SW})	:Toshiba Corporation 2SA1213
Base resistor (R_b)	:100 m Ω
Base capacitor (C_b)	:2200 pF
C_{VL}	:1.0 μF
C_{SS}	:0.047 μF
R_{SS}	:220 k Ω
R_{SENSE}	:100 m Ω
R_A	:200 k Ω
R_B	:100 k Ω
C_{FB}	:50 pF

Condition: Connect recommended parts unless otherwise specified. $V_{IN} = 4.5\text{ V}$, $I_{OUT} = 120\text{ mA}$

*1. $V_{OUT(S)}$: Specified output voltage value, $V_{OUT(E)}$: Actual output voltage value

*2. The typical value (specified output voltage value) is $V_{OUT(S)} = 1 + R_A/R_B = 3.0\text{ V}$. See "Output Voltage adjustment".

*3. S-8541 series only

Caution 1. Line regulation and load regulation may change greatly due to GND wiring when V_{IN} is high.
 2. In the S-8540 series (PWM control), a state in which the duty ratio 0% continues for several clocks may occur when the input voltage is high and the output current is low. In this case, the operation changes to the pseudo PFM mode, but the ripple voltage hardly increases.

■ Measurement Circuits

1.

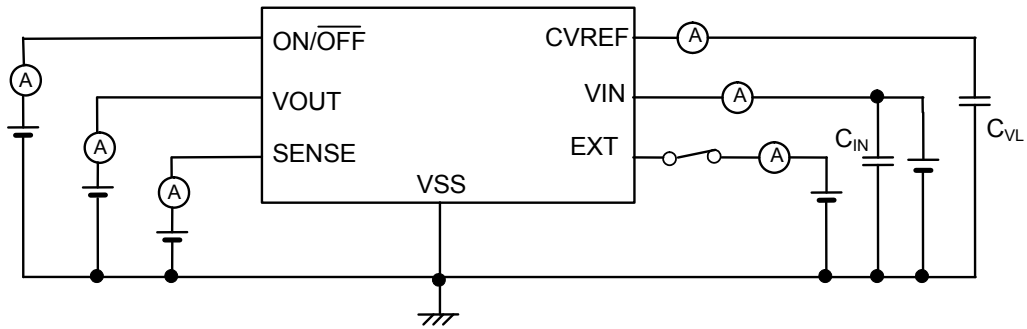

Figure 5

2.

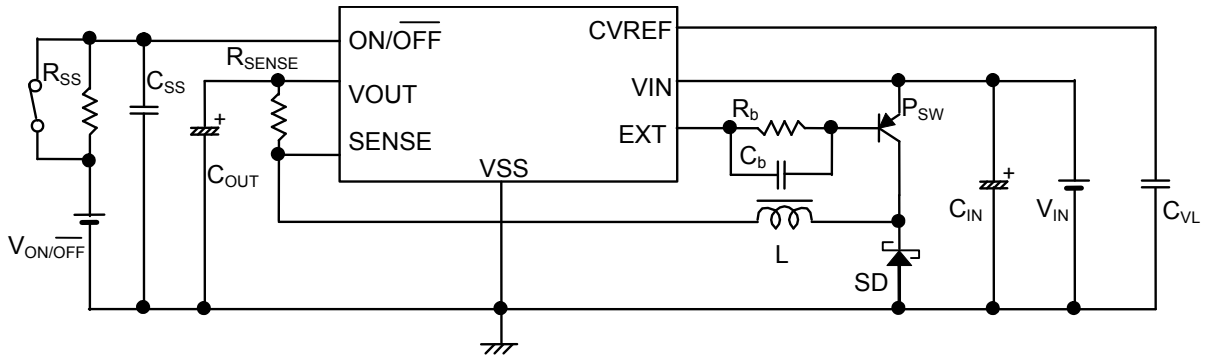

Figure 6

3.

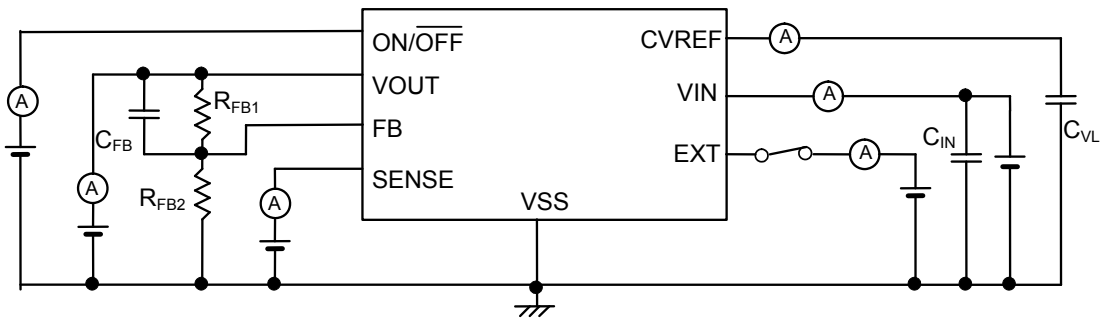

Figure 7

4.

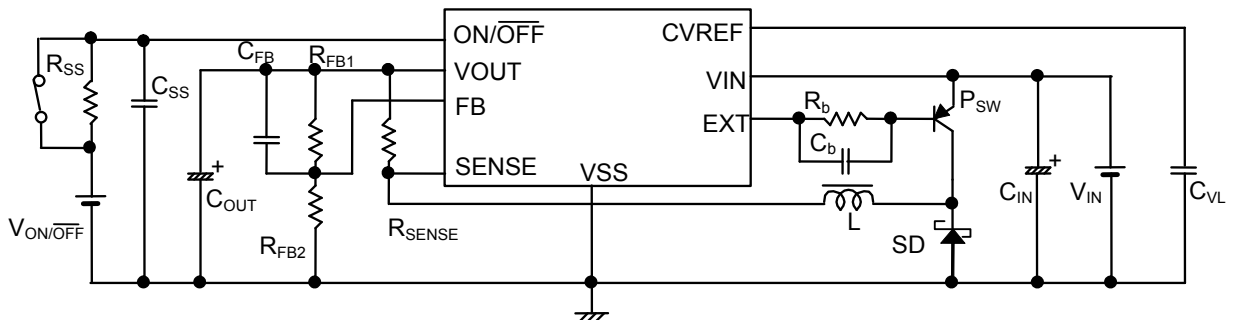

Figure 8

■ Operation

1. Switching control method

1.1 PWM control (S-8540 Series)

The S-8540 series consists of pulse width modulation (PWM) DC/DC converters. In conventional pulse frequency modulation (PFM) DC/DC converters, pulses are skipped when they operate at low output load current, causing the variation in the ripple frequency and the increase in the ripple voltage of the output voltage both of which constitute inherent drawbacks to those converters.

In the S-8540 series the pulse width varies in the range from 0 to 100% according to the load current, yet ripple voltage produced by the switching can easily be removed by a filter since the switching frequency is always constant. These converters thus provide a low-ripple voltage over wide range of input voltage and load current. And it will be skipped to be low current consumption when the pulse width is 0% or it is no load, input current voltage is high.

1.2 PWM/PFM switchover control (S-8541 Series)

The S-8541 series is a DC-DC converter that automatically switches between a pulse width modulation method (PWM) and a pulse frequency modulation method (PFM), depending on the load current, and features low current consumption.

The S-8541 series operates under PWM control with the pulse width duty changing from 29 to 100% when the output load current is high. On the other hand, when the output current is low, the S-8541 series operates under PFM control with the pulse width duty fixed at 29%, and pulses are skipped according to the load current. The oscillation circuit thus oscillates intermittently so that the resultant lower self current consumption prevents a reduction in the efficiency when the load current is low. The switching point from PWM control to PFM control depends on the external devices (coil, diode, etc.), input voltage, and output voltage. This series is an especially efficient DC-DC converter at an output current of around 100 μ A.

2. Soft-start function

The S-8540/8541 series has a built-in soft-start circuit. This circuit enables the output voltage to rise gradually over the specified soft-start time to suppress the overshooting of the output voltage and the rush current from the power source when the power is switched on or the power-off pin is set to "H"

The soft-start function of this IC, however, can not suppress rush current to the load completely (Refer to **Figure 9**). The rush current is affected by the input voltage and the load. Please evaluate the rush current under the actual test condition.

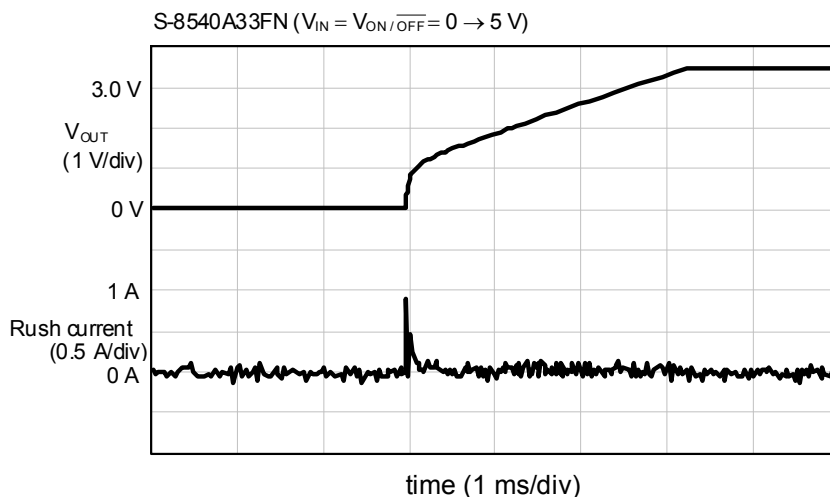

Figure 9 Waveforms of output voltage and rush current at soft-start

The soft-start function of the IC is achieved by raising internal reference voltage gradually, which is caused by the raising of shutdown pin voltage through RC components (R_{SS} and C_{SS}) connected to shutdown pin.

A soft-start time (t_{SS}) is changed by R_{SS} , C_{SS} and the input voltage $V_{ON/OFF}$ to R_{SS} . t_{SS} is calculated from the following formula:

$$t_{SS} [\text{ms}] = R [\text{k}\Omega] \times C [\mu\text{F}] \times \ln (V_{ON/OFF} [\text{V}] / (V_{ON/OFF} [\text{V}] - 1.8))$$

e.g. When $R_{SS} = 220\text{ k}\Omega$, $C_{SS} = 0.047\text{ }\mu\text{F}$, $V_{ON/OFF} = 2.7\text{ V}$, then $t_{SS} = 11.4\text{ ms}$.

3. ON/OFF pin (shutdown pin)

This pin deactivates or activates the step-down operation.

When the ON/OFF pin is set to "L", the V_{IN} voltage appears through the EXT pin, prodding the switching transistor to go off. All the internal circuits stop working, and substantial savings in current consumption are thus achieved.

The ON/OFF pin is configured as shown in **Figure 10**. Since pull-up or pull-down is not performed internally, please avoid operating the pin in a floating state. Also, try to refrain from applying a voltage of 0.3 to 1.8 V to the pin, lest the current consumption increase. When this ON/OFF pin is not used, leave it coupled to the VIN pin.

Table 7

ON/OFF Pin	CR Oscillation Circuit	Output Voltage
"H"	Activated	Set value
"L"	Deactivated	OPEN

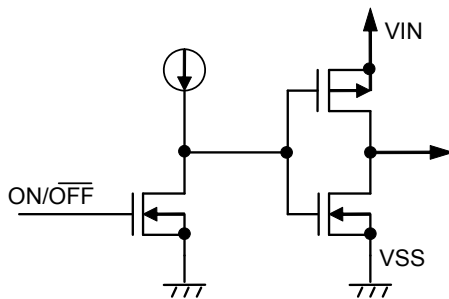

Figure 10

4. Current limit circuit

The S-8540/8541 series contains a current limit circuit.

The current limit circuit is designed to prevent thermal destruction of external transistors due to overload or magnetic saturation of the coil.

The current limit circuit can be enabled by inserting a SENSE resistor (R_{SENSE}) between the external coil and the output pin VOUT, and connecting the node for the SENSE resistor and the coil to the SENSE pin.

A current limit comparator in the IC is used to check whether the voltage between the SENSE pin and VOUT pin reaches the current limit detection voltage ($V_{SENSE} = 125 \text{ mV (typ.)}$). The current flowing through the external transistor is limited by turning it off during the left time of the oscillation period after detection. The transistor is turned on again at the next clock and current limit detection resumes. If the overcurrent state still persists, the current limit circuit operates again, and the process is repeated. If the overcurrent state is eliminated, the normal operation resumes. Slight overshoot occurs in the output voltage when the overcurrent state is eliminated.

Current limit setting value (I_{Limit}) is calculated by the following formula:

$$I_{Limit} = \frac{Vsense (= 125 \text{ mV})}{Rsense}$$

If the change with time of the current flowing through the sense resistor is higher than the response speed of the current limit comparator in the IC, the actual current limit value becomes higher than the I_{Limit} (current limit setting value) calculated by the above formula. When the voltage difference between VIN pin and VOUT pin is large, the actual current limit value increases since the change with time of the current flowing through the sense resistor becomes large.

4.1 V_{IN} vs. I_{peak} in the overcurrent state

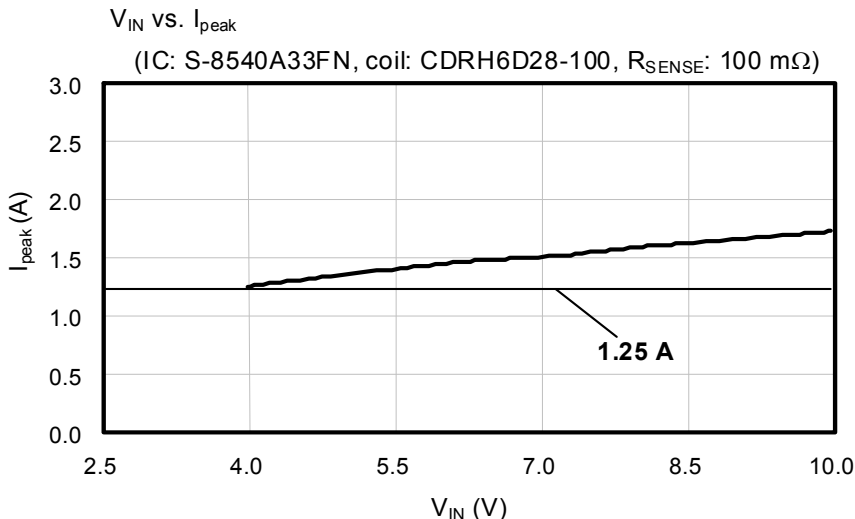

Figure 11 I_{peak} change by input voltage

When the output voltage is approximate 1.0 V or less, the load short-circuit protection does not work, since the current limit circuit does not operate.

When the current limit circuit is not used, remove the SENSE resistor and connect the SENSE pin to the VSS or VOUT pin.

5. 100% duty cycle

The S-8540/8541 series operates up to the maximum duty cycle of 100%. The switching transistor is kept on continuously to supply current to the load, when the input voltage falls below the preset output voltage value. The output voltage in this case is equal to the subtraction of lowering causes by DC resistance of the coil and on resistance of the switching FET from the input voltage.

Even when the duty cycle is 100%, the current limit circuit works when overcurrent flows.

■ **Selection of Series Products and Associated External Components**

1. Selecting a product

The S-8540/8541 series is classified into eight types according to the way of control (PWM and PWM/PFM switching), the oscillation frequencies, and output voltage settings (fixed and feed back). Please select the type that suits your needs best by taking the advantage described below into account.

1.1 Control method:

Two different control methods are available: PWM control (S-8540 series) and PWM/PFM switching control (S-8541 series).

1.2 Oscillation frequencies:

The oscillation frequencies are selectable in 600 kHz (A and B types) or 300 kHz (C and D types).

Because of their high oscillation frequency, the products in the A and B types allow the use of small size inductors since the peak current decreases when the same load current flows. In addition, they can also be used with small output capacitors. These outstanding features make the A and B types ideal for downsized devices.

On the other hand, the C and D types, having lower oscillation frequency, are characterized by small self-consumption current and excellent efficiency under light load.

1.3 Output voltage setting:

Two different types are available: fixed output (A and C types) and feed back type (B and D types).

Table 8 provides a rough guide for selecting a product depending on the requirements of the application. Choose the product that has the best score (○).

Table 8

	S-8540				S-8541			
	A	B	C	D	A	B	C	D
The set output voltage is fixed (1.5 to 6.0 V)	☆		☆		☆		☆	
Set an output voltage freely (1.5 to 6.0 V)		☆		☆		☆		☆
The efficiency at light load (less than 10 mA) is important.					○	○	○	○
The efficiency at 100 mA or more is important.			○	○			○	○
Low-ripple voltage is important.	○	○			○	○		
Use of small external parts is Important.	◎	◎			◎	◎		

Remark ☆ : Indispensable condition
 ○ : Superiority of requirement
 ◎ : Particularly superiority of requirement

2. Inductor

The inductance value (L) greatly affects the maximum output current (I_{OUT}) and the efficiency (η). The peak current (I_{PK}) increases by decreasing L and the stability of the circuit improves and I_{OUT} increases. If L is made even smaller, the efficiency falls causing a decline in the current drive capacity for the switching transistor, and I_{OUT} decreases.

The loss of I_{PK} by the switching transistor decreases by increasing L and the efficiency becomes maximum at a certain L value. Increasing L further decreases the efficiency due to the loss of coil DC resistance. I_{OUT} also decreases.

When the inductance is large in an S-8540/8541 series product, the output voltage may grow unstable in some cases, depending on the conditions of the input voltage, output voltage, and the load current. Perform sufficient evaluation under the actual condition and decide an optimum inductance.

The recommended inductances are 10 μ H for A, B types and 22 μ H for C, D types.

When choosing an inductor, attention to its allowable current should be paid since the current over the allowable value will cause magnetic saturation in the inductor, leading to a marked decline in efficiency.

An inductor should therefore be selected so as not I_{PK} to surpass its allowable current. The peak current (I_{PK}) is represented by the following equation in non-continuous operation mode:

$$I_{PK} = I_{OUT} + \frac{V_{OUT} \times (V_{IN} - V_{OUT})}{2 \times f_{OSC} \times L \times V_{IN}}$$

Where f_{OSC} is the oscillation frequency.

3. Diode

The diode to be externally coupled to the IC should be a type that meets the following conditions:

- The forward voltage is low (Schottky barrier diode recommended).
- The switching speed is high (50 ns max.).
- The reverse direction voltage is higher than V_{IN} .
- The current rating is larger than I_{PK} .

4. Capacitors

4.1 Capacitors (C_{IN} , C_{OUT})

The capacitor inserted in the input side (C_{IN}) serves to reduce the power impedance and to average the input current for better efficiency. The C_{IN} value should be selected according to the impedance of the power supply. It should be 47 to 100 μ F, although the actual value depends on the impedance of the power source used and load current value.

For the output side capacitor (C_{OUT}), select a large capacitance with low ESR (Equivalent Series Resistance) to smoothen the ripple voltage. When the input voltage is extremely high or the load current is extremely large, the output voltage may become unstable. In this case the unstable area will become narrow by selecting a large capacitance for an output side capacitor. A tantalum electrolytic capacitor is recommended since the unstable area widens when a capacitor with a large ESR, such as an aluminum electrolytic capacitor, or a capacitor with a small ESR, such as a ceramic capacitor, is chosen. The range of the capacitance should generally be 47 to 100 μ F.

4.2 Internal power source stabilization capacitor (C_{VL})

The main circuits of the IC work on an internal power source connected to the CVREF pin. The C_{VL} is a bypass capacitor for stabilizing the internal Power source. C_{VL} should be a 1 μ F ceramic capacitor and wired in a short distance and at a low impedance.

5. External transistor

The S-8540/8541 series can work with an enhancement (Pch) MOS FET or a bipolar (PNP) transistor as an external transistor.

5.1 Enhancement (Pch) MOS FET

The EXT pin can directly drive the Pch MOS FET with a gate capacity of approximate 1200 pF.

When a Pch MOS FET is chosen, efficiency will be 2 to 3 % higher than that achieved by a PNP bipolar transistor since the MOS FET switching speed is faster than that of the bipolar transistor and power loss due to the base current is avoided.

The important parameters in selecting a Pch MOS FET are the threshold voltage, breakdown voltage between gate and source, breakdown voltage between drain and source, total gate capacity, on-resistance, and the current ratings.

The EXT pin swings from voltage V_{IN} to V_{SS} . When the input voltage is low, a MOS FET with a low threshold voltage has to be used so that the MOS FET will turn on as required. When, conversely, the input voltage is high, select a MOS FET whose gate-source breakdown voltage is higher than the input voltage by at least several volts.

Immediately after the power is turned on, or the power is turned off (that is, when the step-down operation is terminated), the input voltage is applied across the drain and the source of the MOS FET. The transistor therefore needs to have drain-source breakdown voltage that is also several volts higher than the input voltage.

The total gate capacity and the on-resistance affect the efficiency.

The power loss for charging and discharging the gate capacity by switching operation will affect the efficiency at low load current region more when the total gate capacity becomes larger and the input voltage becomes higher. If the efficiency at low load is a matter of concern, select a MOS FET with a small total gate capacity.

In regions where the load current is high, the efficiency is affected by power loss caused by the on-resistance of the MOS FET. If the efficiency under heavy load is particularly important in the application, choose a MOS FET having on-resistance as low as possible.

As for the current rating, select a MOS FET whose maximum continuous drain current rating is higher than I_{PK} .

5.2 Bipolar (PNP) transistor

Figure 12 shows a circuit diagram using Toshiba Corporation 2SA1213-Y for the bipolar transistor (PNP). Using a bipolar transistor, the driving capacity for increasing the output current is determined by the h_{FE} value and the R_b value.

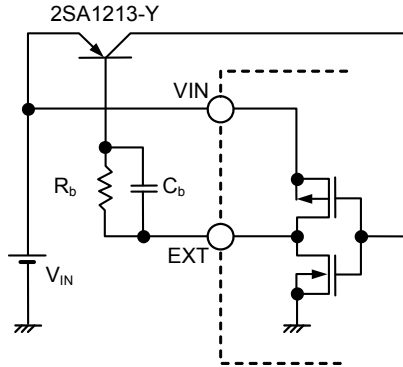

Figure 12

The R_b value is given by the following equation:

$$R_b = \frac{V_{IN} - 0.7}{I_b} - \frac{0.4}{|I_{EXTL}|}$$

Calculate the necessary base current I_b using the h_{FE} value of the bipolar transistor from the relation, $I_b = I_{PK}/h_{FE}$, and select a smaller value for R_b which is calculated from the above equation.

A small R_b value will certainly contribute to increase the output current, but it will also decrease the efficiency. Determine the optimum value through experiment since the base current flows as pulses and voltage drop may take place due to the wiring resistance and so on.

In addition, if speed-up capacitor C_b is inserted in parallel with resistance R_b , as shown in Figure 12, the switching loss will be reduced, leading to a higher efficiency.

by using the following equation :

$$C_b \leq \frac{1}{2\pi \times R_b \times f_{OSC} \times 0.7}$$

Select a C_b value after performing sufficient evaluation since the optimum C_b value differs depending upon the characteristics of the bipolar transistor.

■ Precautions

- Install the external capacitors, diode, coil, and other peripheral components as close to the IC as possible, and make a one-point grounding.

When the input voltage is 9 to 10 V, V_{OUT} may vary largely according to the grounding method.

When it is difficult to make one-point grounding, use two grounds: one for V_{IN} , C_{IN} , and SD GND, and the other for V_{OUT} , V_{CVREF} , and IC GND.

- Characteristics ripple voltage and spike noise occur in IC containing switching regulators. Moreover rush current flows at the time of a power supply injection. Because these largely depend on the inductor, the capacitor and impedance of power supply used, fully check them using an actually mounted model.
- If the input voltage is high and output current is low, pulses with a low duty ratio may appear, and then the 0% duty ratio continues for several clocks. In this case the operation changes to the pseudo pulse frequency modulation (PFM) mode, but the ripple voltage hardly increases.
- If the input power supply voltage is lower than 1.0 V, the IC operation is unstable and the external switch may be turned on.

If input power supply voltage is 10.0 V or higher, the circuit operation is unstable and the IC may be damaged.

The input voltage must be in the standard range (2.5 to 10.0 V).

- The current limit circuit of the IC limits current by detecting a voltage difference of external resistor R_{SENSE} . In choosing the components, make sure that overcurrent will not surpass the allowable dissipation of the switching transistor and the inductor.
- Make sure that dissipation of the switching transistor will not surpass the allowable power dissipation of the package (especially at high temperature).
- Do not apply an electrostatic discharge to this IC that exceeds the performance ratings of the built-in electrostatic protection circuit.
- ABLIC Inc. shall bear no responsibility for any patent infringement by a product that includes an IC manufactured by ABLIC Inc. in relation to the method of using the IC in that product, the product specifications, or the destination country.

■ **Application Circuits**

1. **External adjustment of output voltage**

The output voltage can be adjusted or changed in the output voltage setting range (1.5 to 6.0 V) by adding external resistors (R_A , R_B) and a capacitor (C_{FB}) in the S-8540/8541B00AFN and S-8540/8541D00AFN, as shown in **Figure 15**. Temperature gradient can be given by inserting a thermistor in series to R_A and R_B .

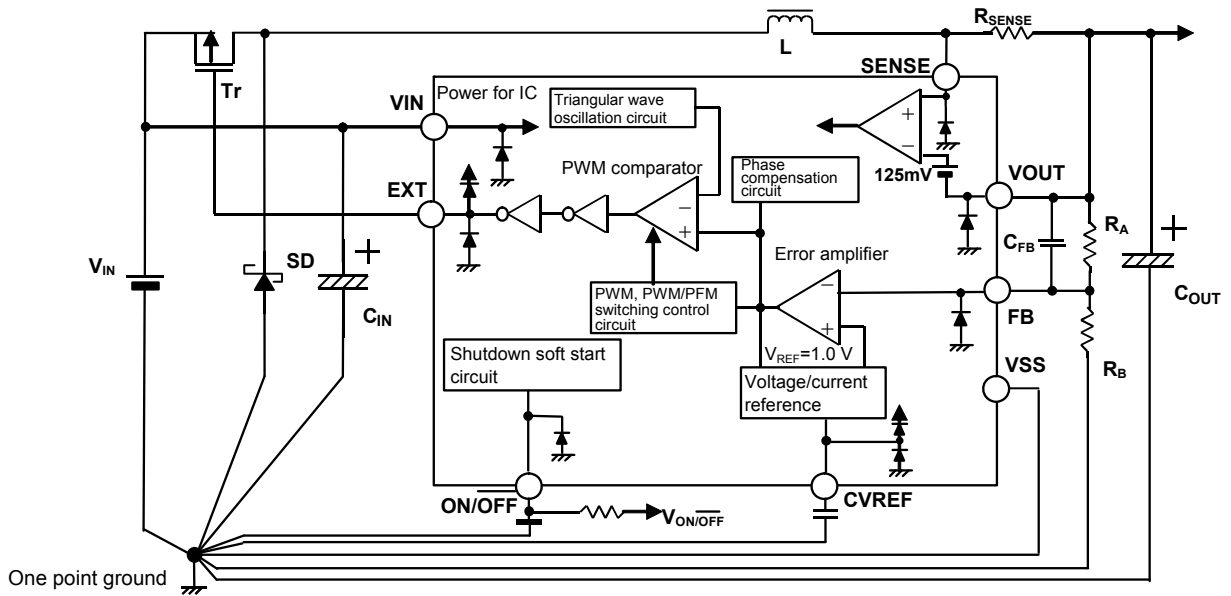

Figure 15

Caution The above connection diagram and constant will not guarantees successful operation. Perform through evaluation using the actual application to set the constant.

R_A , R_B must be $R_A + R_B \leq 2 \text{ M}\Omega$ and the ratio of R_A to R_B should be set so that the FB pin is 1.0 V. Add a capacitor (C_{FB}) in parallel to R_A to prevent unstable operation like output oscillation.

Set the C_{FB} so that $f = 1/(2 \times \pi C_{FB} \times R_A)$ is 0.1 to 20 kHz (normally 10 kHz).

e.g. When $V_{OUT} = 3.0 \text{ V}$, $R_A = 200 \text{ k}\Omega$, $R_B = 100 \text{ k}\Omega$, then $C_{FB} = 100 \text{ pF}$.

The precision of output voltage (V_{OUT}) determined by R_A , R_B is affected by the precision of the voltage at the FB pin ($1 \text{ V} \pm 2.0\%$), the precision of R_A and R_B , current input to the FB pin, and IC power supply voltage V_{DD} .

Suppose that the FB pin input current is 0 nA, and that the maximum absolute values of the external resistors R_A and R_B are $R_{A \text{ max.}}$ and $R_{B \text{ max.}}$, and the minimum absolute values of the external resistors R_A and R_B are $R_{A \text{ min.}}$ and $R_{B \text{ min.}}$, and that the output voltage shift due to the V_{DD} voltage dependency is ΔV , the minimum value $V_{OUT \text{ min.}}$ and maximum value $V_{OUT \text{ max.}}$ of the output voltage V_{OUT} variation is calculated by the following formula:

$$V_{OUT \text{ min.}} = \left(1 + \frac{R_{A \text{ min.}}}{R_{B \text{ max.}}}\right) \times 0.98 - \Delta V \text{ [V]}$$

$$V_{OUT \text{ max.}} = \left(1 + \frac{R_{A \text{ max.}}}{R_{B \text{ min.}}}\right) \times 1.02 + \Delta V \text{ [V]}$$

The precision of the output voltage V_{OUT} cannot be made lower than the precision of the IC output voltage without adjustment of external resistors R_A and R_B . The lower the R_A/R_B , the less it is affected by the absolute value precision of the external resistors R_A and R_B . The lower the R_A and R_B , the less it is affected by the FB pin input current.

To suppress the influence of FB pin input current on the variation of output voltage V_{OUT} , the external resistor R_B value must be made sufficiently lower than the input impedance of the FB pin, $1 \text{ V}/50 \text{ nA} = 20 \text{ M}\Omega$ max.

Waste current flows through external resistors R_A and R_B . When it is not a negligible value with respect to load current in actual use, the efficiency decreases. The R_A and R_B values of the external resistors must therefore be made sufficiently high.

Evaluation of the influence of the noise is needed in the actual condition If the R_A and R_B values of resistors are high ($1 \text{ M}\Omega$ or higher) since they are susceptible to external noise.

The output voltage V_{OUT} precision and the waste current are in a trade-off relation. They must be considered according to application requests.

■ **Typical Characteristics**

1. **Examples of major parameters characteristics**

(1) $I_{SS1} - V_{IN}$ S-8540/8541(300 kHz)

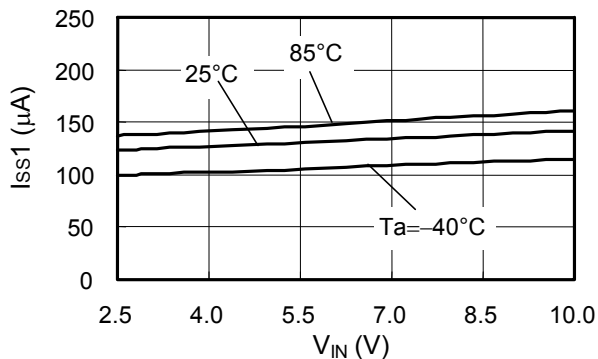

(2) $I_{SS1} - V_{IN}$ S-8540/8541(600 kHz)

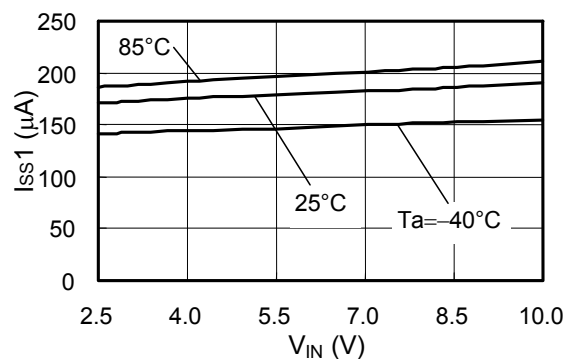

(3) $f_{OSC} - V_{IN}$ S-8540/8541(300 kHz)

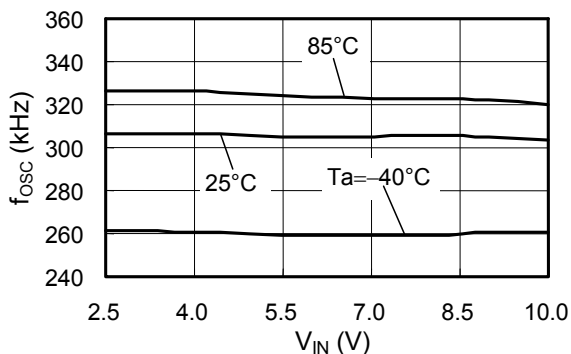

(4) $f_{OSC} - V_{IN}$ S-8540/8541(600 kHz)

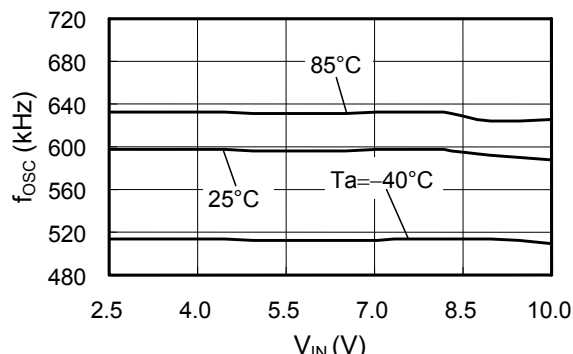

(5) $I_{EXTH} - V_{IN}$ S-8540/8541

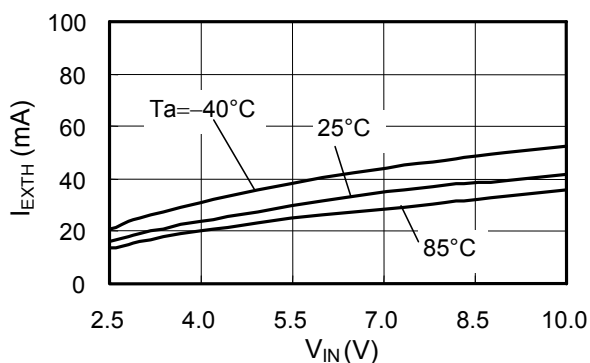

(6) $I_{EXTL} - V_{IN}$ S-8540/8541

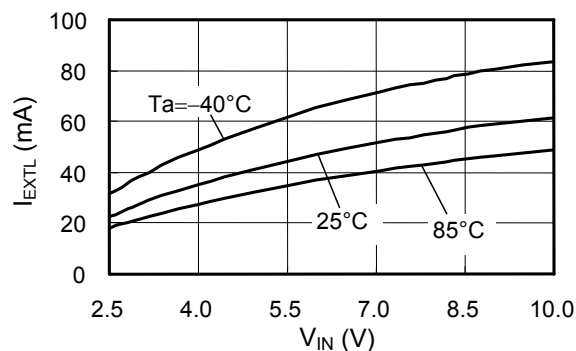

(7) $V_{SH} - V_{IN}$ S-8540/8541

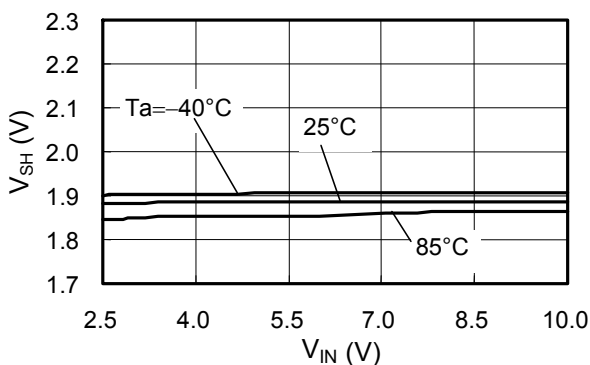

(8) $V_{SL} - V_{IN}$ S-8540/8541

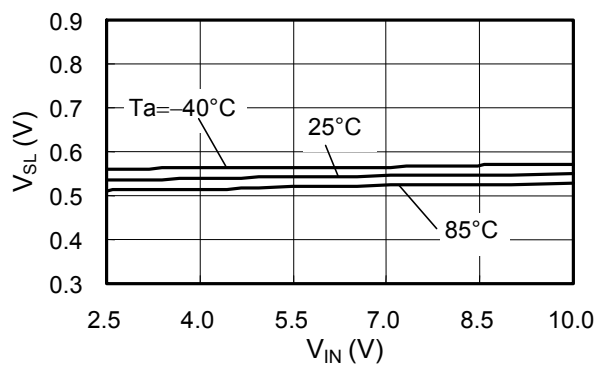

(9) $t_{SS} - V_{IN}$

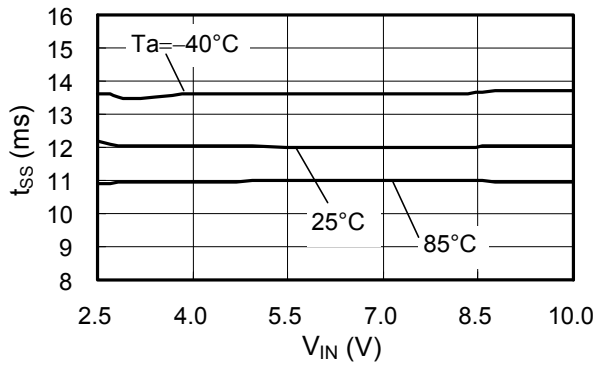

(10) $V_{OUT} - V_{IN}$ 1.8 V PWM/PFM 600 kHz

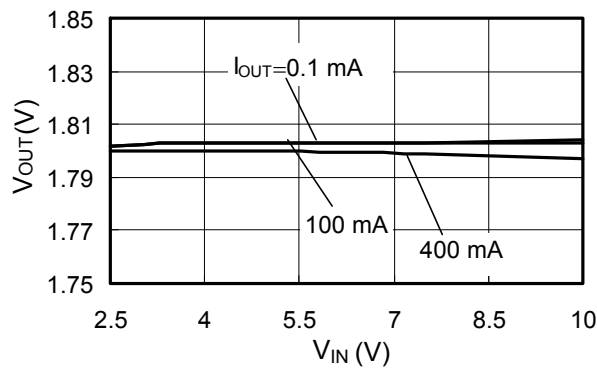

(11) $V_{OUT} - V_{IN}$ 3.3 V PWM/PFM 600 kHz

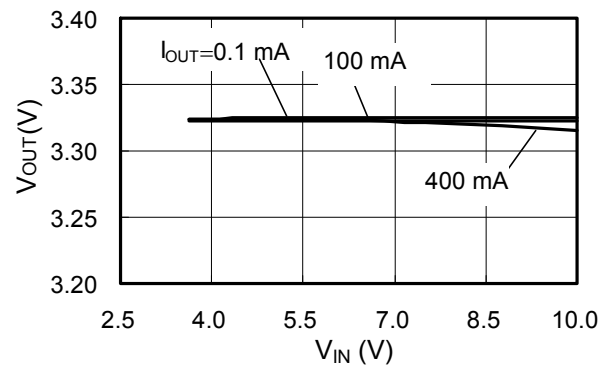

(12) $V_{OUT} - V_{IN}$ 3.3 V PWM 600 kHz

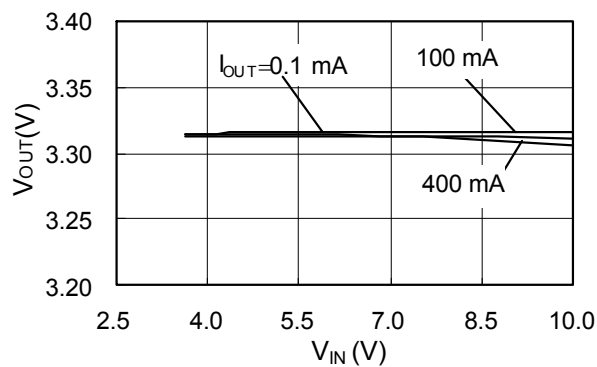

(13) $V_{OUT} - V_{IN}$ 3.3 V PWM/PFM 300 kHz

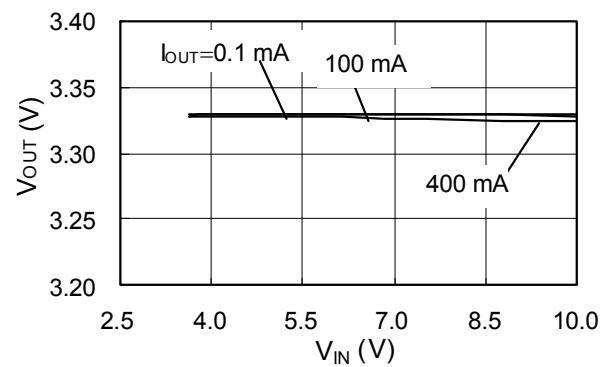

2. Transient Response Characteristics

2.1 Power-on (I_{OUT} : no Load)

(1) S-8540A33FN (V_{IN} : 0 \rightarrow 4.95 V)

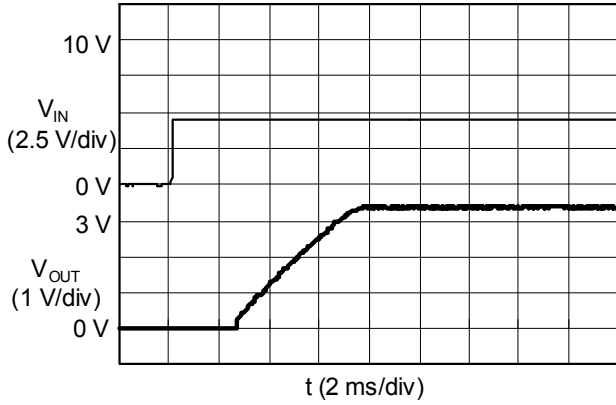

(2) S-8540A33FN (V_{IN} : 0 \rightarrow 10 V)

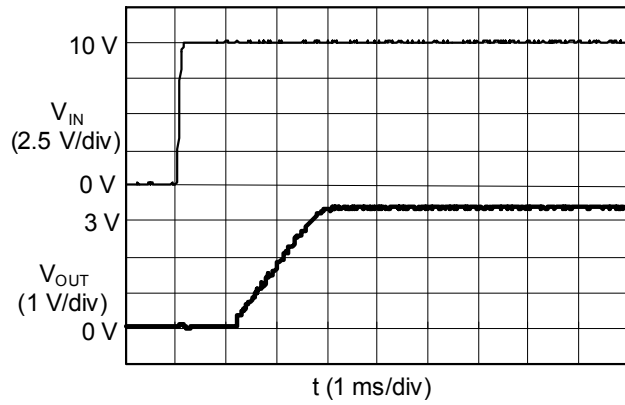

(3) S-8540C33FN (V_{IN} : 0 \rightarrow 4.95 V)

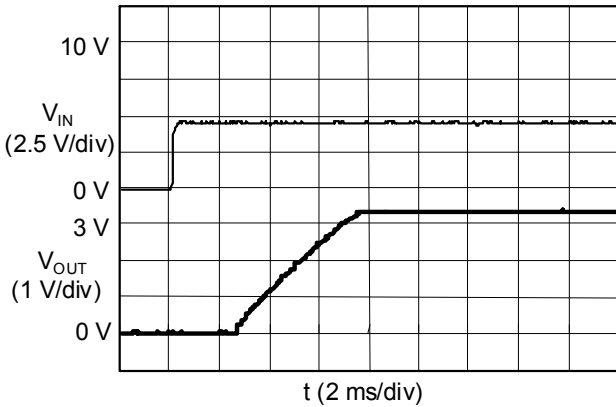

(4) S-8540C33FN (V_{IN} : 0 \rightarrow 10 V)

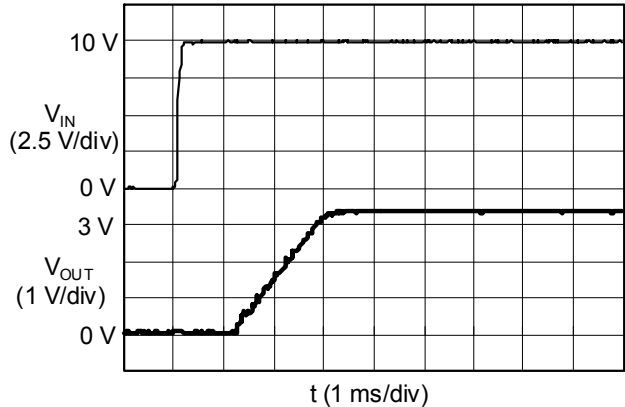

(5) S-8540A18FN (V_{IN} : 0 \rightarrow 2.7 V)

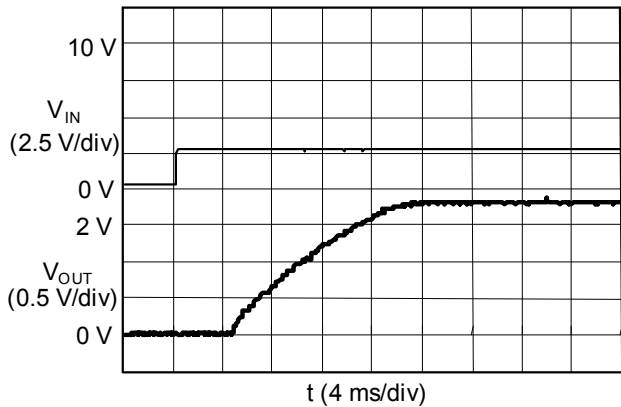

(6) S-8540A18FN (V_{IN} : 0 \rightarrow 10 V)

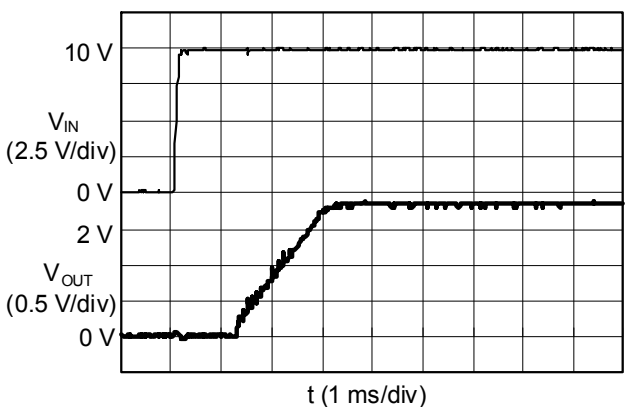

2.2 Shutdown pin response ($V_{ON/OFF} : 0 \rightarrow 2.5 \text{ V}$ $I_{OUT} : \text{no Load}$)

(1) S-8540A33FN ($V_{IN} : 4.95\text{V}$)

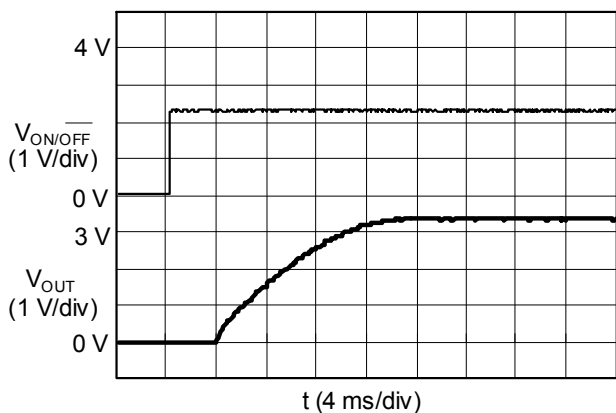

(2) S-8540A33FN ($V_{IN} : 10\text{V}$)

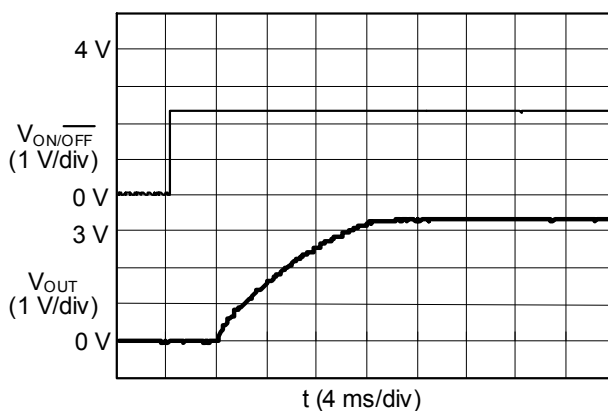

(3) S-8540C33FN ($V_{IN} : 4.95 \text{ V}$)

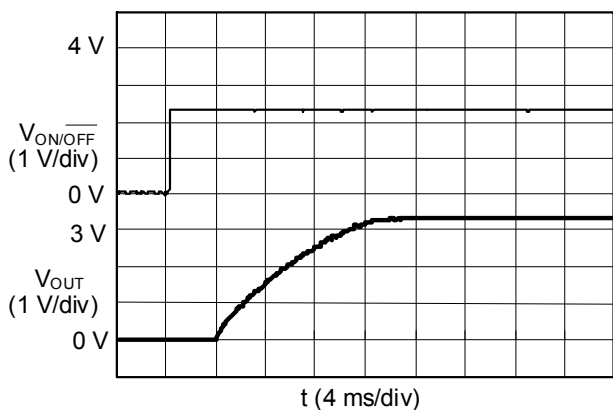

(4) S-8540C33FN ($V_{IN} : 10 \text{ V}$)

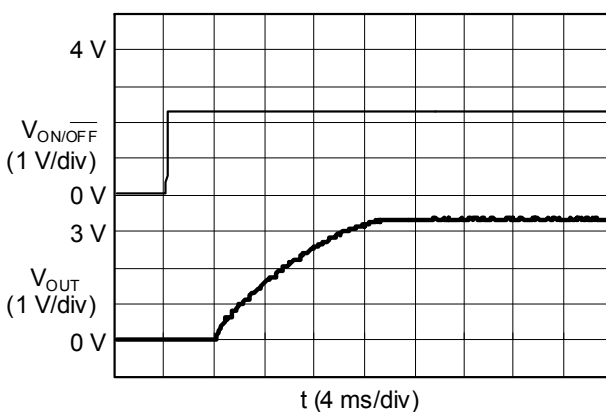

(5) S-8540A18FN ($V_{IN} : 4.95 \text{ V}$)

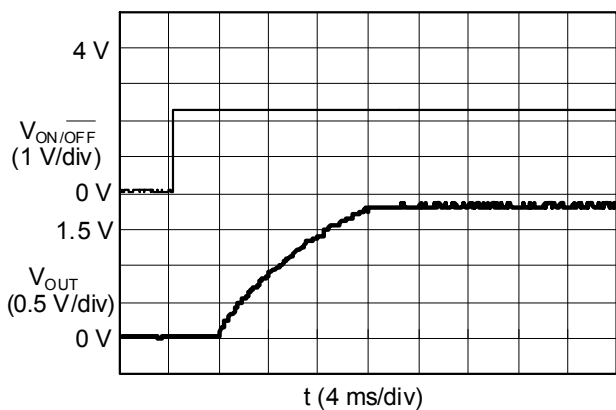

(6) S-8540A18FN ($V_{IN} : 10 \text{ V}$)

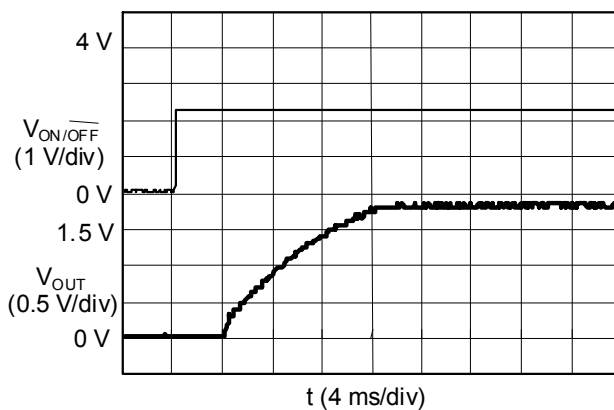

2.3 Supply Voltage Variation (V_{IN} : 3.6→9.0→3.6 V)

(1) S-8540A33FN (I_{OUT} : 10 mA)

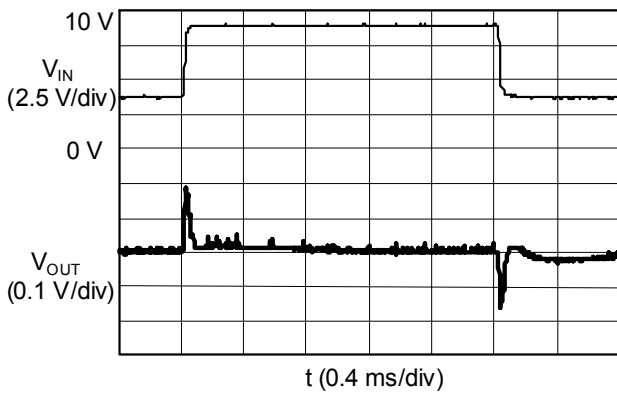

(2) S-8540A33FN (I_{OUT} : 500 mA)

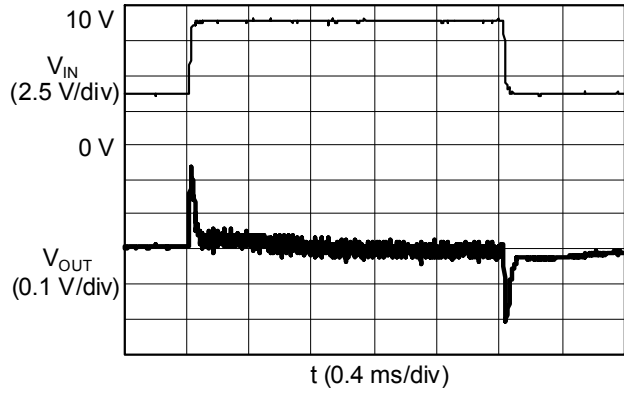

(3) S-8540C33FN (I_{OUT} : 10 mA)

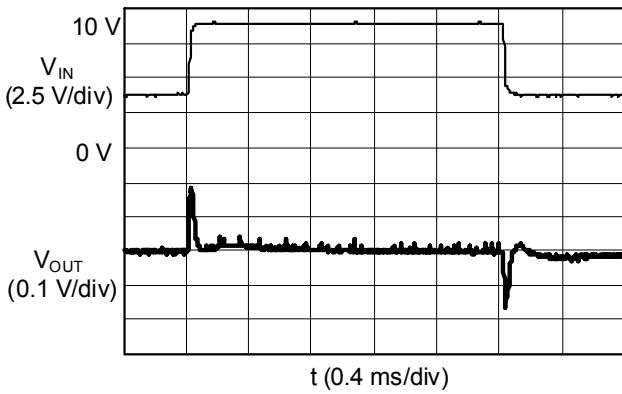

(4) S-8540C33FN (I_{OUT} : 500 mA)

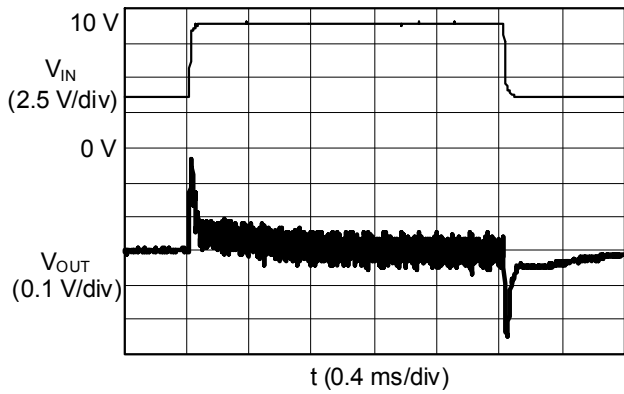

(5) S-8540A18FN (I_{OUT} : 10 mA)

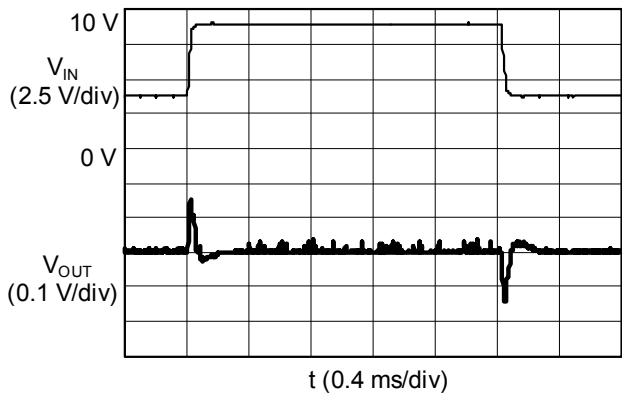

(6) S-8540A18FN (I_{OUT} : 500 mA)

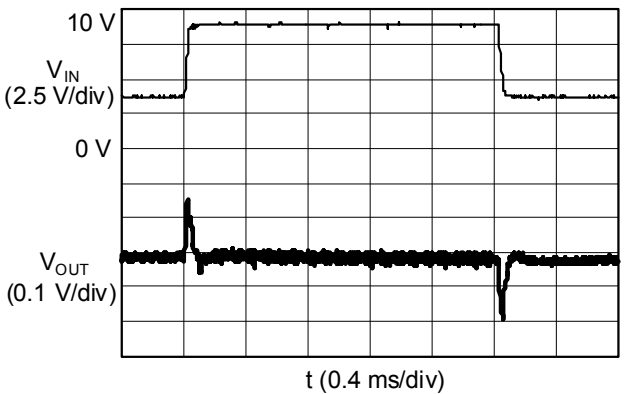

2.4 Load Variation (V_{IN} : 2.7 V or 5.0 V or 7.5 V, I_{OUT} : 0.1→500 mA, 500→0.1 mA)

(1) S-8540A33FN (V_{IN} : 4.95 V)

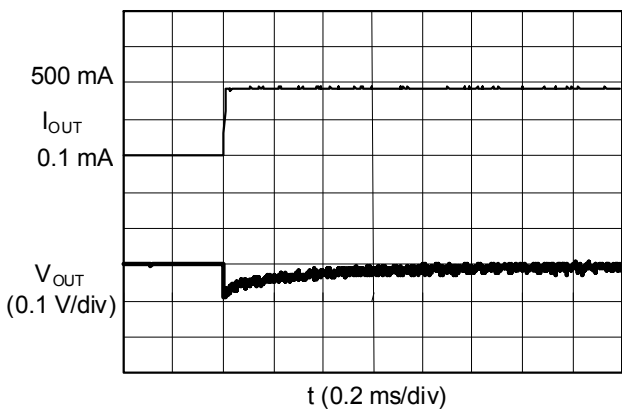

(2) S-8540A33FN (V_{IN} : 4.95 V)

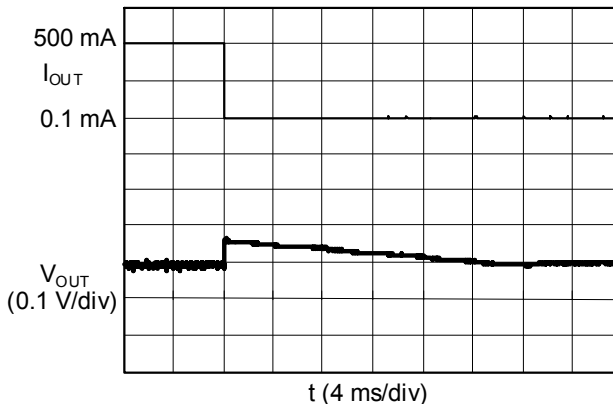

(3) S-8540C33FN (V_{IN} : 4.95 V)

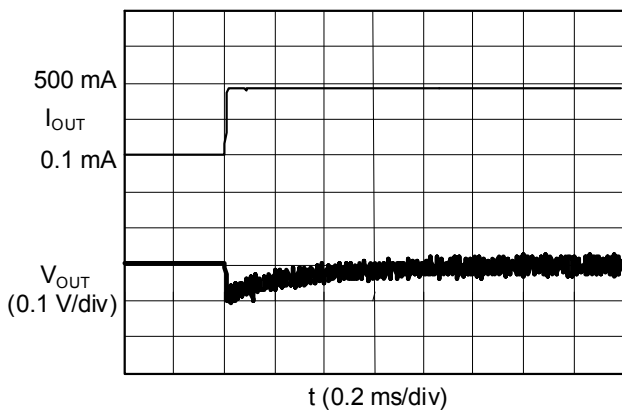

(4) S-8540C33FN (V_{IN} : 4.95 V)

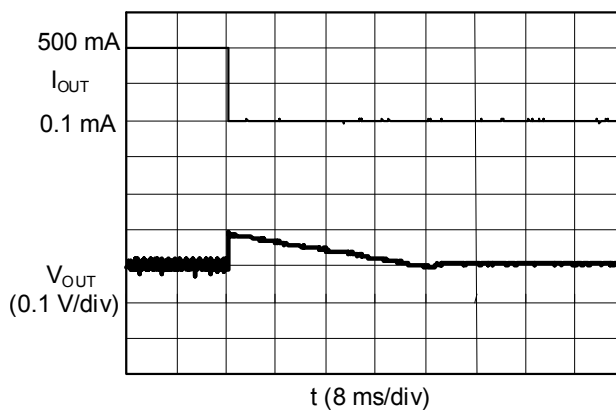

(5) S-8540A18FN (V_{IN} : 2.7 V)

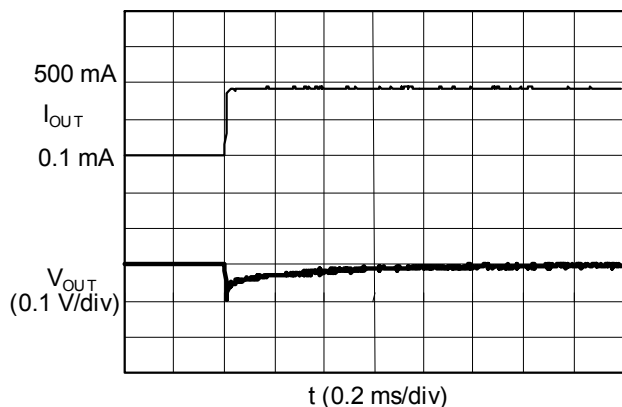

(6) S-8540A18FN (V_{IN} : 2.7 V)

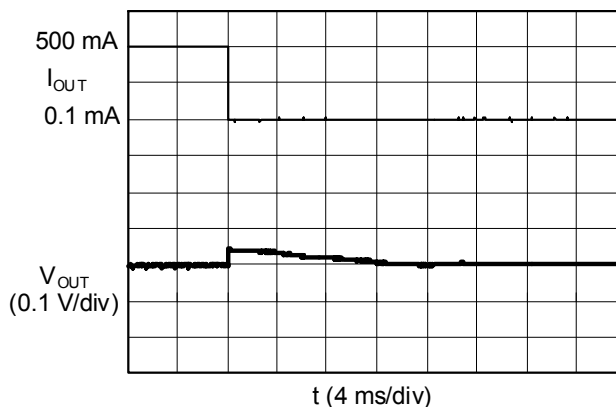

■ Reference Data

This reference data is intended to help you select peripheral components to be externally connected to the IC. Therefore, this information provides recommendations on external components selected with a view to accommodating a wide variety of IC applications. Characteristic data is duly indicated in the table below.

Table 9. External components list for efficiency

(Small and thin application using 1.3 mm or less tall components, maximum load current : I_{OUT} = 0.9 A)

No.	Product Name	Output Voltage	Modulation	f _{osc}	Inductor	Transistor	Diode	Output Capacitor
1.1	S-8540A33FN	3.3 V	PWM	600kHz	LDR655312T-4R7	CPH6301	RB491D	F920J476MB × 2
1.2	S-8541A33FN		PWM/PFM					
1.3	S-8540A25FN	2.5 V	PWM					
1.4	S-8541A25FN		PWM/PFM					
1.5	S-8540A18FN	1.8 V	PWM					
1.6	S-8541A18FN		PWM/PFM					

Table 10 External components list for efficiency

(High efficiency application using 3.0mm or less tall components, maximum load current : I_{OUT} = 1.0 A)

No.	Product Name	Output Voltage	Modulation	f _{osc}	Inductor	Transistor	Diode	Output Capacitor
1.7	S-8540C33FN	3.3 V	PWM	300kHz	CDRH6D28-220	CPH6301	RB491D	F931A476MC × 1
1.8	S-8541C33FN		PWM/PFM					
1.9	S-8540C25FN	2.5 V	PWM					
1.10	S-8541C25FN		PWM/PFM					
1.11	S-8540C18FN	1.8 V	PWM					
1.12	S-8541C18FN		PWM/PFM					

Table 11 External components list for ripple voltage

No.	Product Name	Output Voltage	Modulation	f _{osc}	Inductor	Transistor	Diode	Output Capacitor					
2.1	S-8540A33FN	3.3 V	PWM	600kHz	LDR655312T-4R7	CPH6301	RB491D	F920J476MB × 2					
2.2	S-8541A33FN		PWM/PFM										
2.3	S-8540A18FN	1.8 V	PWM										
2.4	S-8541A18FN		PWM/PFM										
2.5	S-8540C33FN	3.3 V	PWM						300kHz	CDRH6D28-220	CPH6301	RB491D	F931A476MC × 1
2.6	S-8541C33FN		PWM/PFM										
2.7	S-8540C18FN	1.8 V	PWM										
2.8	S-8541C18FN		PWM/PFM										

Table 12 External parts function

Component	Product Name	Manufacturer	L-Value	DC Resistance	Maximum Current	Size (L × W × H) [mm]
Inductor	LDR655312T-4R7	TDK Corporation	4.7 μH	0.19 Ω	0.9 A	6.5 × 5.3 × 1.25
	CDRH6D28-220	Sumida Corporation	22.0 μH	0.128 Ω	1.2 A	7.0 × 7.0 × 3.0
Diode	RB491D	Rohm Corporation	Forward current 1.0 A at $V_F = 0.45\text{ V}$, $V_m = 25\text{ V}$			3.0 × 3.1 × 1.3
Output Capacity (tantalum electrolytic)	F920J476MB	Nichicon Corporation	47 μF, 6.3 V			3.6 × 3.0 × 1.2
	F931A476MC	Nichicon Corporation	47 μF, 10.0 V			6.2 × 3.4 × 2.7
Transistor (MOS FET)	CPH6301	Sanyo Electric Co., Ltd.	$V_{ds} = 20\text{ V max.}$, $V_{gs} = 10\text{ V max.}$, $I_D = 3.0\text{ A max.}$, $C_{iss} = 360\text{ pF}$, $R_{on} = 110\text{ m}\Omega$			2.9 × 2.8 × 0.9

1. Efficiency Characteristics : Efficiency (η) – Output current (I_{OUT})

1.1 S-8540A33FN

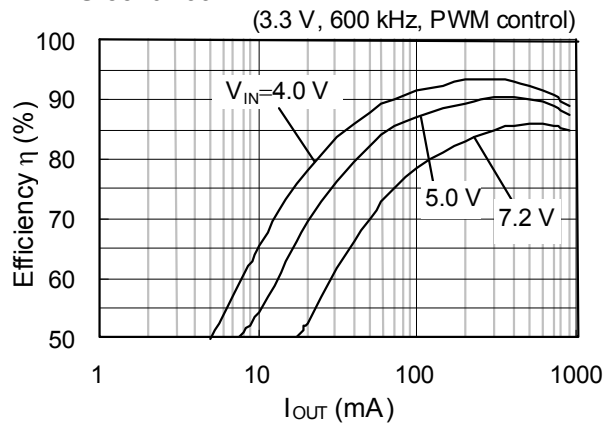

1.2 S-8541A33FN

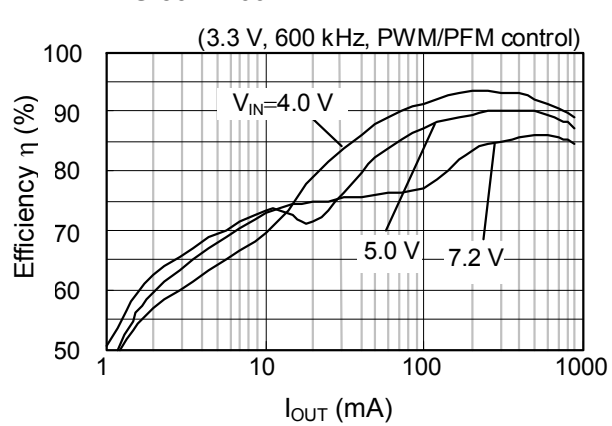

1.3 S-8540A25FN

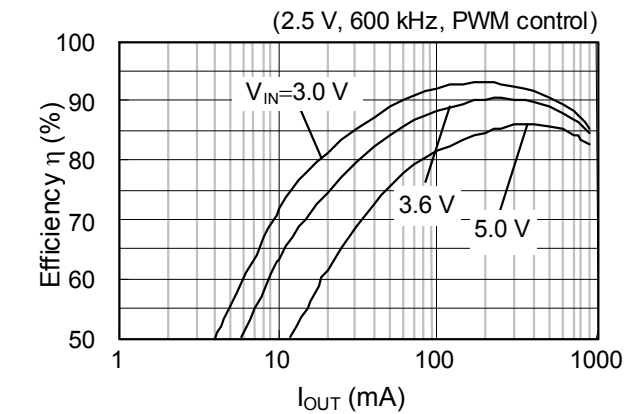

1.4 S-8541A25FN

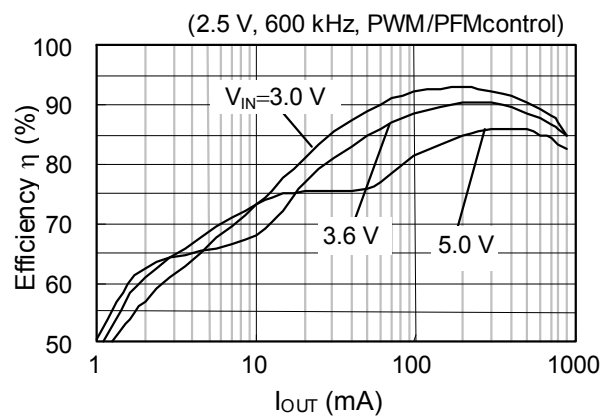

1.5 S-8540A18FN

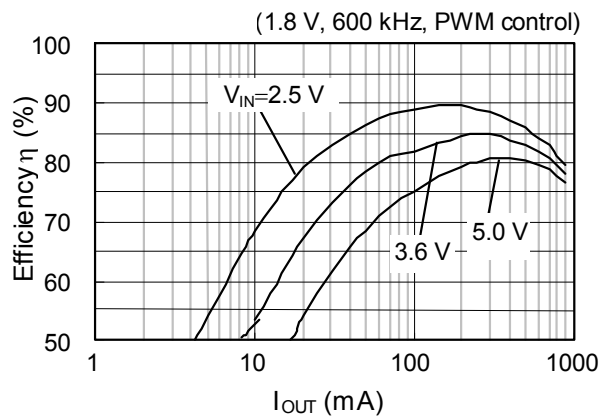

1.6 S-8541A18FN

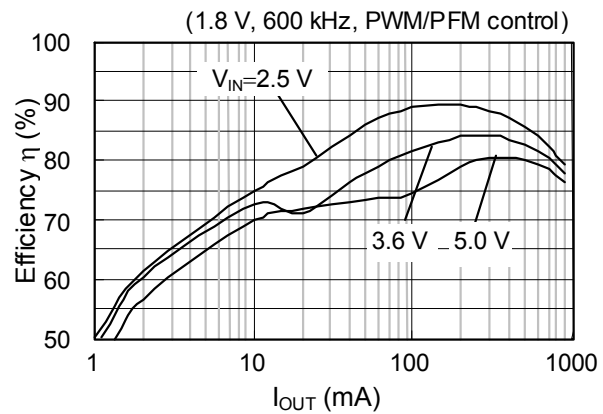

1.7 S-8540C33FN

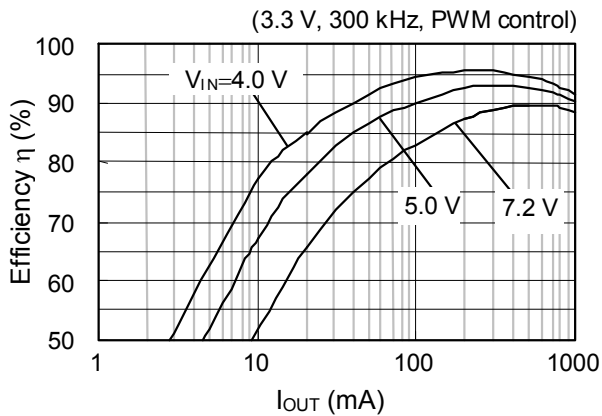

1.8 S-8541C33FN

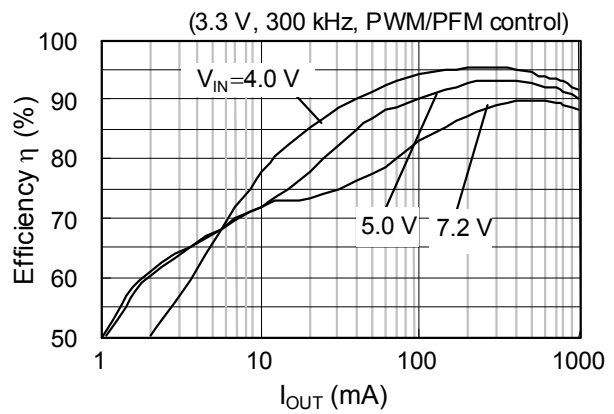

1.9 S-8540C25FN

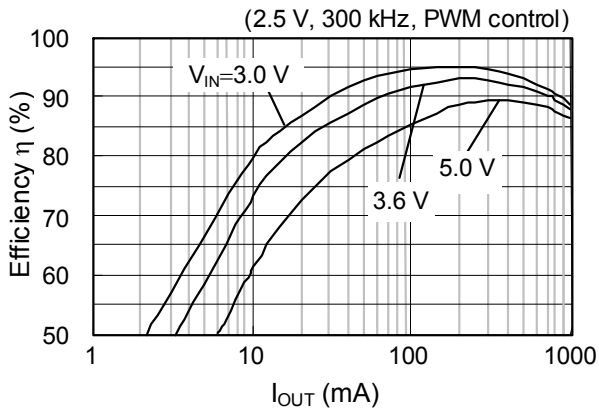

1.10 S-8541C25FN

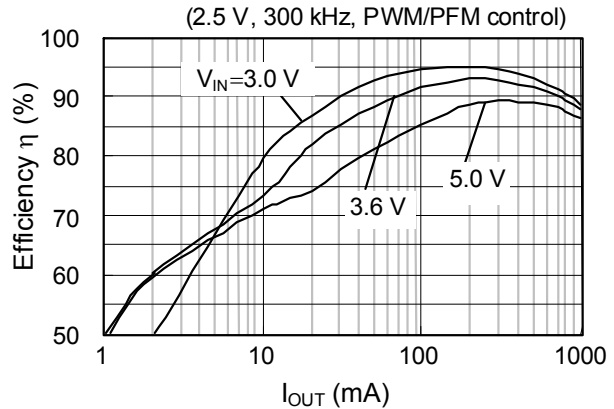

1.11 S-8540C18FN

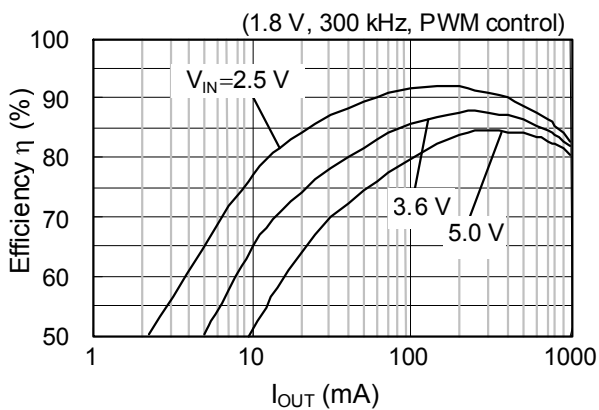

1.12 S-8541C18FN

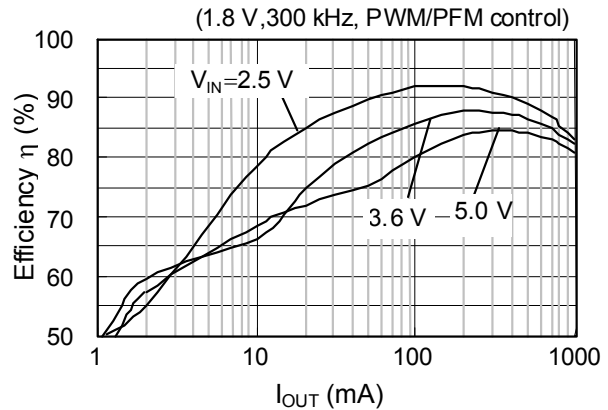

2. Ripple Voltage (V_{rip}) – Output Current (I_{OUT}) Characteristics

2.1 S-8540A33FN

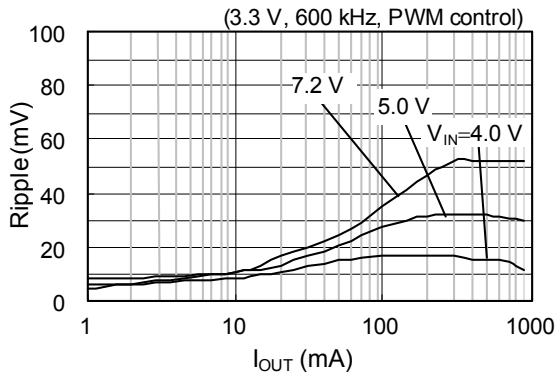

2.2 S-8541A33FN

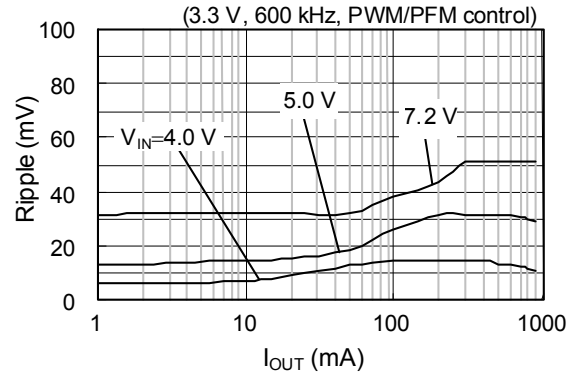

2.3 S-8540A18FN

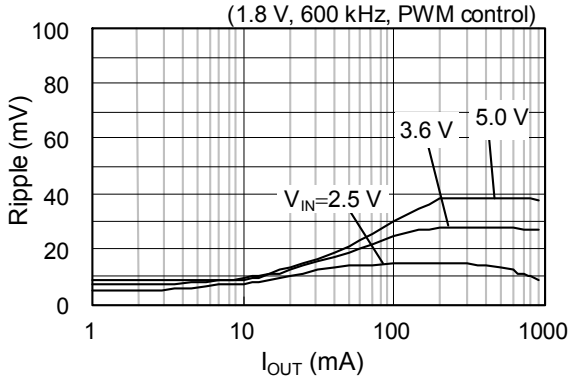

2.4 S-8541A18FN

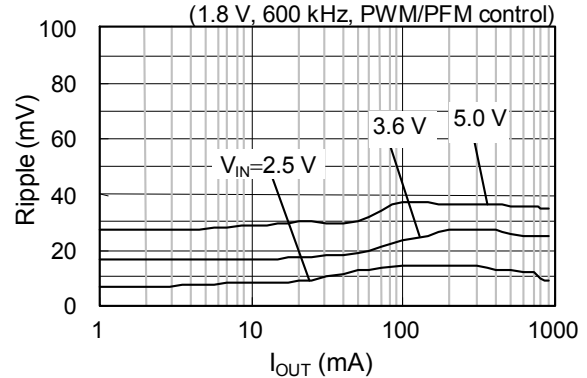

2.5 S-8540C33FN

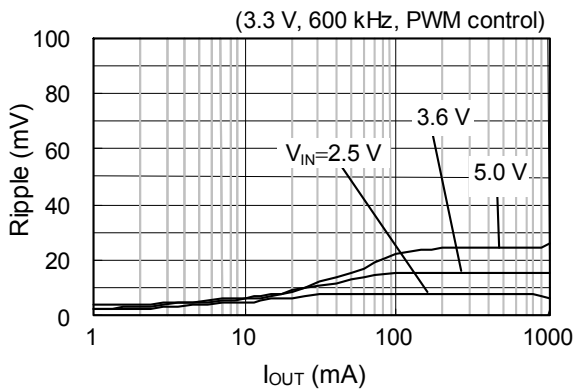

2.6 S-8541C33FN

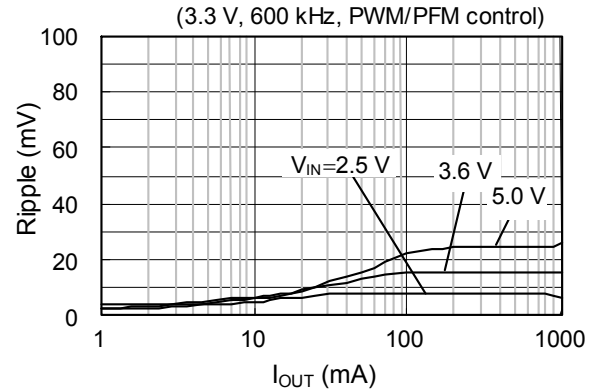

2.7 S-8540C18FN

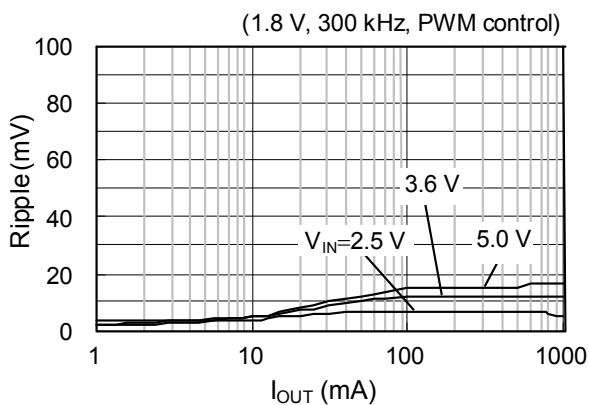

2.8 S-8541C18FN

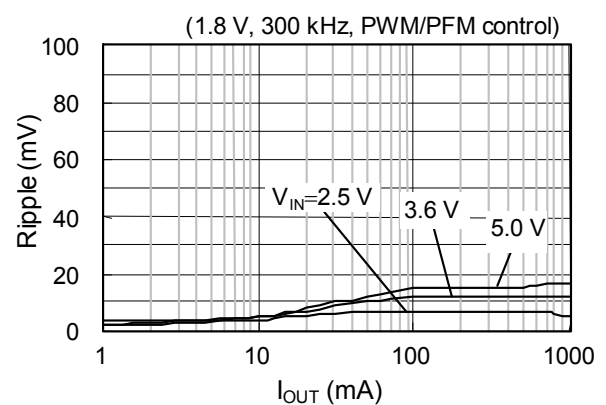

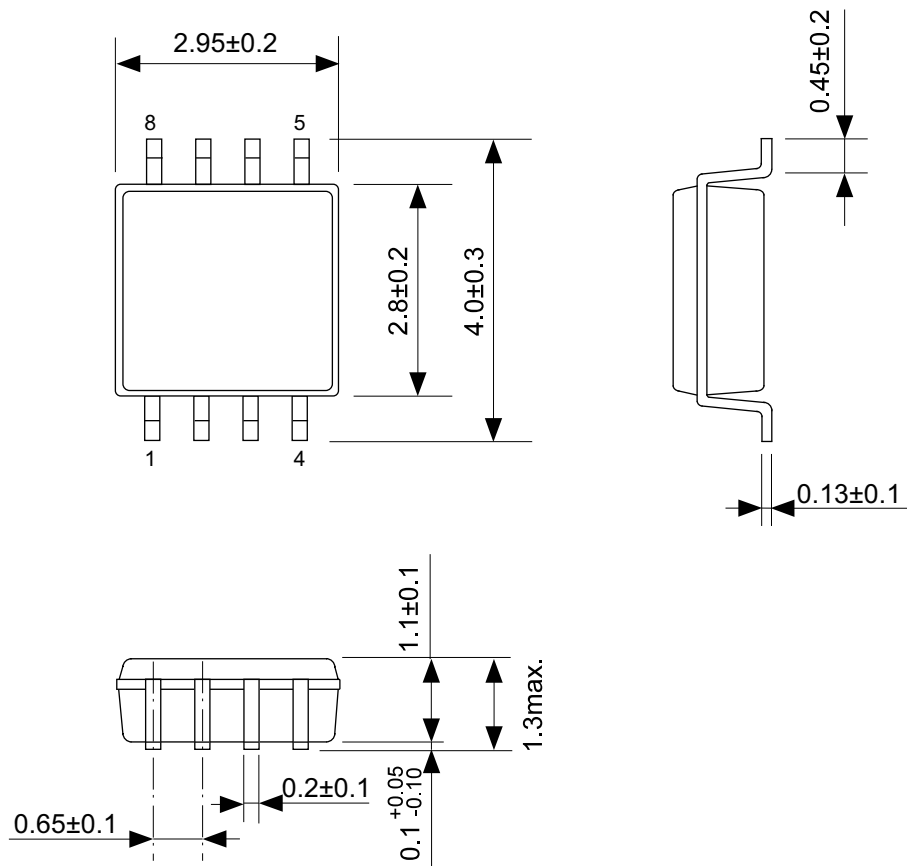

No. FN008-A-P-SD-1.2

TITLE	MSOP8-A-PKG Dimensions
No.	FN008-A-P-SD-1.2
ANGLE	
UNIT	mm
ABLIC Inc.	

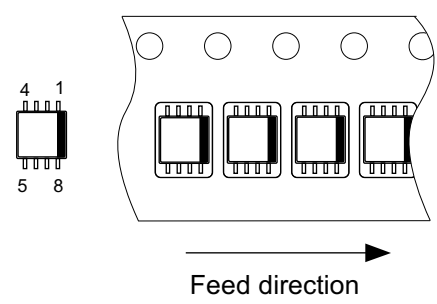
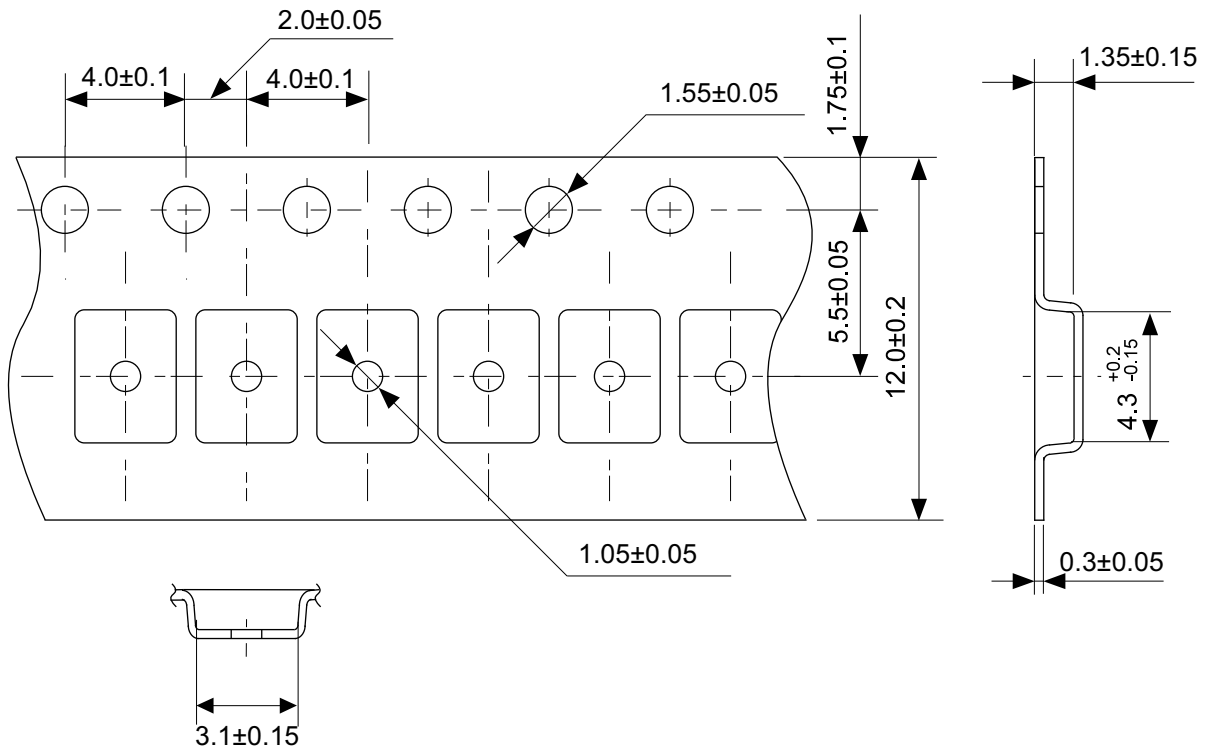

No. FN008-A-C-SD-1.1

TITLE	MSOP8-A-Carrier Tape
No.	FN008-A-C-SD-1.1
ANGLE	
UNIT	mm
ABLIC Inc.	

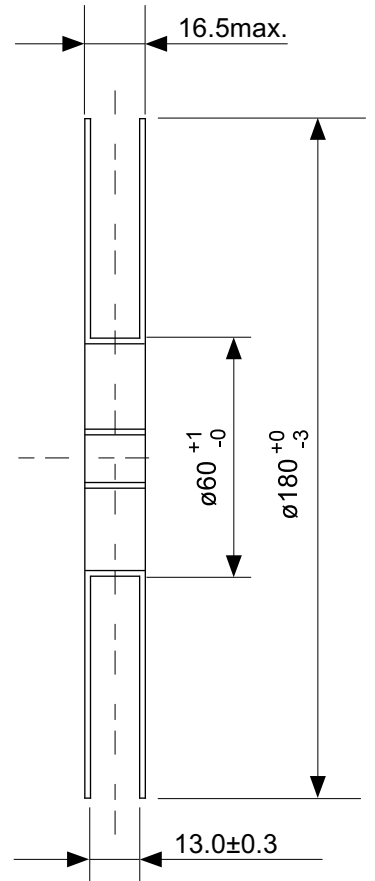
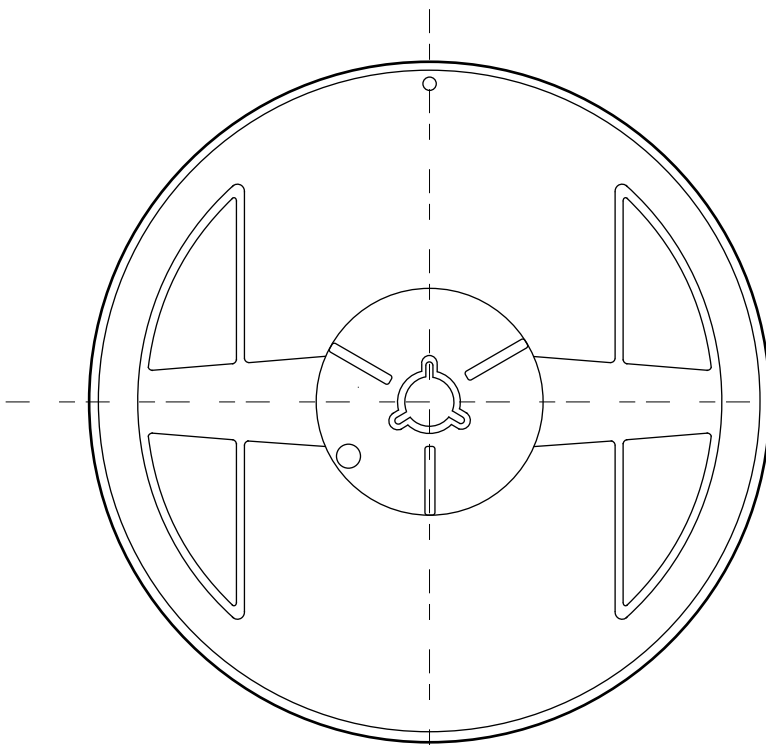

Enlarged drawing in the central part

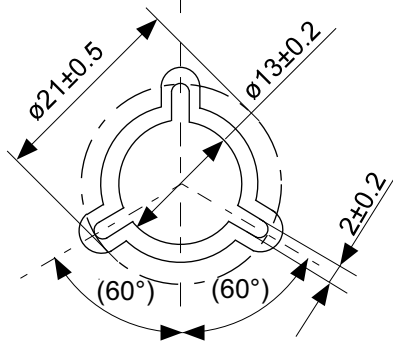

No. FN008-A-R-SD-1.1

TITLE	MSOP8-A-Reel		
No.	FN008-A-R-SD-1.1		
ANGLE		QTY.	3,000
UNIT	mm		
ABLIC Inc.			

Disclaimers (Handling Precautions)

1. All the information described herein (product data, specifications, figures, tables, programs, algorithms and application circuit examples, etc.) is current as of publishing date of this document and is subject to change without notice.
2. The circuit examples and the usages described herein are for reference only, and do not guarantee the success of any specific mass-production design.
ABLIC Inc. is not responsible for damages caused by the reasons other than the products described herein (hereinafter "the products") or infringement of third-party intellectual property right and any other right due to the use of the information described herein.
3. ABLIC Inc. is not responsible for damages caused by the incorrect information described herein.
4. Be careful to use the products within their specified ranges. Pay special attention to the absolute maximum ratings, operation voltage range and electrical characteristics, etc.
ABLIC Inc. is not responsible for damages caused by failures and / or accidents, etc. that occur due to the use of the products outside their specified ranges.
5. When using the products, confirm their applications, and the laws and regulations of the region or country where they are used and verify suitability, safety and other factors for the intended use.
6. When exporting the products, comply with the Foreign Exchange and Foreign Trade Act and all other export-related laws, and follow the required procedures.
7. The products must not be used or provided (exported) for the purposes of the development of weapons of mass destruction or military use. ABLIC Inc. is not responsible for any provision (export) to those whose purpose is to develop, manufacture, use or store nuclear, biological or chemical weapons, missiles, or other military use.
8. The products are not designed to be used as part of any device or equipment that may affect the human body, human life, or assets (such as medical equipment, disaster prevention systems, security systems, combustion control systems, infrastructure control systems, vehicle equipment, traffic systems, in-vehicle equipment, aviation equipment, aerospace equipment, and nuclear-related equipment), excluding when specified for in-vehicle use or other uses. Do not apply the products to the above listed devices and equipments without prior written permission by ABLIC Inc. Especially, the products cannot be used for life support devices, devices implanted in the human body and devices that directly affect human life, etc.
Prior consultation with our sales office is required when considering the above uses.
ABLIC Inc. is not responsible for damages caused by unauthorized or unspecified use of our products.
9. Semiconductor products may fail or malfunction with some probability.
The user of the products should therefore take responsibility to give thorough consideration to safety design including redundancy, fire spread prevention measures, and malfunction prevention to prevent accidents causing injury or death, fires and social damage, etc. that may ensue from the products' failure or malfunction.
The entire system must be sufficiently evaluated and applied on customer's own responsibility.
10. The products are not designed to be radiation-proof. The necessary radiation measures should be taken in the product design by the customer depending on the intended use.
11. The products do not affect human health under normal use. However, they contain chemical substances and heavy metals and should therefore not be put in the mouth. The fracture surfaces of wafers and chips may be sharp. Be careful when handling these with the bare hands to prevent injuries, etc.
12. When disposing of the products, comply with the laws and ordinances of the country or region where they are used.
13. The information described herein contains copyright information and know-how of ABLIC Inc.
The information described herein does not convey any license under any intellectual property rights or any other rights belonging to ABLIC Inc. or a third party. Reproduction or copying of the information from this document or any part of this document described herein for the purpose of disclosing it to a third-party without the express permission of ABLIC Inc. is strictly prohibited.
14. For more details on the information described herein, contact our sales office.

2.2-2018.06

Mouser Electronics

Authorized Distributor

Click to View Pricing, Inventory, Delivery & Lifecycle Information:

ABLIC:

[S-8540B00FN-IMAT2G](#) [S-8540D00FN-IMBT2G](#) [S-8541D00FN-IMET2G](#) [S-8541B00FN-IMDT2G](#) [S-8541C33FN-IIST2G](#) [S-8541A33FN-IGST2G](#) [S-8540A33FN-IAST2G](#) [S-8540C33FN-ICST2G](#) [S-8540A25FN-IAKT2G](#) [S-8540C25FN-ICKT2G](#) [S-8541C25FN-IIKT2G](#) [S-8541A25FN-IGKT2G](#) [S-8540A15FN-IAAT2G](#) [S-8541A16FN-IGBT2G](#) [S-8540A18FN-IADT2G](#) [S-8540C18FN-ICDT2G](#) [S-8541C18FN-IIDT2G](#) [S-8541A18FN-IGDT2G](#) [S-8540A50FN-IBBT2G](#) [S-8541C32FN-IIRT2G](#)

Компания «Life Electronics» занимается поставками электронных компонентов импортного и отечественного производства от производителей и со складов крупных дистрибьюторов Европы, Америки и Азии.

С конца 2013 года компания активно расширяет линейку поставок компонентов по направлению коаксиальный кабель, кварцевые генераторы и конденсаторы (керамические, пленочные, электролитические), за счёт заключения дистрибьюторских договоров

Мы предлагаем:

- Конкурентоспособные цены и скидки постоянным клиентам.
- Специальные условия для постоянных клиентов.
- Подбор аналогов.
- Поставку компонентов в любых объемах, удовлетворяющих вашим потребностям.
- Приемлемые сроки поставки, возможна ускоренная поставка.
- Доставку товара в любую точку России и стран СНГ.
- Комплексную поставку.
- Работу по проектам и поставку образцов.
- Формирование склада под заказчика.
- Сертификаты соответствия на поставляемую продукцию (по желанию клиента).
- Тестирование поставляемой продукции.
- Поставку компонентов, требующих военную и космическую приемку.
- Входной контроль качества.
- Наличие сертификата ISO.

В составе нашей компании организован Конструкторский отдел, призванный помогать разработчикам, и инженерам.

Конструкторский отдел помогает осуществить:

- Регистрацию проекта у производителя компонентов.
- Техническую поддержку проекта.
- Защиту от снятия компонента с производства.
- Оценку стоимости проекта по компонентам.
- Изготовление тестовой платы монтаж и пусконаладочные работы.



Тел: +7 (812) 336 43 04 (многоканальный)
Email: org@lifeelectronics.ru