

FEATURES

Meets EIA RS-485 Standard
30 Mbps Data Rate
Single 5 V Supply
-7 V to +12 V Bus Common-Mode Range
High Speed, Low Power BiCMOS
Thermal Shutdown Protection
Short-Circuit Protection
Driver Propagation Delay: 10 ns
Receiver Propagation Delay: 15 ns
High-Z Outputs with Power Off
Superior Upgrade for LTC1485

APPLICATIONS

Low Power RS-485 Systems
DTE-DCE Interface
Packet Switching
Local Area Networks
Data Concentration
Data Multiplexers
Integrated Services Digital Network (ISDN)

GENERAL DESCRIPTION

The ADM1485 is a differential line transceiver suitable for high speed bidirectional data communication on multipoint bus transmission lines. It is designed for balanced data transmission and complies with both RS-485 and RS-422 EIA Standards. The part contains a differential line driver and a differential line receiver. Both the driver and the receiver may be enabled independently. When disabled, the outputs are three-stated.

The ADM1485 operates from a single 5 V power supply. Excessive power dissipation caused by bus contention or by output shorting is prevented by a thermal shutdown circuit. This feature forces the driver output into a high impedance state if, during fault conditions, a significant temperature increase is detected in the internal driver circuitry.

Up to 32 transceivers may be connected simultaneously on a bus, but only one driver should be enabled at any time. It is important, therefore, that the remaining disabled drivers do not load the bus. To ensure this, the ADM1485 driver features high output impedance when disabled and also when powered down.

FUNCTIONAL BLOCK DIAGRAM

8-Lead



This minimizes the loading effect when the transceiver is not being used. The high impedance driver output is maintained over the entire common-mode voltage range from -7 V to +12 V.

The receiver contains a fail-safe feature that results in a logic high output state if the inputs are unconnected (floating).

The ADM1485 is fabricated on BiCMOS, an advanced mixed technology process combining low power CMOS with fast switching bipolar technology. All inputs and outputs contain protection against ESD; all driver outputs feature high source and sink current capability. An epitaxial layer is used to guard against latch-up.

The ADM1485 features extremely fast switching speeds. Minimal driver propagation delays permit transmission at typical data rates of 30 Mbps while low skew minimizes EMI interference.

The part is fully specified over the commercial and industrial temperature range and is available in PDIP, SOIC, and small MSOP packages.

REV. F

Information furnished by Analog Devices is believed to be accurate and reliable. However, no responsibility is assumed by Analog Devices for its use, nor for any infringements of patents or other rights of third parties that may result from its use. No license is granted by implication or otherwise under any patent or patent rights of Analog Devices. Trademarks and registered trademarks are the property of their respective owners.

ADM1485—SPECIFICATIONS ($V_{CC} = 5\text{ V} \pm 5\%$. All specifications T_{MIN} to T_{MAX} , unless otherwise noted.)

Parameter	Min	Typ	Max	Unit	Test Conditions/Comments
DRIVER					
Differential Output Voltage, V_{OD}			5.0	V	$R = \infty$, Test Circuit 1
	2.0		5.0	V	$V_{CC} = 5\text{ V}$, $R = 50\ \Omega$ (RS-422), Test Circuit 1
	1.5		5.0	V	$R = 27\ \Omega$ (RS-485), Test Circuit 1
V_{OD3}	1.5		5.0	V	$V_{TST} = -7\text{ V}$ to $+12\text{ V}$, Test Circuit 2
$\Delta V_{OD} $ for Complementary Output States			0.2	V	$R = 27\ \Omega$ or $50\ \Omega$, Test Circuit 1
Common-Mode Output Voltage V_{OC}			3	V	$R = 27\ \Omega$ or $50\ \Omega$, Test Circuit 1
$\Delta V_{OD} $ for Complementary Output States			0.2	V	$R = 27\ \Omega$ or $50\ \Omega$
Output Short-Circuit Current ($V_{OUT} = \text{High}$)	35		250	mA	$-7\text{ V} \leq V_O \leq +12\text{ V}$
Output Short-Circuit Current ($V_{OUT} = \text{Low}$)	35		250	mA	$-7\text{ V} \leq V_O \leq +12\text{ V}$
CMOS Input Logic Threshold Low, V_{INL}			0.8	V	
CMOS Input Logic Threshold High, V_{INH}	2.0			V	
Logic Input Current (DE, DI)			± 1.0	μA	
RECEIVER					
Differential Input Threshold Voltage, V_{TH}	-0.2		+0.2	V	$-7\text{ V} \leq V_{CM} \leq +12\text{ V}$
Input Voltage Hysteresis, ΔV_{TH}		70		mV	$V_{CM} = 0\text{ V}$
Input Resistance	12			k Ω	$-7\text{ V} \leq V_{CM} \leq +12\text{ V}$
Input Current (A, B)			1	mA	$V_{IN} = +12\text{ V}$
			-0.8	mA	$V_{IN} = -7\text{ V}$
CMOS Input Logic Threshold Low, V_{INL}			0.8	V	
CMOS Input Logic Threshold High, V_{INH}	2.0			V	
Logic Enable Input Current (\overline{RE})			± 1	μA	
CMOS Output Voltage Low, V_{OL}			0.4	V	$I_{OUT} = +4.0\text{ mA}$
CMOS Output Voltage High, V_{OH}	4.0			V	$I_{OUT} = -4.0\text{ mA}$
Short-Circuit Output Current	7		85	mA	$V_{OUT} = \text{GND}$ or V_{CC}
Three-State Output Leakage Current			± 1.0	μA	$0.4\text{ V} \leq V_{OUT} \leq 2.4\text{ V}$
POWER SUPPLY CURRENT					
I_{CC} (Outputs Enabled)		1.0	2.2	mA	Digital Inputs = GND or V_{CC}
I_{CC} (Outputs Disabled)		0.6	1	mA	Digital Inputs = GND or V_{CC}

Specifications subject to change without notice.

TIMING SPECIFICATIONS ($V_{CC} = 5\text{ V} \pm 5\%$. All specifications T_{MIN} to T_{MAX} , unless otherwise noted.)

Parameter	Min	Typ	Max	Unit	Test Conditions/Comments
DRIVER					
Propagation Delay Input to Output t_{PLH} , t_{PHL}	2	10	15	ns	$R_{LDIFF} = 54\ \Omega$, $C_{L1} = C_{L2} = 100\text{ pF}$, Test Circuit 3
Driver O/P to \overline{OP} t_{SKEW}		1	5	ns	$R_{LDIFF} = 54\ \Omega$, $C_{L1} = C_{L2} = 100\text{ pF}$, Test Circuit 3
Driver Rise/Fall Time t_R , t_F		8	15	ns	$R_{LDIFF} = 54\ \Omega$, $C_{L1} = C_{L2} = 100\text{ pF}$, Test Circuit 3
Driver Enable to Output Valid		10	25	ns	$R_L = 110\ \Omega$, $C_L = 50\text{ pF}$, Test Circuit 4
Driver Disable Timing		10	25	ns	$R_L = 110\ \Omega$, $C_L = 50\text{ pF}$, Test Circuit 4
Matched Enable Switching		0	2	ns	$R_L = 110\ \Omega$, $C_L = 50\text{ pF}$, Test Circuit 4*
$ t_{AZH} - t_{BZL} $, $ t_{BZH} - t_{AZL} $					
Matched Disable Switching		0	2	ns	$R_L = 110\ \Omega$, $C_L = 50\text{ pF}$, Test Circuit 4*
$ t_{AHZ} - t_{BLZ} $, $ t_{BHZ} - t_{ALZ} $					
RECEIVER					
Propagation Delay Input to Output t_{PLH} , t_{PHL}	8	15	30	ns	$C_L = 15\text{ pF}$, Test Circuit 5
Skew $ t_{PLH} - t_{PHL} $			5	ns	$C_L = 15\text{ pF}$, Test Circuit 5
Receiver Enable t_{EN1}		5	20	ns	$C_L = 15\text{ pF}$, $R_L = 1\text{ k}\Omega$, Test Circuit 6
Receiver Disable t_{EN2}		5	20	ns	$C_L = 15\text{ pF}$, $R_L = 1\text{ k}\Omega$, Test Circuit 6
Tx Pulse Width Distortion		1		ns	
Rx Pulse Width Distortion		1		ns	

*Guaranteed by characterization.

Specifications subject to change without notice.

ABSOLUTE MAXIMUM RATINGS*

(T_A = 25°C, unless otherwise noted.)

V _{CC}	-0.3 V to +7 V
Inputs	
Driver Input (DI)	-0.3 V to V _{CC} + 0.3 V
Control Inputs (DE, \overline{RE})	-0.3 V to V _{CC} + 0.3 V
Receiver Inputs (A, B)	-9 V to +14 V
Outputs	
Driver Outputs (A, B)	-9 V to +14 V
Receiver Output	-0.5 V to V _{CC} + 0.5 V
Power Dissipation 8-Lead MSOP	900 mW
θ _{JA} , Thermal Impedance	206°C/W
Power Dissipation 8-Lead PDIP	500 mW
θ _{JA} , Thermal Impedance	130°C/W
Power Dissipation 8-Lead SOIC	450 mW
θ _{JA} , Thermal Impedance	170°C/W
Operating Temperature Range	
Commercial (J Version)	0°C to 70°C
Industrial (A Version)	-40°C to +85°C
Storage Temperature Range	-65°C to +150°C
Lead Temperature (Soldering, 10 sec)	300°C
Vapor Phase (60 sec)	215°C
Infrared (15 sec)	220°C

*Stresses above those listed under Absolute Maximum Ratings may cause permanent damage to the device. This is a stress rating only; functional operation of the device at these or any other conditions above those listed in the operational sections of this specification is not implied. Exposure to absolute maximum ratings for extended periods of time may affect device reliability.

Table I. Transmitting

Inputs		Outputs	
DE	DI	B	A
1	1	0	1
1	0	1	0
0	X	Z	Z

Table II. Receiving

\overline{RE}	Inputs A-B	Outputs RO
0	≥ +0.2 V	1
0	≤ -0.2 V	0
0	Inputs Open	1
1	X	Z

PIN FUNCTION DESCRIPTIONS

Pin No.	Mnemonic	Function
1	RO	Receiver Output. When enabled if A > B by 200 mV, then RO = High. If A < B by 200 mV, then RO = Low.
2	\overline{RE}	Receiver Output Enable. A low level enables the receiver output, RO. A high level places it in a high impedance state.
3	DE	Driver Output Enable. A high level enables the driver differential outputs, A and B. A low level places it in a high impedance state.
4	DI	Driver Input. When the driver is enabled, a logic low on DI forces A low and B high while a logic high on DI forces A high and B low.
5	GND	Ground Connection, 0 V.
6	A	Noninverting Receiver Input A/Driver Output A.
7	B	Inverting Receiver Input B/Driver Output B
8	V _{CC}	Power Supply, 5 V ± 5%.

PIN CONFIGURATION



CAUTION

ESD (electrostatic discharge) sensitive device. Electrostatic charges as high as 4000 V readily accumulate on the human body and test equipment and can discharge without detection. Although the ADM1485 features proprietary ESD protection circuitry, permanent damage may occur on devices subjected to high energy electrostatic discharges. Therefore, proper ESD precautions are recommended to avoid performance degradation or loss of functionality.



ADM1485

Test Circuits



Test Circuit 1. Driver Voltage Measurement



Test Circuit 4. Driver Enable/Disable



Test Circuit 2. Driver Voltage Measurement



Test Circuit 5. Receiver Propagation Delay



Test Circuit 3. Driver Propagation Delay



Test Circuit 6. Receiver Enable/Disable

Switching Characteristics



Figure 1. Driver Propagation Delay, Rise/Fall Timing



Figure 3. Receiver Propagation Delay

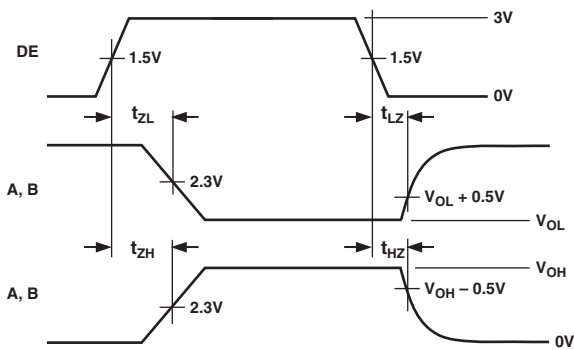

Figure 2. Driver Enable/Disable Timing

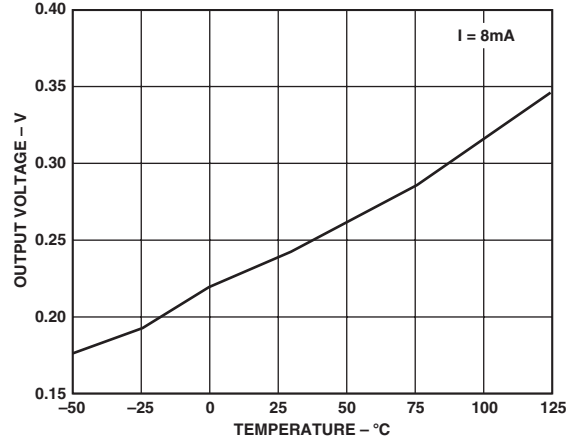

Figure 4. Receiver Enable/Disable Timing

Typical Performance Characteristics—ADM1485



TPC 1. Output Current vs. Receiver Output Low Voltage



TPC 4. Receiver Output Low Voltage vs. Temperature



TPC 2. Output Current vs. Receiver Output High Voltage



TPC 5. Output Current vs. Driver Differential Output Voltage

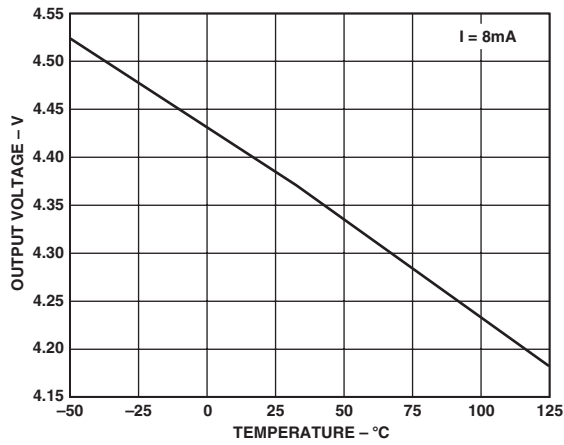

TPC 3. Receiver Output High Voltage vs. Temperature

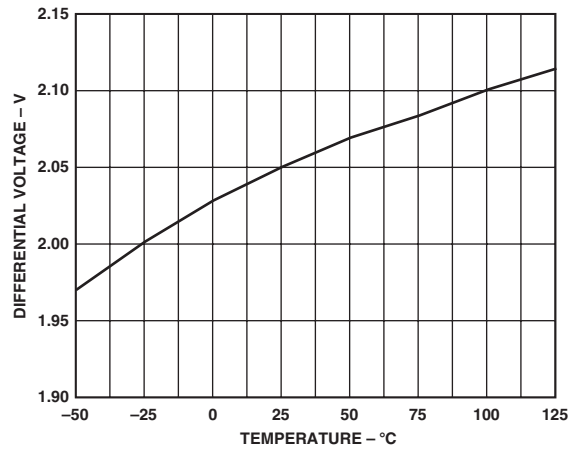

TPC 6. Driver Differential Output Voltage vs. Temperature, $R_L = 26.8 \Omega$

ADM1485



TPC 7. Output Current vs. Driver Output Low Voltage



TPC 10. Rx Skew vs. Temperature



TPC 8. Output Current vs. Driver Output High Voltage



TPC 11. Tx Skew vs. Temperature



TPC 9. Supply Current vs. Temperature



TPC 12. Tx Pulse Width Distortion



TPC 13. Unloaded Driver Differential Outputs



TPC 16. Driver/Receiver Propagation Delays High to Low

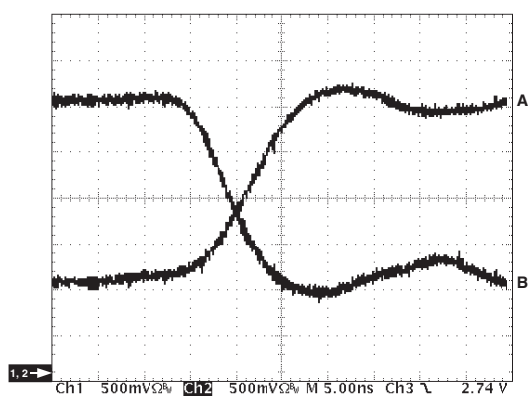

TPC 14. Loaded Driver Differential Outputs

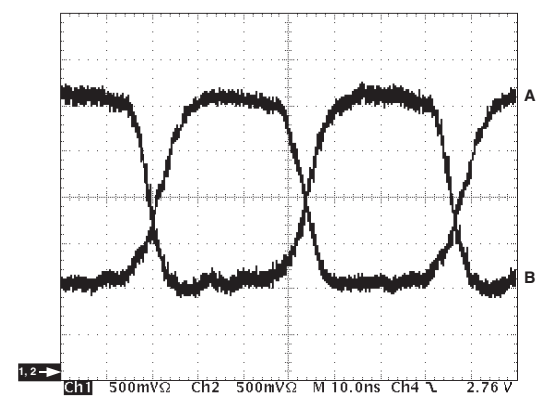

TPC 17. Driver Output at 30 Mbps

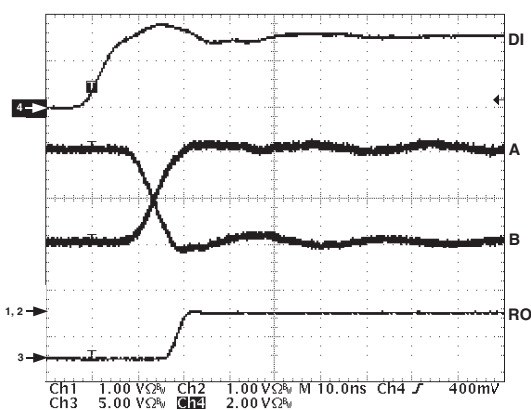

TPC 15. Driver/Receiver Propagation Delays Low to High

ADM1485

APPLICATION INFORMATION

Differential Data Transmission

Differential data transmission is used to reliably transmit data at high rates over long distances and through noisy environments. Differential transmission nullifies the effects of ground shifts and noise signals that appear as common-mode voltages on the line. There are two main standards approved by the Electronics Industries Association (EIA) that specify the electrical characteristics of transceivers used in differential data transmission.

The RS-422 standard specifies data rates up to 10 MBaud and line lengths up to 4000 ft. A single driver can drive a transmission line with up to 10 receivers.

In order to cater to true multipoint communications, the RS-485 standard was defined. This standard meets or exceeds all the requirements of the RS-422 but also allows for up to 32 drivers and 32 receivers to be connected to a single bus. An extended common-mode range of -7 V to $+12\text{ V}$ is defined. The most significant difference between the RS-422 and the RS-485 is the fact that the drivers may be disabled, thereby allowing more than one (32 in fact) to be connected to a single line. Only one driver should be enabled at a time, but the RS-485 standard contains additional specifications to guarantee device safety in the event of line contention.

Table III. Comparison of RS-422 and RS-485 Interface Standards

Specification	RS-422	RS-485
Transmission Type	Differential	Differential
Maximum Cable Length	4000 ft.	4000 ft.
Minimum Driver Output Voltage	$\pm 2\text{ V}$	$\pm 1.5\text{ V}$
Driver Load Impedance	100 Ω	54 Ω
Receiver Input Resistance	4 k Ω min	12 k Ω min
Receiver Input Sensitivity	$\pm 200\text{ mV}$	$\pm 200\text{ mV}$
Receiver Input Voltage Range	-7 V to $+7\text{ V}$	-7 V to $+12\text{ V}$
No. of Drivers/Receivers per Line	1/10	32/32

Cable and Data Rate

The transmission line of choice for RS-485 communications is a twisted pair. Twisted pair cable tends to cancel common-mode noise and also causes cancellation of the magnetic fields generated by the current flowing through each wire, thereby reducing the effective inductance of the pair.

The ADM1485 is designed for bidirectional data communications on multipoint transmission lines. A typical application showing a multipoint transmission network is illustrated in Figure 5. An RS-485 transmission line can have as many as 32 transceivers on the bus. Only one driver can transmit at a particular time, but multiple receivers may be enabled simultaneously.

As with any transmission line, it is important that reflections are minimized. This can be achieved by terminating the extreme ends of the line using resistors equal to the characteristic impedance of the line. Stub lengths of the main line should also be kept as short as possible. A properly terminated transmission line appears purely resistive to the driver.

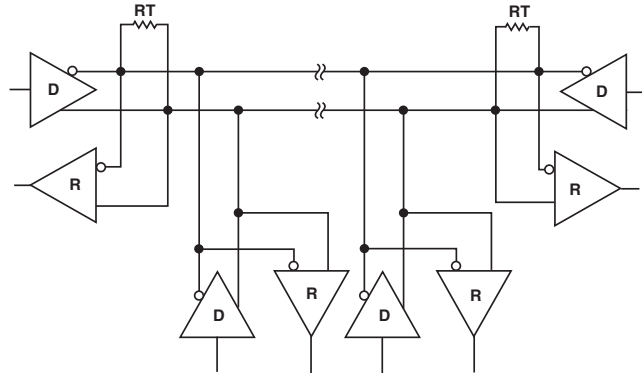

Figure 5. Typical RS-485 Network

Thermal Shutdown

The ADM1485 contains thermal shutdown circuitry that protects the part from excessive power dissipation during fault conditions. Shorting the driver outputs to a low impedance source can result in high driver currents. The thermal sensing circuitry detects the increase in die temperature and disables the driver outputs. The thermal sensing circuitry is designed to disable the driver outputs when a die temperature of 150°C is reached. As the device cools, the drivers are re-enabled at 140°C .

Propagation Delay

The ADM1485 features very low propagation delay, ensuring maximum baud rate operation. The driver is well balanced, ensuring distortion free transmission.

Another important specification is a measure of the skew between the complementary outputs. Excessive skew impairs the noise immunity of the system and increases the amount of electromagnetic interference (EMI).

Receiver Open-Circuit Fail-Safe

The receiver input includes a fail-safe feature that guarantees a logic high on the receiver when the inputs are open circuit or floating.

OUTLINE DIMENSIONS



COMPLIANT TO JEDEC STANDARDS MS-012-AA
 CONTROLLING DIMENSIONS ARE IN MILLIMETERS; INCH DIMENSIONS (IN PARENTHESES) ARE ROUNDED-OFF MILLIMETER EQUIVALENTS FOR REFERENCE ONLY AND ARE NOT APPROPRIATE FOR USE IN DESIGN.

Figure 6. 8-Lead Standard Small Outline Package [SOIC_N] Narrow Body (R-8)

Dimensions shown in millimeters and (inches)

012407-A



COMPLIANT TO JEDEC STANDARDS MO-187-AA

Figure 7. 8-Lead Mini Small Outline Package [MSOP] (RM-8)

Dimensions shown in millimeters

10-07-2009-B

ADM1485



COMPLIANT TO JEDEC STANDARDS MS-001
 CONTROLLING DIMENSIONS ARE IN INCHES; MILLIMETER DIMENSIONS
 (IN PARENTHESES) ARE ROUNDED-OFF INCH EQUIVALENTS FOR
 REFERENCE ONLY AND ARE NOT APPROPRIATE FOR USE IN DESIGN.
 CORNER LEADS MAY BE CONFIGURED AS WHOLE OR HALF LEADS.

070606-A

Figure 8. 8-Lead Plastic Dual In-Line Package [PDIP]
 Narrow Body
 (N-8)

Dimensions shown in inches and (millimeters)

ORDERING GUIDE

Model ¹	Temperature Range	Package Description	Package Option	Brand
ADM1485JNZ	0°C to 70°C	8-Lead PDIP	N-8	
ADM1485JRZ	0°C to 70°C	8-Lead SOIC_N	R-8	
ADM1485JR-REEL	0°C to 70°C	8-Lead SOIC_N	R-8	
ADM1485JRZ-REEL	0°C to 70°C	8-Lead SOIC_N	R-8	
ADM1485ANZ	-40°C to +85°C	8-Lead PDIP	N-8	
ADM1485ARMZ	-40°C to +85°C	8-Lead MSOP	RM-8	M42
ADM1485ARMZ-REEL	-40°C to +85°C	8-Lead MSOP	RM-8	M42
ADM1485ARMZ-REEL7	-40°C to +85°C	8-Lead MSOP	RM-8	M42
ADM1485ARZ		8-Lead SOIC_N	R-8	
ADM1485ARZ-REEL		8-Lead SOIC_N	R-8	
ADM1485ARZ-REEL7		8-Lead SOIC_N	R-8	
ADM1485JCHIPS		Die		

¹ Z = RoHS Compliant Part.

REVISION HISTORY**8/12—Rev. E to Rev. F**

Changed Data Rates of Up to 5 Mbps to Typical Data Rates of 30 Mbps.....	1
Updated Outline Dimensions	9
Changes to Ordering Guide	10

9/03—Data Sheet changed from REV. D to REV. E.

Change to SPECIFICATIONS.....	2
Changes to ORDERING GUIDE	3
Updated OUTLINE DIMENSIONS	9

7/03—Data Sheet changed from REV. C to REV. D.

Changes to SPECIFICATIONS	2
Changes to ABSOLUTE MAXIMUM RATINGS.....	3
Updated ORDERING GUIDE.....	3

1/03—Data Sheet changed from REV. B to REV. C.

Change to SPECIFICATIONS.....	2
Change to ORDERING GUIDE.....	3

12/02—Data Sheet changed from REV. A to REV. B.

Deleted Q-8 Package.....	Universal
Edits to FEATURES	1
Edits to GENERAL DESCRIPTION	1
Edits, additions to SPECIFICATIONS	2
Edits, additions to ABSOLUTE MAXIMUM RATINGS.....	3
Additions to ORDERING GUIDE.....	3
TPCs updated and reformatted	5
Addition of 8-Lead MSOP Package	9
Update to OUTLINE DIMENSIONS	9

Компания «Life Electronics» занимается поставками электронных компонентов импортного и отечественного производства от производителей и со складов крупных дистрибьюторов Европы, Америки и Азии.

С конца 2013 года компания активно расширяет линейку поставок компонентов по направлению коаксиальный кабель, кварцевые генераторы и конденсаторы (керамические, пленочные, электролитические), за счёт заключения дистрибьюторских договоров

Мы предлагаем:

- Конкурентоспособные цены и скидки постоянным клиентам.
- Специальные условия для постоянных клиентов.
- Подбор аналогов.
- Поставку компонентов в любых объемах, удовлетворяющих вашим потребностям.
- Приемлемые сроки поставки, возможна ускоренная поставка.
- Доставку товара в любую точку России и стран СНГ.
- Комплексную поставку.
- Работу по проектам и поставку образцов.
- Формирование склада под заказчика.
- Сертификаты соответствия на поставляемую продукцию (по желанию клиента).
- Тестирование поставляемой продукции.
- Поставку компонентов, требующих военную и космическую приемку.
- Входной контроль качества.
- Наличие сертификата ISO.

В составе нашей компании организован Конструкторский отдел, призванный помогать разработчикам, и инженерам.

Конструкторский отдел помогает осуществить:

- Регистрацию проекта у производителя компонентов.
- Техническую поддержку проекта.
- Защиту от снятия компонента с производства.
- Оценку стоимости проекта по компонентам.
- Изготовление тестовой платы монтаж и пусконаладочные работы.



Тел: +7 (812) 336 43 04 (многоканальный)

Email: org@lifeelectronics.ru