



Typical Applications

The HMC705LP4(E) is ideal for:

- Satellite Communication Systems
- Point-to-Point Radios
- Military Applications
- Sonet Clock Generation
- Test Equipment

Features

- Ultra Low SSB Phase Noise Floor:
-153 dBc/Hz @ 100 kHz
- Programmable Divider (N= 1 - 17) Operating up to 6.5 GHz
- 24 Lead 4X4mm SMT Package: 16mm²

Functional Diagram

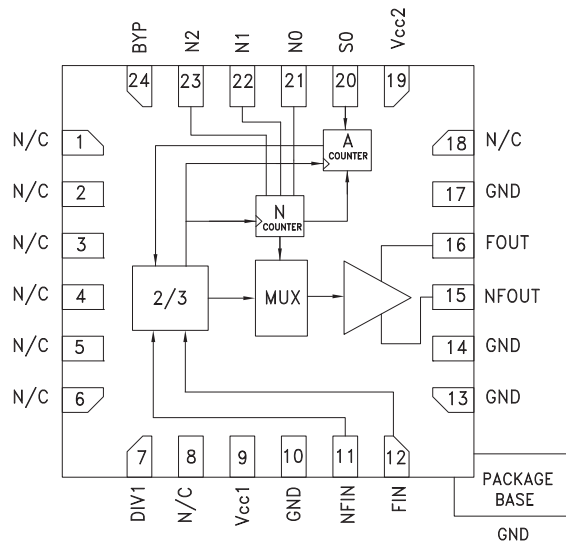

General Description

The HMC705LP4(E) is a low noise GaAs HBT programmable divider in a 4x4 mm leadless surface mount package. The divider can be programmed to divide by any number from N = 1 to N = 17 up to 6.5 GHz. The HMC705LP4E's high frequency operation along with low phase noise floor is very useful in high performance fast settling synthesizer architectures. The HMC705LP4E may be combined with Hittite's Phase Frequency Detectors, VCOs and PLL ICs to create low noise, fast settling phase locked loops.

Electrical Specifications, $T_A = +25^\circ C$, $V_{cc} = V_{cc1} = V_{cc2} = +5V$

Parameter	Conditions	Min.	Typ.	Max.	Units
Maximum Input Frequency	Sine Wave or Square Wave Input	6.5			GHz
Minimum Input Frequency	Sine Wave or Square Wave Input			0.1	GHz
Input Power Range	$F_{in} = 0.1$ to 6.5 GHz*	-15	0	10	dBm
Output Power	Divide-by-2		0		dBm
SSB Phase Noise	$F_{in} = 6$ GHz, N = 17		-153		dBc/Hz
Total Supply Current			190		mA

* For sine wave inputs less than 400 MHz input power must be greater than or equal to -5 dBm



Input Sensitivity Window, All States

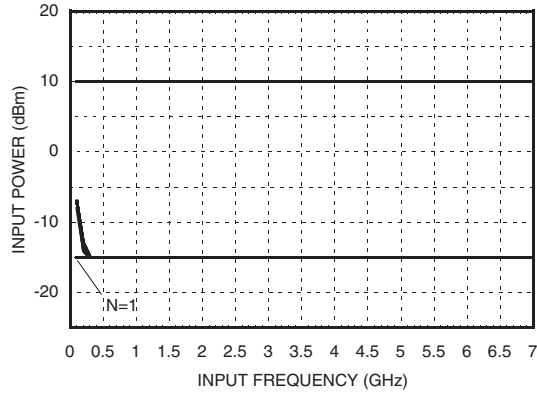

Input Sensitivity Window vs. Temperature, N = 17, T = -40°C to +85°C

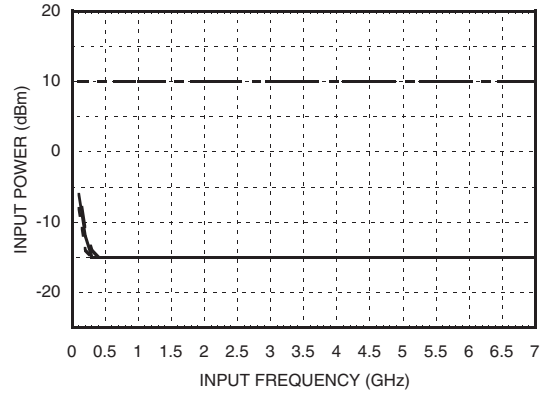

Output Power, Divide Ratio States 1 through 5

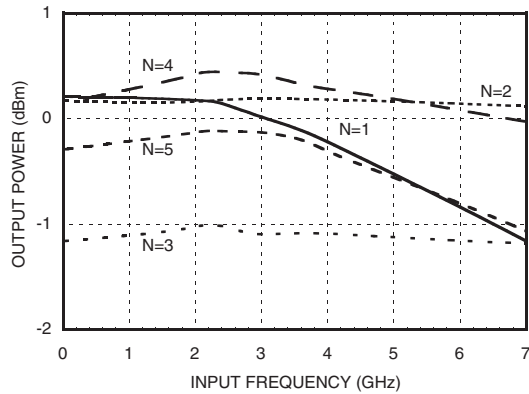

Output Power, Divide Ratio States 6 through 17

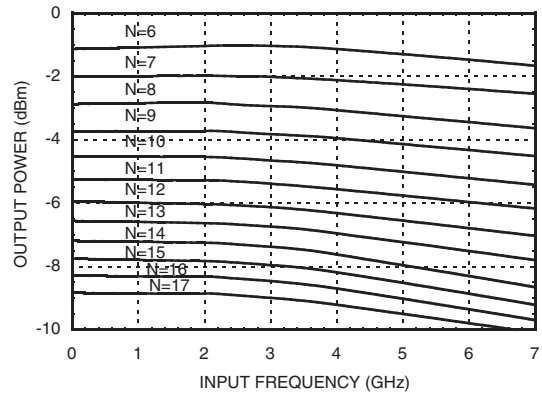

Fundamental Feedthru Power, Pin = 0 dBm

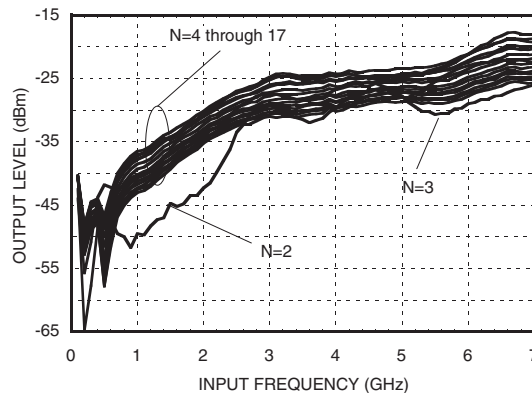

Information furnished by Analog Devices is believed to be accurate and reliable. However, no responsibility is assumed by Analog Devices for its use, nor for any infringements of patents or other rights of third parties that may result from its use. Specifications subject to change without notice. No license is granted by implication or otherwise under any patent or patent rights of Analog Devices. Trademarks and registered trademarks are the property of their respective owners.

For price, delivery, and to place orders: Analog Devices, Inc., One Technology Way, P.O. Box 9106, Norwood, MA 02062-9106 Phone: 781-329-4700 • Order online at www.analog.com Application Support: Phone: 1-800-ANALOG-D

6.5 GHz PROGRAMMABLE DIVIDER (N = 1 - 17)



SSB Phase Noise Performance

Fin = 6 GHz, N = 2; T = -40°C, +25°C, +85°C

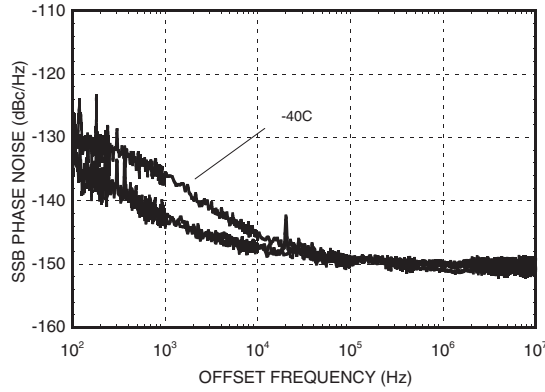

SSB Phase Noise Performance

Fin = 6 GHz, N = 17; T = -40°C, +25°C, +85°C

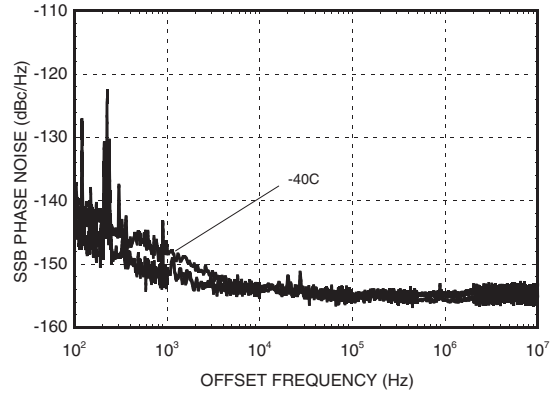

SSB Phase Noise Performance

Fin = 6 GHz, N = 2; Vcc = 4.75V, 5V, 5.25V

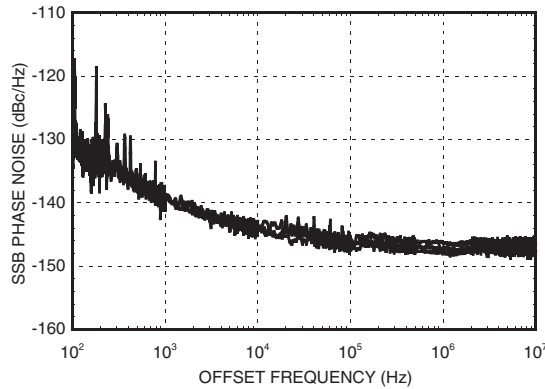

SSB Phase Noise Performance

Fin = 6 GHz, N = 17; Vcc = 4.75V, 5V, 5.25V

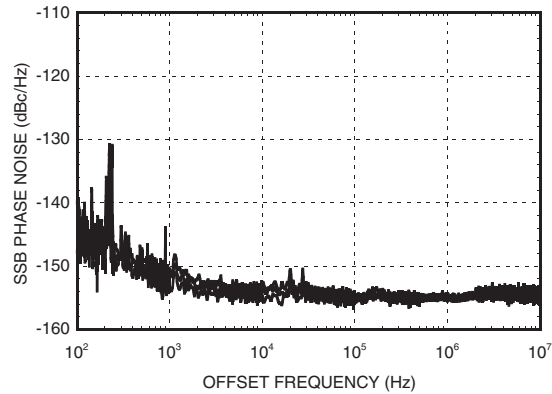

2nd Harmonic, N = 1 through 5

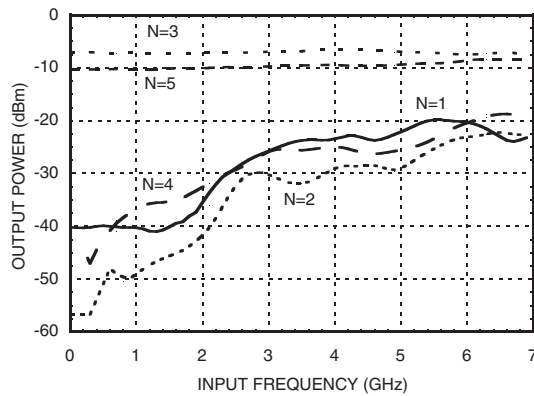

2nd Harmonic, N = 6 through 17

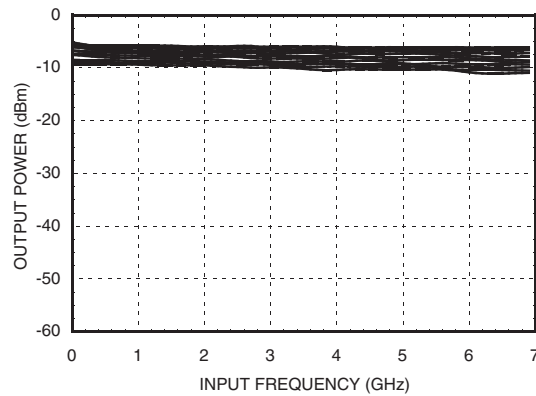

Information furnished by Analog Devices is believed to be accurate and reliable. However, no responsibility is assumed by Analog Devices for its use, nor for any infringements of patents or other rights of third parties that may result from its use. Specifications subject to change without notice. No license is granted by implication or otherwise under any patent or patent rights of Analog Devices. Trademarks and registered trademarks are the property of their respective owners.

For price, delivery, and to place orders: Analog Devices, Inc., One Technology Way, P.O. Box 9106, Norwood, MA 02062-9106 Phone: 781-329-4700 • Order online at www.analog.com Application Support: Phone: 1-800-ANALOG-D



3rd Harmonic, N = 1 through 5

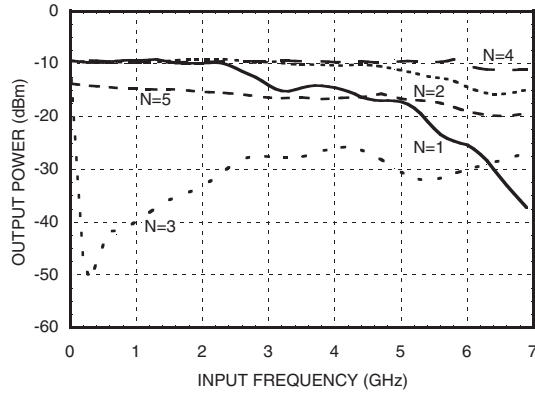

3rd Harmonic, N = 6 through 17

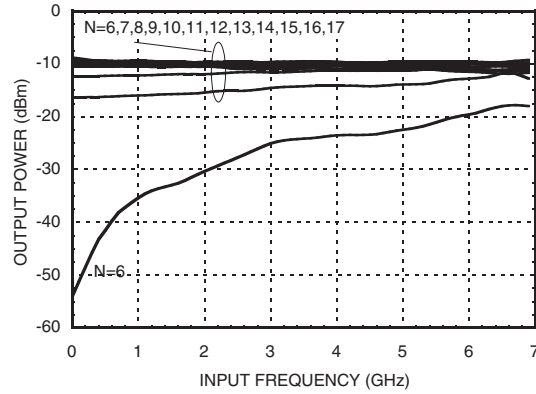

4th Harmonic, N = 1 through 5

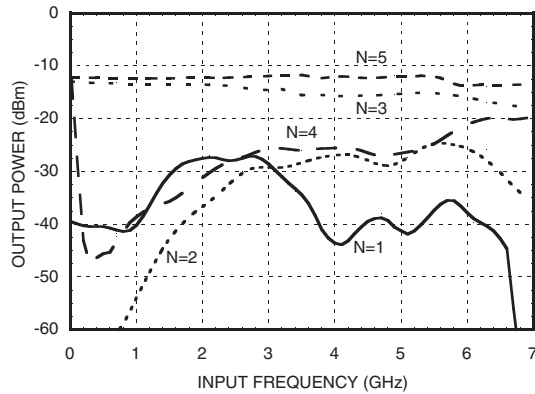

4th Harmonic, N = 6 through 17

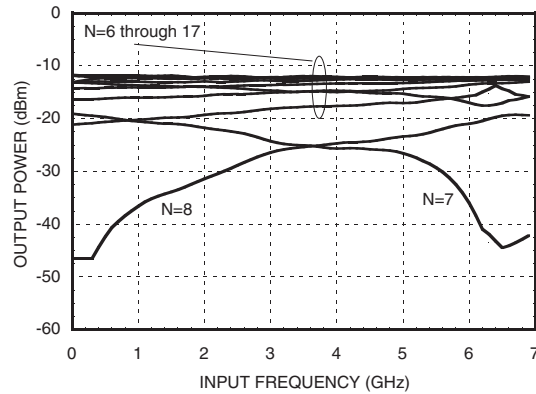

5th Harmonic, N = 1 through 5

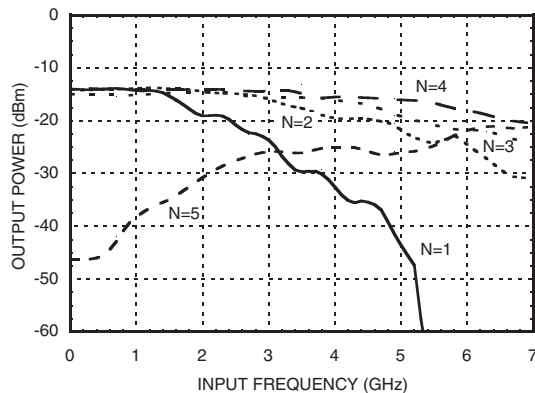

5th Harmonic, N = 6 through 17

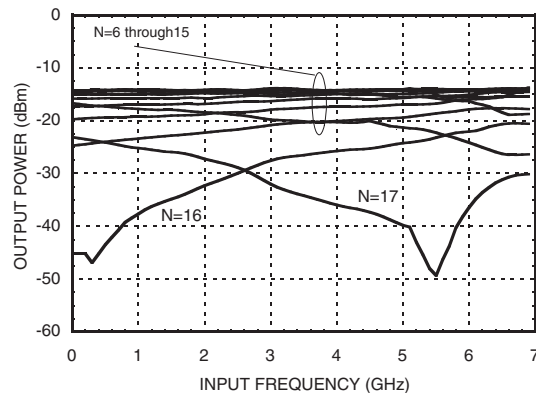

Information furnished by Analog Devices is believed to be accurate and reliable. However, no responsibility is assumed by Analog Devices for its use, nor for any infringements of patents or other rights of third parties that may result from its use. Specifications subject to change without notice. No license is granted by implication or otherwise under any patent or patent rights of Analog Devices. Trademarks and registered trademarks are the property of their respective owners.

For price, delivery, and to place orders: Analog Devices, Inc., One Technology Way, P.O. Box 9106, Norwood, MA 02062-9106 Phone: 781-329-4700 • Order online at www.analog.com Application Support: Phone: 1-800-ANALOG-D

6.5 GHz PROGRAMMABLE DIVIDER (N = 1 - 17)

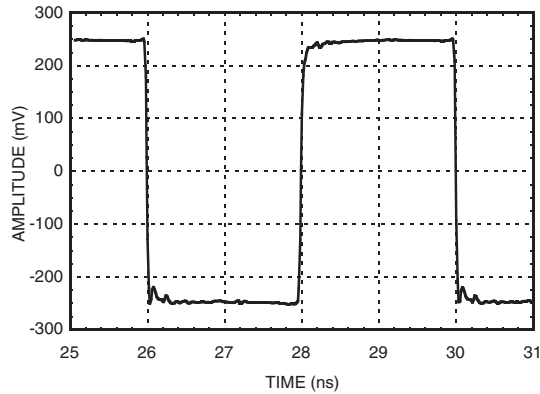
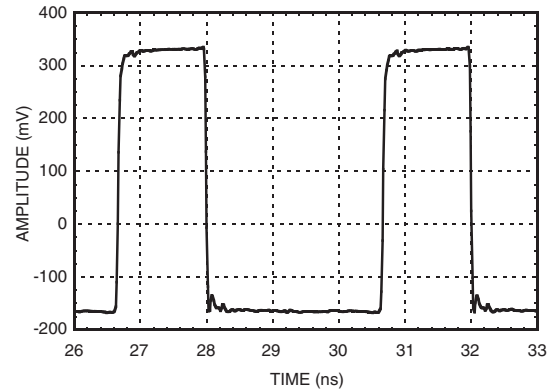
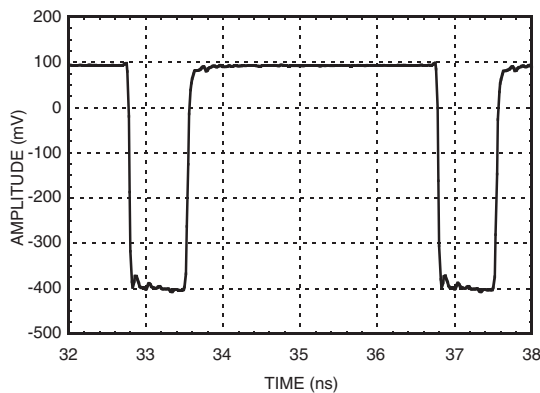
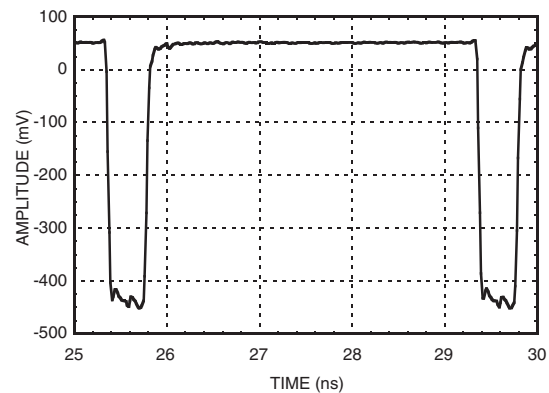
**Output Voltage Waveform, $F_{in} = 500$ MHz,
 $N = 2$, $P_{in} = 0$ dBm, $T = 25$ °C**

**Output Voltage Waveform, $F_{in} = 750$ MHz,
 $N = 3$, $P_{in} = 0$ dBm, $T = 25$ °C**

**Output Voltage Waveform, $F_{in} = 2500$ MHz,
 $N = 10$, $P_{in} = 0$ dBm, $T = 25$ °C**

**Output Voltage Waveform, $F_{in} = 4250$ MHz,
 $N = 17$, $P_{in} = 0$ dBm, $T = 25$ °C**

N	Output Duty Cycle (%)
1	Input
2	50
3 - 17	$[1 - (2/N)] \times 100$

Note:

- [1] Peak to peak amplitude does not change relative to N.
- [2] Pulse duty cycle changes relative to N.



Absolute Maximum Ratings

RF Input (Vcc= +5V)	+13 dBm
Supply Voltage (Vcc)	+5.5V
Logic Inputs	-0.5V to (0.5V + Vcc)
Junction Temperature (Tc)	135 °C
Continuous Pdiss (T = 85 °C) (derate 49 mW/° C above 85 °C)	2.4 W
Thermal Resistance (Junction to ground paddle)	20.5 °C/W
Storage Temperature	-65 to +150 °C
Operating Temperature	-40 to +85 °C

Typical Supply Current vs. Vcc

Vcc (V)	Icc (mA)
4.75	180
5.00	190
5.25	210

Note: HMC705LP4E will work over full voltage range above.



**ELECTROSTATIC SENSITIVE DEVICE
OBSERVE HANDLING PRECAUTIONS**

Outline Drawing

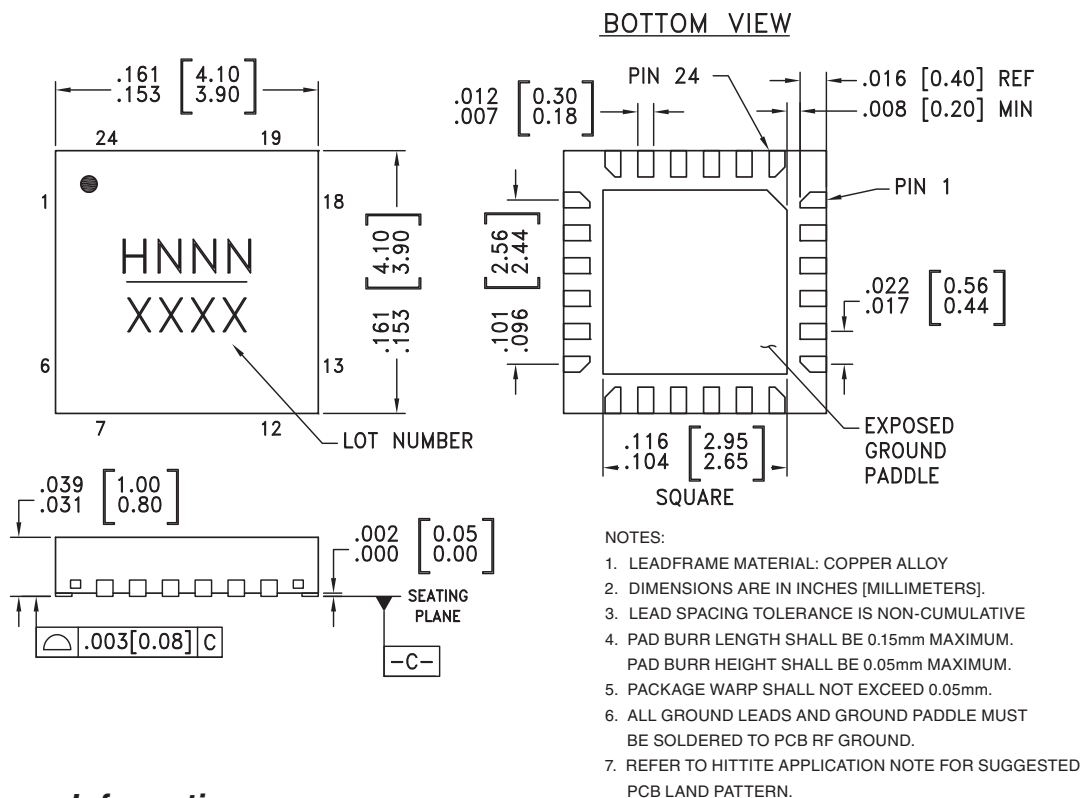

Package Information

Part Number	Package Body Material	Lead Finish	MSL Rating	Package Marking ^[3]
HMC705LP4	Low Stress Injection Molded Plastic	Sn/Pb Solder	MSL1 ^[1]	H705 XXXX
HMC705LP4E	RoHS-compliant Low Stress Injection Molded Plastic	100% matte Sn	MSL1 ^[2]	H705 XXXX

[1] Max peak reflow temperature of 235 °C

[2] Max peak reflow temperature of 260 °C

[3] 4-Digit lot number XXXX

Pin Description

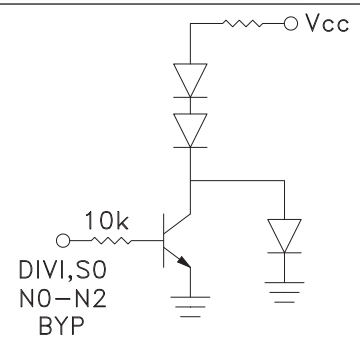
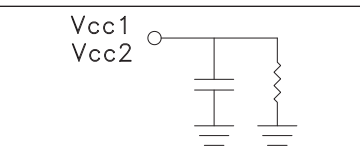
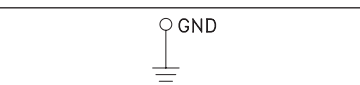
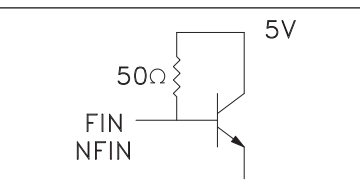
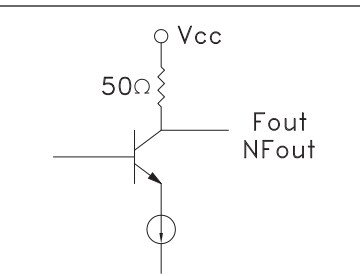
Pin Number	Function	Description	Interface Schematic
1 - 6, 8, 18	N/C	The pins are not connected internally; however, all data shown herein was measured with these pins connected to RF/DC ground externally.	
7, 20 - 24	DIV1, S0 N0 - N2 BYP	PFD INVERT function CMOS compatible input control bit Logic "LOW" = NORMAL Logic "HIGH" = INVERT	
9, 19	Vcc1, Vcc2	Supply Voltage	
10, 13, 14, 17	GND	These pins and package bottom must be connected to RF DC ground.	
11	NFIN	(These pins are AC coupled and must be DC Blocked externally.) Frequency Input	
12	FIN	Frequency Input Complement	
15	NFout	Frequency, output complement	
16	Fout	Frequency output	



HMC705LP4(E) Programming Truth Table

Division Ratio N	S0	N0	N1	N2	DIV 1	BYP
1	0	0	0	0	0	1
2	0	0	0	0	1	0
3	1	0	0	0	1	0
4	0	1	0	0	0	0
5	1	1	0	0	0	0
6	0	0	1	0	0	0
7	1	0	1	0	0	0
8	0	1	1	0	0	0
9	1	1	1	0	0	0
10	0	0	0	1	0	0
11	1	0	0	1	0	0
12	0	1	0	1	0	0
13	1	1	0	1	0	0
14	0	0	1	1	0	0
15	1	0	1	1	0	0
16	0	1	1	1	0	0
17	1	1	1	1	0	0

0 = Logic Low
1 = Logic High

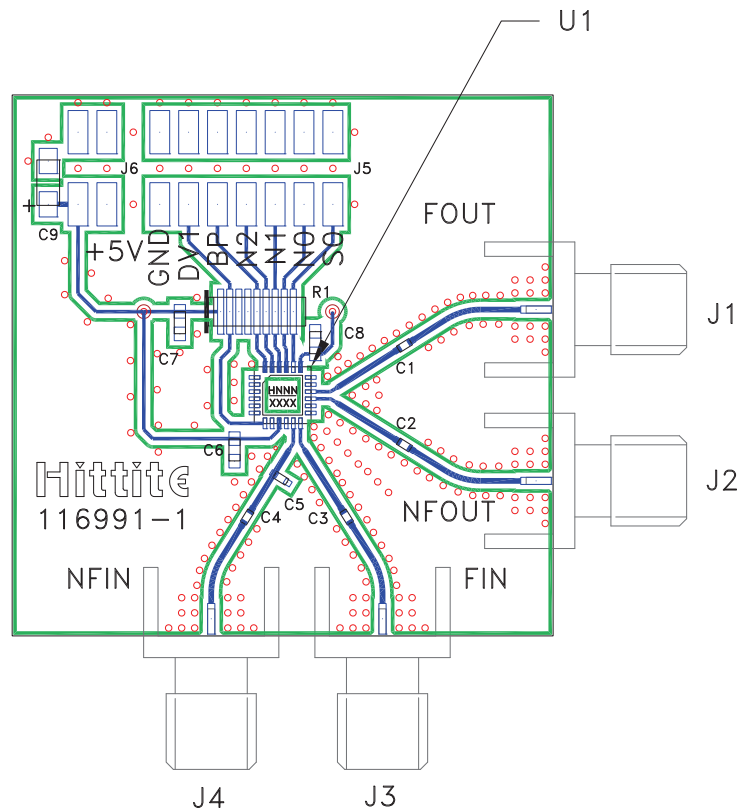

Evaluation PCB



**List of Materials for
Evaluation PCB 116993 [1]**

Item	Description
J1 - J4	PCB Mount SMA Connector
J5	14 Position Header
J6	4 Position Header
R1	10K Ohm Resistor Network, Bissel SMD
C1, C2	1000 pF Capacitor, 0402 Pkg.
C3 - C5	100 pF Capacitor, 0402 Pkg.
C6 - C8	1000 pF Capacitor, 0603 Pkg.
C9	4.7 μF Tantalum Capacitor, Case A
U1	HMC705LP4(E) Programmable Divider
PCB [2]	116991 Eval Board

[1] Reference this number when ordering complete evaluation PCB

[2] Circuit Board Material: Rogers 4350

The circuit board used in the application should use RF circuit design techniques. Signal lines should have 50 Ohm impedance while the package ground leads and backside ground paddle should be connected directly to the ground plane similar to that shown. A sufficient number of via holes should be used to connect the top and bottom ground planes. The evaluation circuit board shown is available from Hittite upon request.



Typical Application Showing Spurious Performance

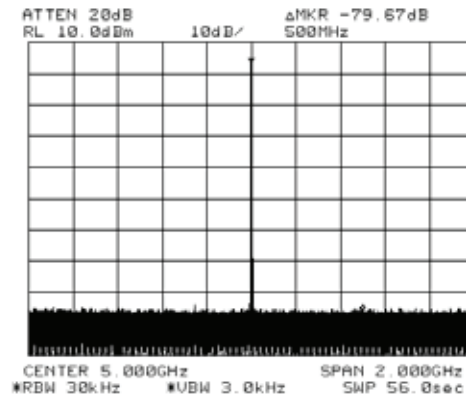

CMOS/TTL Input Characteristics

Maximum Input Logic "0" Voltage ($V_{IL\ MAXIMUM}$) = 1.1V @ 1 μ A.

Minimum Input Logic "1" Voltage ($V_{IH\ MINIMUM}$) = 1.8V @ 50 μ A.

Input IV characteristics for the logic inputs (S0, N0 - N2, DIV1, BYP) are shown below:

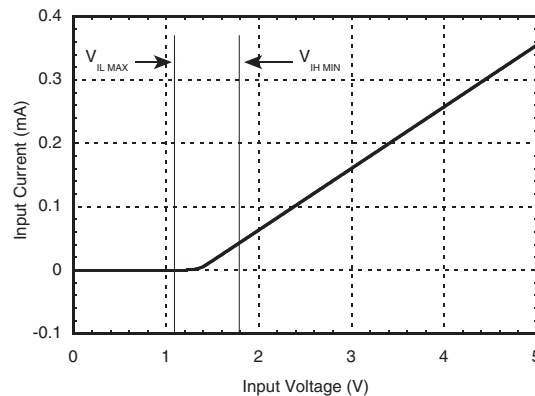

Компания «Life Electronics» занимается поставками электронных компонентов импортного и отечественного производства от производителей и со складов крупных дистрибьюторов Европы, Америки и Азии.

С конца 2013 года компания активно расширяет линейку поставок компонентов по направлению коаксиальный кабель, кварцевые генераторы и конденсаторы (керамические, пленочные, электролитические), за счёт заключения дистрибьюторских договоров

Мы предлагаем:

- Конкурентоспособные цены и скидки постоянным клиентам.
- Специальные условия для постоянных клиентов.
- Подбор аналогов.
- Поставку компонентов в любых объемах, удовлетворяющих вашим потребностям.
- Приемлемые сроки поставки, возможна ускоренная поставка.
- Доставку товара в любую точку России и стран СНГ.
- Комплексную поставку.
- Работу по проектам и поставку образцов.
- Формирование склада под заказчика.
- Сертификаты соответствия на поставляемую продукцию (по желанию клиента).
- Тестирование поставляемой продукции.
- Поставку компонентов, требующих военную и космическую приемку.
- Входной контроль качества.
- Наличие сертификата ISO.

В составе нашей компании организован Конструкторский отдел, призванный помогать разработчикам, и инженерам.

Конструкторский отдел помогает осуществить:

- Регистрацию проекта у производителя компонентов.
- Техническую поддержку проекта.
- Защиту от снятия компонента с производства.
- Оценку стоимости проекта по компонентам.
- Изготовление тестовой платы монтаж и пусконаладочные работы.



Тел: +7 (812) 336 43 04 (многоканальный)
Email: org@lifeelectronics.ru