

**RoHS** **Pb** **213 Series, 5 x 20 mm, Time-Lag (Slo-Blo®) Fuse**

### Description

5x20mm time-Lag surge withstand glass body cartridge fuse designed to IEC specification.









### Features

- Designed to International (IEC) Standards for use globally
- Available in cartridge and axial lead form
- Meets the IEC 60127-2, Sheet 3 specification for time-Lag fuses
- RoHS compliant and lead-free.

### Applications

Used as supplementary protection in appliance or utilization equipment to provide individual protection for components or internal circuits.









### Agency Approvals

Agency	Agency File Number	Ampere Range
	Cartridge Certificates: NBK120802-E10480 A&C Leaded Certificates: NBK120802-E10480 B&D	1A – 5A  6.3A
	Certificates: 2003010207045592	200mA – 6.3A
	Recognised File: E10480 Guide: JDYX2	200mA – 6.3A
	File: 029862 Acc. Class: LR1422-30	
	File: 915515,811747	
	License: 40015638	200mA – 4A, 6.3A
	License: KM41462	200mA – 6.3A
		200mA – 6.3A

### Electrical Characteristic for Series

% of Ampere Rating	Ampere Rating	Opening Time
150%	All Ratings	60 minutes, Minimum
210%		2 minutes, Maximum
275%		0.6 sec., Min.; 10 sec. Max.
400%		.15 sec., Min.; 3 sec. Max.
1000%		0.02 sec., Min.; 0.3 sec. Max.

### Electrical Characteristic Specifications by Item

Amp Code	Ampere Rating	Voltage Rating (V)	Interrupting Rating	Nominal Cold Resistance (Ohms)	Nominal Melting I <sup>2</sup> t (A <sup>2</sup> sec)	Nominal Voltage Drop (mV)	Nominal Power Dissipation (W)	Agency Approvals								
																
.200	0.2	250	35A@250Vac	1.6000	0.22500	1500	1.6	x	x		x	x	x	x	x	
.250	0.25	250		1.0495	0.55500	1300	1.6	x	x		x	x	x	x	x	x
.315	0.315	250		0.8475	1.14000	1100	1.6	x	x		x	x	x	x	x	x
.400	0.4	250		0.5350	1.36000	1000	1.6	x	x		x	x	x	x	x	x
.500	0.5	250		0.3700	2.90500	900	1.6	x	x		x	x	x	x	x	x
.630	0.63	250		0.2750	4.80000	300	1.6	x	x		x	x	x	x	x	x
.800	0.8	250		0.1635	9.42000	250	1.6	x	x		x	x	x	x	x	x
001.	1	250		0.1165	19.20000	150	1.6	x	x	x	x	x	x	x	x	x
1.25	1.25	250		0.0817	27.15000	150	1.6	x	x	x	x	x	x	x	x	x
01.6	1.6	250		0.0551	44.20000	150	1.6	x	x	x	x	x	x	x	x	x
002.	2	250		0.0452	92.70500	150	1.6	x	x	x	x	x	x	x	x	x
02.5	2.5	250		0.0305	138.00000	120	1.6	x	x	x	x	x	x	x	x	x
3.15	3.15	250		0.0231	202.00000	100	1.6	x	x	x	x	x	x	x	x	x
004.	4	250	40A@250Vac	0.0170	226.50500	100	1.6	x	x	x	x	x	x	x	x	
005.	5	250	50A@250Vac	0.0116	314.00000	100	1.6	x	x	x	x	x	x	x	x	
06.3	6.3	250	63A@250Vac	0.0095	600.00000	100	1.6	x	x	x	x	x	x	x	x	

### Temperature Derating Curve



### Average Time Current Curves



### Soldering Parameters - Wave Soldering

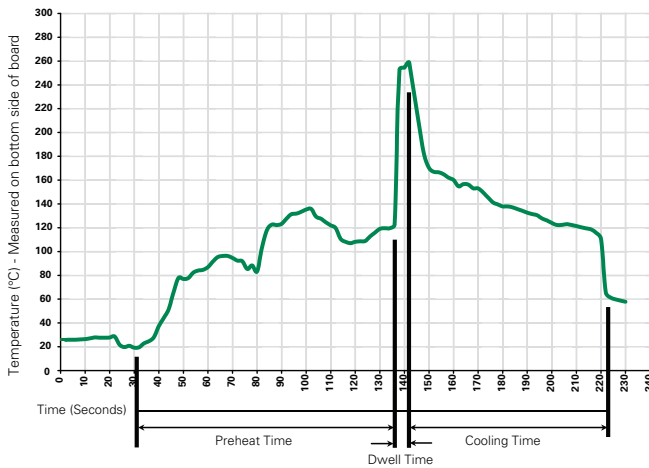

### Recommended Process Parameters:

Wave Parameter	Lead-Free Recommendation
<b>Preheat:</b> (Depends on Flux Activation Temperature)	(Typical Industry Recommendation)
Temperature Minimum:	100° C
Temperature Maximum:	150° C
Preheat Time:	60-180 seconds
<b>Solder Pot Temperature:</b>	260° C Maximum
<b>Solder Dwell Time:</b>	2-5 seconds

### Recommended Hand-Solder Parameters:

Solder Iron Temperature: 350° C +/- 5° C  
 Heating Time: 5 seconds max.

**Note: These devices are not recommended for IR or Convection Reflow process.**

### Product Characteristics

<b>Material</b>	Body: Glass Cap: Nickel-plated brass Leads: Tin-plated Copper
<b>Terminal Strength</b>	MIL-STD-202G, Method 211A, Test Condition A
<b>Solderability</b>	Reference IEC 60127, Second Edition 2003-01, Annex A
<b>Product Marking</b>	Cap1: Brand logo, current and voltage Cap2: Agency approval marks Series
<b>Packaging</b>	Available in Bulk (M=1000 pcs/pkg) or on Tape/Reel (MRET1=1000 pcs/reel)

<b>Operating Temperature</b>	-55°C to +125°C
<b>Thermal Shock</b>	MIL-STD-202G, Method 107G, Test Condition B: (5 cycles -65°C to +125°C)
<b>Vibration</b>	MIL-STD-202G, Method 201A
<b>Humidity</b>	MIL-STD-202G, Method 103B, Test Condition A. High RH (95%) and elevated temperature (40°C) for 240 hours.
<b>Salt Spray</b>	MIL-STD-202G, Method 101D, Test Condition B

### Dimensions

0213 000P

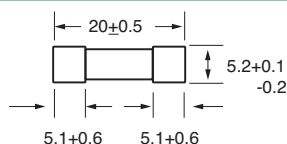

0213 000 XEP

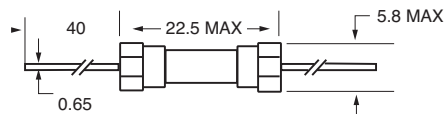

All dimensions in mm

Notes:

\* Ratings above 6.3A have 0.8 mm dia lead

### Part Numbering System

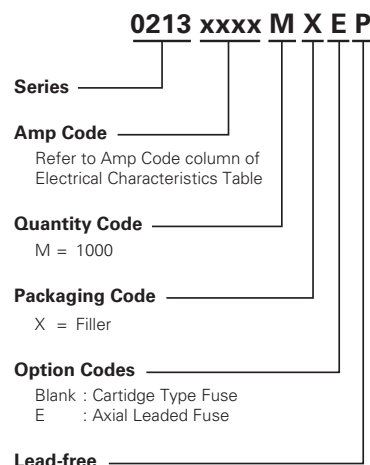

### Packaging

Packaging Option	Packaging Specification	Quantity	Quantity & Packaging Code	Taping Width
<b>213 Series</b>				
Bulk	N/A	1000	MX	N/A
Bulk	N/A	1000	MXE	N/A
Reel and Tape	N/A	1000	MRET1	T1=52mm (2.062")
Bulk	N/A	1000	MXG	N/A
Bulk	N/A	1000	MXB	N/A
Bulk	N/A	100	HX	N/A

Компания «Life Electronics» занимается поставками электронных компонентов импортного и отечественного производства от производителей и со складов крупных дистрибьюторов Европы, Америки и Азии.

С конца 2013 года компания активно расширяет линейку поставок компонентов по направлению коаксиальный кабель, кварцевые генераторы и конденсаторы (керамические, пленочные, электролитические), за счёт заключения дистрибьюторских договоров

Мы предлагаем:

- Конкуренспособные цены и скидки постоянным клиентам.
- Специальные условия для постоянных клиентов.
- Подбор аналогов.
- Поставку компонентов в любых объемах, удовлетворяющих вашим потребностям.
- Приемлемые сроки поставки, возможна ускоренная поставка.
- Доставку товара в любую точку России и стран СНГ.
- Комплексную поставку.
- Работу по проектам и поставку образцов.
- Формирование склада под заказчика.
- Сертификаты соответствия на поставляемую продукцию (по желанию клиента).
- Тестирование поставляемой продукции.
- Поставку компонентов, требующих военную и космическую приемку.
- Входной контроль качества.
- Наличие сертификата ISO.

В составе нашей компании организован Конструкторский отдел, призванный помогать разработчикам, и инженерам.

Конструкторский отдел помогает осуществить:

- Регистрацию проекта у производителя компонентов.
- Техническую поддержку проекта.
- Защиту от снятия компонента с производства.
- Оценку стоимости проекта по компонентам.
- Изготовление тестовой платы монтаж и пусконаладочные работы.



Тел: +7 (812) 336 43 04 (многоканальный)  
Email: [org@lifeelectronics.ru](mailto:org@lifeelectronics.ru)