

**SERIES: PBK-1 | DESCRIPTION: AC-DC POWER SUPPLY**
**FEATURES**

- up to 1 W continuous output
- compact SIP package
- single regulated outputs from 5~24 V
- 3,000 Vac isolation
- over current and short circuit protections
- CE, UL60950-1 safety approval
- wide input voltage: 70~400 Vdc (85~264 Vac)
- efficiency up to 68%

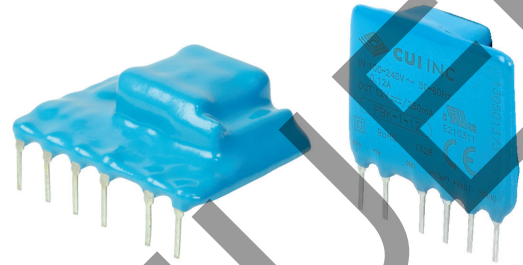

MODEL	output voltage	output current max	output power max	ripple and noise <sup>1</sup> max	efficiency <sup>2</sup> typ
	(Vdc)	(mA)	(W)	(mVp-p)	(%)
PBK-1-5	5	200	1	150	61
PBK-1-9	9	111	1	150	66
PBK-1-12	12	83	1	150	67
PBK-1-15	15	67	1	150	67
PBK-1-24	24	42	1	150	68

Note: 1. Measured at 20 MHz bandwidth, see Test Configuration section.  
2. At 230 Vac.

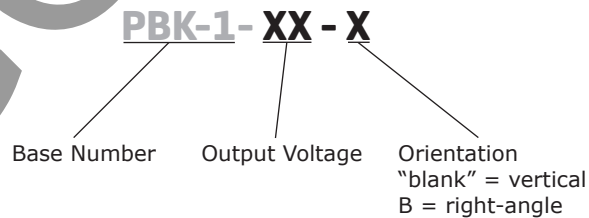
**PART NUMBER KEY**

**INPUT**

parameter	conditions/description	min	typ	max	units
voltage		85 70		264 400	Vac Vdc
frequency		47		63	Hz
current	at 115 Vac at 230 Vac			120 60	mA mA
inrush current	at 115 Vac at 230 Vac		10 20		A A
no load power consumption				0.5	W
input fuse	1 A/250 V, slow-blow type (external, required)				

**OUTPUT**

parameter	conditions/description	min	typ	max	units
output current		10			%
capacitive load	5 Vdc output models 9 Vdc output models all other models			470 150 100	$\mu$ F $\mu$ F $\mu$ F
line regulation	at full load		$\pm 1.5$	$\pm 2$	%
load regulation	at 10%~100% load		$\pm 2.5$	$\pm 3$	%
voltage set accuracy	5 Vdc output models all other models			$\pm 10$ $\pm 5$	% %
hold-up time	at 115 Vac at 230 Vac	80 300			ms ms
switching frequency				50	kHz
temperature coefficient			$\pm 0.1$		%/°C

**PROTECTIONS**

parameter	conditions/description	min	typ	max	units
short circuit protection	hiccup, continuous, auto restart				
over current protection	auto restart	120			%

**SAFETY & COMPLIANCE**

parameter	conditions/description	min	typ	max	units
isolation voltage	input to output, for 1 minute	3,000			Vac
safety approvals	UL60950-1, CE				
safety class	Class II				
conducted emissions	CISPR32/EN55032 external circuit required, Class A (see figure 2); Class B (see figure 3)				
radiated emissions	CISPR32/EN55032 external circuit required, Class A (see figure 2); Class B (see figure 3)				
ESD	IEC/EN61000-4-2 Class B, contact $\pm 4$ kV				
radiated immunity	IEC/EN61000-4-3 Class A, 10V/m (external circuit required, see figure 3)				
EFT/burst	IEC/EN61000-4-4 Class B, $\pm 2$ kV (external circuit required, see figure 2)				
surge	IEC/EN61000-4-4 Class B, $\pm 4$ kV (external circuit required, see figure 3)				
surge	IEC/EN61000-4-5 Class B, $\pm 1$ kV/ $\pm 2$ kV (external circuit required, see figure 3)				
conducted immunity	IEC/EN61000-4-6 Class A, 3 Vr.m.s (external circuit required, see figure 3)				
voltage dips & interruptions	IEC/EN61000-4-11 Class B, 0%-70% (external circuit required, see figure 3)				
MTBF	as per MIL-HDBK-217F, 25°C	300,000			hours
RoHS	2011/65/EU				

## ENVIRONMENTAL

parameter	conditions/description	min	typ	max	units
operating temperature		-25		85	°C
storage temperature		-25		105	°C
humidity	non-condensing			85	%

## EFFICIENCY CURVES

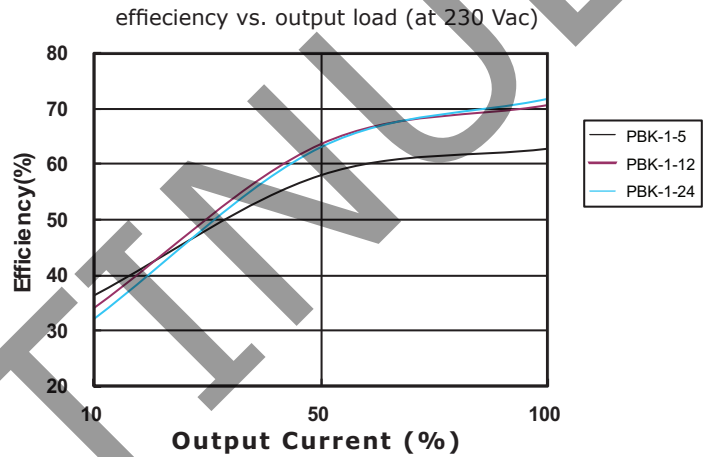
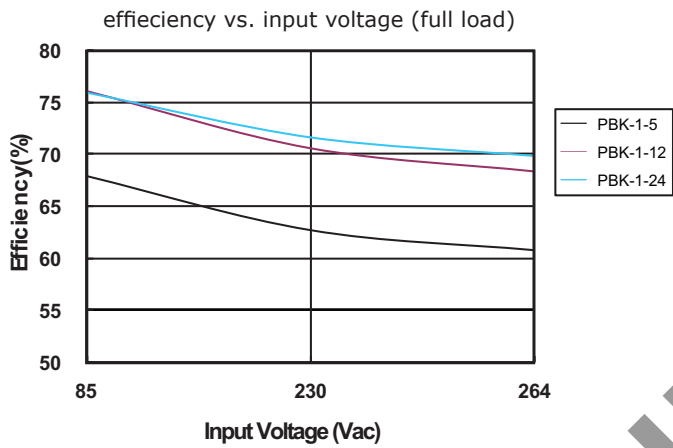

## SOLDERABILITY

parameter	conditions/description	min	typ	max	units
hand soldering	for 3~5 seconds	350	360	370	°C
wave soldering	for 5~10 seconds	255	260	265	°C

## MECHANICAL

parameter	conditions/description	min	typ	max	units
dimensions	vertical: 35 x 11 x 25 right-angle: 35 x 13 x 25				mm mm
material	UL94V-0				
weight			8		g

## MECHANICAL DRAWING

### VERTICAL ORIENTATION

units: mm[inch]  
 tolerance:  $\pm 0.5[\pm 0.020]$   
 pin tolerance:  $\pm 0.1[\pm 0.004]$

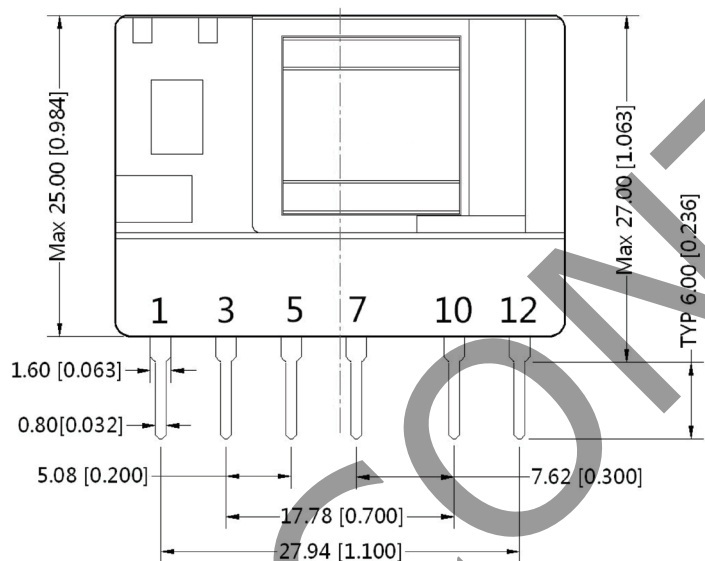

Front View

Note: Grid 2.54\*2.54mm  
 $\varnothing 1.30 [\varnothing 0.051]$

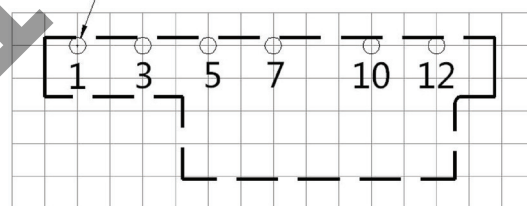

Top View  
 PCB Layout

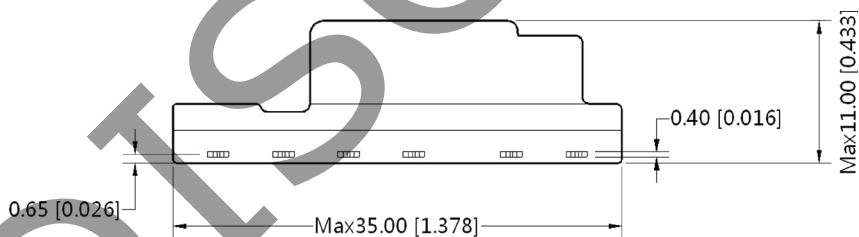

Bottom View

PIN CONNECTIONS	
PIN	FUNCTION
1	-Vin (N)
3	+Vin (L)
5	+V(CAP)
7	-V(CAP)
10	-Vo
12	+Vo

Note: 1. It is required to add C1 between pins 5 & 7 (see application circuits).

## MECHANICAL DRAWING (CONTINUED)

### RIGHT-ANGLE ORIENTATION

units: mm[inch]  
 tolerance:  $\pm 0.5[\pm 0.020]$   
 pin tolerance:  $\pm 0.1[\pm 0.004]$

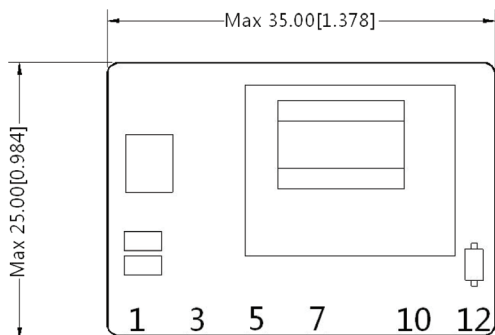

Front View

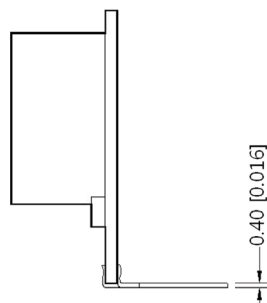

Side View

Note: Grid 2.54\*2.54mm

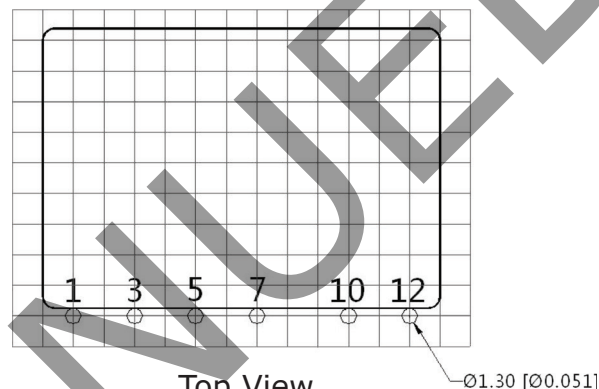

Top View  
PCB Layout

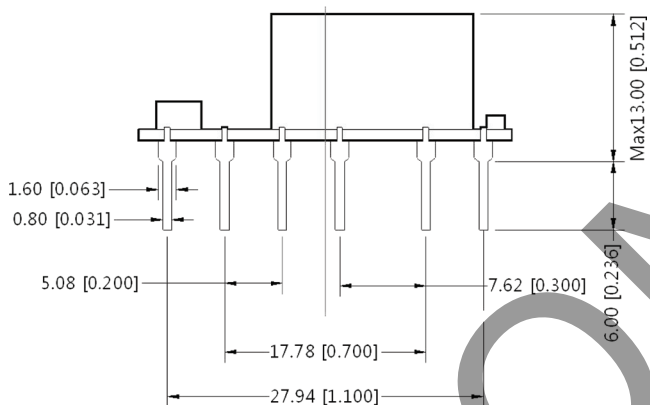

Bottom View

PIN CONNECTIONS	
PIN	FUNCTION
1	-Vin (N)
3	+Vin (L)
5	+V(CAP)
7	-V(CAP)
10	-Vo
12	+Vo

Note: 1. It is required to add C1 between pins 5 & 7 (see application circuits).

## TEST CONFIGURATION

Figure 1  
Connect Oscillograph Probe

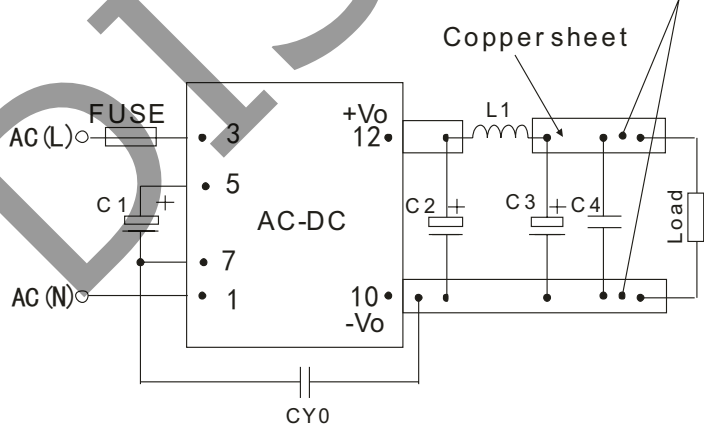

Table 1

Recommended External Circuit Components						
$V_{OUT}$ (Vdc)	C1 <sup>1</sup>	C2 <sup>1</sup>	L1 <sup>1</sup>	C3 <sup>1</sup>	C4	CY0 (Y1 capacitor)
5	10 $\mu$ F/400V	150 $\mu$ F/35V	2.2 $\mu$ H	68 $\mu$ F/35V	0.1 $\mu$ F/50V	1nF/400Vac
9	10 $\mu$ F/400V	150 $\mu$ F/35V	2.2 $\mu$ H	68 $\mu$ F/35V	0.1 $\mu$ F/50V	1nF/400Vac
12	10 $\mu$ F/400V	100 $\mu$ F/35V	2.2 $\mu$ H	68 $\mu$ F/35V	0.1 $\mu$ F/50V	1nF/400Vac
15	10 $\mu$ F/400V	100 $\mu$ F/35V	2.2 $\mu$ H	68 $\mu$ F/35V	0.1 $\mu$ F/50V	1nF/400Vac
24	10 $\mu$ F/400V	100 $\mu$ F/35V	2.2 $\mu$ H	68 $\mu$ F/35V	0.1 $\mu$ F/50V	1nF/400Vac

Note: 1. Required components.  
 2. 1 A/250 V fuse required.

## TYPICAL APPLICATION CIRCUIT

Figure 2

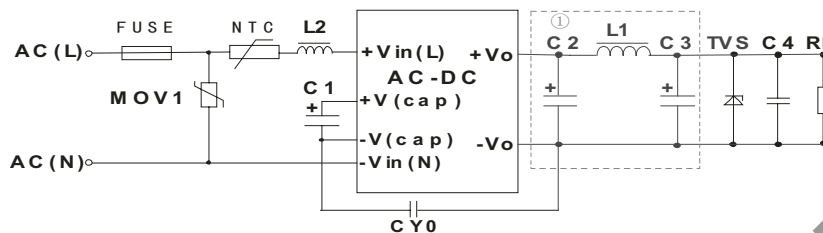

Table 2

Recommended External Circuit Components												
$V_{OUT}$ (Vdc)	C1 <sup>1</sup>	L2	C2 <sup>1,2</sup>	L1 <sup>1</sup>	C3 <sup>1</sup>	C4	CY0	FUSE <sup>1</sup>	TVS	NTC	MOV1	
5	10 $\mu$ F/400V	4.7mH	150 $\mu$ F/35V	2.2 $\mu$ H	68 $\mu$ F/35V	0.1 $\mu$ F/50V	1nF/400Vac	1A/250V	SMBJ7.0A	5D-9	S14K350	
9	10 $\mu$ F/400V	4.7mH	150 $\mu$ F/35V	2.2 $\mu$ H	68 $\mu$ F/35V	0.1 $\mu$ F/50V	1nF/400Vac	1A/250V	SMBJ12A	5D-9	S14K350	
12	10 $\mu$ F/400V	4.7mH	100 $\mu$ F/35V	2.2 $\mu$ H	68 $\mu$ F/35V	0.1 $\mu$ F/50V	1nF/400Vac	1A/250V	SMBJ20A	5D-9	S14K350	
15	10 $\mu$ F/400V	4.7mH	100 $\mu$ F/35V	2.2 $\mu$ H	68 $\mu$ F/35V	0.1 $\mu$ F/50V	1nF/400Vac	1A/250V	SMBJ20A	5D-9	S14K350	
24	10 $\mu$ F/400V	4.7mH	100 $\mu$ F/35V	2.2 $\mu$ H	68 $\mu$ F/35V	0.1 $\mu$ F/50V	1nF/400Vac	1A/250V	SMBJ30A	5D-9	S14K350	

Note: 1. Required components.  
2. When 5 Vdc model is operating in the -25~0C or 55~85C range, C2 needs to be a 270  $\mu$ F/16 V solid capacitor.

## EMC RECOMMENDED CIRCUIT

Figure 3

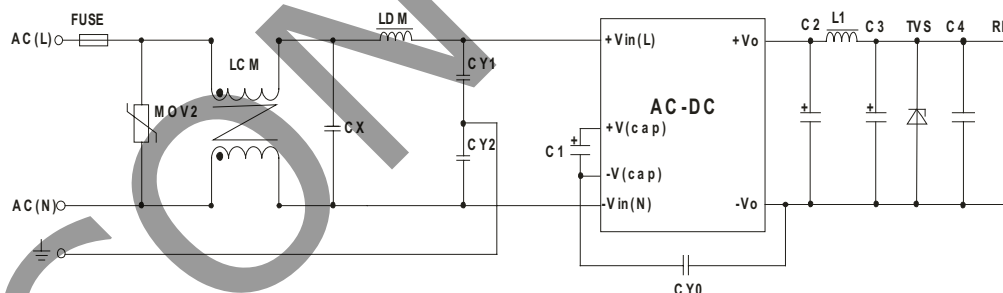

Table 3

Recommended External Circuit Components	
MOV2	S14K350
CY1, CY2	1nF/400Vac
CX	0.1 $\mu$ F/275Vac
LCM	3.5mH
LDM	5mH
FUSE	1A/250V, slow blow

Note: Also refer to Table 2.

- Notes:
- C1 and C3 are electrolytic capacitors. They are required for both AC input and DC input.
  - For AC input, C1 is used as a filter capacitor. The recommended C1 value is 10  $\mu$ F/400 V.
  - For DC input, C1 is used as an EMC filter capacitor. The recommended C1 value is 10 $\mu$ F/450V. When the input voltage is above 370VDC, we recommend a 10 $\mu$ F/450V capacitor.
  - C2 and C3 are output filter capacitors, we recommend high frequency and low impedance electrolytic capacitors. For capacitance and rated ripple current of capacitors refer to the datasheets provided by the manufacturers, voltage derating of capacitors should be 80% or above.
  - C4 is a ceramic capacitor which is used to filter high frequency noise. C2, C3 and L1 form a pi-type filter circuit. For current of L1 and L2 refer to the datasheets provided by the manufacturers, current derating should be 80% or above. TVS is a recommended component to protect post-circuits (if converter fails). We recommend using a 5D-9 external input NTC.
  - For standard EMC requirements, please refer to figure 2. If a higher EMC is required, please refer to figure 3.
  - All specifications measured at Ta=25C, humidity <75%, 115 Vac & 230 Vac input voltage, and rated output load, unless otherwise specified.

## REVISION HISTORY

rev.	description	date
1.0	initial release	08/09/2013
1.01	added bent pin model options, updated emc recommendations	03/25/2014
1.02	performance updates due to control IC change	02/02/2018

The revision history provided is for informational purposes only and is believed to be accurate.



**Headquarters**  
20050 SW 112th Ave.  
Tualatin, OR 97062  
**800.275.4899**

Fax 503.612.2383  
**cui.com**  
techsupport@cui.com

CUI offers a two (2) year limited warranty. Complete warranty information is listed on our website.

CUI reserves the right to make changes to the product at any time without notice. Information provided by CUI is believed to be accurate and reliable. However, no responsibility is assumed by CUI for its use, nor for any infringements of patents or other rights of third parties which may result from its use.

CUI products are not authorized or warranted for use as critical components in equipment that requires an extremely high level of reliability. A critical component is any component of a life support device or system whose failure to perform can be reasonably expected to cause the failure of the life support device or system, or to affect its safety or effectiveness.

Компания «Life Electronics» занимается поставками электронных компонентов импортного и отечественного производства от производителей и со складов крупных дистрибьюторов Европы, Америки и Азии.

С конца 2013 года компания активно расширяет линейку поставок компонентов по направлению коаксиальный кабель, кварцевые генераторы и конденсаторы (керамические, пленочные, электролитические), за счёт заключения дистрибьюторских договоров

Мы предлагаем:

- Конкуренеспособные цены и скидки постоянным клиентам.
- Специальные условия для постоянных клиентов.
- Подбор аналогов.
- Поставку компонентов в любых объемах, удовлетворяющих вашим потребностям.
- Приемлемые сроки поставки, возможна ускоренная поставка.
- Доставку товара в любую точку России и стран СНГ.
- Комплексную поставку.
- Работу по проектам и поставку образцов.
- Формирование склада под заказчика.
- Сертификаты соответствия на поставляемую продукцию (по желанию клиента).
- Тестирование поставляемой продукции.
- Поставку компонентов, требующих военную и космическую приемку.
- Входной контроль качества.
- Наличие сертификата ISO.

В составе нашей компании организован Конструкторский отдел, призванный помогать разработчикам, и инженерам.

Конструкторский отдел помогает осуществить:

- Регистрацию проекта у производителя компонентов.
- Техническую поддержку проекта.
- Защиту от снятия компонента с производства.
- Оценку стоимости проекта по компонентам.
- Изготовление тестовой платы монтаж и пусконаладочные работы.



Тел: +7 (812) 336 43 04 (многоканальный)

Email: [org@lifeelectronics.ru](mailto:org@lifeelectronics.ru)