

DUAL OUTPUT STRATUM-III SMD TCXO & VCTCXO

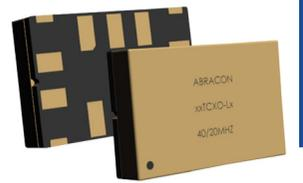

9.0 x 14.0 x 3.0mm

Pb RoHS/RoHS II Compliant

ESD SENSITIVE

MSL = 3

ABDFTCXO/ABDFVCTCXO SERIES

FEATURES

- Phase and frequency coherent dual output
- F0 and F0÷2 with integrated precision fanout buffers
- Meets ±280ppb Stratum-III stability requirements
- Excellent ±1ppm aging with ±4.6ppm guaranteed lifetime accuracy
- 5 to 52MHz standard and custom frequencies available
- TCXO or VCTCXO functionality available
- ±5ppm minimum pull with 0.5% typ linearity (VCTCXO only)
- LVC MOS outputs
- 10pin package
- -40°C to 85°C operation

APPLICATIONS

- Communications and Networking
- Synchronization
- PLL with Holdover
- Geolocation, RTLS, GPS
- Synchronous Ethernet
- IEEE1588
- Instrumentation, test and measurement
- Femtocells, picocells (BTS)
- Oil and gas exploration

TYPICAL OPERATING CIRCUIT

DIGITAL FPGA BASED PLL WITH PRECISION STRATUM-III HOLDOVER

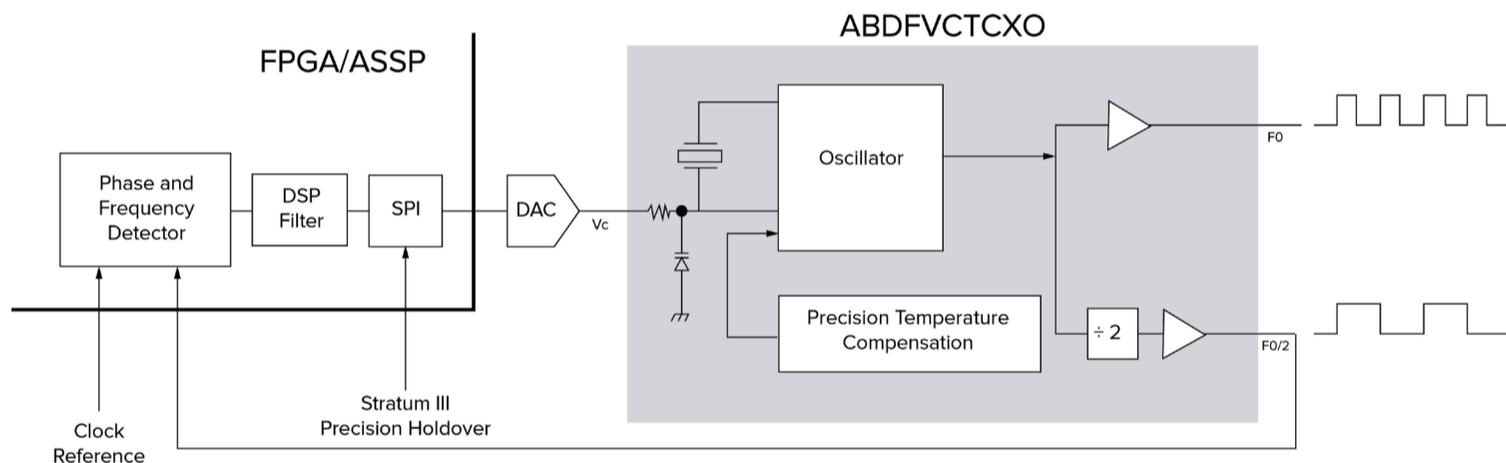

OPTIONS AND PART IDENTIFICATION

ABDFTCXO OR ABDFVCTCXO - MHz - - -

OUTPUT 1 (F₀) IN MHZ
Please specify the frequency
Output 1 (F0) in MHz e.g.
16.384MHz

*F0 > 40MHz, available in Q4-2017

OPERATING TEMP. RANGE
E: -20°C to +70°C
L: -40°C to +85°C

FREQ. STABILITY
1: ±100ppb*
2: ±280ppb

*Available Q4-2017

PACKAGING
Blank: Bulk**
T5: 500 pcs/reel
T2: 250 pcs/reel
CT: Cut Tape***

**Bulk devices are not in MSL-3 compliant packaging

***Cut Tape devices available in 25pc, 50pc, & 100pc quantities (MSL-3 compliant)



5101 Hidden Creek Ln Spicewood TX 78669
Phone: 512-371-6159 | Fax: 512-351-8858
For terms and conditions of sales, please visit:
www.abracon.com

REVISED: 05.19.2017

ABRACON IS
ISO9001-2008
CERTIFIED

DUAL OUTPUT STRATUM-III SMD TCXO & VCTCXO



ABDFTCXO/ABDFVCTCXO SERIES

9.0 x 14.0 x 3.0mm

RoHS/RoHS II Compliant

ESD SENSITIVE

MSL = 3

STANDARD SPECIFICATIONS

PARAMETERS	RATING
Storage Temperature Range (Ts)	-55°C to +125°C
Supply Voltage (Vdd)	-0.5V to 6V
Control Voltage (Vc)	0V to 3V
ESD, HBM/CDM/MM	4kV/2kV/200V

PARAMETERS	MINIMUM	TYPICAL	MAXIMUM	UNITS	NOTES
Frequency Range	5.000		52.000	MHz	
Standard Frequencies [Output 1(F ₀)/Output 2 (F ₀ /2)]	10.000/5.000 16.384/8.192 20.000/10.000 26.000/13.000 38.400/19.200 50.000/25.000	12.800/6.400 19.200/9.600 24.576/12.288 30.000/15.000 38.880/19.440 52.000/26.000	16.000/8.000 19.440/9.720 25.000/12.500 30.720/15.360 40.000/20.000	MHz	Custom frequencies available upon request. Please contact Abracon. *Note 1
Supply Voltage (Vdd)	+3.135	+3.3	+3.465	V	
Supply Current (Icc) (into 15pF load)			20	mA	Carrier dependent
Initial Frequency Tolerance @ +25°C	-0.50		+0.50	ppm	As received, Relative to carrier
Operating Temperature	-20		+70	°C	Option "E"
	-40		+85		Option "L"
Frequency Stability vs. Operating Temperature (ref. to +25°C)	-100		+100	ppb	Option "1" *Note 2
	-280		+280	ppb	Option "2"
Frequency Stability vs. Vdd Change	-100		+100	ppb	Vdd ±5%
Frequency Stability vs. Load Change	-200		+200	ppb	Load ±5%
Aging (1 st year @ +25°C)	-1.0		+1.0	ppm	
Aging (10 years @ +25°C)	-3.0		+3.0	ppm	
All-inclusive frequency stability over 10 years product life (Stratum-III Compliant)	-4.60		+4.60	ppm	
LVC MOS Output (Square wave)					
V _{OH}	2.4			V	Load = 15pF
V _{OL}			0.4	V	Load = 15pF
Load			15	pF	
Duty Cycle	45		55	%	@ (V _{OH} - V _{OL})/2
Rise/Fall Time			6	ns	Load = 15pF
Control Port (Applicable for VCTCXO only)					
Center Control Voltage (Vc)		+1.50		V	
Control Voltage Range (Vc)	+0.50		+2.50	V	
Frequency Pull	±5.00		< ±13.00	ppm	Vc = 1.5V±1.0V
Tuning Slope		Positive			
Linearity Error		< 0.5	10	%	

*Note 1: F₀ > 40MHz, available in Q4-2017 | *Note 2: Available Q4-2017

DUAL OUTPUT STRATUM-III SMD TCXO & VCTCXO

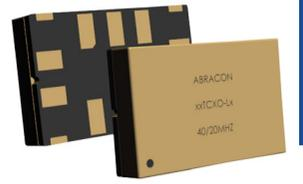

ABDFTCXO/ABDFVCTCXO SERIES

9.0 x 14.0 x 3.0mm

RoHS/RoHS II Compliant

ESD SENSITIVE

MSL = 3

STANDARD SPECIFICATIONS (CONT.)

PARAMETERS	MINIMUM	TYPICAL	MAXIMUM	UNITS	NOTES
RMS Jitter (12kHz ~ 20MHz BW) @ 25°C					
16.384 MHz Carrier		650	1,300	fs	
20.000 MHz Carrier		525	1,300	fs	
10.000 MHz Carrier		650	1,300	fs	
26.000 MHz Carrier		450	1,300	fs	
13.000 MHz Carrier		775	1,300	fs	
40.000 MHz Carrier		325	1,300	fs	
20.000 MHz Carrier		450	1,300	fs	
Phase Noise					
F ₀ @ 20.000 MHz		-85		dBc/Hz	Offset @10Hz
		-100			Offset @100Hz
		-135			Offset @1kHz
		-145			Offset @10kHz
		-150			Offset @100kHz
		-155			Offset @ 5MHz
F ₀ /2 @ 10.000 MHz		-90		dBc/Hz	Offset @10Hz
		-100			Offset @100Hz
		-135			Offset @1kHz
		-145			Offset @10kHz
		-150			Offset @100kHz
		-155			Offset @ 5MHz
F ₀ @ 26.000 MHz		-85		dBc/Hz	Offset @10Hz
		-100			Offset @100Hz
		-135			Offset @1kHz
		-145			Offset @10kHz
		-150			Offset @100kHz
		-150			Offset @ 5MHz
F ₀ /2 @ 13.000 MHz		-75		dBc/Hz	Offset @10Hz
		-100			Offset @100Hz
		-135			Offset @1kHz
		-150			Offset @10kHz
		-150			Offset @100kHz
		-155			Offset @ 5MHz
F ₀ @ 40.000 MHz		-80		dBc/Hz	Offset @10Hz
		-100			Offset @100Hz
		-125			Offset @1kHz
		-140			Offset @10kHz
		-150			Offset @100kHz
		-150			Offset @ 5MHz
F ₀ /2 @ 20.000 MHz		-80		dBc/Hz	Offset @10Hz
		-100			Offset @100Hz
		-135			Offset @1kHz
		-140			Offset @10kHz
		-145			Offset @100kHz
		-155			Offset @ 5MHz

DUAL OUTPUT STRATUM-III SMD TCXO & VCTCXO

ABDFTCXO/ABDFVCTCXO SERIES

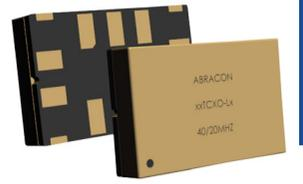

9.0 x 14.0 x 3.0mm

Pb RoHS/RoHS II Compliant

ESD SENSITIVE

MSL = 3

TYPICAL PHASE NOISE & JITTER CHARACTERISTICS

16.384MHz
[Output 1 (F0)]

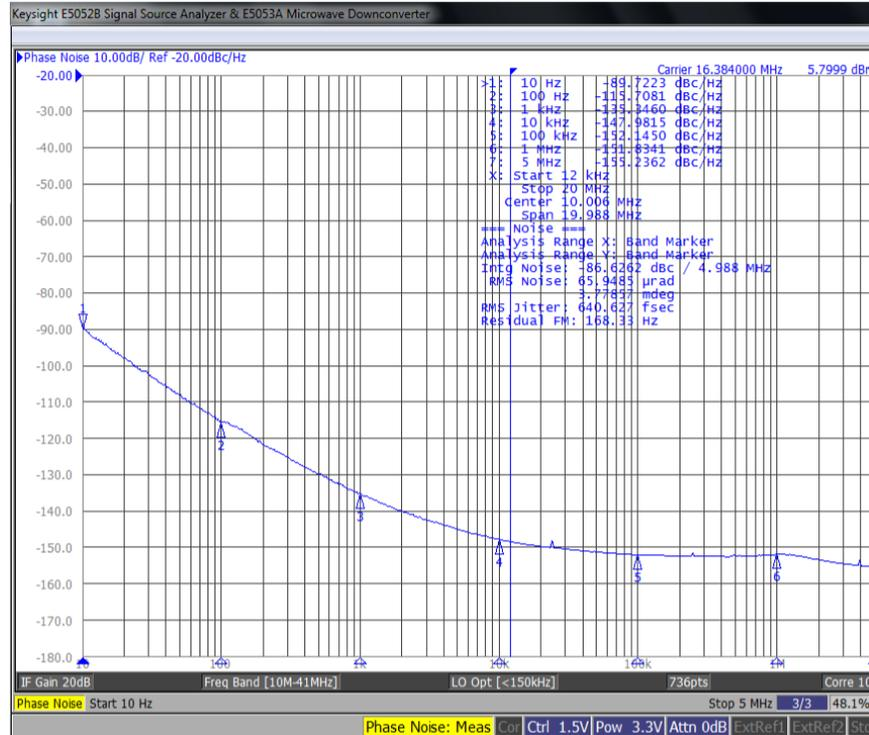

20.000MHz / 10.000MHz
[Output 1 (F0) / Output 2 (F0/2)]

20.000MHz

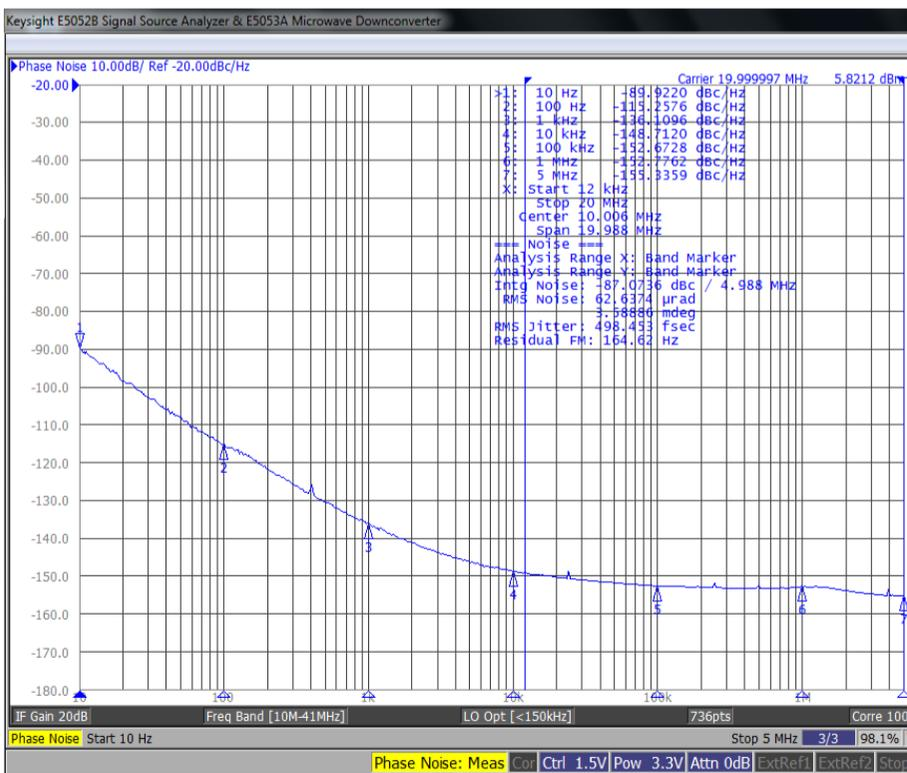

10.000MHz

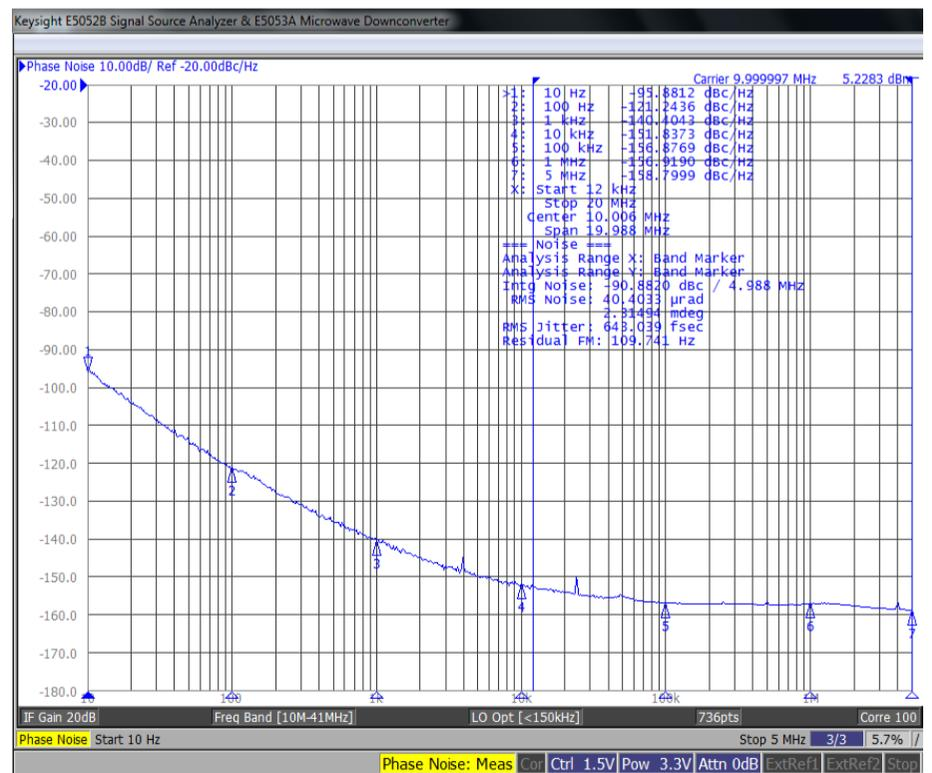

REVISED: 05.19.2017



5101 Hidden Creek Ln Spicewood TX 78669
Phone: 512-371-6159 | Fax: 512-351-8858
For terms and conditions of sales, please visit:
www.abracon.com

ABRACON IS
ISO9001-2008
CERTIFIED

DUAL OUTPUT STRATUM-III SMD TCXO & VCTCXO

ABDFTCXO/ABDFVCTCXO SERIES

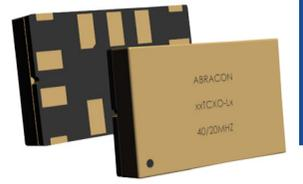

9.0 x 14.0 x 3.0mm

Pb RoHS/RoHS II Compliant

ESD SENSITIVE

MSL = 3

TYPICAL PHASE NOISE & JITTER CHARACTERISTICS

26.000MHz
26.000MHz / 13.000MHz
[Output 1 (F0) / Output 2 (F0/2)]

13.000MHz

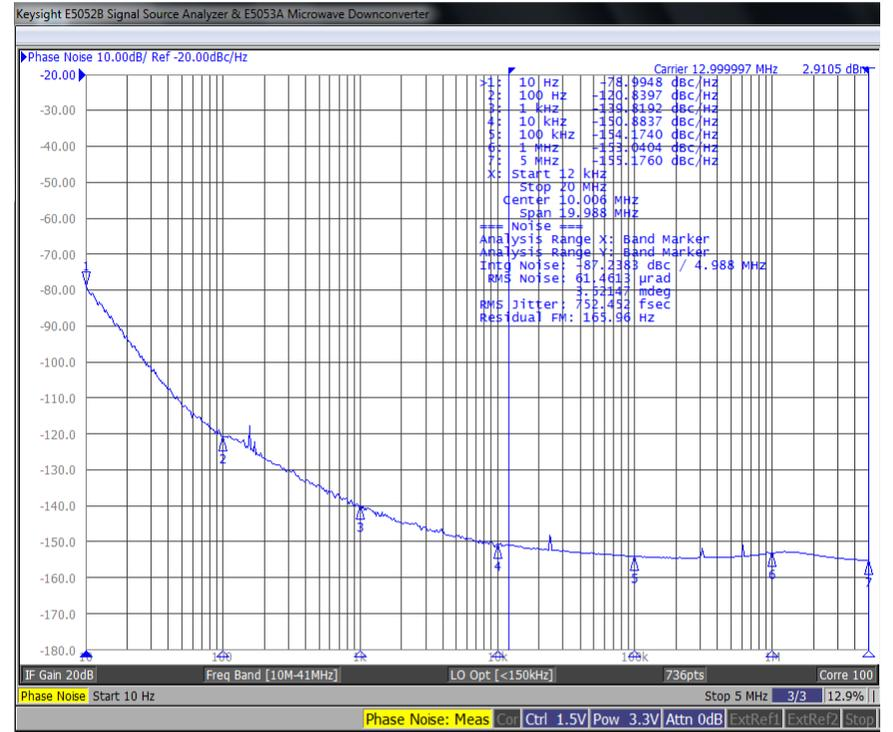
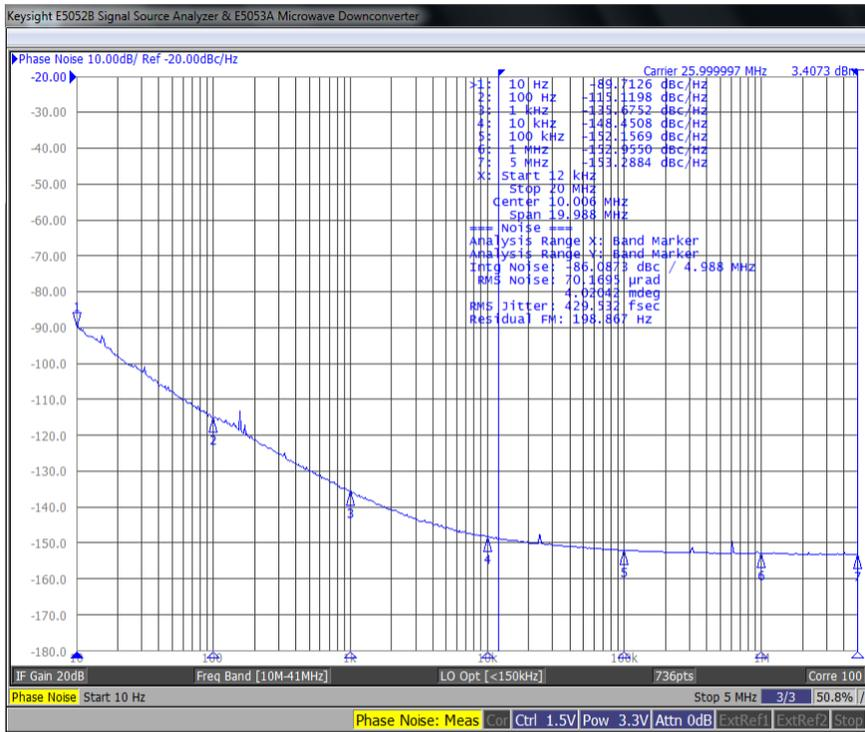

40.000MHz
40.000MHz / 20.000MHz
[Output 1 (F0) / Output 2 (F0/2)]

20.000MHz

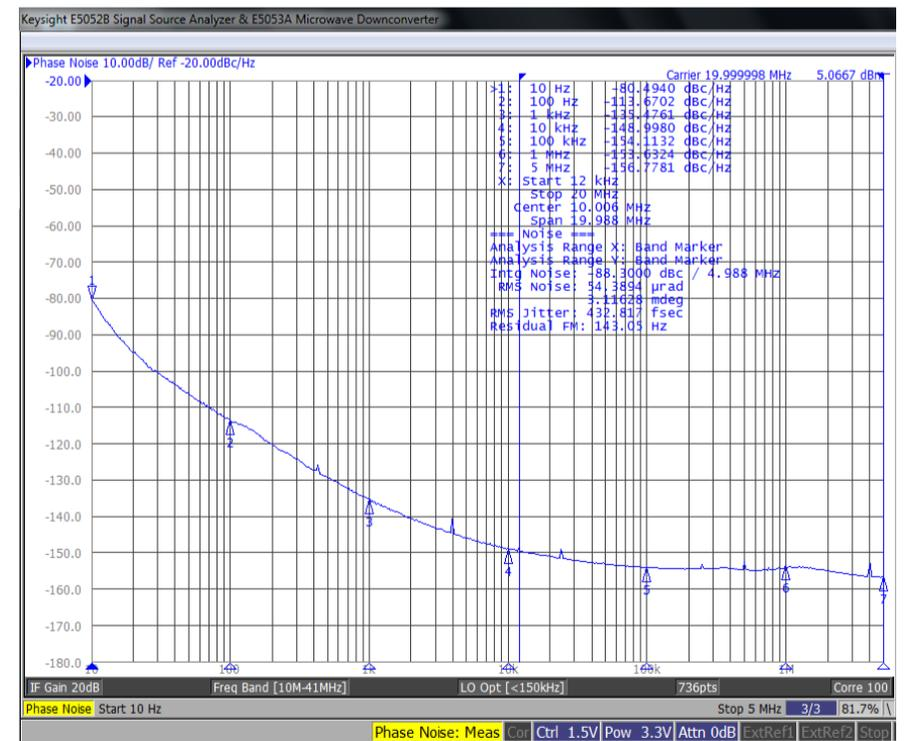
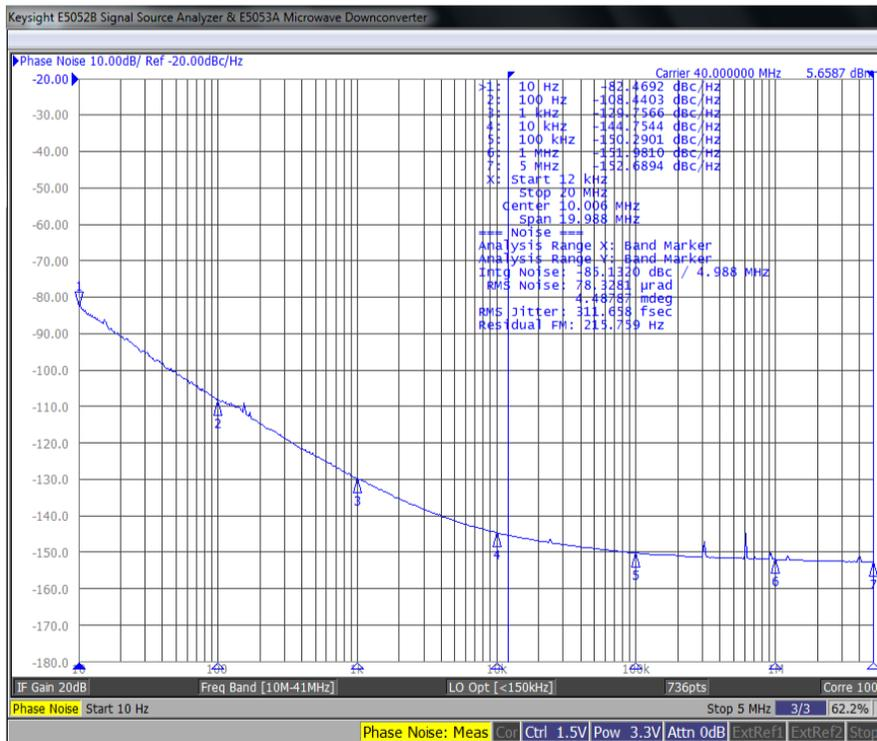

Frequency	16.384MHz	20MHz	10MHz	26MHz	13MHz	40MHz	20MHz
Typical rms Phase Jitter (12kHz to 20MHz BW)	640 fs	498 fs	643 fs	429 fs	752 fs	311 fs	432 fs

REVISED: 05.19.2017



5101 Hidden Creek Ln Spicewood TX 78669
Phone: 512-371-6159 | Fax: 512-351-8858
For terms and conditions of sales, please visit:
www.abracon.com

ABRACON IS
ISO9001-2008
CERTIFIED

DUAL OUTPUT STRATUM-III SMD TCXO & VCTCXO

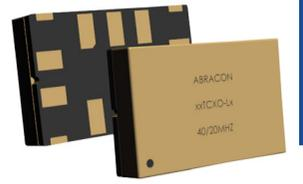

ABDFTCXO/ABDFVCTCXO SERIES

9.0 x 14.0 x 3.0mm

RoHS/RoHS II Compliant

ESD SENSITIVE

MSL = 3

FREQUENCY STABILITY VS. TEMPERATURE

FREQUENCY PULL VS. CONTROL VOLTAGE (VCTCXO MODE)

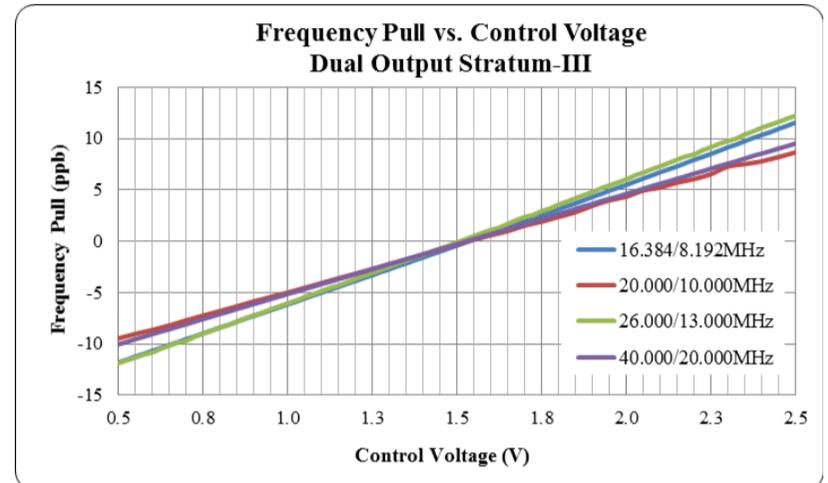
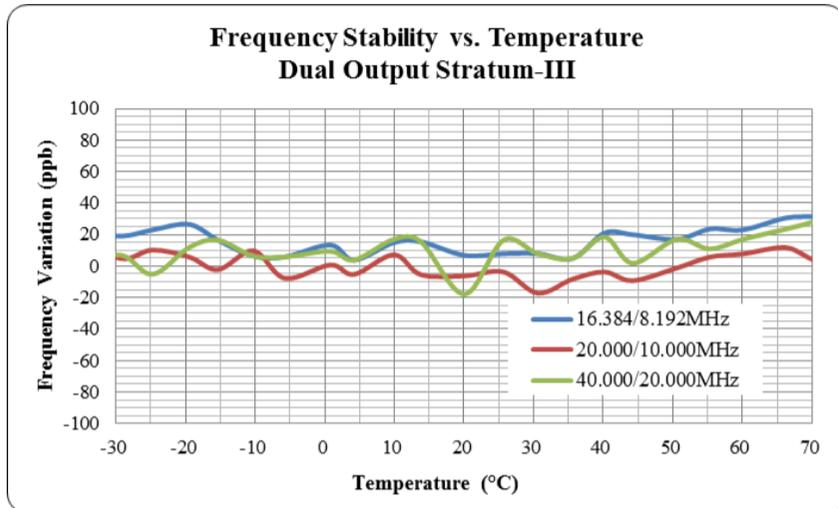

AGING PROFILE (ACCELERATED AGING @ +85°C)

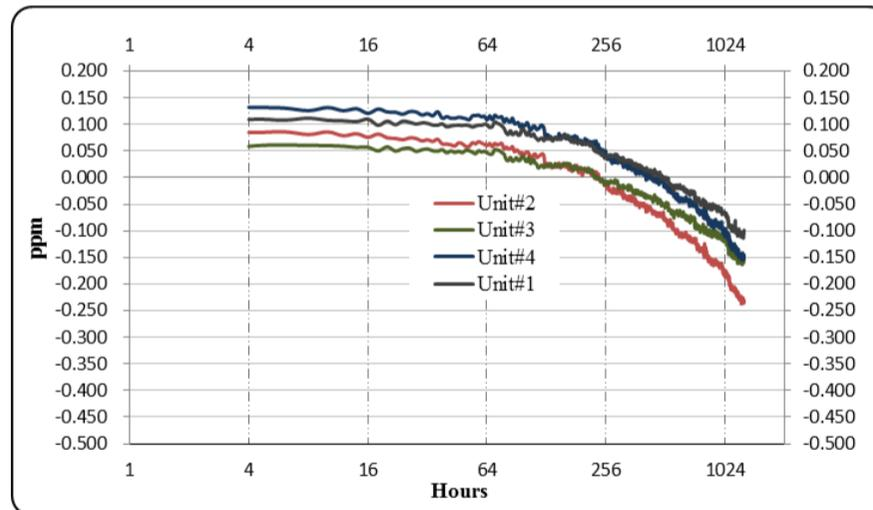

DUAL OUTPUT STRATUM-III SMD TCXO & VCTCXO

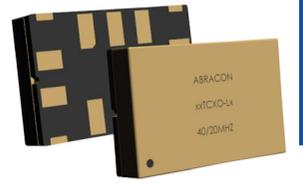

ABDFTCXO/ABDFVCTCXO SERIES

9.0 x 14.0 x 3.0mm

RoHS/RoHS II Compliant

ESD SENSITIVE

MSL = 3

TYPICAL PHASE NOISE & JITTER CHARACTERISTICS

RECOMMENDED LAND PATTERN

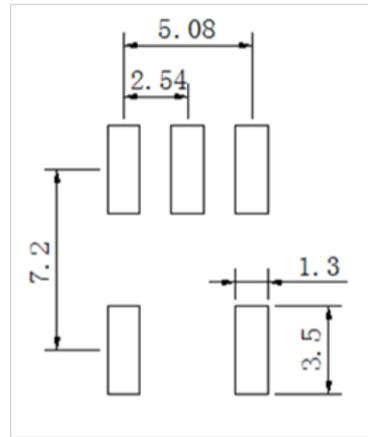
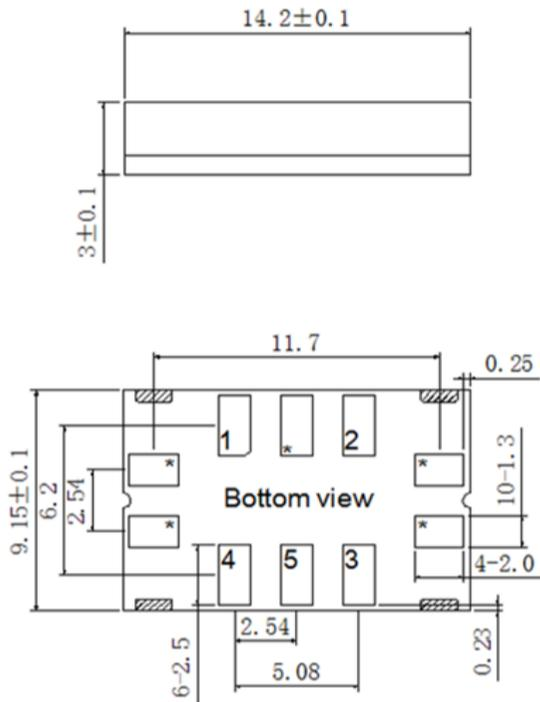

Pin	Function
1	NC (for TCXO) Vc (for VCTCXO)
2	GND
3	Output #1 (F0)
4	Vdd
5	Output #2 (F0/2)
*	For factory test only

Dimensions: mm

REFLOW PROFILE

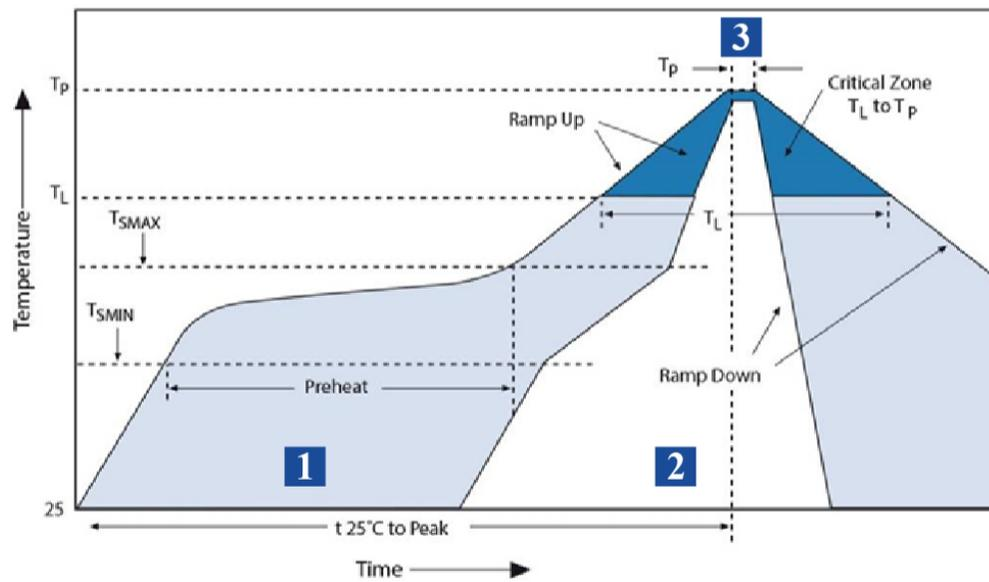

Zone	Description	Temperature	Time
1	Preheat	$T_{SMIN} \sim T_{SMAX}$ 150°C ~ 200°C	60 ~ 120 sec.
2	Reflow	T_L 220°C	60 ~ 150 sec.
3	Peak Heat	T_P 260°C	25 sec. MAX

DUAL OUTPUT STRATUM-III SMD TCXO & VCTCXO

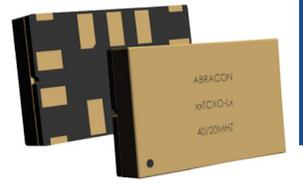

ABDFTCXO/ABDFVCTCXO SERIES

9.0 x 14.0 x 3.0mm

RoHS/RoHS II Compliant

ESD SENSITIVE

MSL = 3

PACKAGING

T5: 500 pcs/reel

T2: 250 pcs/reel

MSL - 3 compliant packaging applies to MOQ=25 units (cut tape) & T5 and T2 options

MSL - 3 compliant packaging DOES NOT apply to bulk quantities

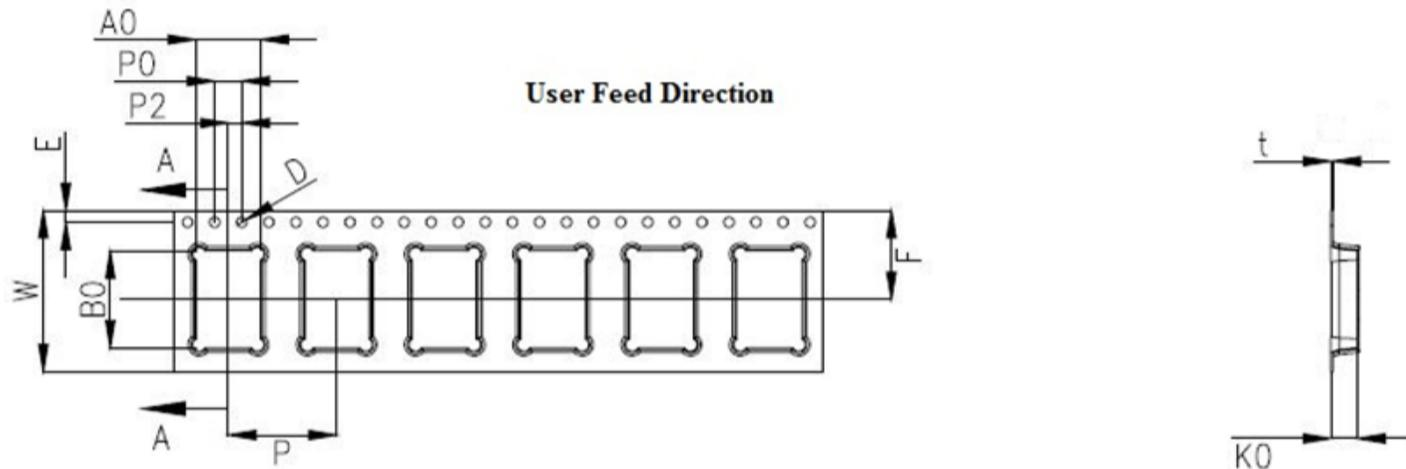

W	A0	B0	K0	P	
24.0±0.3	9.6±0.10	14.5±0.10	3.9±0.10	16.0±0.1	
F	E	D	P0	P2	T
13.25±0.1	1.75±0.1	1.5±0.1	4.0±0.1	2.0±0.1	0.3±0.05

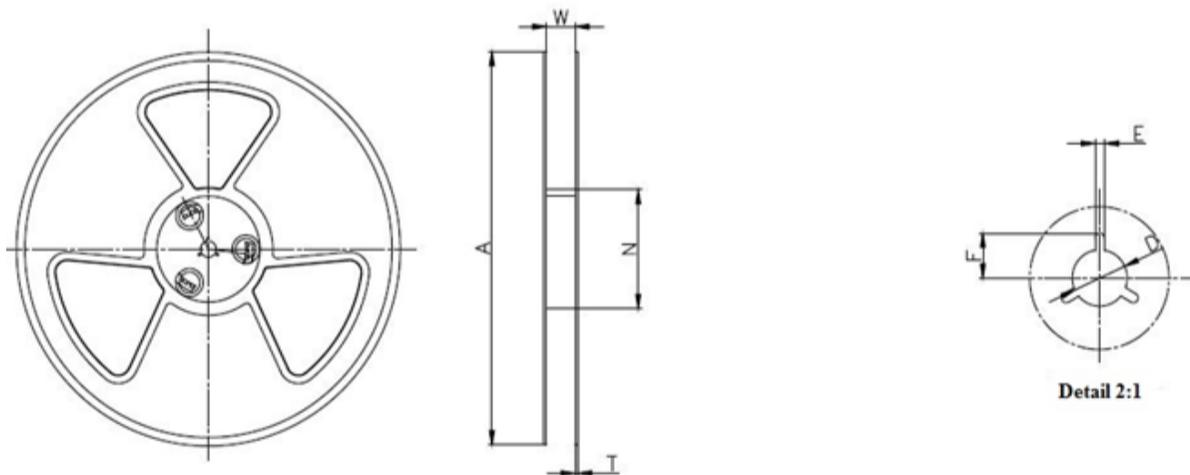

W	A	N	T	E	F	D
24.5±0.4	330±0.5	100±0.3	1.8±0.2	2.1±0.3	10.75±0.3	13.5+0.5/-0.2

Dimensions: mm

Mouser Electronics

Authorized Distributor

Click to View Pricing, Inventory, Delivery & Lifecycle Information:

ABRACON:

[ABDFTCXO-26.000MHz-L-2-CT](#) [ABDFTCXO-16.384MHz-E-2-T5](#) [ABDFTCXO-20.000MHz-E-2-T2](#) [ABDFTCXO-25.000MHz-L-2-T5](#) [ABDFTCXO-30.720MHz-E-2-T2](#) [ABDFVCTCXO-50.000MHz-L-2-T2](#) [ABDFVCTCXO-26.000MHz-L-2-T5](#) [ABDFVCTCXO-52.000MHz-E-2-CT](#) [ABDFTCXO-19.200MHz-L-2-T5](#) [ABDFVCTCXO-16.000MHz-L-2-T2](#) [ABDFVCTCXO-26.000MHz-E-2-T2](#) [ABDFTCXO-40.000MHz-L-2-CT](#) [ABDFTCXO-52.000MHz-E-2-T5](#) [ABDFVCTCXO-24.576MHz-E-2-T2](#) [ABDFTCXO-19.440MHz-L-2-CT](#) [ABDFVCTCXO-16.000MHz-L-2-T5](#) [ABDFVCTCXO-38.400MHz-L-2-T2](#) [ABDFTCXO-10.000MHz-E-2-T2](#) [ABDFVCTCXO-52.000MHz-E-2-T2](#) [ABDFVCTCXO-10.000MHz-L-2-CT](#) [ABDFVCTCXO-50.000MHz-E-2-T2](#) [ABDFTCXO-19.200MHz-E-2-T2](#) [ABDFTCXO-38.880MHz-E-2-T2](#) [ABDFTCXO-10.000MHz-E-2-T5](#) [ABDFTCXO-38.880MHz-L-2-CT](#) [ABDFTCXO-50.000MHz-L-2-T2](#) [ABDFTCXO-19.200MHz-L-2-CT](#) [ABDFTCXO-50.000MHz-E-2-CT](#) [ABDFVCTCXO-16.000MHz-E-2-T5](#) [ABDFVCTCXO-16.384MHz-E-2-T2](#) [ABDFTCXO-30.000MHz-L-2-T2](#) [ABDFTCXO-26.000MHz-L-2-T5](#) [ABDFVCTCXO-38.400MHz-E-2-T5](#) [ABDFTCXO-30.000MHz-L-2-T5](#) [ABDFVCTCXO-40.000MHz-E-2-CT](#) [ABDFTCXO-19.200MHz-L-2-T2](#) [ABDFVCTCXO-25.000MHz-L-2-T2](#) [ABDFVCTCXO-16.000MHz-E-2-CT](#) [ABDFTCXO-12.800MHz-L-2-T5](#) [ABDFVCTCXO-16.384MHz-E-2-CT](#) [ABDFVCTCXO-52.000MHz-L-2-T5](#) [ABDFVCTCXO-20.000MHz-L-2-T5](#) [ABDFTCXO-38.880MHz-E-2-CT](#) [ABDFTCXO-24.576MHz-E-2-T5](#) [ABDFVCTCXO-25.000MHz-L-2-CT](#) [ABDFTCXO-20.000MHz-E-2-CT](#) [ABDFTCXO-25.000MHz-L-2-T2](#) [ABDFTCXO-19.200MHz-E-2-T5](#) [ABDFVCTCXO-40.000MHz-L-2-T5](#) [ABDFTCXO-19.440MHz-L-2-T2](#) [ABDFTCXO-30.720MHz-L-2-CT](#) [ABDFVCTCXO-10.000MHz-E-2-T2](#) [ABDFTCXO-19.440MHz-E-2-T5](#) [ABDFVCTCXO-24.576MHz-L-2-T5](#) [ABDFTCXO-10.000MHz-L-2-T2](#) [ABDFVCTCXO-30.720MHz-E-2-T2](#) [ABDFTCXO-25.000MHz-E-2-T5](#) [ABDFTCXO-40.000MHz-E-2-CT](#) [ABDFVCTCXO-12.800MHz-E-2-T5](#) [ABDFVCTCXO-24.576MHz-L-2-T2](#) [ABDFVCTCXO-50.000MHz-E-2-T5](#) [ABDFTCXO-38.400MHz-E-2-CT](#) [ABDFVCTCXO-40.000MHz-E-2-T2](#) [ABDFTCXO-26.000MHz-L-2-T2](#) [ABDFVCTCXO-26.000MHz-E-2-T5](#) [ABDFVCTCXO-50.000MHz-E-2-CT](#) [ABDFVCTCXO-38.880MHz-L-2-T5](#) [ABDFVCTCXO-30.000MHz-L-2-T5](#) [ABDFTCXO-40.000MHz-L-2-T5](#) [ABDFVCTCXO-38.400MHz-E-2-T2](#) [ABDFVCTCXO-30.000MHz-L-2-T2](#) [ABDFVCTCXO-12.800MHz-L-2-T2](#) [ABDFTCXO-19.440MHz-E-2-T2](#) [ABDFTCXO-24.576MHz-E-2-T2](#) [ABDFTCXO-52.000MHz-L-2-T5](#) [ABDFTCXO-52.000MHz-E-2-CT](#) [ABDFTCXO-30.720MHz-E-2-T5](#) [ABDFTCXO-12.800MHz-E-2-T2](#) [ABDFTCXO-19.440MHz-L-2-T5](#) [ABDFTCXO-38.400MHz-E-2-T5](#) [ABDFVCTCXO-16.384MHz-L-2-T2](#) [ABDFVCTCXO-16.000MHz-L-2-CT](#) [ABDFVCTCXO-40.000MHz-L-2-T2](#) [ABDFVCTCXO-52.000MHz-L-2-T2](#) [ABDFTCXO-12.800MHz-E-2-T5](#) [ABDFTCXO-52.000MHz-E-2-T2](#) [ABDFTCXO-24.576MHz-L-2-CT](#) [ABDFTCXO-38.880MHz-E-2-T5](#) [ABDFVCTCXO-19.440MHz-E-2-CT](#) [ABDFVCTCXO-19.440MHz-L-2-T2](#) [ABDFVCTCXO-10.000MHz-E-2-CT](#) [ABDFVCTCXO-38.400MHz-L-2-T5](#) [ABDFVCTCXO-26.000MHz-E-2-CT](#) [ABDFVCTCXO-10.000MHz-L-2-T2](#) [ABDFVCTCXO-19.200MHz-L-2-CT](#) [ABDFTCXO-30.720MHz-E-2-CT](#)

Компания «Life Electronics» занимается поставками электронных компонентов импортного и отечественного производства от производителей и со складов крупных дистрибьюторов Европы, Америки и Азии.

С конца 2013 года компания активно расширяет линейку поставок компонентов по направлению коаксиальный кабель, кварцевые генераторы и конденсаторы (керамические, пленочные, электролитические), за счёт заключения дистрибьюторских договоров

Мы предлагаем:

- Конкуренспособные цены и скидки постоянным клиентам.
- Специальные условия для постоянных клиентов.
- Подбор аналогов.
- Поставку компонентов в любых объемах, удовлетворяющих вашим потребностям.
- Приемлемые сроки поставки, возможна ускоренная поставка.
- Доставку товара в любую точку России и стран СНГ.
- Комплексную поставку.
- Работу по проектам и поставку образцов.
- Формирование склада под заказчика.
- Сертификаты соответствия на поставляемую продукцию (по желанию клиента).
- Тестирование поставляемой продукции.
- Поставку компонентов, требующих военную и космическую приемку.
- Входной контроль качества.
- Наличие сертификата ISO.

В составе нашей компании организован Конструкторский отдел, призванный помогать разработчикам, и инженерам.

Конструкторский отдел помогает осуществить:

- Регистрацию проекта у производителя компонентов.
- Техническую поддержку проекта.
- Защиту от снятия компонента с производства.
- Оценку стоимости проекта по компонентам.
- Изготовление тестовой платы монтаж и пусконаладочные работы.



Тел: +7 (812) 336 43 04 (многоканальный)
Email: org@lifeelectronics.ru