

SPDT SWITCH GaAs MMIC

■ GENERAL DESCRIPTION

The NJG1806K75 is a 1bit control SPDT switch IC suited for switching transmit/receive signals at 802.11 a/b/g/n/ac applications.

The NJG1806K75 features low insertion loss, high isolation, and high handling power down to 1.8V control voltage at high frequency up to 6GHz.

This switch has ESD protection devices to achieve excellent ESD performances. And the ultra small and ultra thin package of DFN6-75 is adopted.

■ PACKAGE OUTLINE

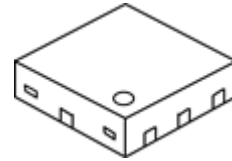

NJG1806K75

■ APPLICATION

- 802.11 a/b/g/n/ac networks applications
- Transmit / receive switching, antenna switching and others switching applications

■ FEATURES

- Low control voltage $V_{CTL(H)}=1.8V$ typ.
- Voltage operation $V_{DD}=3.3V$ typ.
- Low insertion loss 0.35dB typ. @f=2.4 to 2.5GHz
- 0.40dB typ. @f=4.9 to 5.9GHz
- High isolation 25dB typ. @f=2.4 to 2.5GHz
- 25dB typ. @f=4.9 to 5.9GHz
- P-1dB $P_{-1dB}=31$ dBm typ. @f=2.5GHz
- $P_{-1dB}=31$ dBm typ. @f=5.9GHz
- Ultra small & ultra thin package DFN6-75 (Package Size: 1.0x1.0x0.375mm typ.)
- RoHS compliant and Halogen Free, MSL1

■ PIN CONFIGURATION

(Top view)

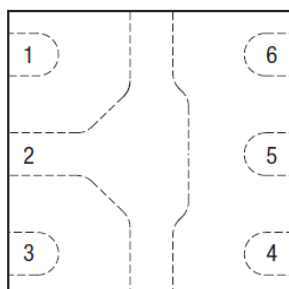

Pin connection

1. P1
2. GND
3. P2
4. VCTL
5. PC
6. VDD

■ TRUTH TABLE

“H”= $V_{CTL(H)}$, “L”= $V_{CTL(L)}$

ON PATH	VCTL
PC-P1	H
PC-P2	L

NOTE: Please note that any data or drawing in this catalog is subject to change.

■ ABSOLUTE MAXIMUM RATINGS

$T_a=+25^{\circ}\text{C}$, $Z_s=Z_l=50\Omega$

PARAMETER	SYMBOL	CONDITIONS	RATINGS	UNITS
RF Input Power	P_{IN}	$V_{DD}=3.3\text{V}$, ON State Port	31	dBm
Supply Voltage	V_{DD}		6.0	V
Control Voltage	V_{CTL}		6.0	V
Power Dissipation	P_D	4-layer FR4 PCB without through-hole (76.2x114.3mm), $T_j=150^{\circ}\text{C}$	430	mW
Operating Temperature	T_{opr}		-40 to +105	$^{\circ}\text{C}$
Storage Temperature	T_{stg}		-55 to +150	$^{\circ}\text{C}$

■ ELECTRICAL CHARACTERISTICS1 (DC CHARACTERISTICS)

(General conditions: $T_a=+25^{\circ}\text{C}$, with application circuit)

PARAMETERS	SYMBOL	CONDITIONS	MIN	TYP	MAX	UNITS
Supply Voltage	V_{DD}		2.5	3.3	5.0	V
Operating Current	I_{DD}	No RF input, $V_{DD}=3.3\text{V}$	-	15	30	μA
Control Voltage (HIGH)	$V_{CTL(H)}$		1.35	1.8	5.0	V
Control Voltage (LOW)	$V_{CTL(L)}$		0	-	0.45	V
Control Current	I_{CTL}	$V_{CTL(H)}=1.8\text{V}$	-	3	10	μA

■ ELECTRICAL CHARACTERISTICS2 (RF CHARACTERISTICS)

(General conditions: $V_{DD}=3.3V$, $V_{CTL(H)}=1.8V$, $V_{CTL(L)}=0V$, $T_a=+25^{\circ}C$, $Z_S=Z_I=50\Omega$, with application circuit)

PARAMETERS	SYMBOL	CONDITIONS	MIN	TYP	MAX	UNITS
Insertion loss1	LOSS1	f=2.4 to 2.5GHz	-	0.35	0.55	dB
Insertion loss2	LOSS2	f=4.9 to 5.9GHz	-	0.40	0.60	dB
Isolation1	ISL1	f=2.4 to 2.5GHz	23	25	-	dB
Isolation2	ISL2	f=4.9 to 5.9GHz	23	25	-	dB
Return loss1	RL1	f=2.4 to 2.5GHz	18	28	-	dB
Return loss2	RL2	f=4.9 to 5.9GHz	15	20	-	dB
Input power at 1dB compression point1	P_{-1dB1}	f=2.4 to 2.5GHz	29	31	-	dBm
Input power at 1dB compression point2	P_{-1dB2}	f=4.9 to 5.9GHz	28	31	-	dBm
Switching time	T_{SW}	50% V_{CTL} to 10%/90% RF	-	150	300	ns

■ TERMINAL INFORMATION

No.	SYMBOL	DESCRIPTION
1	P1	RF terminal. An external DC blocking capacitor is required.
2	GND	Ground terminal. Please connect this terminal with ground plane as close as possible for excellent RF performance.
3	P2	RF terminal. An external DC blocking capacitor is required.
4	VCTL	Control voltage input terminal. This terminal is set to High-Level (+1.35 to +5.0V) or Low-Level (0 to +0.45V).
5	PC	Common RF terminal. An external DC blocking capacitor is required.
6	VDD	Positive voltage supply terminal. The positive voltage (+2.5 to +5.0V) has to be supplied. Please connect a bypass capacitor with GND terminal for excellent RF performance.

■ ELECTRICAL CHARACTERISTICS

Loss, ISL vs Frequency

(PC-P1 ON, $V_{DD}=3.3V$, $V_{CTL}=1.8V$)

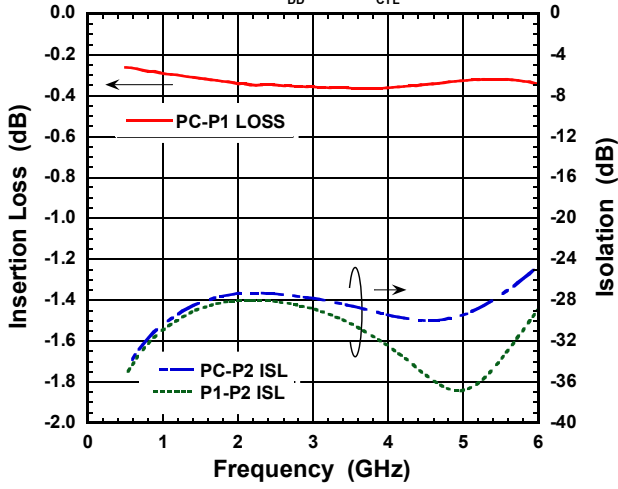

Loss, ISL vs Frequency

(PC-P2 ON, $V_{DD}=3.3V$, $V_{CTL}=0V$)

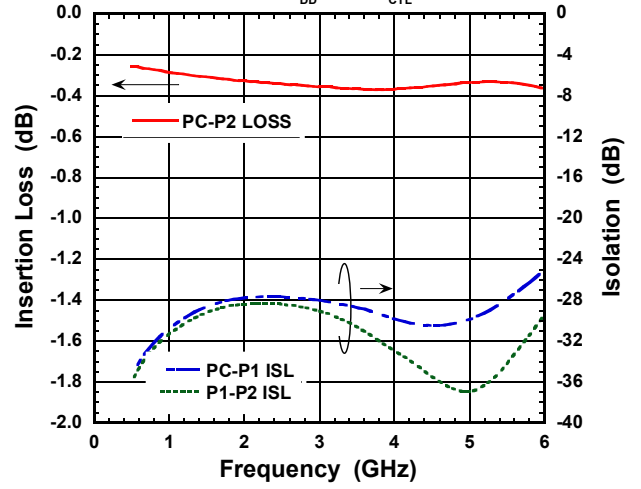

Return Loss vs Frequency

(PC-P1 ON, $V_{DD}=3.3V$, $V_{CTL}=1.8V$)

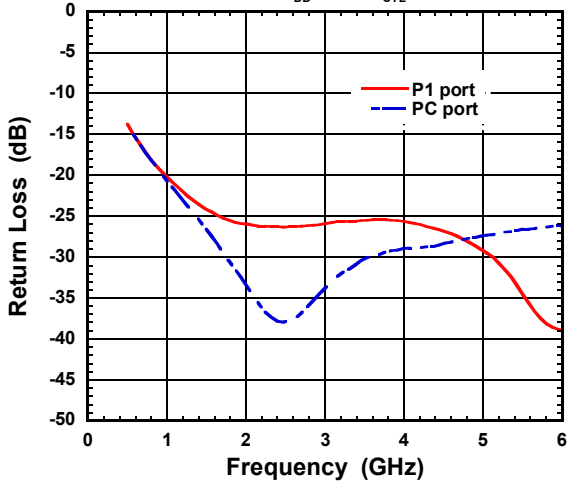

Return Loss vs Frequency

(PC-P2 ON, $V_{DD}=3.3V$, $V_{CTL}=0V$)

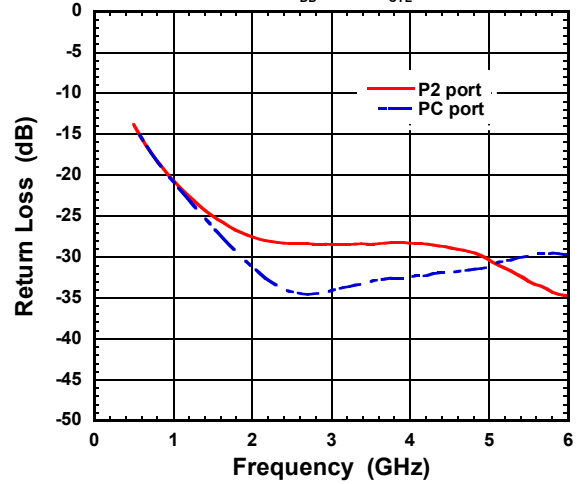

Switching Time

(PC-P1 path, $V_{DD}=3.3V$, $V_{CTL(H)}=1.8V$)

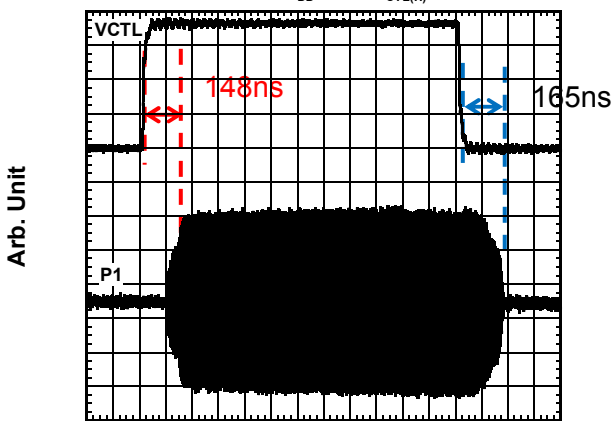

Time (100ns/div)

■ ELECTRICAL CHARACTERISTICS

Output Power, I_{DD} vs Input Power

(PC-P1 ON, $V_{CTL}=1.8V$, $f=2.5GHz$)

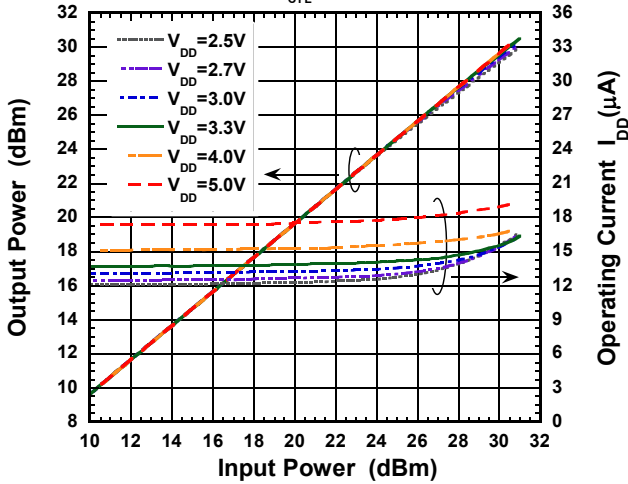

Output Power, I_{DD} vs Input Power

(PC-P2 ON, $V_{CTL}=0V$, $f=2.5GHz$)

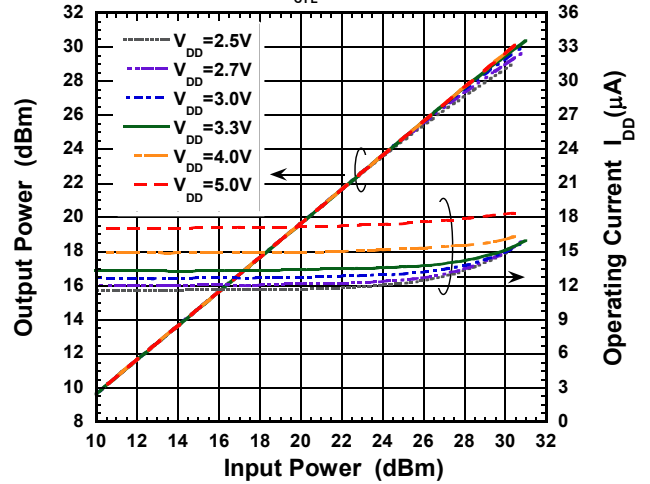

Loss, ISL vs Input Power

(PC-P1 ON, $V_{CTL}=1.8V$, $f=2.5GHz$)

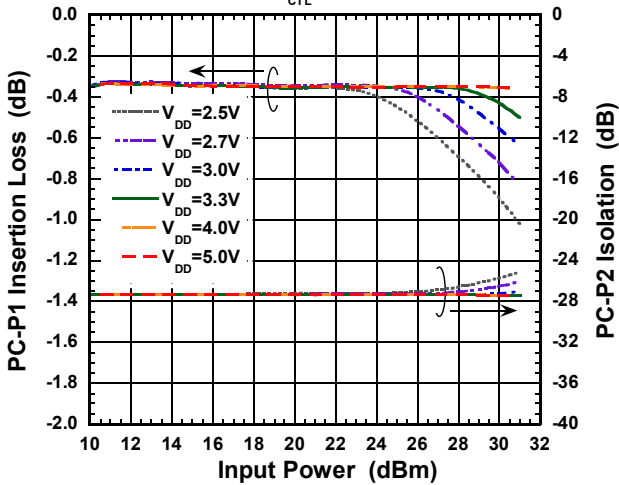

Loss, ISL vs Input Power

(PC-P2 ON, $V_{CTL}=0V$, $f=2.5GHz$)

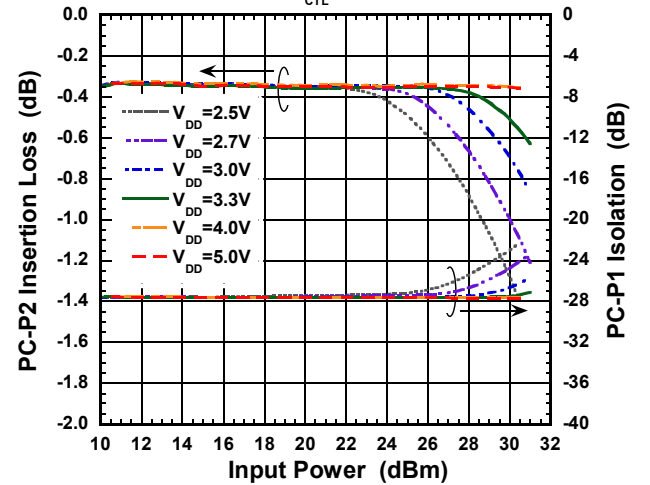

Output Power, I_{DD} vs Input Power

(PC-P1 ON, $V_{CTL}=1.8V$, $f=5.9GHz$)

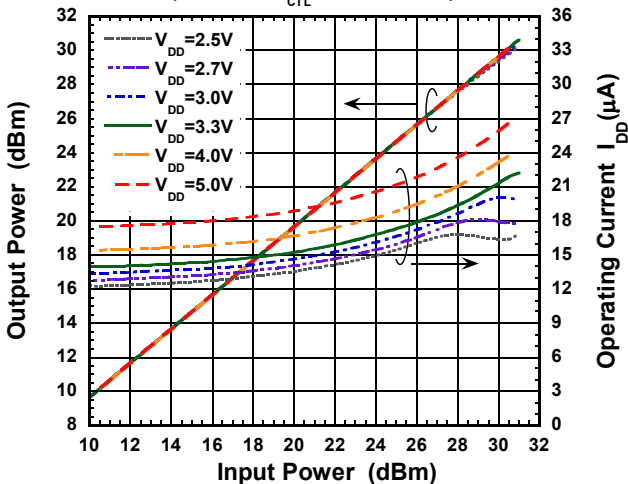

Output Power, I_{DD} vs Input Power

(PC-P2 ON, $V_{CTL}=0V$, $f=5.9GHz$)

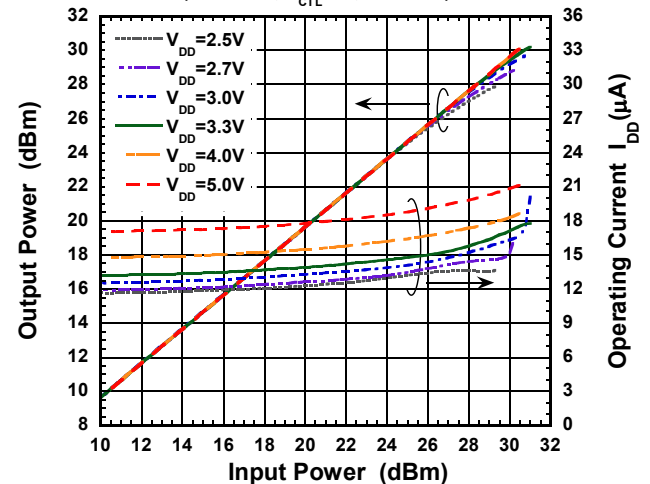

■ ELECTRICAL CHARACTERISTICS

Loss, ISL vs Input Power

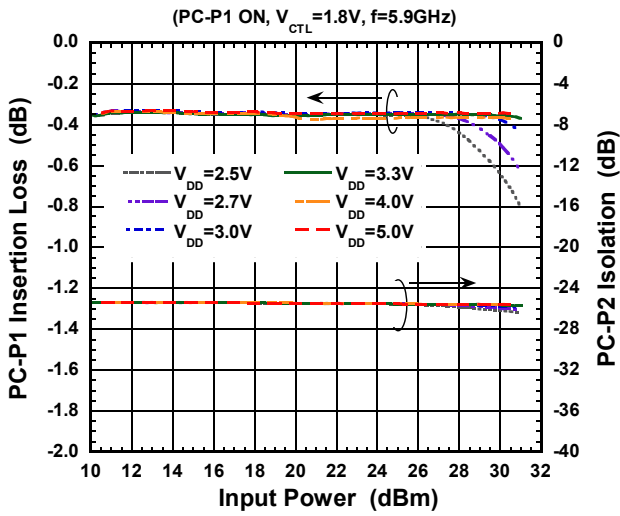

Loss, ISL vs Input Power

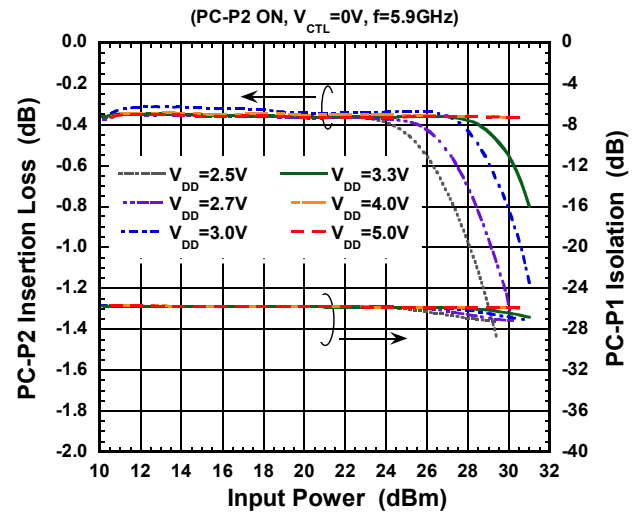

EVM vs Input Power

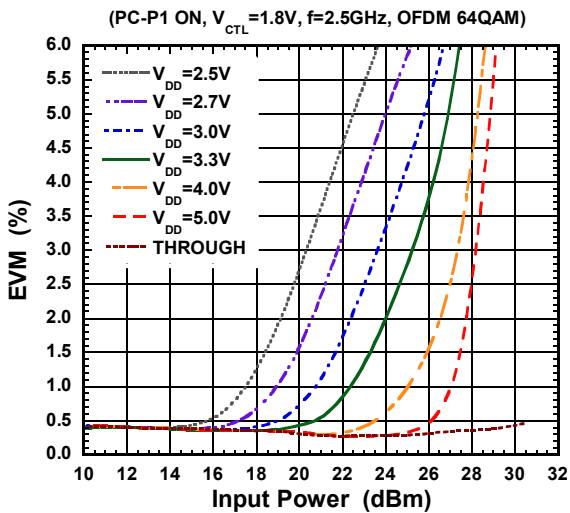

EVM vs Input Power

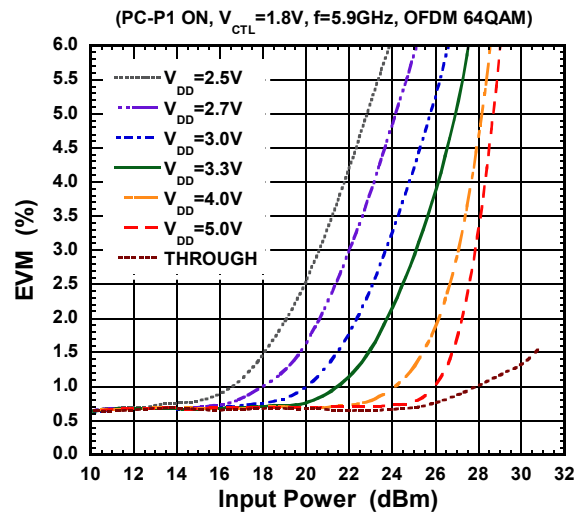

■ ELECTRICAL CHARACTERISTICS

Loss, ISL vs Temperature

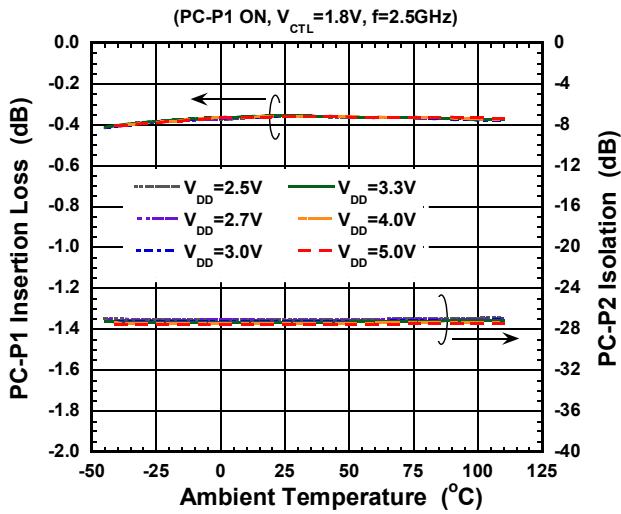

Loss, ISL vs Temperature

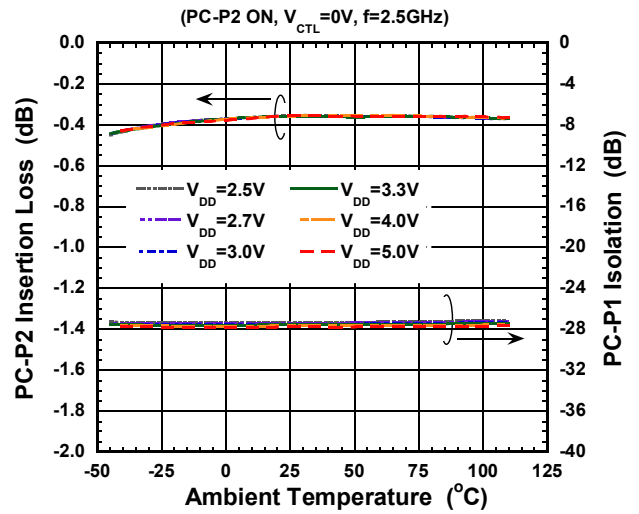

Loss, ISL vs Temperature

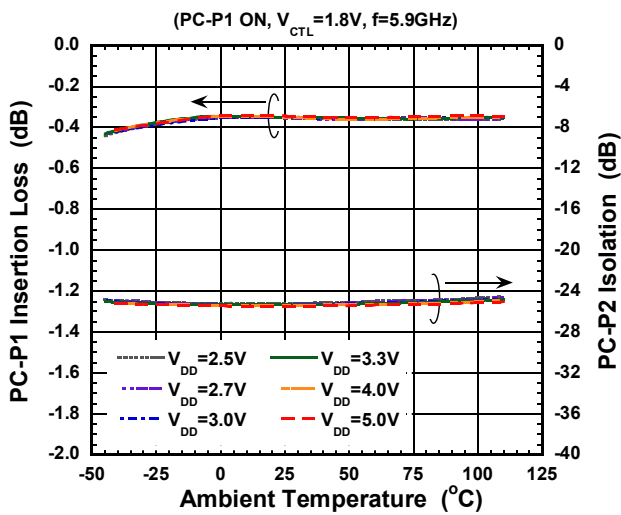

Loss, ISL vs Temperature

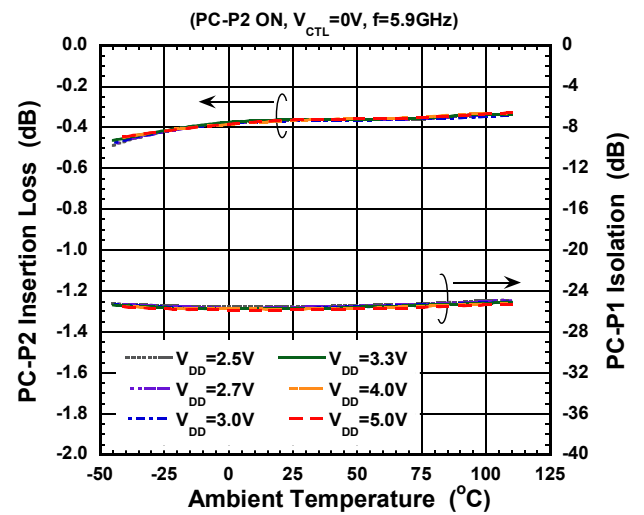

P_{-1dB} vs Temperature

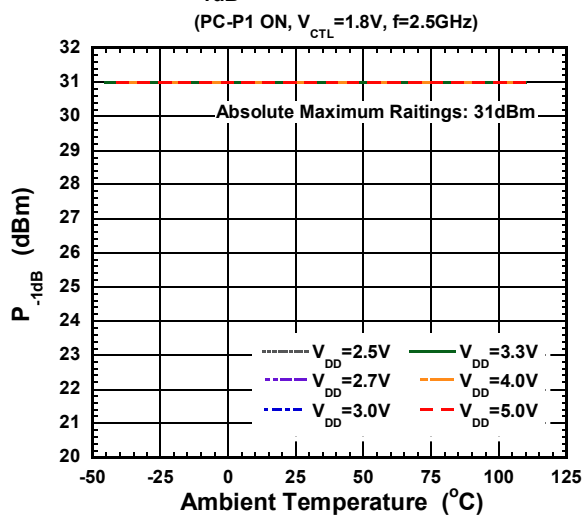

P_{-1dB} vs Temperature

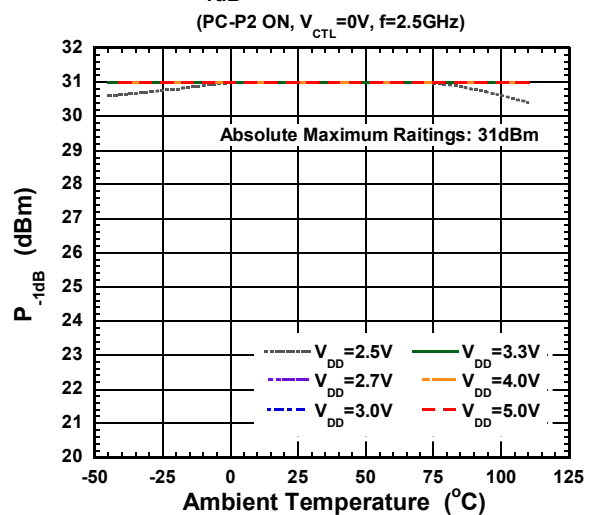

■ ELECTRICAL CHARACTERISTICS

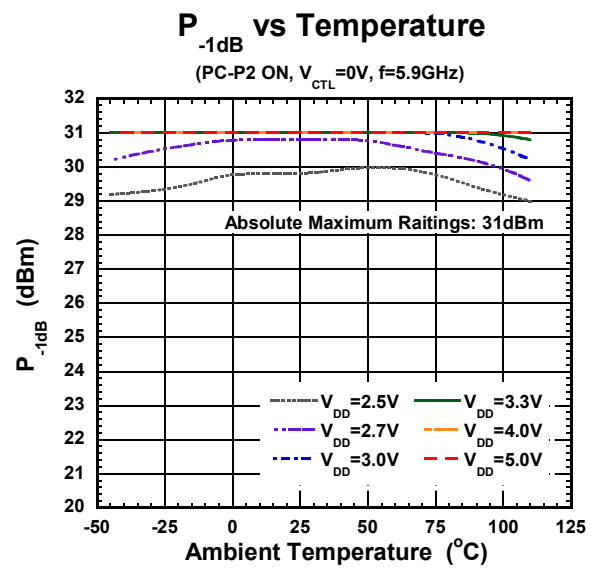
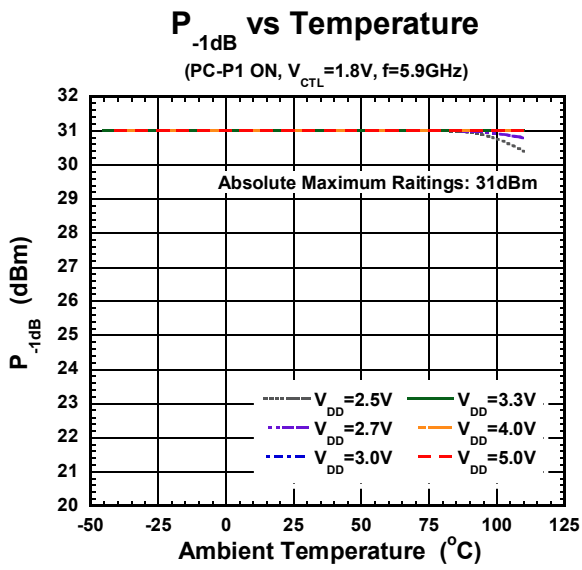

APPLICATION CIRCUIT

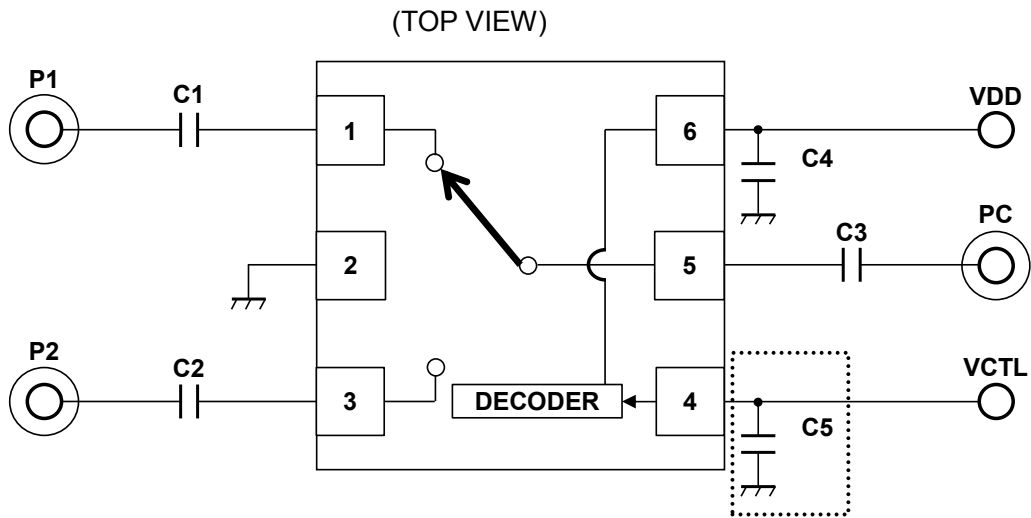

NOTE:

The bypass capacitor, C5 is optional, and is recommended only when the control line is affected under noisy environment.

RECOMMENDED PCB DESIGN

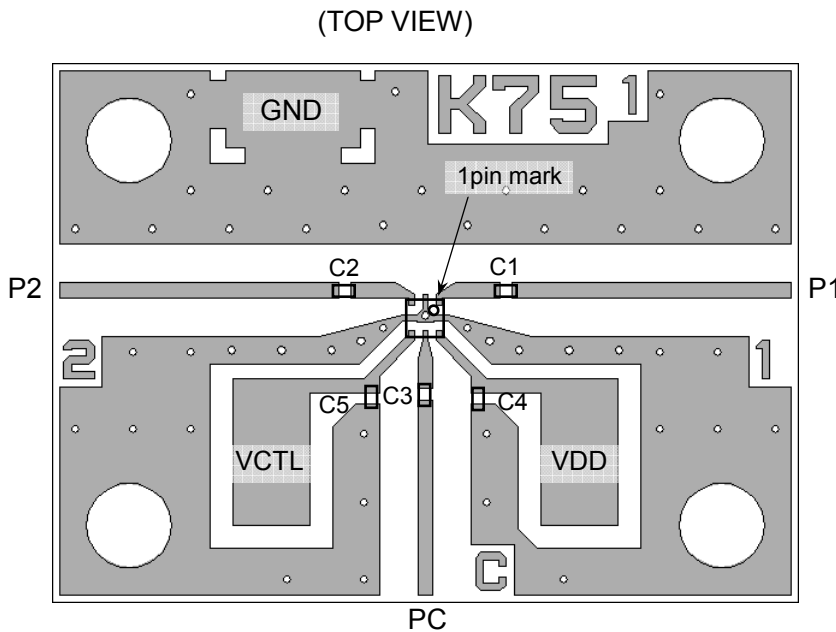

PCB: FR-4, t=0.2mm
 Capacitor Size: 0603 (0.6 x 0.3 mm)
 Strip Line Width: 0.4mm
 PCB Size: 19.4 x 14.0mm
 Through Hole Diameter: 0.2mm

Loss of PCB, capacitor and connectors

Frequency (GHz)	Loss (dB)
2.4	0.30
2.5	0.31
4.9	0.59
5.9	0.71

PARTS LIST

No.	Value	Notes
C1 to C3	27pF	Murata MFG (GRM03 series)
C4	1000pF	
C5	10pF	

■ PCB LAYOUT GUIDELINE

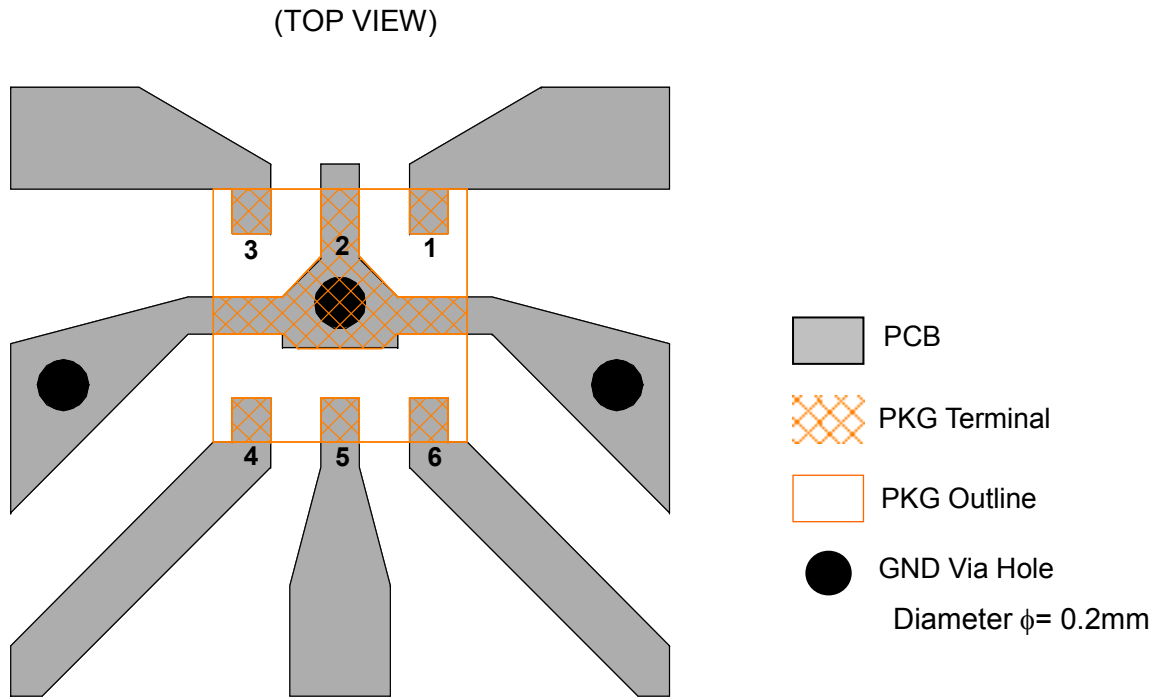

PRECAUTIONS

- [1] The DC blocking capacitors should be placed at RF terminals. Please choose appropriate capacitance value at the application frequency.
- [2] For good RF performance, exposed pad should be connected to PCB ground plane as close as possible.

■ PACKAGE OUTLINE (DFN6-75)

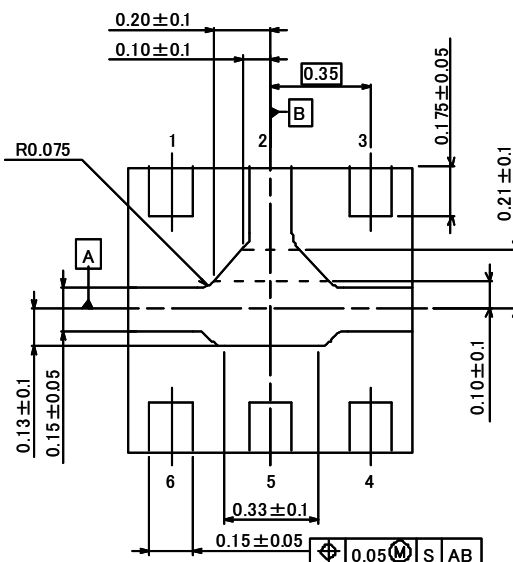
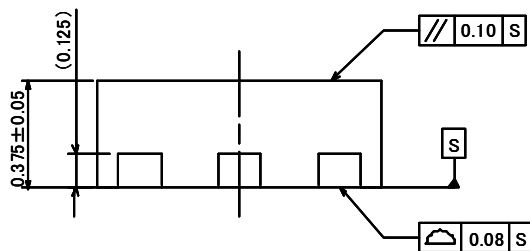
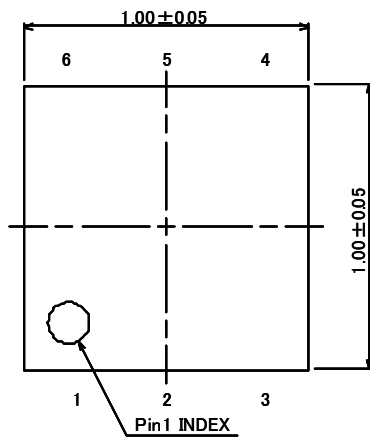

Unit	: mm
Board	: Cu
Terminal Treat	: Ni/Pd/Au
Molding Material	: Epoxy resin
Weight	: 1.2mg

Cautions on using this product

- This product contains Gallium-Arsenide (GaAs) which is a harmful material.
- Do NOT eat or put into mouth.
- Do NOT dispose in fire or break up this product.
- Do NOT chemically make gas or powder with this product.
- To waste this product, please obey the relating law of your country.

[CAUTION]

The specifications on this databook are only given for information, without any guarantee as regards either mistakes or omissions. The application circuits in this databook are described only to show representative usages of the product and not intended for the guarantee or permission of any right including the industrial rights.

This product may be damaged with electric static discharge (ESD) or spike voltage. Please handle with care to avoid these damages.

Mouser Electronics

Authorized Distributor

Click to View Pricing, Inventory, Delivery & Lifecycle Information:

[NJR:](#)

[NJG1806K75-TE1](#)

Компания «Life Electronics» занимается поставками электронных компонентов импортного и отечественного производства от производителей и со складов крупных дистрибьюторов Европы, Америки и Азии.

С конца 2013 года компания активно расширяет линейку поставок компонентов по направлению коаксиальный кабель, кварцевые генераторы и конденсаторы (керамические, пленочные, электролитические), за счёт заключения дистрибьюторских договоров

Мы предлагаем:

- Конкурентоспособные цены и скидки постоянным клиентам.
- Специальные условия для постоянных клиентов.
- Подбор аналогов.
- Поставку компонентов в любых объемах, удовлетворяющих вашим потребностям.
- Приемлемые сроки поставки, возможна ускоренная поставка.
- Доставку товара в любую точку России и стран СНГ.
- Комплексную поставку.
- Работу по проектам и поставку образцов.
- Формирование склада под заказчика.
- Сертификаты соответствия на поставляемую продукцию (по желанию клиента).
- Тестирование поставляемой продукции.
- Поставку компонентов, требующих военную и космическую приемку.
- Входной контроль качества.
- Наличие сертификата ISO.

В составе нашей компании организован Конструкторский отдел, призванный помогать разработчикам, и инженерам.

Конструкторский отдел помогает осуществить:

- Регистрацию проекта у производителя компонентов.
- Техническую поддержку проекта.
- Защиту от снятия компонента с производства.
- Оценку стоимости проекта по компонентам.
- Изготовление тестовой платы монтаж и пусконаладочные работы.



Тел: +7 (812) 336 43 04 (многоканальный)
Email: org@lifeelectronics.ru