

DATA SHEET

ARRAY CHIP RESISTORS

YC/TC

5%, 1%

sizes

YC: 102/104/122/124/162/164/248/324/158T/358L/358T

TC: 122/124/164

RoHS compliant



PHYCOMP BRAND ordering codes

Both GLOBAL PART NUMBER (preferred) and I2NC (traditional) codes are acceptable to order Phycomp brand products.

GLOBAL PART NUMBER (PREFERRED)

For detailed information of GLOBAL PART NUMBER and ordering example, please refer to page 2. TC122 series is supplied and ordered by global part number only.

I2NC CODE

| TYPE/ 2×0402 | 2350 | XXX XXXXX L | | | | PAPER / PE TAPE ON REEL (units) ⁽²⁾ | |
|-----------------|------|-------------|------------|-----|-----------|--|--|
| | (1) | (2) | (3) | (4) | 10,000 | 50,000 | |
| ARV321 | 2350 | ±5% | 1 to 1 MΩ | | 013 11xxx | 013 12xxx | |
| ARV322 | 2350 | ±1% | 10 to 1 MΩ | | 013 2xxxx | 013 3xxxx | |
| Jumper | 2350 | - | 0 Ω | | 013 91001 | - | |

| Last digit of I2NC Resistance decade ⁽³⁾ | Last digit |
|--|------------|
| 0.01 to 0.0976 Ω | 0 |
| 0.1 to 0.976 Ω | 7 |
| 1 to 9.76 Ω | 8 |
| 10 to 97.6 Ω | 9 |
| 100 to 976 Ω | 1 |
| 1 to 9.76 KΩ | 2 |
| 10 to 97.6 KΩ | 3 |
| 100 to 976 KΩ | 4 |
| 1 to 9.76 MΩ | 5 |
| 10 to 97.6 MΩ | 6 |

- (1) The resistors have a 12-digit ordering code starting with 2350.
- (2) The subsequent 4 or 5 digits indicate the resistor tolerance and packaging.
- (3) The remaining 4 or 3 digits represent the resistance value with the last digit indicating the multiplier as shown in the table of "Last digit of I2NC".
- (4) "L" is optional symbol ^(Note).

Example:

| | | |
|--------|---|-------------|
| 0.02 Ω | = | 0200 or 200 |
| 0.3 Ω | = | 3007 or 307 |
| 1 Ω | = | 1008 or 108 |
| 33 KΩ | = | 3303 or 333 |
| 10 MΩ | = | 1006 or 106 |

ORDERING EXAMPLE

The ordering code of a ARV321 resistor, value 1,000Ω with ±5% tolerance, supplied in tape of 10,000 units per reel is: 235001311102(L) or YC122-JR-071KL.

NOTE

- 1. All our RSMD products are RoHS compliant. "LFP" of the internal 2D reel label mentions "Lead Free Process"
- 2. On customized label, "LFP" or specific symbol printed and the optional "L" at the end of GLOBAL PART NUMBER / I2NC can be added (both are on customer request)

MARKING

YCI02

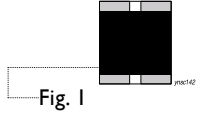

No marking

YCI22

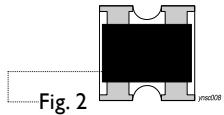

No marking

YCI04

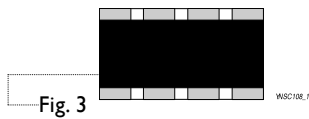

No marking

YCI24 / 162 / 164 / 324

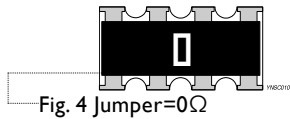

I-Digit marking

Fig. 4 Jumper=0Ω

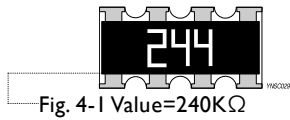

E-24 series: 3 digits, 5%
First two digits for significant figure and 3rd digit for number of zeros

Fig. 4-1 Value=240KΩ

YC248

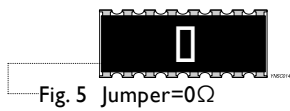

I-Digit marking

Fig. 5 Jumper=0Ω

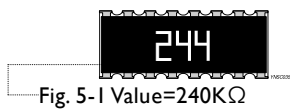

E-24 series: 3 digits, 5%
First two digits for significant figure and 3rd digit for number of zeros

Fig. 5-1 Value=240KΩ

YCI58T/358L/358T

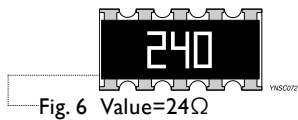

Fig. 6 Value=24Ω

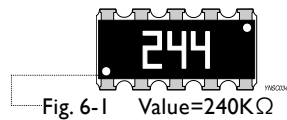
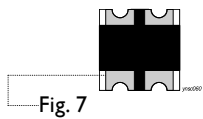

Fig. 6-1 Value=240KΩ

E-24 series: 3 digits
First two digits for significant figure and 3rd digit for number of zeros

TCI22



No marking

Fig. 7

TCI24

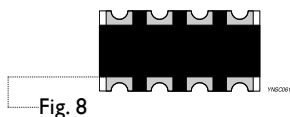

No marking

Fig. 8

TCI64



I-Digit marking

Fig. 9 Jumper=0Ω



E-24 series: 3 digits, 5%

First two digits for significant figure and 3rd digit for number of zeros

Fig. 9-1 Value=240KΩ

For further marking information, please refer to data sheet “Chip resistors marking”.

CONSTRUCTION

The resistor is constructed on top of a high-grade ceramic body. Internal metal electrodes are added on each end to make the contacts to the thick film resistive element. The composition of the resistive element is a noble metal imbedded into a glass and covered by a second glass to prevent environment influences. The resistor is laser trimmed to the rated resistance value. The resistor is covered with a protective epoxy coat, finally the two external terminations (matte tin on Ni-barrier) are added as shown in Fig.9.

OUTLINES

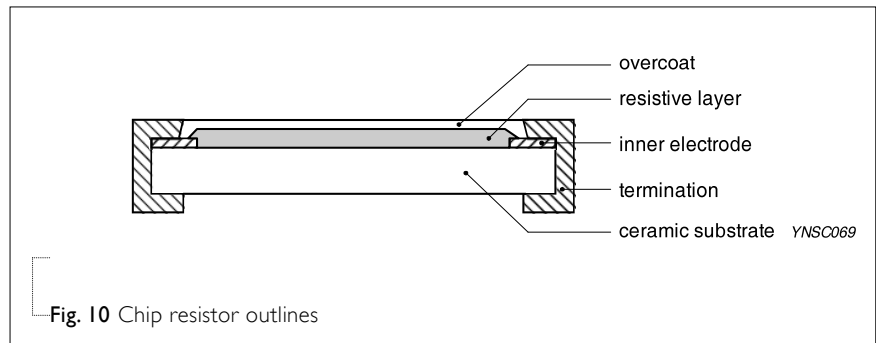

SCHEMATIC



DIMENSIONS

Table I

| TYPE | H / H _I / H _W | B | P | L | T | W1 | W2 |
|--------|--|-------------|-------------|-------------|-------------|-------------|-------------|
| YCI02 | H: 0.25 ± 0.10 | 0.15 ± 0.10 | 0.55 ± 0.10 | 0.80 ± 0.10 | 0.35 ± 0.10 | 0.15 ± 0.10 | 0.60 ± 0.10 |
| YCI04 | H: 0.20 ± 0.10 | 0.15 ± 0.05 | 0.40 ± 0.10 | 1.40 ± 0.10 | 0.35 ± 0.10 | 0.15 ± 0.10 | 0.60 ± 0.10 |
| YCI22 | H: 0.21+0.10 / -0.05 H _W : 0.35 ± 0.10 | 0.20 ± 0.10 | 0.67 ± 0.05 | 1.00 ± 0.10 | 0.30 ± 0.10 | 0.25 ± 0.10 | 1.00 ± 0.10 |
| YCI24 | H: 0.45 ± 0.05 H _I : 0.30 ± 0.05 | 0.20 ± 0.15 | 0.50 ± 0.05 | 2.00 ± 0.10 | 0.45 ± 0.10 | 0.30 ± 0.15 | 1.00 ± 0.10 |
| YCI62 | H: 0.30 ± 0.10 H _W : 0.65 ± 0.15 | 0.30 ± 0.10 | 0.80 ± 0.05 | 1.60 ± 0.10 | 0.40 ± 0.10 | 0.30 ± 0.10 | 1.60 ± 0.10 |
| YCI64 | H: 0.65 ± 0.05 H _I : 0.50 ± 0.15 | 0.30 ± 0.15 | 0.80 ± 0.05 | 3.20 ± 0.15 | 0.60 ± 0.10 | 0.30 ± 0.15 | 1.60 ± 0.15 |
| YC248 | H: 0.45 ± 0.05 H _I : 0.30 ± 0.05 | 0.30 ± 0.15 | 0.50 ± 0.05 | 4.00 ± 0.20 | 0.45 ± 0.10 | 0.40 ± 0.15 | 1.60 ± 0.15 |
| YC324 | H: 1.10 ± 0.15 H _I : 0.90 ± 0.15 | 0.50 ± 0.20 | 1.27 ± 0.05 | 5.08 ± 0.20 | 0.60 ± 0.10 | 0.50 ± 0.15 | 3.20 ± 0.20 |
| TCI22 | H: 0.30 ± 0.05 | 0.25 ± 0.15 | 0.50 ± 0.05 | 1.00 ± 0.10 | 0.30 ± 0.10 | 0.25 ± 0.15 | 1.00 ± 0.10 |
| TCI24 | H: 0.30 ± 0.10 | 0.20 ± 0.10 | 0.50 ± 0.05 | 2.00 ± 0.10 | 0.40 ± 0.10 | 0.25 ± 0.10 | 1.00 ± 0.10 |
| TCI64 | H: 0.50 ± 0.15 | 0.30 ± 0.15 | 0.80 ± 0.05 | 3.20 ± 0.15 | 0.60 ± 0.10 | 0.30 ± 0.15 | 1.60 ± 0.15 |
| YCI58T | H: 0.45 ± 0.05 H _I : 0.32 ± 0.05 | 0.30 ± 0.15 | 0.64 ± 0.05 | 3.20 ± 0.20 | 0.60 ± 0.10 | 0.35 ± 0.15 | 1.60 ± 0.15 |
| YC358L | H: 1.10 ± 0.15 | 0.50 ± 0.15 | 1.27 ± 0.05 | 6.40 ± 0.20 | 0.60 ± 0.10 | 0.50 ± 0.15 | 3.20 ± 0.20 |
| YC358T | H _I : 0.90 ± 0.15 | | | | | | |

ELECTRICAL CHARACTERISTICS

Table 2

| TYPE | POWER P ₇₀ | OPERATING TEMP. RANGE | MWV | RCOV | DWV | RESISTANCE RANGE & TOLERANCE | T. C. R. | Jumper criteria (unit: A) |
|------------------|--------------------------|--------------------------|-------|------|------|--|---|--|
| YC102 | 1/32W | -55°C to +125°C | 15V | 30V | 30V | E24 ±5% 10Ω ≤ R ≤ 1MΩ E24/E96 ±1% 10Ω ≤ R ≤ 1MΩ Jumper < 0.05Ω | ±200 ppm/°C | Rated current 0.5 Max. current 1.0 |
| YC104 | 1/32W | -55°C to +125°C | 12.5V | 25V | 25V | E24 ±5% 10Ω ≤ R ≤ 1MΩ E24/E96 ±1% 10Ω ≤ R ≤ 1MΩ Jumper < 0.05Ω | | Rated current 0.5 Max. current 1.0 |
| YC122 | 1/16W | -55°C to +155°C | 50V | 100V | 100V | E24 ±5% 1Ω ≤ R ≤ 1MΩ E24/E96 ±1% 1Ω ≤ R ≤ 1MΩ Jumper < 0.05Ω | 1Ω ≤ R ≤ 10Ω ±250 ppm/°C 10Ω ≤ R ≤ 1MΩ ±200 ppm/°C | Rated current 0.5 Max. current 1.0 |
| YC124 | 1/16W | -55°C to +155°C | 25V | 50V | 100V | E24 ±5% 1Ω ≤ R ≤ 1MΩ E24/E96 ±1% 1Ω ≤ R ≤ 1MΩ Jumper < 0.05Ω | | Rated current 1.0 Max. current 2.0 |
| YC162 | 1/16W | -55°C to +155°C | 50V | 100V | 100V | E24 ±5% 1Ω ≤ R ≤ 1MΩ E24/E96 ±1% 1Ω ≤ R ≤ 1MΩ Jumper < 0.05Ω | | Rated current 1.0 Max. current 2.0 |
| YC164 | 1/16W | -55°C to +155°C | 50V | 100V | 100V | E24 ±5% 1Ω ≤ R ≤ 1MΩ E24/E96 ±1% 1Ω ≤ R ≤ 1MΩ Jumper < 0.05Ω | | Rated current 1.0 Max. current 2.0 |
| YC248 | 1/16W | -55°C to +155°C | 50V | 100V | 100V | E24 ±5% 10Ω ≤ R ≤ 1MΩ E24/E96 ±1% 10Ω ≤ R ≤ 1MΩ Jumper < 0.05Ω | | Rated current 2.0 Max. current 10.0 |
| YC324 | 1/8W | -55°C to +155°C | 200V | 500V | 500V | E24 ±5% 10Ω ≤ R ≤ 1MΩ E24/E96 ±1% 10Ω ≤ R ≤ 1MΩ | | --- |
| TC122 | 1/16W | -55°C to +125°C | 50V | 100V | 100V | E24 ±5% 10Ω ≤ R ≤ 1MΩ E24/E96 ±1% 10Ω ≤ R ≤ 1MΩ Jumper < 0.05Ω | ±200 ppm/°C | Rated current 1.0 Max. current 1.5 |
| TC124 | 1/16W | -55°C to +125°C | 50V | 100V | 100V | E24 ±5% 10Ω ≤ R ≤ 1MΩ E24/E96 ±1% 10Ω ≤ R ≤ 1MΩ Jumper < 0.05Ω | | Rated current 1.0 Max. current 1.5 |
| TC164 | 1/16W | -55°C to +155°C | 50V | 100V | 100V | E24 ±5% 10Ω ≤ R ≤ 1MΩ E24/E96 ±1% 10Ω ≤ R ≤ 1MΩ Jumper < 0.05Ω | | Rated current 1.0 Max. current 2.0 |
| YC158T | 1/16W | -55°C to +155°C | 25V | 50V | 50V | E24 ±5% 10Ω ≤ R ≤ 100KΩ | | --- |
| YC358L YC358T | 1/16W | -55°C to +155°C | 50V | 100V | 100V | E24 ±5% 10Ω ≤ R ≤ 330KΩ | | --- |

FOOTPRINT AND SOLDERING PROFILES

For recommended footprint and soldering profiles, please refer to data sheet “Chip resistors mounting”.

PACKING STYLE AND PACKAGING QUANTITY

Table 3 Packing style and packaging quantity

| PACKING STYLE | PACKING STYLE | YC102/ 104 | YC/TC 122 | YC/TC 124 | YC162 | YC/TC 164 | YC248 | YC324 | YC158T | YC358L YC358T |
|----------------------------|---------------|---------------|--------------|--------------|-------|--------------|-------|-------|--------|------------------|
| Paper taping reel (R) | 7" (178mm) | 10,000 | 10,000 | 10,000 | 5,000 | 5,000 | 5,000 | --- | 5,000 | --- |
| | 13" (254mm) | 50,000 | 50,000 | 40,000 | --- | 20,000 | --- | --- | 20,000 | --- |
| Embossed taping reel (K) | 7" (178mm) | --- | --- | --- | --- | --- | 4,000 | 4,000 | --- | 4,000 |

NOTE

I. For tape and reel specification/dimensions, please refer to data sheet “Chip resistors packing”.

FUNCTIONAL DESCRIPTION

OPERATING TEMPERATURE RANGE

YC102/104/122/162, TC122/124 Range:

-55°C to +125°C (Fig.13)

YC124/164/248/324/158T/358L/358T, TC164 Range:

-55°C to +155°C(Fig.14)

POWER RATING

Each type rated power at 70°C

YC102/104 = 1/32 W

YC122/124/162/164/248/158T/358L/358T = 1/16 W

YC324 = 1/8 W

TC122/124/164 = 1/16 W

RATED VOLTAGE

The DC or AC (rms) continuous working voltage corresponding to the rated power is determined by the following formula:

$$V = \sqrt{(P \times R)}$$

or max. working voltage whichever is less

Where

V=Continuous rated DC or AC (rms) working voltage (V)

P=Rated power (W)

R=Resistance value (Ω)

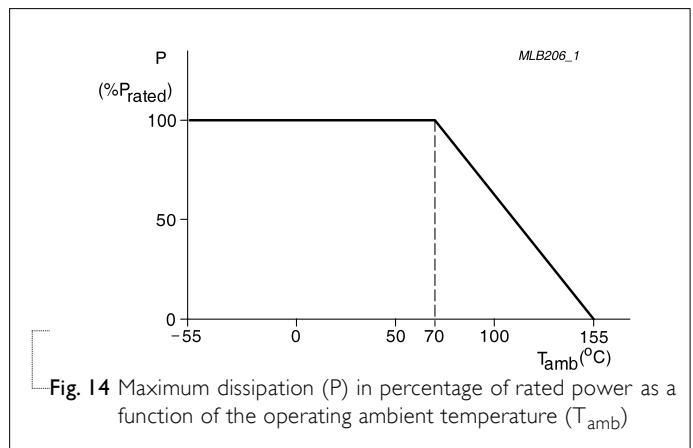

TESTS AND REQUIREMENTS
Table 4 Test condition, procedure and requirements

| TEST | TEST METHOD | PROCEDURE | REQUIREMENTS |
|--|--------------------------|---|--|
| Life/ Operational Life/ Endurance | MIL-STD-202G-method 108A | 1,000 hours at 70±5 °C applied RCWV | ±(2%+0.05 Ω) |
| | IEC 60115-1 4.25.1 | 1.5 hours on, 0.5 hour off, still air required | <100 mΩ for Jumper |
| | JIS C 5202-7.10 | | |
| High Temperature Exposure/ Endurance at Upper Category Temperature | MIL-STD-202G-method 108A | 1,000 hours at maximum operating | ±(1%+0.05 Ω) |
| | IEC 60115-1 4.25.3 | temperature depending on specification, unpowered | <50 mΩ for Jumper |
| | JIS C 5202-7.11 | No direct impingement of forced air to the parts Tolerances: 125±3 °C | |
| Moisture Resistance | MIL-STD-202G-method 106F | Each temperature / humidity cycle is defined at | ±(2%+0.05 Ω) |
| | IEC 60115-1 4.24.2 | 8 hours (method 106F), 3 cycles / 24 hours for 10d with 25 °C / 65 °C 95% R.H, without steps 7a & 7b, unpowered | <100 mΩ for Jumper |
| | | Parts mounted on test-boards, without condensation on parts Measurement at 24±2 hours after test conclusion | |
| Thermal Shock | MIL-STD-202G-method 107G | -55/+125 °C | ±(1%+0.05 Ω) |
| | | Note: Number of cycles required is 300. Devices mounted | <50 mΩ for Jumper |
| | | Maximum transfer time is 20 seconds. Dwell time is 15 minutes. Air – Air | |
| Short Time Overload | MIL-R-55342D-para 4.7.5 | 2.5 times RCWV or maximum overload | ±(2%+0.05 Ω) |
| | IEC60115-1 4.13 | voltage whichever is less for 5 sec at room temperature | <50 mΩ for Jumper No visible damage |
| Board Flex/ Bending | IEC60115-1 4.33 | Device mounted on PCB test board as described, only 1 board bending required | ±(1%+0.05 Ω) |
| | | 3 mm bending | <50 mΩ for Jumper |
| | | Bending time: 60±5 seconds | No visible damage |
| | | Ohmic value checked during bending | |

| TEST | TEST METHOD | PROCEDURE | REQUIREMENTS |
|-----------------------------------|--|--|--|
| Solderability - Wetting | IPC/JEDECJ-STD-002B test B IEC 60068-2-58 | Electrical Test not required Magnification 50X SMD conditions: 1 st step: method B, aging 4 hours at 155 °C dry heat 2 nd step: leadfree solder bath at 245±3 °C Dipping time: 3±0.5 seconds | Well tinned (≥95% covered) No visible damage |
| - Leaching | IPC/JEDECJ-STD-002B test D IEC 60068-2-58 | Leadfree solder, 260 °C, 30 seconds immersion time | No visible damage |
| - Resistance to Soldering Heat | MIL-STD-202G-method 210F IEC 60068-2-58 | Condition B, no pre-heat of samples Leadfree solder, 260 °C, 10 seconds immersion time Procedure 2 for SMD: devices fluxed and cleaned with isopropanol | ±(1%+0.05 Ω) <50 mΩ for Jumper No visible damage |

REVISION HISTORY

| REVISION | DATE | CHANGE NOTIFICATION | DESCRIPTION |
|-----------|---------------|---------------------|--|
| Version 7 | Aug. 22, 2017 | - | - Correct the typo for YC158T/358L/358T, Marking, "240" is 24ohm |
| Version 6 | Jun. 1, 2017 | - | - Update ordering information for networks YC158T/YC358L/YC358T |
| Version 5 | Feb. 14, 2017 | - | - Update YC158 and 358 part number to YC158T, YC358L and YC358T |
| Version 4 | Dec. 22, 2016 | - | - Delete YC102 default code L type |
| Version 3 | Apr. 29, 2016 | - | - Update YC series and TC164 dimension |
| Version 2 | Dec. 11, 2015 | - | - Update Operating Temperature |
| Version 1 | Feb. 04, 2015 | - | - Update YC102 to flat type |
| Version 0 | Nov. 14, 2014 | - | - First issue of this specification |

“Yageo reserves all the rights for revising the content of this datasheet without further notification, as long as the products itself are unchanged. Any product change will be announced by PCN.”

Mouser Electronics

Authorized Distributor

Click to View Pricing, Inventory, Delivery & Lifecycle Information:

Yageo:

[TC164-FR-0733R2L](#) [TC164-FR-0724RL](#) [TC164-FR-0727RL](#) [TC164-FR-0751RL](#) [TC164-FR-072K21L](#) [TC164-FR-078K25L](#) [TC164-FR-0715KL](#) [TC164-FR-071ML](#) [TC164-FR-0724R9L](#) [TC164-FR-07499RL](#) [TC164-FR-072K7L](#) [TC164-FR-072KL](#) [TC164-FR-077K5L](#) [TC124-JR-077R5L](#) [TC124-JR-073RL](#) [TC164-FR-0756RL](#) [TC164-FR-0751R1L](#) [TC164-FR-072K4L](#) [TC164-FR-07330KL](#) [TC164-FR-07402RL](#) [TC124-FR-074K7L](#) [TC124-FR-0739RL](#) [TC164-FR-0718RL](#) [TC164-FR-0713KL](#) [TC164-FR-077K68L](#) [TC124-FR-0747RL](#) [TC164-FR-073K32L](#) [TC164-FR-071K82L](#) [TC164-FR-071K3L](#) [TC164-FR-0746R4L](#) [TC164-FR-0762KL](#) [TC164-FR-0711KL](#) [TC164-FR-07560KL](#) [TC124-JR-075R1L](#) [TC164-FR-07430KL](#) [TC124-FR-07100KL](#) [TC164-FR-07200KL](#) [TC164-FR-07510RL](#) [TC124-FR-0722RL](#) [TC124-FR-0733RL](#) [TC164-JR-075R1L](#) [TC164-FR-0727R4L](#) [TC164-FR-07680KL](#) [TC124-FR-07330RL](#) [TC124-FR-075K1L](#) [TC164-JR-073RL](#) [TC164-FR-0736KL](#) [TC124-FR-071KL](#) [TC124-FR-0756RL](#) [TC124-FR-072K4L](#) [TC164-FR-078K2L](#) [TC164-FR-0782KL](#) [TC164-FR-071K62L](#) [TC124-FR-0760R4L](#) [TC124-FR-0724R9L](#) [TC164-FR-0724KL](#) [TC164-FR-0756KL](#) [TC122-JR-073RL](#) [TC164-FR-07110RL](#) [TC164-FR-0718KL](#) [TC164-FR-0775RL](#) [TC164-FR-07390KL](#) [TC164-FR-0756R2L](#) [TC164-FR-0730R1L](#) [TC164-FR-076K8L](#) [TC164-FR-07332RL](#) [TC164-FR-076K2L](#) [TC164-FR-073KL](#) [TC164-FR-0775KL](#) [TC164-FR-07120KL](#) [TC164-FR-0751K1L](#) [TC164-FR-079K1L](#) [TC164-FR-075K1L](#) [TC164-FR-07180RL](#) [TC164-FR-0739KL](#) [TC164-FR-0791KL](#) [TC164-FR-071K2L](#) [TC164-FR-07750RL](#) [TC164-FR-07150KL](#) [TC164-FR-0751KL](#) [TC164-FR-0784R5L](#) [TC164-FR-07200RL](#) [TC124-FR-0762RL](#) [TC164-FR-073K6L](#) [TC124-FR-0727R4L](#) [TC164-FR-0739RL](#) [TC124-FR-0751RL](#) [TC124-FR-0733KL](#) [TC124-FR-0710KL](#) [TC124-FR-0749R9L](#) [TC164-FR-07160KL](#) [TC124-FR-07619RL](#) [TC164-FR-1320KL](#) [TC164-JR-1322KL](#) [TC164-JR-1327KL](#) [TC164-FR-1347KL](#) [TC164-JR-10100KL](#) [TC124-JR-0782RL](#) [TC164-FR-1368KL](#) [TC164-JR-132K2L](#)

Компания «Life Electronics» занимается поставками электронных компонентов импортного и отечественного производства от производителей и со складов крупных дистрибьюторов Европы, Америки и Азии.

С конца 2013 года компания активно расширяет линейку поставок компонентов по направлению коаксиальный кабель, кварцевые генераторы и конденсаторы (керамические, пленочные, электролитические), за счёт заключения дистрибьюторских договоров

Мы предлагаем:

- Конкурентоспособные цены и скидки постоянным клиентам.
- Специальные условия для постоянных клиентов.
- Подбор аналогов.
- Поставку компонентов в любых объемах, удовлетворяющих вашим потребностям.
- Приемлемые сроки поставки, возможна ускоренная поставка.
- Доставку товара в любую точку России и стран СНГ.
- Комплексную поставку.
- Работу по проектам и поставку образцов.
- Формирование склада под заказчика.
- Сертификаты соответствия на поставляемую продукцию (по желанию клиента).
- Тестирование поставляемой продукции.
- Поставку компонентов, требующих военную и космическую приемку.
- Входной контроль качества.
- Наличие сертификата ISO.

В составе нашей компании организован Конструкторский отдел, призванный помогать разработчикам, и инженерам.

Конструкторский отдел помогает осуществить:

- Регистрацию проекта у производителя компонентов.
- Техническую поддержку проекта.
- Защиту от снятия компонента с производства.
- Оценку стоимости проекта по компонентам.
- Изготовление тестовой платы монтаж и пусконаладочные работы.



Тел: +7 (812) 336 43 04 (многоканальный)

Email: org@lifeelectronics.ru