

V-Series Switch

Product Highlights:

- ♦ Maximum sealing protection with dual seals around lamps and rocker stem certified to IP66 & IP68. Optional panel seals for additional protection.
- ♦ Silver plated butt contact mechanism provides 50 to 100 thousand electrical cycles and a variety of different electrical ratings.
- ♦ Roller pin mechanism does not require lubricants and allows the switch to withstand extreme temperatures.
- ♦ The switch base accommodates up to 10 terminals and a large variety of switch and lighting circuits.
- ♦ The multi-step mounting wings provide a secure fit for panel thicknesses of 0.032" thru 0.250" in an industry standard 0.830" x 1.450" mounting hole.
- ♦ The switch connector allows the user to preload FQC terminals for easy assembly to switch base.
- ♦ Numerous choices of removable rockers allow for style change without having to retest or re-qualify the switch base.
- ♦ Illumination options are endless with bar, oval, and square lenses available in choices of incandescent, neon and a wide variety of LEDs including superbrite, megabrite, flashing and bicolor lighting.
- ♦ Available with a variety of complimentary mounting panels, hole plugs, illuminated indicators and boots to accommodate most any design need.



CONTURA III



CONTURA II



CONTURA V



CONTURA VII

Carling Technologies' fully sealed V-Series Contura switches are well known for their cutting edge design, high quality, maximum performance and unmatched reliability. These switches are a staple in the marine and transportation industries and have passed a range of environmental, corrosion, temperature, vibration, shock and sealing tests including MIL Std 202F, MIL Std 810C, UL 1500, ISO 8846, IEC 60529 and BS 5490 among others, making them one of the most rugged and reliable switches ever manufactured.



Carling Technologies®

Innovative Designs. Powerful Solutions.

Innovative Designs. Powerful Solutions.

Carling Technologies, Inc.
60 Johnson Avenue • Plainville, CT 06062-1177
Phone: (860) 793-9281 • Fax: (860) 793-9231
Email: sales@carlingtech.com • www.carlingtech.com

V-Series Switch

DESIGN FEATURES

MAXIMUM DESIGN OPTIONS WITH MINIMUM INVENTORIES

Panel redesign is a snap, requiring no tooling change, with our removable interchangeable actuators. A unique balance between aesthetics and functionality.

SEALS OUT WATER, DUST AND DEBRIS

Dual seal protection locks out elements. Certified to IP66/IP68 for front panel components.

CLEAN CONNECTIONS

Offered in both eight and ten terminal base options. AMP & Packard compatible connectors available.

SILVER PLATED BUTT

Contact mechanism provides 50 to 100 thousand electrical cycles and a variety of different electrical ratings.

WITHSTANDS EXTREME TEMPERATURES

Roller pin mechanism eliminates the need for lubricants. Enables switch to withstand -40°C to +85°C temperatures.

MULTIPLE LIGHTING OPTIONS

Incandescent lamps & LED lighting. Our LED illumination is offered in a wide array of light intensities, colors, as well as dual level, tri-color, and flashing options.

OPTIONAL PANEL SEAL

Prevents water/dust egress behind panel.

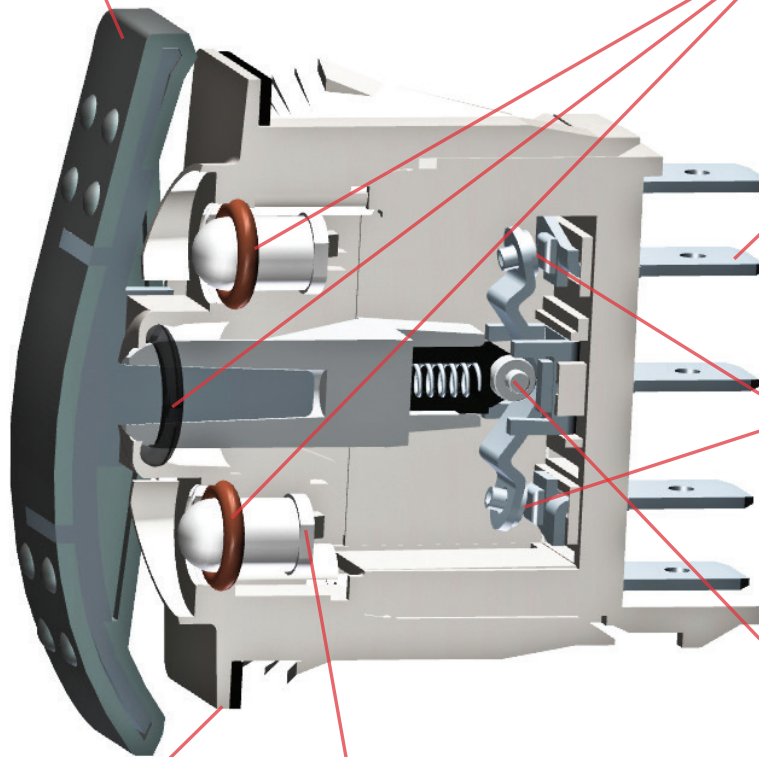



Contura II & III

The Contura II & III actuators are constructed of thermoplastic polycarbonate and are offered with a hard nylon overlay or a "soft-touch" elastomer overlay. These models incorporate aesthetic designs on the top and bottom of the rocker featuring two rows of raised "bumps" on the Contura II and three "indented" lines on the Contura III.



Contura X

The raised bracket/bezel on the Contura X helps prevent inadvertent actuation of the rocker, as well as preventing debris from being trapped under the actuator. This curved rocker style is available with a variety of lenses and legends.



Contura IV

The Contura IV's "Shape to create a Shape" actuator works with the curves, contours & advanced styling of the latest panel designs, flowing with these advanced curves & radii. This actuator style fits on the Contura flush bracket/bezel.



Contura XI

The raised bracket/bezel on the Contura XI helps prevent inadvertent actuation of the rocker, as well as preventing debris from being trapped under the actuator. This convex style rocker is available with a wide variety of lenses and legends.



Contura V

The symmetrically curved Contura V actuator provides the perfect complement to the Contura IV's "Shape to create a Shape" design concept. With its flush style mounting bracket, Contura V can be mounted in between two Contura IV's, by itself, or in groups.



Contura XII

The Contura XII version features a paddle style actuator with the raised bracket/bezel of Contura X and XI. The contoured handle design provides intuitive recognition and ease of operation and is available with all Contura X and XI lens and legend offerings.



Contura VI (WAVE)

The Contura VI WAVE sealed rocker switches, when used in a row, create an uniquely appealing "wave" design on your panel. A variety of colors and finishes are available for both rocker and wave insert. Contura VI features bar and oval lenses.



Illuminated Indicator

The Illuminated Indicator is offered with removable/ replaceable lamps and Contura II, III, V, or X styling. Illumination alerts the operator of essential system functions or malfunctions like: oil pressure, high temperature, fluid levels, parking brake, or general system malfunction.



Contura VII

Contura VII featuring gently curved corners and edges assuring compatibility with most any panel design. Intuitive feel is maximized by the use of 2 embossed circular pads located at opposite ends of the rocker. Any combination of Bar or Oval style lenses can be located in the pads providing a truly unique look, exclusive to Contura VII.



V-Series Accessories/Options

Carling Technologies also offers many V-Series accessories including connectors, mounting panels, hole plugs, panel seals, and actuator removal tools.

Electrical

Contact Rating	4VA @ 28VDC (MAX) resistive 15 amps, 125VAC 10 amps, 250VAC 1/2 HP 125-250VAC 20 amps, 4-14VDC 15 amps, 15-28VDC 10A, 14VT 6A, 125VAC L
Dielectric Strength	1500 Volts RMS
Insulation Resistance	50 Megohms
Initial Contact Resistance	10 milliohms max. @ 4VDC
Life	50,000- 100,000 cycles circuit dependent
Contacts	Silver alloy, silver tin-oxide, fine silver
Terminals	Brass or copper/silver plate 1/4" (6.3mm) Quick Connect terminations standard. Solder lug, Wire Lead

Mechanical

Endurance	150,000 cycles minimum circuit dependent
-----------	---

Physical

Lighted	Incandescent - rated 10,000 hours Neon - rated 25,000 hours LED - rated 100,000 hours 1/2 life (LED is internally ballasted for voltages to 24VDC)
Seals	Internal
Base	Optional external gasket panel seal Polyester blend rated to 125°C with a UL flammability rating of 94V0.
Contura II, III, IV, V, VI Actuator	Hard Surface: Basic actuator structure molded of thermoplastic polycarbonate with a hard Nylon 66 thermoplastic surface overlay. Soft Surface: Basic actuator structure molded of thermoplastic polycarbonate with an elastomer overlay.
Contura X, XI, XII Actuator, VP Lens	Nylon 66 Reinforced rated to 105°C Polycarbonate rated at 100°C

Actuator Travel (Angular Displacement)

2 position	18°
3 positions	9° from center

Mounting Specifications

Panel Thickness Range	
# of gaskets	Acceptable Panel Thickness
0	.030 to .250 (.76mm to 6.35mm)
1	.030 to .109 & .147 to .157 (.76 to 2.77mm & 3.73 to 3.98mm)
Recommended:	No gasket with panel thickness of .032, .062, .093, .125, .187 or .250



Agency Certifications



Environmental

Environmental	Sealed version: IP68, in accordance with IEC 60529, BS 5490, DIN 40050 & NFC 20 010. This rating applies to front panel components of the actual switch only, and signifies protection against dust and the prolonged effects of immersion under pressure. The standard test for immersion under pressure requires submersion under one meter of water for 30 minutes. The V-Series switch has exceeded these parameters, having been actuated and illuminated during submersion.
Corrosion	Flowing Mixed Gas (FMG) Class III 3 year accelerated exposure per ASTM B-827, B-845 Silver and gold contacts
Operating Temperature	-40°C to + 85°C
Vibration 1	Per Mil-Std 202F, Method 204D Test Condition A 0.06 DA or 10G's 10-500 Hz. Tested with VCH connector. Test criteria - No loss of circuit during test and pre and post test contact resistance.
Vibration 2	Resonance search 24-50 Hz 0.40 DA 50-2000 ±10 G's peak Results Horizontal Axis 3-5 G's max. Random 24 Hz 0.06 PSD-Gsq/Hz 60 Hz 0.50 100 Hz 0.50 200 Hz 0.025 2000 Hz 0.025 No loss of circuit during test; <10µ seconds chatter.
Shock	Per Mil-Std 202F, Method 213B, Test Condition K @ 30G's. Tested with VCH connector. Test criteria - No loss of circuit during test, pre and post test contact resistance.
Salt Spray	Per Mil-Std 202F, Method 101D, Test Condition A, 48 Hrs. Sealed version only.
Dust	Per Mil-Std 810C, Method 510.2 Air Velocity 300 ±200 Feet/Min, Test Duration 16 Hrs.
Thermal Shock	Per Mil-Std 202F, Method 107F, Test Cond. A, -55°C to 85°C. Test criteria - pre and post test contact resistance
Moisture Resistance	Per Mil-Std 202F, Method 106F, Test Criteria - pre and post test contact resistance
Ignition Protection	All Contura switches with sealed construction meet the requirements of UL1500/ISO8846 for ignition protection, in addition to conformance with EC directive 94/25/EC for marine products.

Dimensional Specifications: in. [mm]

CONTURA II STYLE

SHOWN WITH
SQUARE LENS

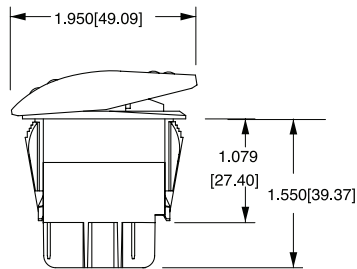

**8 TERMINAL BASE
W/BARRIERS**

CONTURA III STYLE

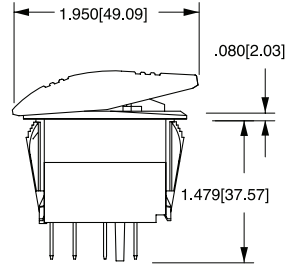

**8 TERMINAL BASE
W/O BARRIERS**

CONTURA IV STYLE

SHOWN WITH
BAR LENS

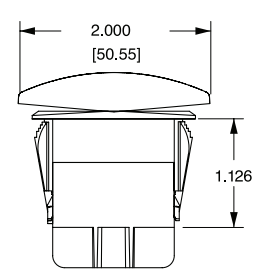

**10 TERMINAL BASE
W/BARRIERS**



**8 TERMINAL BASE
W/BARRIERS**



**10 TERMINAL BASE
W/BARRIERS**

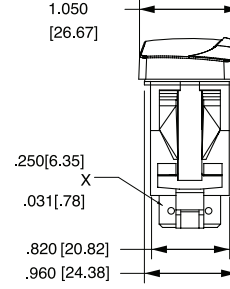

**10 TERMINAL BASE
W/O BARRIERS**



**SWITCH SHOWN WITH
VCH CONNECTOR 8
TERMINAL**

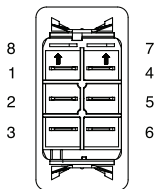

**BOTTOM VIEW
TERMINAL
ARRANGEMENT
8 TERMINAL BASE**

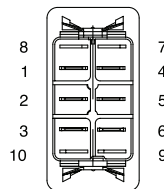

**BOTTOM VIEW
TERMINAL
ARRANGEMENT
10 TERMINAL BASE**

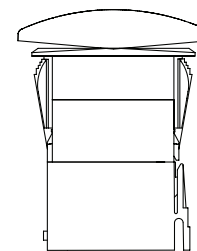

**SWITCH SHOWN WITH
VC1 CONNECTOR 10
TERMINAL**

Dimensional Specifications: in. [mm]

CONTURA V

SHOWN WITH
BAR LENS

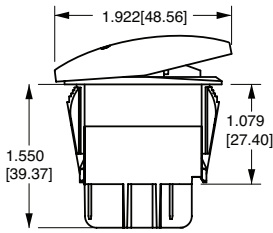

**8 TERMINAL BASE
W/BARRIERS**

CONTURA V

SHOWN WITH
LOW PROFILE LOCK

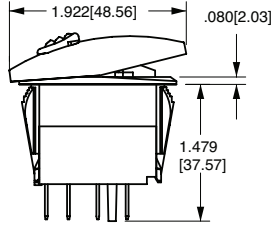

**8 TERMINAL BASE
W/O BARRIERS**

CONTURA VI

SHOWN WITH OVAL
LENS

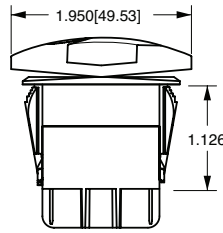

**10 TERMINAL BASE
W/BARRIER AND
LAMP TERMINAL**

CONTURA VII

SHOWN WITH LARGE LENS
AND BAR LENS

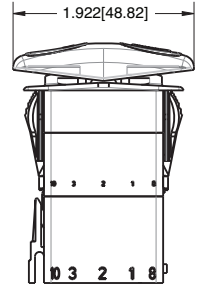

**10 TERMINAL BASE
W/O BARRIERS**

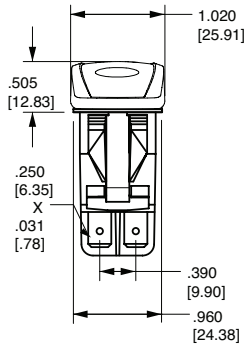

**8 TERMINAL BASE
W/BARRIERS**

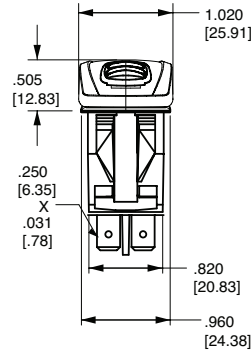

**8 TERMINAL BASE
W/O BARRIERS**

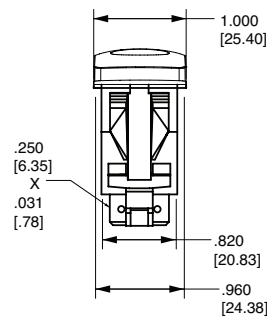

**10 TERMINAL BASE
W/O BARRIERS**

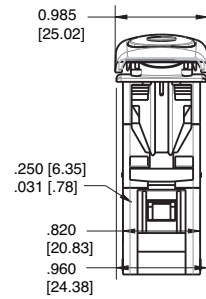

**10 TERMINAL BASE
W/O BARRIERS**

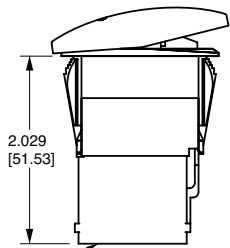

SWITCH SHOWN WITH
VCH CONNECTOR 8
TERMINAL



**BOTTOM VIEW
TERMINAL
ARRANGEMENT
8 TERMINAL BASE**



**BOTTOM VIEW
TERMINAL
ARRANGEMENT
10 TERMINAL BASE**

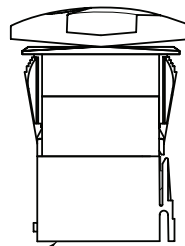

SWITCH SHOWN WITH
VC1 CONNECTOR 10
TERMINAL

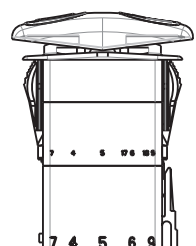

SWITCH SHOWN WITH VC1
CONNECTOR 10
TERMINAL

Dimensional Specifications: in. [mm]

CONTURA STOLE
CONTURA STOLE



**8 TERMINAL BASE
 W/BARRIERS**

CONTURA STOLE
CONTURA STOLE

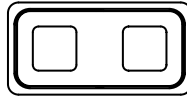

**10 TERMINAL BASE
 W/O BARRIERS**

CONTURA STOLE
CONTURA STOLE



**8 TERMINAL BASE
 W/O BARRIERS**



**8 TERMINAL BASE
 W/BARRIERS**

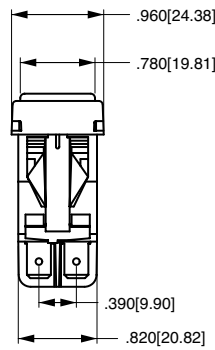

**10 TERMINAL BASE
 W/BARRIERS**



**10 TERMINAL
 BASE
 W/O BARRIERS**

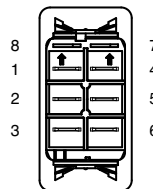

**BOTTOM VIEW
 TERMINAL
 ARRANGEMENT
 8 TERMINAL BASE**

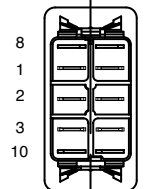

**BOTTOM VIEW
 TERMINAL
 ARRANGEMENT
 10 TERMINAL BASE**

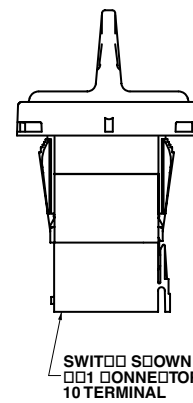

CIRCUIT	CIRCUIT DIAGRAM
1	
2	
3	
4	
5	
6	
7	
8	

CIRCUIT	CIRCUIT DIAGRAM
A	
B	
C	
D	
E	
F	
G	
H	

CIRCUIT	CIRCUIT DIAGRAM
J	
K	
L	
M	
R	
S	

SYMBOL LEGEND	
SYM.	DEFINITION
	DESIGNATES TERMINALS AND CONTACTS
	DESIGNATES LAMP LOCATION
	DESIGNATES MAINTAINED CIRCUITS
	DESIGNATES OTHER POSITION
	DESIGNATES MOMENTARY CIRCUITS
	DESIGNATES TWO POSITION CONNECTION
	DESIGNATES EXTERNAL JUMPER PROVIDED BY CUSTOMER



NOTE:
J circuits are available for all non-locking V-Series styles. Consult factory for p/n details.

SYMBOL LEGEND	
SYM.	DEFINITION
○	DESIGNATES TERMINALS AND CONTACTS
○	DESIGNATES LAMP LOCATION
○	DESIGNATES TWO POSITION CIRCUIT

CIRCUIT	CONNECTOR PART #
JA, JJ, JK	JC1-01
J1, J3, J4, J5	JC2-01
J2	JC3-01

V 1 D A B T O B — A R B 00 — 0 00

1 Series 2 Circuit 3 Rating 4 Termination Illumination Lamp 5 Lamp 6 Lamp 7 Lamp 8 Bracket 9 Actuator 10 Lens 11 Color 12 Legend 13 Legend Orientation 14 Actuator Lens Legend

1 SERIES
V

2 CIRCUIT
Terminal Connections as viewed from bottom of switch:
8 terminal 10 terminal
1 - -7 8 - -7
2 - -4 1 - -4
3 - -5 2 - -5
4 - -6 3 - -6
5 - -9 10 - -9

() - momentary
SP - single pole - uses terminals 1, 2 & 3.
DP - double pole uses terminals 1, 2, 3, 4, 5 & 6.
Terminals 7, 8, 9 & 10 for lamp circuit only.

Position:

	1	2	3
SP	2 & 3, 5 & 6	Connected Terminals	1 & 2, 4 & 5
1	ON	NONE	OFF
2	(ON)	NONE	OFF
3	ON	NONE	(OFF)
4	ON	NONE	ON
5	ON	NONE	(ON)
6	ON	NONE	ON
7	ON	OFF	ON
8	ON	OFF	(ON)
9	(ON)	OFF	(ON)

SPECIAL CIRCUITS

H*	2 & 3	2 & 3, 5 & 4	5 & 4
G*	2 & 3, 5 & 6	2 & 3	OFF
S	2 & 3, 5 & 6	2 & 3	1 & 2
M*	(2 & 3, 5 & 6)	2 & 3	OFF
R	(2 & 3, 5 & 6)	2 & 3	1 & 2
E*	5 & 6	5 & 3	5 & 1

*Jumper between terminals 2 & 5 for circuits H, G, & M are specified in selection 4.
External jumper between terminals 2 & 4 for circuit E are provided by customer. Circuit E may be used for SP OFF-ON-ON circuit.

3 RATING³

1 .4VA @ 28VDC Resistive
B 15A 24V
C 20A 18V
D 20A 12V
E 20A 14V, 10A 14VT (circuit 1, 4, A & D only)
F 10A 14V, 6A 14VT (circuit G only)
M .4VA/20A 12V
N .4VA/15A 24V

4 TERMINATION/BASE STYLE

8 term	10 term	Termination	Jumper
1	2	.250 TAB (QC) no barriers	No
A	B	.250 TAB (QC) with barriers	No
J	K	.250 TAB (QC) no barriers	Yes T2 to 5
3	4	Solder Lug no barriers	No
C	D	Solder Lug	No
5	6	Wire Leads no barriers	No
E	F	Wire Leads	No

Note: Codes J & K for circuits H, G & M.

5 ILLUMINATION & SWITCH SEALING
Lamp #1: above terminals 1 & 4 end of switch.; Lamp #2 above terminals 3 & 6 end of switch. Positive (+) and negative (-) symbols apply to LED lamps only

Sealed	Unsealed	Lamps	Actuator Lens position when Illuminated	Lamp wired to Terminals
S	0	NONE		
A	1	# 1	Independent	8+ 7-
B	2	# 1	Down	3+ 7-
C	3	# 2	Up	3+ 7-
D	4	# 1	Down	3+ 7-
E	5	# 1	Down	1+ 7-
F	6	# 1	Up	3+ 7-
G	7	# 1	Independent	8+ 7-
H	Z	# 2	Up	3+ 7-
U	Y	# 1	Independent	8+ 7-
		# 2	Independent	10+ 9-

Selections for Single Pole Switches Only:

J	8	# 1	Down	3+ 8-
K	W	# 1	Independent	8+ 7-
		# 2	Independent	8+ 7-
		# 2	Independent	6+ 7-

Selections for Double Pole Switches Only:

L	9	# 1	Down	3+ 6-
M	R	# 2	Up	3+ 6-
N	T	# 1	Down	3+ 6-
P	V	# 1	Down	1+ 4-
		# 2	Up	1+ 4-

6,7 LAMP (SAME CODING FOR BOTH SELECTIONS)
Selection 6: above terminals 1 & 4; Selection 7: above terminals 3 & 6

No lamp	0	1 125VAC	2 250VAC	6 12V superbright Green	7 18V superbright Red	8 24V superbright Red
Neon	1	4 3V	5 6V			
Incandescent LED*		Red	Amber			
2VDC	A	L	F			
6VDC	B	M	G			
12VDC	C	N	H			
24VDC	D	P	J			

* Consult factory for "daylight bright" LED options. Typical current draw for LED is 20ma.

8 FLUSH BRACKET COLOR¹, PANEL SEAL

No Seal	Black	White	Gray
One Seal	B	W	G
	C	Y	H

9 ACTUATOR

No Actuator	0		
Contura II	A		
Contura III	B		
	C		
	D		

Actuator orientation above terminals: 3,6 1,4

10 LENS

0 - No Actuator	Z - No Lens	Green	Red	Blue
Clear	White	Amber		
1	6	B	G	M
2	7	C	H	N
3	8	D	J	P
4	9	E	K	R
5	A	F	L	S
				W
				Y

Square lens options available only for Contura II:
4 9 E K R W
5 A F L S Y

Lens color for LEDs must be clear, white, or match color of LED.
Green or blue lenses are not recommended with Neon lamps.

11 ACTUATOR COLOR¹ AND TEXTURE

0 - No Actuator	Black	Gray	Red	White
Soft Surface	B	G	R	W
Hard Surface	C	H	S	Y

12 ACTUATOR LENS OR BODY LEGENDS²

11 ON	12 OFF	13 I	14 O
OFF	ON	O	I
15 OO	16 OO	17 OI	18 IO
F N	F N		
F	F		

For additional legend options & codes, visit us at www.carlingtech.com.

13 LEGEND ORIENTATION

0 No legend (used with codes 11-18 in selection 12)
1 Orientation 1
2 Orientation 2
3 Orientation 3
4 Orientation 4

14 ACTUATOR LENS LEGEND

00 No legend this location / no actuator (used with codes 11-18 in selection 12) Selection 14 required when switch requires two legends. If the two legends consist of one lens and one body legend, lens legend must be specified in selection 12; body legend specified in selection 14.
For legend options & codes, visit us at www.carlingtech.com.

- Notes:
- 1 Consult factory to verify horsepower rating for your particular circuit choice.
 - 2 Custom colors are available. Consult factory.
 - 3 Body legends not available on Soft surface actuators; White imprinting is standard on black actuators; Black imprinting is standard on white, red and gray actuators; Custom colors are available, consult factory.
 - 4 Additional ratings available. See page 20.
 - 5 Contura II available with two square lenses. Consult factory for details.

V	1	D	A	S	W	O	B	—	A	Z	E	00	—	0
1 Series	2 Circuit	3 Rating	4 Termination	5 Illumination	6 Lock	7 Lamp	8 Bracket		9 Actuator	10 Lens	11 Function	12 Legend		13 Legend Orientation

1 SERIES
V

2 CIRCUIT
Terminal Connections as viewed from bottom of switch:

8 terminal	10 terminal	() - momentary
8 - -7	8 - -7	SP - single pole - uses terminals 1, 2 & 3.
1 - -4	1 - -4	DP - double pole uses terminals 1, 2, 3, 4, 5 & 6.
2 - -5	2 - -5	Terminals 7, 8, 9 & 10 for lamp circuit only.
3 - -6	3 - -6	
	10 - -9	

Position:

	1	2	3
SP	2 & 3, 5 & 6	Connected Terminals	1 & 2, 4 & 5
1	ON	NONE	OFF
2	(ON)	NONE	OFF
3	ON	NONE	(OFF)
4	ON	NONE	ON
5	ON	NONE	(ON)
6	ON	NONE	ON
7	ON	OFF	ON
8	ON	OFF	(ON)
	(ON)	OFF	(ON)

SPECIAL CIRCUITS

H*	2 & 3	2 & 3, 5 & 4	5 & 4
G*	2 & 3, 5 & 6	2 & 3	OFF
S*	2 & 3, 5 & 6	2 & 3	1 & 2
M*	(2 & 3, 5 & 6)	2 & 3	OFF
E*	(2 & 3, 5 & 6)	2 & 3	1 & 2
	5 & 6	5 & 3	5 & 1

*Jumper between terminals 2 & 5 for circuits H, G, & M are specified in selection 4. External jumper between terminals 2 & 4 for circuit E are provided by customer. Circuit E may be used for SP OFF-ON-ON circuit.

3 RATING⁴

1	.4VA @ 28VDC Resistive
B	15A 24V
C	20A 18V
D	20A 12V
E	20A 14V, 10A 14VT (circuit 1, 4, A & D only)
F	10A 14V, 6A 14VT (circuit G only)
M	.4VA/20A 12V
N	.4VA/15A 24V

4 TERMINATION/BASE STYLE

8 term	10 term	Termination	Jumper
1	2	.250 TAB (QC) no barriers	No
A	B	.250 TAB (QC) with barriers	No
J	K	.250 TAB (QC) no barriers	Yes T2 to 5
3	4	Solder Lug no barriers	No
C	D	Solder Lug	No
5	6	Wire Leads no barriers	No
E	F	Wire Leads	No

Note: Codes J & K for circuits H, G & M.

5 ILLUMINATION & SWITCH SEALING

Lamp #1: above terminals 1 & 4 end of switch.; Lamp #2 above terminals 3 & 6 end of switch. Positive (+) and negative (-) symbols apply to LED lamps only

Sealed	Unsealed	Lamps	Actuator Lens position when Illuminated	Lamp wired to Terminals
S	0	NONE		
C	3	# 2	Up	3+ 7-
H	Z	# 2	Independent	8+ 7-

Selections for Double Pole Switches Only:

M	R	# 2	Up	3+ 6-
----------	----------	-----	----	-------

6 LOCK
Lock above terminals 1 & 4 end of switch.
W lock

Notes:
Consult factory to verify horsepower rating for your particular circuit choice.

- 1 Custom colors are available. Consult factory.
- 2 White imprinting is standard on black actuators; Black imprinting is standard on white, red and gray actuators; Custom colors are available, consult factory.
- 3 Only available with 3 position circuits. Center OFF and special circuits only available with center position lock function.
- 4 Additional ratings available. See page 20.

7 LAMP
Lamp above terminals 3 & 6 end of switch

No lamp	0				
Neon	1 125VAC	2 250VAC			
Incandescent	4 3V	5 6V	6 12V superbright	7 18V superbright	8 24V superbright
LED*			Green	Red	
	Red	Amber			
2VDC	A	L	F	R	
6VDC	B	M	G	S	
12VDC	C	N	H	T	
24VDC	D	P	J	V	

* Consult factory for "daylight bright" LED options. Typical current draw for LED is 20ma.

8 FLUSH BRACKET COLOR¹, PANEL SEAL

No Seal	Black	White	Gray
One Seal	B	W	H
	C	Y	

9 HARD SURFACE ACTUATOR¹

Contura II	Black A	Grey B	Red G	White H
Contura III	C	D	E	F

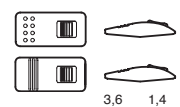

Actuator orientation above terminals: 3,6 1,4

10 LENS
Z - No Lens

Clear	White	Amber	Green	Red	Blue
3	8	D	J	P	V

Lens color for LEDs must be clear, white, or match color of LED. Green or blue lenses are not recommended with Neon lamps.



11 ACTUATOR LOCK FUNCTION AND COLOR¹

Lock Color	Up	Down	Up & Down	Center ³
Match Actuator	A	H	R	1
Black	B	J	S	2
White	C	K	T	3
Red	D	L	V	4
Safety Orange	E	M	W	5

12 ACTUATOR LENS OR BODY LEGEND²

00 - No Legend

21	22	23	24
OFF	ON	O	I
25	26	27	28
O	O	O	I
F	N		



For additional legend options & codes, visit us at www.carlingtech.com.

13 LEGEND ORIENTATION

0 No legend (used with codes 21-28 in selection 12)

1 Orientation 1

2 Orientation 2

3 Orientation 3

4 Orientation 4

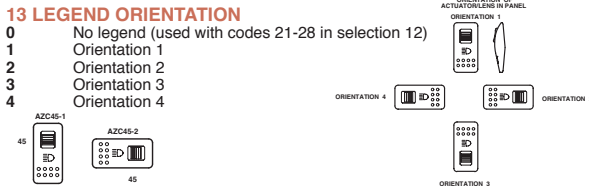

V	1	D	A	B	T	O	B	E	P	C	00	0	00
1 Series	2 Circuit	3 Rating	4 Termination	5 Illumination	6 Lamp	7 Lamp	8 Bracket	9 Actuator	10 Lens	11 Color	12 Legend	13 Legend Orientation	14 Actuator Lens Legend

1 SERIES
V

2 CIRCUIT
Terminal Connections as viewed from bottom of switch: () - momentary

8 terminal	10 terminal	SP - single pole - uses terminals 1, 2 & 3.
8 - -7	8 - -7	DP - double pole uses terminals 1, 2, 3, 4, 5 & 6.
1 - -4	1 - -4	Terminals 7, 8, 9 & 10 for lamp circuit only.
2 - -5	2 - -5	
3 - -6	3 - -6	
	10 - -9	

Position:

Position	DP	1	2	3
1	A	ON	NONE	OFF
2	B	(ON)	NONE	OFF
3	C	ON	NONE	(OFF)
4	D	ON	NONE	ON
5	F	ON	NONE	(ON)
6	J	ON	OFF	ON
7	K	ON	OFF	(ON)
8	L	(ON)	OFF	(ON)

SPECIAL CIRCUITS

	2 & 3	2 & 3, 5 & 4	5 & 4
H*	2 & 3	2 & 3, 5 & 4	5 & 4
G*	2 & 3, 5 & 6	2 & 3	OFF
S	2 & 3, 5 & 6	2 & 3	1 & 2
M*	(2 & 3, 5 & 6)	2 & 3	OFF
R	(2 & 3, 5 & 6)	2 & 3	1 & 2
E*	5 & 6	5 & 3	5 & 1

*Jumper between terminals 2 & 5 for circuits H, G, & M are specified in selection 4. External jumper between terminals 2 & 4 for circuit E are provided by customer. Circuit E may be used for SP OFF-ON-ON circuit.

3 RATING⁴

1 .4VA @ 28VDC Resistive
 B 15A 24V
 C 20A 18V
 D 20A 12V
 E 20A 14V, 10A 14VT (circuit 1, 4, A & D only)
 F 10A 14V, 6A 14VT (circuit G only)
 M .4VA/20A 12V
 N .4VA/15A 24V

4 TERMINATION/BASE STYLE

8 term	10 term	Termination	Jumper
1	2	.250 TAB (QC) no barriers	No
A	B	.250 TAB (QC) with barriers	No
J	K	.250 TAB (QC) no barriers	Yes T2 to 5
3	4	Solder Lug no barriers	No
C	D	Solder Lug	No
5	6	Wire Leads no barriers	No
E	F	Wire Leads	No

Note: Codes J & K for circuits H, G & M.

5 ILLUMINATION & SWITCH SEALING
Lamp #1: above terminals 1 & 4 end of switch.; Lamp #2 above terminals 3 & 6 end of switch. Positive (+) and negative (-) symbols apply to LED lamps only

Sealed	Unsealed	Lamps	Actuator Lens position when Illuminated	Lamp wired to Terminals
S	0	NONE		
A	1	#1	Independent	8+ 7-
B	2	#1	Down	3+ 7-
C	3	#2	Up	3+ 7-
D	4	#1	Down	3+ 7-
E	5	#1	Down	1+ 7-
F	6	#1	Up	1+ 7-
G	7	#1	Independent	3+ 7-
H	Z	#2	Up	3+ 6-
U	Y	#1	Independent	8+ 7-
		#2	Up	3+ 7-
		#2	Independent	8+ 7-
		#2	Independent	8+ 7-
		#2	Independent	10+ 9-

Selections for Single Pole Switches Only:

J	8	#1	Down	3+ 8-
		#2	Independent	6+ 7-
K	W	#1	Independent	8+ 7-
		#2	Independent	6+ 7-

Selections for Double Pole Switches Only:

L	9	#1	Down	3+ 6-
M	R	#2	Up	3+ 6-
N	T	#1	Down	3+ 6-
P	V	#1	Down	1+ 4-
		#2	Up	1+ 4-
		#2	Up	3+ 6-

6,7 LAMP (same coding for both selections)
Selection 6: above terminals 1 & 4; Selection 7: above terminals 3 & 6

No lamp	0	2 250VAC	6 12V superbright Green	7 18V superbright Red	8 24V superbright Red
Neon	1 125VAC	5 6V			
Incandescent LED*	4 3V				
	Red	Amber			
2VDC	A	L	F	R	
6VDC	B	M	G	S	
12VDC	C	N	H	T	
24VDC	D	P	J	V	

* Consult factory for "daylight bright" LED options. Typical current draw for LED is 20ma.

8 FLUSH BRACKET COLOR¹, PANEL SEAL

	Black	White	Gray
No Seal	B	W	G
One Seal	C	Y	H

9 ACTUATOR

No Actuator	0
Contura IV, left orientation	E
Contura IV, left orientation, laser etched	T
Contura IV, right orientation	F
Contura IV, right orientation, laser etched	R

Actuator orientation above terminals:

10 LENS

0 - No Actuator	Z - No Lens	Green	Red	Blue	
Clear	White	Amber			
1	6	B	G	M	T
2	7	C	H	N	U
3	8	D	J	P	V
4	9	E	K	R	W
5	A	F	L	S	Y

Lens color for LEDs must be clear, white, or match color of LED. Green or blue lenses are not recommended with Neon lamps.

11 ACTUATOR COLOR^{1,5,6}

No Actuator 0 Black C Gray H Red S White Y Nickel D Pewter E

12 ACTUATOR LENS OR BODY LEGENDS²

11 ON	12 OFF	13 I	14 O
OFF	ON	O	I
15 OO	16 OO	17 OI	18 IO
F N	F N		
F	F		

For additional legend options & codes, visit us at www.carlingtech.com.

13 LEGEND ORIENTATION

0 No legend (used with codes 11-18 in selection 12)
 1 Orientation 1
 2 Orientation 2
 3 Orientation 3
 4 Orientation 4

14 ACTUATOR LENS LEGEND
00 No legend this location / no actuator (used with codes 11-18 in selection 12) Selection 14 required when switch requires two legends. If the two legends consist of one lens and one body legend, lens legend must be specified in selection 12; body legend specified in selection 14. For legend options & codes, visit us at www.carlingtech.com.

- Notes:
- Consult factory to verify horsepower rating for your particular circuit choice.
 - Custom colors are available. Consult factory.
 - White imprinting is standard on black actuators; Black imprinting is standard on white, red and gray actuators; Custom colors are available, consult factory.
 - Gloss brow is on left side of E actuator and right side of F actuator.
 - Additional ratings available. See page 20.
 - Laser etched rocker only available with lens code Z & actuator colors black, nickel or pewter.
 - Pewter and nickel colors only available with laser etched actuator.

V	1	D	A	B	T	O	B	G	P	C	00	0	00
1 Series	2 Circuit	3 Rating	4 Termination	5 Illumination	6 Lamp	7 Lamp	8 Bracket	9 Actuator	10 Lens	11 Color	12 Legend	13 Legend Orientation	14 Actuator Lens Legend

1 SERIES

V

2 CIRCUIT

Terminal Connections as viewed from bottom of switch: () - momentary

8 terminal 10 terminal
 8 - -7 8 - -7
 1 - -4 1 - -4
 2 - -5 2 - -5
 3 - -6 3 - -6
 10 - -9

SP - single pole - uses terminals 1, 2 & 3.
 DP - double pole uses terminals 1, 2, 3, 4, 5 & 6.
 Terminals 7, 8, 9 & 10 for lamp circuit only.

Position:	DP	1	2	3
1	A	ON	NONE	OFF
2	B	(ON)	NONE	OFF
3	C	ON	NONE	(OFF)
4	D	ON	NONE	ON
5	F	ON	NONE	(ON)
6	J	ON	OFF	ON
7	K	ON	OFF	(ON)
8	L	(ON)	OFF	(ON)

SPECIAL CIRCUITS

	2 & 3	2 & 3, 5 & 6	5 & 4
H*	2 & 3	2 & 3, 5 & 6	5 & 4
G*	2 & 3, 5 & 6	2 & 3	OFF
S	2 & 3, 5 & 6	2 & 3	1 & 2
M*	(2 & 3, 5 & 6)	2 & 3	OFF
R	(2 & 3, 5 & 6)	2 & 3	1 & 2
E*	5 & 6	5 & 3	5 & 1

*Jumper between terminals 2 & 5 for circuits H, G, & M are specified in selection 4. External jumper between terminals 2 & 4 for circuit E are provided by customer. Circuit E may be used for SP OFF-ON-ON circuit.

3 RATING⁴

1 .4VA @ 28VDC Resistive
 B 15A 24V
 C 20A 18V
 D 20A 12V
 E 20A 14V, 10A 14VT (circuit 1, 4, A & D only)
 F 10A 14V, 6A 14VT (circuit G only)
 M .4VA/20A 12V
 N .4VA/15A 24V

4 TERMINATION/BASE STYLE

8 term	10 term	Termination	Jumper
1	2	.250 TAB (QC) no barriers	No
A	B	.250 TAB (QC) with barriers	No
J	K	.250 TAB (QC) no barriers	Yes T2 to 5
3	4	Solder Lug no barriers	No
C	D	Solder Lug	No
5	6	Wire Leads no barriers	No
E	F	Wire Leads	No

Note: Codes J & K for circuits H, G & M.

5 ILLUMINATION & SWITCH SEALING

Lamp #1: above terminals 1 & 4 end of switch.; Lamp #2 above terminals 3 & 6 end of switch. Positive (+) and negative (-) symbols apply to LED lamps only

Sealed	Unsealed	Lamps	Actuator Lens position when Illuminated	Lamp wired to Terminals
S	0	NONE		
A	1	#1	Independent	8+ 7-
B	2	#1	Down	3+ 7-
C	3	#2	Up	3+ 7-
D	4	#1	Down	3+ 7-
E	5		Down	1+ 7-
F	6	#1	Up	1+ 7-
G	7		Up	3+ 7-
H	Z	#1	Independent	8+ 7-
U	Y	#1	Independent	8+ 7-
			Independent	10+ 9-

Selections for Single Pole Switches Only:

J	8	#1	Down	3+ 8-
			Independent	6+ 7-
K	W	#1	Independent	8+ 7-
			Independent	6+ 7-

Selections for Double Pole Switches Only:

L	9	#1	Down	3+ 6-
M	R	#2	Up	3+ 6-
N	T	#1	Down	3+ 6-
			Down	1+ 4-
P	V	#1	Up	1+ 4-
			Up	3+ 6-

6,7 LAMP (same coding for both selections)

Selection 6: above terminals 1 & 4; Selection 7: above terminals 3 & 6

No lamp	1 125VAC	2 250VAC	6 12V superbright	7 18V superbright	8 24V superbright
0	1	2	6	7	8
Neon	125VAC	250VAC	12V	18V	24V
Incandescent	4 3V	5 6V	Green	Red	Red
LED*	Red	Amber	superbright Green	superbright Red	superbright Red
2VDC	A	L	F	R	S
6VDC	B	M	G	T	T
12VDC	C	N	H	V	V
24VDC	D	P	J	V	V

* Consult factory for "daylight bright" LED options. Typical current draw for LED is 20ma.

8 FLUSH BRACKET COLOR¹, PANEL SEAL

No Seal	Black	White	Gray
0	B	W	G
One Seal	C	Y	H

9 ACTUATOR

No Actuator	0
Contura V	G
Contura V, laser etched	P

10 LENS

Lens color for LEDs must be clear, white, or match color of LED. Lens style & location: Green or blue lenses are not recommended with Neon lamps. #1/ #2

0 - No Actuator	Z - No Lens	Clear	White	Amber	Green	Red	Blue
1	6	B	G	M	T	bar	
2	7	C	H	N	U	bar/bar	
3	8	D	J	P	V	oval	
4	9	E	K	R	W	oval/bar	
5	A	F	L	S	Y	oval/oval	

11 ACTUATOR COLOR^{1,3,3}

No Actuator 0 Black C Gray H Red S White Y Nickel D Pewter E

12 ACTUATOR LENS OR BODY LEGENDS^{2,6}

11 ON	12 OFF	13 I	14 O
OFF	ON	O	I
15 O O	16 O O	17 O I	18 I O
F N	F N		
F	F		

For additional legend options & codes, visit us at www.carlingtech.com.

13 LEGEND ORIENTATION

0 No legend (used with codes 11-18 in selection 12)
 1 Orientation 1
 2 Orientation 2
 3 Orientation 3
 4 Orientation 4

14 ACTUATOR LENS LEGEND

00 No legend this location / no actuator (used with codes 11-18 in selection 12) Selection 14 required when switch requires two legends. If the two legends consist of one lens and one body legend, lens legend must be specified in selection 12; body legend specified in selection 14. For legend options & codes, visit us at www.carlingtech.com.

- Notes:
- Consult factory to verify horsepower rating for your particular circuit choice.
 - Custom colors are available. Consult factory.
 - White imprinting is standard on black actuators; Black imprinting is standard on white, red and gray actuators; Custom colors are available, consult factory.
 - Laser Etched rocker only available with lens code Z & actuator colors black, nickel or pewter.
 - Additional ratings available. See page 20.
 - Nickel and Pewter colors only available with laser etched actuator. Consult factory for laser etched lens callout.

V 1 D A S W O B — J Z E 00 — 0

1 Series 2 Circuit 3 Rating 4 Termination Illumination Lock 5 Lamp 6 Bracket 7 Actuator 8 Lens 9 Function 10 Legend 11 Legend 12 Legend 13 Legend Orientation

1 SERIES
V

2 CIRCUIT³
Terminal Connections as viewed from bottom of switch:

8 terminal	10 terminal	() - momentary
8 - -7	8 - -7	SP - single pole - uses terminals 1, 2 & 3.
1 - -4	1 - -4	DP - double pole uses terminals 1, 2, 3, 4, 5 & 6.
2 - -5	2 - -5	Terminals 7 & 8 for lamp circuit only.
3 - -6	3 - -6	Terminals 9 & 10 are not used with locking style switches.
10 - -9	10 - -9	

Position:

SP	DP	2 & 3, 5 & 6	1	2	3
1	A	ON	Connected	NONE	OFF
4	D	ON	Terminals	NONE	ON
6	J	ON	1 & 2, 4 & 5	OFF	ON
7	K	ON		OFF	(ON)
8	L	(ON)		OFF	(ON)
9	N	OFF		NONE	ON

3 RATING⁴

1 .4VA @ 28VDC Resistive
B 15A 24V
C 20A 18V
D 20A 12V
E 20A 14V, 10A 14VT (circuit 1, 4, A & D only)
F 10A 14V, 6A 14VT (circuit G only)
M .4VA/20A 12V
N .4VA/15A 24V

4 TERMINATION/BASE STYLE

8 term	10 term	Termination	Jumper
1	2	.250 TAB (QC) no barriers	No
A	B	.250 TAB (QC) with barriers	No
J	K	.250 TAB (QC) no barriers	Yes T2 to 5
3	4	Solder Lug no barriers	No
C	D	Solder Lug	No
5	6	Wire Leads no barriers	No
E	F	Wire Leads	No

Note: Codes J & K for circuits H, G & M.

5 ILLUMINATION & SWITCH SEALING

Lamp #1: above terminals 1 & 4 end of switch.; Lamp #2 above terminals 3 & 6 end of switch. Positive (+) and negative (-) symbols apply to LED lamps only

Sealed	Unsealed	Lamps	Actuator Lens position when Illuminated	Lamp wired to Terminals
S	0	NONE		
C	3	# 2	Up	3+ 7-
H	Z	# 2	Independent	8+ 7-

Selections for Double Pole Switches Only:

M	R	# 2	Up	3+ 6-
---	---	-----	----	-------

6 LOCK

Lock above terminals 1 & 4 end of switch.

W	low profile lock	Y ⁶	high profile lock
---	------------------	----------------	-------------------

- Notes:
- Consult factory to verify horsepower rating for your particular circuit choice.
 - Custom colors are available. Consult factory.
 - White imprinting is standard on black actuators; Black imprinting is standard on white, red and gray actuators; Custom colors are available, consult factory.
 - Only available with 3 position circuits. Center OFF and special circuits only available with center position lock function.
 - Additional ratings available. See page 20.
 - Located at T3-6 end of switch.
 - Contura V style only.

7 LAMP
Lamp above terminals 3 & 6 end of switch

No lamp	0	1 125VAC	2 250VAC	6 12V superbright Green	7 18V superbright Red	8 24V superbright Red
Neon	1	4 3V	5 6V			
Incandescent LED*		Red	Amber			
2VDC	A	L	F			
6VDC	B	M	G			
12VDC	C	N	H			
24VDC	D	P	J			

8 FLUSH BRACKET COLOR¹, PANEL SEAL

No Seal	Black	White	Gray
One Seal	B	W	H
	C	Y	

9 HARD SURFACE ACTUATOR

CONTURA IV:

Orientation	Black	Grey	Red	White
Left	J	K	L	M
Right	N	P	R	S

Actuator orientation above terminals: 3,6 1,4

CONTURA V:

Orientation	Black	Grey	Red	White
	U	V	W	Y

Actuator orientation above terminals: 3,6 1,4

10 LENS⁵

Z - No Lens

Clear	White	Amber	Green	Red	Blue
A	B	C	D	E	F
G	H	J	K	L	M

Lens color for LEDs must be clear, white, or match color of LED. Green or blue lenses are not recommended with Neon lamps.

F bar lens
M oval lens

11 ACTUATOR LOCK FUNCTION AND COLOR¹

Lock Color	Up	Down	Up & Down	Center ³
Match Actuator	A	H	R	1
Black	B	J	S	2
White	C	K	T	3
Red	D	L	V	4
Safety Orange	E	M	W	5
Gray	F	G	N	6

12 ACTUATOR LENS OR BODY LEGEND²

00 - No Legend

21	22	23	24
OFF	ON	O	I
25	26	27	28
O	O	O	I
F	N		

For additional legend options & codes, visit us at www.carlingtech.com.

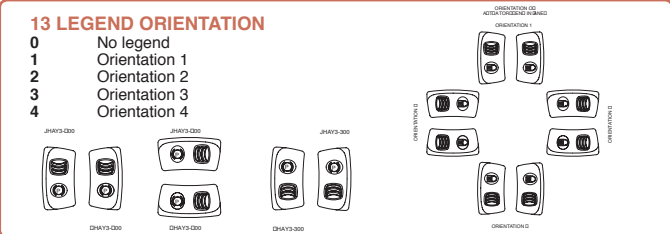

V 1 D B G N T B - H A 7 C B AC - 1 00

1 Series 2 Circuit 3 Rating 4 Termination Illumination 5 Lamp 6 Lamp 7 Lamp 8 Bracket 9 Actuator 10 Lens 11 Lens 12 Color 13 Insert Color 14 Actuator Lens 15 Legend Orientation 16 Actuator Lens Legend

1 SERIES

V

2 CIRCUIT

Terminal Connections as viewed from bottom of switch: () - momentary
 8 terminal 10 terminal
 8 - - 7 8 - - 7
 1 - - 4 1 - - 4
 2 - - 5 2 - - 5
 3 - - 6 3 - - 6
 10 - - 9

SP - single pole - uses terminals 1, 2 & 3.
 DP - double pole uses terminals 1, 2, 3, 4, 5 & 6.
 Terminals 7, 8, 9 & 10 for lamp circuit only.

Position:

Position:	DP	1	2	3
SP		2 & 3, 5 & 6	Connected Terminals	1 & 2, 4 & 5
1	A	ON	NONE	OFF
2	B	(ON)	NONE	OFF
3	C	ON	NONE	(OFF)
4	D	ON	NONE	ON
5	F	ON	NONE	(ON)
6	J	ON	OFF	ON
7	K	ON	OFF	(ON)
8	L	(ON)	OFF	(ON)

SPECIAL CIRCUITS

	2 & 3	2 & 3, 5 & 4	5 & 4
H*	2 & 3	2 & 3, 5 & 4	5 & 4
G*	2 & 3, 5 & 6	2 & 3	OFF
S*	2 & 3, 5 & 6	2 & 3	1 & 2
M*	(2 & 3, 5 & 6)	2 & 3	OFF
R*	(2 & 3, 5 & 6)	2 & 3	1 & 2
E*	5 & 6	5 & 3	5 & 1

*Jumper between terminals 2 & 5 for circuits H, G, & M are specified in selection 4.
 External jumper between terminals 2 & 4 for circuit E are provided by customer. Circuit E may be used for SP OFF-ON-ON circuit.

3 RATING³

- 1 .4VA @ 28VDC Resistive
- B 15A 24V
- C 20A 18V
- D 20A 12V
- E 20A 14V, 10A 14VT (circuit 1, 4, A & D only)
- F 10A 14V, 6A 14VT (circuit G only)
- M .4VA/20A 12V
- N .4VA/15A 24V

4 TERMINATION/BASE STYLE

8 term	10 term	Termination	Jumper
1	2	.250 TAB (QC) no barriers	No
A	B	.250 TAB (QC) with barriers	No
J	K	.250 TAB (QC) no barriers	Yes T2 to 5
3	4	Solder Lug no barriers	No
C	D	Solder Lug	No
5	6	Wire Leads no barriers	No
E	F	Wire Leads	No

5 ILLUMINATION & SWITCH SEALING

Lamp #1: above terminals 1 & 4 end of switch.; Lamp #2 above terminals 3 & 6 end of switch. Positive (+) and negative (-) symbols apply to LED lamps only

Sealed	Unsealed	Lamps	Actuator Lens position when Illuminated	Lamp wired to Terminals
S	0	NONE		
A	1	# 1	Independent	8+ 7-
B	2	# 1	Down	3+ 7-
C	3	# 2	Up	3+ 7-
D	4	# 1	Down	3+ 7-
E	5	&# 2	Down	1+ 7-
F	6	# 1	Up	1+ 7-
F	6	&# 2	Up	3+ 7-
G	7	# 1	Independent	8+ 7-
H	Z	# 2	Up	3+ 6-
U	Y	# 1	Independent	8+ 7-
		&# 2	Independent	10+ 9-
Selections for Single Pole Switches Only:				
J	8	# 1	Down	3+ 8-
		&# 2	Independent	6+ 7-
K	W	# 1	Independent	8+ 7-
		&# 2	Independent	6+ 7-
Selections for Double Pole Switches Only:				
L	9	# 1	Down	3+ 6-
M	R	# 2	Up	3+ 6-
N	T	# 1	Down	3+ 6-
		&# 2	Down	1+ 4-
P	V	# 1	Up	1+ 4-
		&# 2	Up	3+ 6-

6,7 LAMP (same coding for both selections)

Selection 6: above terminals 1 & 4; Selection 7: above terminals 3 & 6

No lamp	1 125VAC	2 250VAC	6 12V superbright	7 18V superbright	8 24V
Neon	1 125VAC	2 250VAC	6 12V superbright	7 18V superbright	8 24V
Incandescent	4 3V	5 6V	6 12V superbright	7 18V superbright	8 24V
LED*			6 12V superbright	7 18V superbright	8 24V
	Red	Amber	Green	Red	
2VDC	A	L	F	R	
6VDC	B	M	G	S	
12VDC	C	N	H	T	
24VDC	D	P	J	V	

* Consult factory for "daylight bright" LED options. Typical current draw for LED is 20ma.

8 FLUSH BRACKET COLOR¹; PANEL SEAL

	Black	White	Gray
No Seal	B	W	G
One Seal	C	Y	H

9 ACTUATOR

0 No Actuator	H High Insert	L Low Insert
---------------	---------------	--------------

10,11 LENS⁴

Lens color for LEDs must be clear, white, or match color of LED. Green or blue lenses are not recommended with Neon lamps.

0 - No Actuator	Z - No Lens				
Clear	White	Amber	Green	Red	Blue
-	7	C	H	N	U
3	-	D	J	P	V
4	-	E	K	R	W
-	A	F	L	S	Y

Bar Lens Translucent
 Bar Lens Transparent
 Oval Lens Transparent
 Oval Lens Translucent

12 ACTUATOR COLOR

C Black	H Gray	S Red	Y White
---------	--------	-------	---------

13 INSERT COLOR

B Black	N Bright Nickel Plated
C Bright Chrome Plated	S Satin Chrome Plated
D Satin Chrome Painted	T Satin Nickel Plated
	W White

14 ACTUATOR LENS OR BODY LEGENDS²

00 - No Legend this location/No actuator	
11 ON OFF	12 OFF ON
13 I O	14 O I
15 O O	16 O O
F N	F N
F F	F F

For additional legend options & codes, see pages 54-65 of the Carling Transportation catalog

15 LEGEND ORIENTATION

0	No legend (used with codes 11-18 in selection 12)
1	Orientation 1
2	Orientation 2
3	Orientation 3
4	Orientation 4



16 ACTUATOR LENS LEGEND

00 No legend this location / no actuator (used with codes 11-18 in selection 12) Selection 14 required when switch requires two legends. If the two legends consist of one lens and one body legend, lens legend must be specified in selection 12; body legend specified in selection 14. For legend options & codes, visit us at www.carlingtech.com.

Notes:

- 1 Consult factory to verify horsepower rating for your particular circuit choice.
- 2 Custom colors are available. Consult factory.
- 3 White imprinting is standard on black actuators; Black imprinting is standard on white, red and gray actuators; Custom colors are available, consult factory.
- 4 Additional ratings available. See page 20.

V 1 D A B T O B — Z R C 00 — 0 00

1 Series 2 Circuit 3 Rating 4 Termination Illumination 5 Lamp 6 Lamp 7 Lamp 8 Bracket 9 Actuator 10 Lens 11 Color 12 Legend 13 Legend Orientation 14 Actuator Lens Legend

1 SERIES
V

2 CIRCUIT
Terminal Connections as viewed from bottom of switch: () - momentary

8 terminal 10 terminal
 8 - -7 8 - -7
 1 - -4 1 - -4
 2 - -5 2 - -5
 3 - -6 3 - -6
 10 - -9

SP - single pole - uses terminals 1, 2 & 3.
 DP - double pole uses terminals 1, 2, 3, 4, 5 & 6.
 Terminals 7, 8, 9 & 10 for lamp circuit only.

Position:

	DP	2 & 3, 5 & 6	Connected Terminals	1 & 2, 4 & 5
1	A	ON	NONE	OFF
2	B	(ON)	NONE	OFF
3	C	ON	NONE	(OFF)
4	D	ON	NONE	ON
5	F	ON	NONE	(ON)
6	J	ON	OFF	ON
7	K	ON	OFF	(ON)
8	L	(ON)	OFF	(ON)

SPECIAL CIRCUITS

	2 & 3	2 & 3, 5 & 4	5 & 4
H*	2 & 3	2 & 3, 5 & 4	5 & 4
G*	2 & 3, 5 & 6	2 & 3	OFF
S	2 & 3, 5 & 6	2 & 3	1 & 2
M*	(2 & 3, 5 & 6)	2 & 3	OFF
R	(2 & 3, 5 & 6)	2 & 3	1 & 2
E*	5 & 6	5 & 3	5 & 1

*Jumper between terminals 2 & 5 for circuits H, G, & M are specified in selection 4. External jumper between terminals 2 & 4 for circuit E are provided by customer. Circuit E may be used for SP OFF-ON-ON circuit.

3 RATING⁴

1 .4VA @ 28VDC Resistive
B 15A 24V
C 20A 18V
D 20A 12V
E 20A 14V, 10A 14VT (circuit 1, 4, A & D only)
F 10A 14V, 6A 14VT (circuit G only)
M .4VA/20A 12V
N .4VA/15A 24V

4 TERMINATION/BASE STYLE

8 term	10 term	Termination	Jumper
1	2	.250 TAB (QC) no barriers	No
A	B	.250 TAB (QC) with barriers	No
J	K	.250 TAB (QC) no barriers	Yes T2 to 5
3	4	Solder Lug no barriers	No
C	D	Solder Lug	No
5	6	Wire Leads no barriers	No
E	F	Wire Leads	No

Note: Codes J & K for circuits H, G & M.

5 ILLUMINATION & SWITCH SEALING
 Lamp #1: above terminals 1 & 4 end of switch.; Lamp #2 above terminals 3 & 6 end of switch. Positive (+) and negative (-) symbols apply to LED lamps only

Sealed	Unsealed	Lamps	Actuator Lens position when Illuminated	Lamp wired to Terminals
S	0	NONE		
A	1	#1	Independent	8+ 7-
B	2	#1	Down	3+ 7-
C	3	#2	Up	3+ 7-
D	4	#1	Down	3+ 7-
E	5	#1	Down	1+ 7-
F	6	#1	Up	1+ 7-
G	7	#2	Up	3+ 7-
H	Z	#1	Independent	8+ 7-
U	Y	#1	Independent	8+ 7-
J	8	#1	Down	10+ 9-
K	W	#2	Independent	3+ 8-
L	9	#1	Independent	6+ 7-
M	R	#1	Independent	8+ 7-
N	T	#1	Independent	3+ 6-
P	V	#1	Independent	1+ 4-
		#2	Independent	1+ 4-
		#2	Independent	3+ 6-

Selections for Single Pole Switches Only:
J 8 #1 Down 3+ 8-
K W #1 Independent 6+ 7-
L 9 #1 Independent 8+ 7-
M R #1 Independent 3+ 6-
N T #1 Independent 1+ 4-
P V #1 Independent 1+ 4-
 Selections for Double Pole Switches Only:
L 9 #1 Down 3+ 6-
M R #2 Up 3+ 6-
N T #1 Down 3+ 6-
P V #1 Down 1+ 4-
 #2 Up 1+ 4-
 #2 Up 3+ 6-

6,7 LAMP (same coding for both selections)
 Selection 6: above terminals 1 & 4; Selection 7: above terminals 3 & 6

No lamp	0	1 125VAC	2 250VAC	6 12V superbright Green	7 18V superbright Red	8 24V
Incandescent LED*	4 3V	5 6V				
2VDC	A	L	F	R		
6VDC	B	M	G	S		
12VDC	C	N	H	T		
24VDC	D	P	J	V		

* Consult factory for "daylight bright" LED options. Typical current draw for LED is 20ma.

8 FLUSH BRACKET COLOR¹, PANEL SEAL

	Black	White	Gray
No Seal	B	W	G
One Seal	C	Y	H

9 ACTUATOR
 No Actuator 0
 Contura VII Z

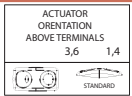

10 LENS
 Lens color for LEDs must be clear, white, or match color of LED. Green or blue lenses are not recommended with Neon lamps.

0 - No Actuator Z - No Lens

White	Amber	Green	Red	Blue	Lens style & location
6	B	G	M	T	
7	C	H	N	U	
8	D	J	P	V	
9	E	K	R	W	
A	F	L	S	Y	
1	2	3	4	5	

11 ACTUATOR COLOR/THUMB PRINT COLOR¹

O	N/A - No Actuator	C	Black/Black
H	Grey/Black	S	Red/Black
Y	White/Black		

12 ACTUATOR LENS LEGENDS^{2,4}

11 ON	12 OFF	13 I	14 O
OFF	ON	O	I
15 O O	16 O O	17 O I	18 I O
F N	F N		
F	F		

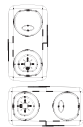

For additional legend options & codes, visit us at www.carlingtech.com.

13 LEGEND ORIENTATION

0 No legend (used with codes 11-18 in selection 12)
 1 Orientation 1
 2 Orientation 2
 3 Orientation 3
 4 Orientation 4

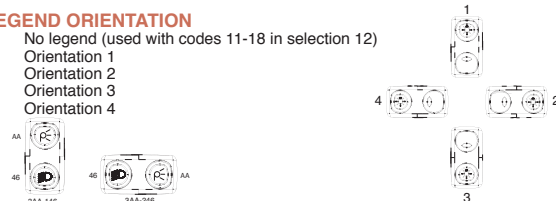

14 ACTUATOR LENS LEGEND
 00 No legend this location / no actuator (used with codes 11-18 in selection 12) Selection 14 required when switch requires two legends. If the two legends consist of one lens and one body legend, lens legend must be specified in selection 12; body legend specified in selection 14. For legend options & codes, visit us at www.carlingtech.com.

Notes:
 Consult factory to verify horsepower rating for your particular circuit choice.
 1 Custom colors are available. Consult factory.
 2 White imprinting is standard on black actuators; Black imprinting is standard on white, red and gray actuators; Custom colors are available, consult factory.
 3 Additional ratings available. See page 20.
 4 Legends available for lighted oval lens version only



1 SERIES
V

2 CIRCUIT
Terminal Connections as viewed () - momentary
8 terminal 10 terminal
8- -7 8- -7
1- -4 1- -4
2- -5 2- -5
3- -6 3- -6
10- -9

SP - single pole - uses terminals 1, 2 & 3.
DP - double pole uses terminals 1, 2, 3, 4, 5 & 6.
Terminals 7, 8, 9 & 10 for lamp circuit only.

Position:

SP	DP	2 & 3, 5 & 6	Connected Terminals	1 & 2, 4 & 5
1 A ON	1 A ON	1 ON	1 NONE	1 OFF
2 B ON	2 B ON	2 (ON)	2 NONE	2 OFF
3 C ON	3 C ON	3 (ON)	3 NONE	3 (OFF)
4 D ON	4 D ON	4 (ON)	4 NONE	4 ON
5 F ON	5 F ON	5 (ON)	5 NONE	5 (ON)
6 J ON	6 J ON	6 (ON)	6 OFF	6 ON
7 K ON	7 K ON	7 (ON)	7 OFF	7 (ON)
8 L ON	8 L ON	8 (ON)	8 OFF	8 (ON)

SPECIAL CIRCUITS

	2 & 3	2 & 3, 5 & 6	2 & 3, 5 & 6	2 & 3, 5 & 6	2 & 3, 5 & 6	5 & 6
H*	2 & 3	2 & 3, 5 & 6	2 & 3	2 & 3	2 & 3	5 & 6
G*	2 & 3	2 & 3, 5 & 6	2 & 3	2 & 3	2 & 3	5 & 6
S*	2 & 3	2 & 3, 5 & 6	2 & 3	2 & 3	2 & 3	5 & 6
M*	2 & 3	2 & 3, 5 & 6	2 & 3	2 & 3	2 & 3	5 & 6
E*	2 & 3	2 & 3, 5 & 6	2 & 3	2 & 3	2 & 3	5 & 6

* Jumper between terminals 2 & 5 for circuits H, G, & M are specified in Selection 4.
External jumper between terminals 2 & 4 for circuit E are provided by customer. Circuit E may be used for SP OFF-ON-ON circuit.

3 RATING⁴

1	.4VA @ 28VDC Resistive
B	15A 24V
C	20A 18V
D	20A 12V
E	20A 14V, 10A 14VT (circuit 1, 4, A & D only)
F	10A 14V, 6A 14VT (circuit G only)
M	.4VA/20A 12V
N	.4VA/15A 24V

4 TERMINATION/BASE STYLE

8 term	10 term	Termination	Jumper
1	2	250 TAB (QC) no barriers	No
A	B	250 TAB (QC) with barriers	No
J	K	250 TAB (QC) no barriers	Yes T2 to 5
3	4	Solder Lug no barriers	No
C	D	Solder Lug	No
5	6	Wire Leads no barriers	No
E	F	Wire Leads	No

Note: Codes J & K for circuits H, G & M.

5 ILLUMINATION & SWITCH SEALING
Lamp #1: above terminals 1 & 4 end of switch.; Lamp #2 above terminals 3 & 6 end of switch. Positive (+) and negative (-) symbols apply to LED lamps only

Sealed	Unsealed	Lamps	Actuator Lens position when Illuminated	Terminals
S	0	NONE		
A	1	#1	Independent	8+ 7-
B	2	#1	Down	3+ 7-
C	3	#2	Up	3+ 7-
D	4	#1	Down	3+ 7-
E	5		Down	1+ 7-
F	6	#1	Up	1+ 7-
G	7		Up	3+ 7-
H	Z	#1	Independent	8+ 7-
U	Y	#1	Independent	8+ 7-
			Independent	10+ 9-
J	8	#1	Down	3+ 8-
K	W		Independent	6+ 7-
		#1	Independent	8+ 7-
			Independent	6+ 7-
L	9	#1	Down	3+ 6-
M	R	#2	Up	3+ 6-
N	T	#1	Down	3+ 6-
P	V		Down	1+ 4-
		#1	Up	1+ 4-
			Up	3+ 6-

6,7 LAMP (same coding for both selections)
Selection 6: above terminals 1 & 4; Selection 7: above terminals 3 & 6

No lamp	0				
Neon ⁵	1 125VAC	2 250VAC			
Incandescent	4 3V	5 6V	6 12V superbright	7 18V superbright	8 24V Red
LED*			Green	Red	
2VDC	A Red	L Amber	F Green	R Red	
6VDC	B	M	G	S	
12VDC	C	N	H	T	
24VDC	D	P	J	V	

* Consult factory for "daylight bright" LED options. Typical current draw for LED is 20ma.

8 BRACKET COLOR¹, PANEL SEAL (EXTERNAL FOAM GASKET)

# of gaskets	X & XI w/Flush Bracket	2	X, XI, XII w/Raised Bracket	0	1
Black	B	C	D	1	4
White	W	Y	Z	2	5
Gray	G	H	J	3	6

9 ACTUATOR

No Actuator	0				
Contura X	1	Black	Gray	White	Red
Contura XI	6	2	7	8	9
Contura XII	J	K	N	M	

Actuator orientation above terminals:
3,6 1,4

10 LENS - ABOVE LAMP #1 TERMINALS^{1,4}
11 LENS - ABOVE LAMP #2 TERMINALS^{3,6}

0 - No Actuator	White	Amber	Green	Red	Blue	Lens Style
3	8	D	J	P	V	Bar
4	9	E	K	R	W	One piece Square
5	A	F	L	S	Y	Two piece Square*
						(w/ clear top protective lens)
2	7	C	H	N	U	Two piece Square*
						(w/ smoke top protective lens)
1	6	B	G	M	T	Two piece Square*
						(w/ white top protective lens)

* All bottom lenses are molded of opaque material. Consult factory for other lens colors. Lens color for LEDs must be clear, white, or match color of LED. Green or blue lenses are not recommended with Neon lamps.

12 ACTUATOR LENS OR BODY LEGEND²

00 - No Legend this location/No actuator

11 ON	12 OFF	13 I	14 O
OFF	ON	O	I
15 O O	16 O O	17 O I	18 I O
F N	N F		
F	F		
21 OFF	22 ON	23 O	24 I
25 O	26 O	27 O	28 I
F	N		
F			

For additional legend options & codes, visit us at www.carlingtech.com.

13 LEGEND ORIENTATION³

0 No legend (used with codes 11-18 in selection 12)

1 Orientation 1
2 Orientation 2
3 Orientation 3
4 Orientation 4

14 ACTUATOR LENS LEGEND

00 No legend this location / no actuator (used with codes 11-18 in selection 12) Selection 14 required when switch requires two legends. If the two legends consist of one lens and one body legend, lens legend must be specified in selection 12; body legend specified in selection 14. For legend options & codes, visit us at www.carlingtech.com.

Notes: Consult factory to verify horsepower rating for your particular circuit choice.
1 Custom colors are available. Consult factory.
2 White imprinting is standard on black actuators; Black imprinting is standard on white, red & gray actuators; Custom colors are available, consult factory.
3 With 2 square lenses, use sel. 12 for lens above lamp 1, & selection 14 for lens above lamp 2.
4 Additional ratings available. See page 20.
5 Not available with Contura XI rockers.

V 1 D A S W O 1 — 1 P B 00 — 0

1 Series 2 Circuit 3 Rating 4 Termination Illumination Lock 5 Lamp 6 Bracket 7 Actuator 8 Lens 9 Function 10 Legend 11 Legend 12 Legend 13 Legend Orientation

1 SERIES
V

2 CIRCUIT
Terminal Connections as viewed from bottom of switch:
8 terminal 10 terminal
8 - -7 8 - -7
1 - -4 1 - -4
2 - -5 2 - -5
3 - -6 3 - -6
10 - -9

() - momentary
SP - single pole - uses terminals 1, 2 & 3.
DP - double pole uses terminals 1, 2, 3, 4, 5 & 6.
Terminals 7, 8, 9 & 10 for lamp circuit only.

Position:

DP	1	2	3
A	ON	Connected	1 & 2, 4 & 5
D	ON	NONE	OFF
J	ON	OFF	ON
N	OFF	NONE	ON

SPECIAL CIRCUITS

H*	2 & 3	2 & 3, 5 & 4	5 & 4
G*	2 & 3, 5 & 6	2 & 3	OFF
S	2 & 3, 5 & 6	2 & 3	1 & 2
E*	5 & 6	5 & 3	5 & 1

*Jumper between terminals 2 & 5 for circuits H, G, & M are specified in selection 4. External jumper between terminals 2 & 4 for circuit E are provided by customer. Circuit E may be used for SP OFF-ON-ON circuit.

3 RATING⁴

1 .4VA @ 28VDC Resistive
B 15A 24V
C 20A 18V
D 20A 12V
E 20A 14V, 10A 14VT (circuit 1, 4, A & D only)
F 10A 14V, 6A 14VT (circuit G only)
M .4VA/20A 12V
N .4VA/15A 24V

4 TERMINATION/BASE STYLE

8 term	10 term	Termination	Jumper
1	2	.250 TAB (QC) no barriers	No
A	B	.250 TAB (QC) with barriers	No
J	K	.250 TAB (QC) no barriers	Yes T2 to 5
3	4	Solder Lug no barriers	No
C	D	Solder Lug	No
5	F	Wire Leads no barriers	No
E	F	Wire Leads	No

Note: Codes J & K for circuits H, G & M.

5 ILLUMINATION & SWITCH SEALING
Lamp above terminals 3 & 6 end of switch.
Positive (+) and negative (-) symbols apply to LED lamps only

Sealed	Unsealed	Lamps	Actuator Lens position when Illuminated	Lamp wired to Terminals
S	0	NONE		
C	3	# 2	Up	3+ 7-
H	Z	# 2	Independent	8+ 7-
M	R	# 2	Up	3+ 6-

Selections for Double Pole Switches Only:

6 LOCK
Lock above terminals 1 & 4 end of switch.
W lock

7 LAMP
Lamp above terminals 3 & 6 end of switch

No lamp	0				
Neon	1	125VAC	2	250VAC	
Incandescent	4	3V	5	6V	
LED*		Red		Amber	6 12V superbright Green
		A		L	7 18V superbright Red
2VDC		B		M	8 24V superbright Red
6VDC		C		N	
12VDC		D		P	
24VDC					

* Consult factory for "daylight bright" LED options. Typical current draw for LED is 20ma.

8 RAISED BRACKET COLOR¹, PANEL SEAL (EXTERNAL FOAM GASKET)

No Gasket	1	Black	2	White	3	Gray
One Gasket	4		5		6	

9 HARD SURFACE ACTUATOR

Contura X	1	Black	2	Grey	3	Red	4	White
-----------	---	-------	---	------	---	-----	---	-------

Actuator orientation above terminals: 3,6 1,4

10 LENS - ABOVE LAMP #2 TERMINALS^{3,6}
Z - No Lens

Clear	White	Amber	Green	Red	Blue	Lens Style
3	8	D	J	P	V	Bar
4	9	E	K	R	W	One piece Square
5	A	F	L	S	Y	Two piece Square* (w/ clear top protective lens)
						Two piece Square* (w/ smoke top protective lens)
2	7	C	H	N	U	Two piece Square* (w/ white top protective lens)
1	6	B	G	M	T	

* All bottom lenses are molded of opaque material. Consult factory for other lens colors. Lens color for LEDs must be clear, white, or match color of LED. Green or blue lenses are not recommended with Neon lamps.

11 ACTUATOR LOCK FUNCTION AND COLOR³

Lock Color	Up	Down	Up & Down
Match Actuator	A	H	R
Black	B	J	S
White	C	K	T
Red	D	L	V
Gray	E	M	W
Safety Orange	F	N	Y

12 ACTUATOR LENS OR BODY LEGEND²
00 - No Legend

21	22	23	24
OFF	ON	O	I
25	O	26	O
F	N	27	O
F		28	I

For additional legend options & codes, visit us at www.carlingtech.com.

13 LEGEND ORIENTATION³

0	No legend (used with codes 11-18 in selection 12)
1	Orientation 1
2	Orientation 2
3	Orientation 3
4	Orientation 4

1PM4F-1, MC, 4F, 45, 18K45-2

Notes:
Consult factory to verify horsepower rating for your particular circuit choice.
1 Custom colors are available. Consult factory.
2 White imprinting is standard on black actuators; Black imprinting is standard on white, red and gray actuators; Custom colors are available, consult factory.
3 Located over T1-4 end of switch.
4 Additional ratings available. See page 20.

Reduce inventory levels and cost by stocking actuators and base switches separately.

Contura II, III, IV, V, X, XI, XII Base switches separately: specify **V** with code selections 2-8 in the ordering schemes.

Contura II, III, IV, V Actuator only: VV with code **A** or **C** for selection 9, & with selections 10-14 in the ordering schemes.

Panel Seal: VPS

Contura II, III, IV, V Actuator only: VV with code **A, C, E, G** or **P** for selection 9 & with selections 10-14 in the ordering schemes.

Contura X, XI, XII actuators with lenses separately: VV with code selections 9-14 in the ordering schemes.

Contura X & XI actuators without lenses separately:

VVR 6 1 00 1

1 Actuator Separately 2 Actuator Style/Color 3 Lens Opening 4 Actuator Legend 5 Legend Orientation

1 CONTURA X & XI ACTUATOR SEPARATELY
VVP

2 ACTUATOR STYLE & COLOR

	Black	Gray	White	Red
Contura X	1	2	3	4
Contura XI	6	7	8	9

3 LENS OPENING FOR¹

1	One bar lens	5	square lens on top/ bar lens on bottom (Contura X only)
2	One bar lenses		
3	One square lens		
4	two square lens		

4 ACTUATOR LENS OR BODY LEGEND

00 - No Legend this location

11 ON	12 OFF	13 I	14 O
OFF	ON	O	I
15 O O	16 O O	17 O I	18 I O
F N	N F		
F	F		

For additional legend options & codes, visit us at www.carlingtech.com.

5 LEGEND ORIENTATION¹

0	No legend
1	Orientation 1
2	Orientation 2
3	Orientation 3
4	Orientation 4

Contura X, XI & XII top piece of 2-piece lens separately:

VVT 1

1 Lens Separately 2 Color

1 TOP OF LENS SEPARATELY
VVT

2 COLOR
1 Clear 2 Smoke 3 White

Contura X, XI & XII actuator lens assembly:



1 piece lens/bar lens are positioned the same as bottom lens for assembly, minus the top lens. Lenses snap in from bottom.

Notes:

- 1 If actuator lens opening for 2 bar or 2 square lenses, legend orientation 0, 1, or 2 must be chosen.
- 2 Center of actuator marking not available for Contura XII.
- 3 Legend is not available for bar style lens.
- 4 Not recommended with neon lamps.
- 5 Must also order top piece of 2 piece square lens separately.

Contura XII actuators without lenses separately:

VVP J 1 Z 21 1 00

1 Actuator 2 Style & Color 3 Lens Opening 4 Lens Opening 5 Legend 6 Legend Orientation 7 Legend Orientation

1 CONTURA XII ACTUATOR SEPARATELY
VVP

2 ACTUATOR STYLE & COLOR

J Black K Gray N White M Red

3,4 LENS OPENING FOR

Z No lens 1 Bar lens 2 Square lens

5, 7 LENS OR BODY LEGEND²

00 - No Legend

21 OFF	22 ON	23 O	24 I
25 O	26 O	27 O	28 I
F	N		
F			

For additional legend options & codes, visit us at www.carlingtech.com.

6 LEGEND ORIENTATION³

0	No legend
1	Orientation 1
2	Orientation 2

Contura X, XI & XII actuator lens assembly separately:

VVL 2 1 00 0

1 Lens Separately 2 Lens Style 3 Lens Color 4 Legend 5 Legend Orientation

1 CONTURA X, XI & XII LENS SEPARATELY
VVL

2 LENS STYLE³

1 Bar lens 2 One Piece Square lens 3 Bottom of Two-Piece Square lens⁵

3 TRANSLUCENT LENS COLOR

1 Clear 2 White 3 Amber 4 Green⁴ 5 Red 6 Blue⁴

4 LENS OR BODY LEGEND²

00 - No Legend

21 OFF	22 ON	23 O	24 I
25 O	26 O	27 O	28 I
F	N		
F			

For additional legend options & codes, visit us at www.carlingtech.com.

5 LEGEND ORIENTATION³

0	No legend
1	Orientation 1
2	Orientation 2
3	Orientation 3
4	Orientation 4

Easily integrate Contura products into your system, with Contura Accessories

Contura Connectors

Q.C. SELECTION GUIDE					
COMPANY SERIES	PART NO		WIRE RANGE		ORIENTATION
	PLAIN BRASS	TIN PLATED BRASS	AWG	MM ² (REF)	
PACKARD 58 SERIES	02965580		12	3.0	B
	02965471	12010601	(2)16-14	(2)1.0-2.0	
	02965470		16-14	1.0-2.0	
	02965469	06288318	20-18	.5-.8	
PACKARD METRI-PACK 630 SERIES		12084590	10	5.0	A
		12052224	12	3.0	
		12015870	16-14	1.0-2.0	
		12020035	(2)22-18	(2).5-.8	
	12015832	12015869	20-18	.5-.8	
		12052222	20-22	.35-.5	
AMP 250 SERIES FASTIN-FASTON	60253-1	60253-2	16-12	1.3-3	B
	42100-1	42100-2	(2) 16	(2) 1.3	
	60295-1	60295-2	22-18	.3-.9	

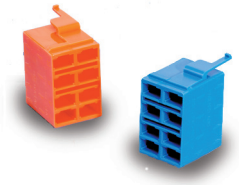

NOTE: Consult Delphi Packard and/or Amp on actual part numbers and availability. AMP is a registered trademark of AMP Inc. Harrisburg, PA. Delphi Packard is a registered trademark of Delphi-Packard Electrical Systems Warren, Ohio

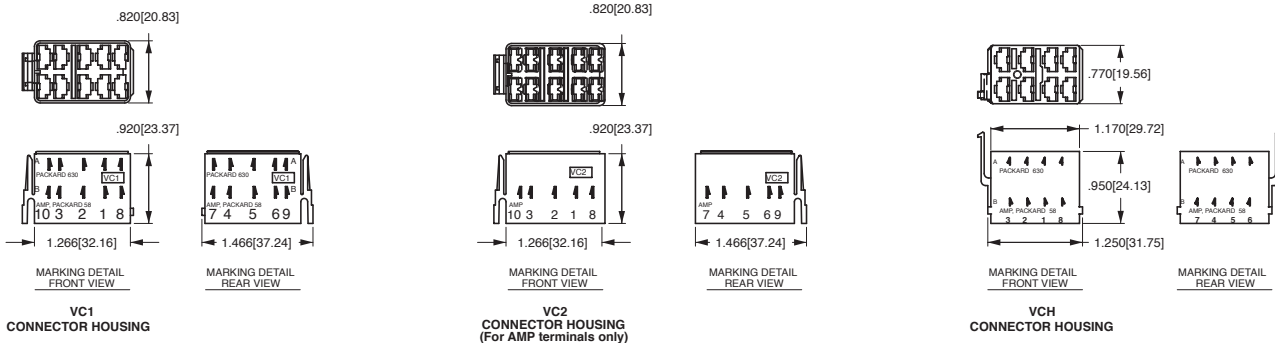

Contura X Boot (P/N VB1-01)



Additional V-Series Ratings

- 1 .4VA @ 28VDC Resistive
- 4 10A 250VAC 1/2 HP, 15A 125 VAC 1/2 HP, No Agency Listings
- 5 10A 250VAC 1/2 HP, 15A 125 VAC 1/2 HP, UL Recognized, CSA Certified
- 6* 15A 125VAC 1/2 HP, 12(2)A 125 VAC μ T85
- 7* 15A 125VAC 1/2 HP, 12(6)A 125 VAC T85
- 8* 10A 250VAC, 15A 125VAC, 1/2 HP 125-250VAC, 12(2)A 250 VAC μ T85
- 9* 10A 250VAC, 15A 125VAC, 1/2 HP 125-250VAC, 12(6)A 250 VAC T85
- B 15A 24V
- C 20A 18V
- D 20A 12V
- E 20A 14V, 10A 14VT (circuits 1, 4, A, & D only)
- F 10A 14V, 6A, 14VT (circuit G only)
- G 20A 6V
- H 20A 3V
- L 15A 125 VAC, 10A 250VAC, 1/2 HP 125-250 VAC; 6A 125 VAC L
- M .4VA/20A 12V (combi-contact)
- (combination gold/silver contacts for borderline dry circuit applications)
- N .4VA/15A 24V (combi-contact)
- (combination gold/silver contacts for borderline dry circuit applications)

Contura II, III, IV & V Actuator Removal Tool (P/N VRT)



NOTES

Consult factory to determine availability for individual circuits and their HP rating.
 * Ratings 6 - 9 are UL, CSA & VDE certified, require terminations A or B for double pole circuits, & are not available with illumination circuits 4, 8, D, J, N, & T or with wire lead or solder lug terminations. Circuits 1, 4, A, D, H, M & E are not available with rating 6 & 8. Rating 7 & 9 only available with circuits 1, 4, A & D. Circuits 2, 3, 5, 7, 8, K, L are 1/2 HP 250VAC only with rating 8. Ratings 6 & 7 must specify lamp code 1 (125VAC neon). Ratings 8 & 9 must specify lamp code 2 (250VAC neon). Rating L available with circuits 1, 4, A & D only.

Contura Mounting Panels Dimensional Specifications: in. [mm]



MOUNTING PANEL
For additional units, add 1.03[26.2] per unit.
For more than 2 V-Series Switches, add middle section. Available in Panel Thicknesses listed below. Consult factory.

MOUNTING PANEL THICKNESS

.062[1.57]	.167[4.75]
.093[2.36]	.250[6.35]
.125[3.17]	.375[9.52]



VMS MOUNTING HOLE



MOUNTING PANEL OPENING (2) UNITS



VME MOUNTING PANEL END



VMM MOUNTING PANEL MIDDLE



VMS MOUNTING PANEL



VM3 MOUNTING PANEL



VM6 MOUNTING PANEL

Contura Hole Plug Dimensional Specifications: in. [mm]



VHP CONTURA II, III HOLE PLUG



VHP CONTURA II, III HOLE PLUG

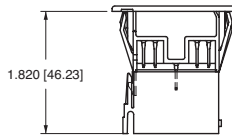

VH1 STANDARD HOLE PLUG (No wing serrations) (With VC1 connector attached)

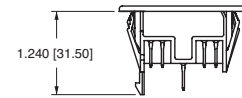

VH2 STANDARD HOLE PLUG (With wing serrations)

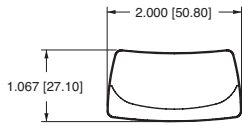

(TYP. FOR VH3 & VH4)

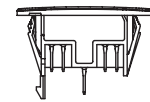

VH3 CONTURA IV HOLE PLUG (No wing serrations)

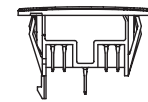

VH4 CONTURA IV HOLE PLUG (With wing serrations)



DETAIL VIEW VH1, VH3 & VH5 HOLE PLUGS (No wing serrations for ease of removal)

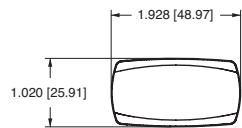

(TYP. FOR VH5 & VH6)



VH5 CONTURA V HOLE PLUG (No wing serrations)

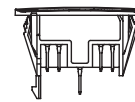

VH6 CONTURA V HOLE PLUG (With wing serrations)



DETAIL VIEW VH2, VH4 & VH6 HOLE PLUGS (With wing serrations)

* Intentionally left blank

* Intentionally left blank

Worldwide Headquarters

Carling Technologies, Inc.
60 Johnson Avenue • Plainville, CT 06062-1177
Phone: (860) 793-9281 • Fax: (860) 793-9231
Email: sales@carlingtech.com • www.carlingtech.com

East Region Sales Office, CT • ersm@carlingtech.com
Midwest Region Sales Office, IL • mrs@carlingtech.com
West Region Sales Office, CA • wrsm@carlingtech.com

Asia-Pacific Headquarters

Carling Technologies, Asia-Pacific Ltd.,
Kowloon, Hong Kong
Int + 852-2737-2277 • Fax: Int + 852-2736-9332
Email: sales@carlingtech.com.hk

Shenzhen, China • shenzhen@carlingtech.com
Shanghai, China • shanghai@carlingtech.com
Pune, India • india@carlingtech.com
Kaohsiung, Taiwan • taiwan@carlingtech.com
Yokohama, Japan • japan@carlingtech.com

Europe / Middle East / Africa Headquarters

Carling Technologies, Ltd.,
Devon, England
Int + 44 1392-364422 • Fax: Int + 44 1392-364477
Email: ltd.sales@carlingtech.com

GmbH, Germany • gmbh@carlingtech.com
SAS, France • sas@carlingtech.com

REV_SW_V_1112



Carling Technologies®

Innovative Designs. Powerful Solutions.

Innovative Designs. Powerful Solutions.

Компания «Life Electronics» занимается поставками электронных компонентов импортного и отечественного производства от производителей и со складов крупных дистрибьюторов Европы, Америки и Азии.

С конца 2013 года компания активно расширяет линейку поставок компонентов по направлению коаксиальный кабель, кварцевые генераторы и конденсаторы (керамические, пленочные, электролитические), за счёт заключения дистрибьюторских договоров

Мы предлагаем:

- Конкурентоспособные цены и скидки постоянным клиентам.
- Специальные условия для постоянных клиентов.
- Подбор аналогов.
- Поставку компонентов в любых объемах, удовлетворяющих вашим потребностям.
- Приемлемые сроки поставки, возможна ускоренная поставка.
- Доставку товара в любую точку России и стран СНГ.
- Комплексную поставку.
- Работу по проектам и поставку образцов.
- Формирование склада под заказчика.
- Сертификаты соответствия на поставляемую продукцию (по желанию клиента).
- Тестирование поставляемой продукции.
- Поставку компонентов, требующих военную и космическую приемку.
- Входной контроль качества.
- Наличие сертификата ISO.

В составе нашей компании организован Конструкторский отдел, призванный помогать разработчикам, и инженерам.

Конструкторский отдел помогает осуществить:

- Регистрацию проекта у производителя компонентов.
- Техническую поддержку проекта.
- Защиту от снятия компонента с производства.
- Оценку стоимости проекта по компонентам.
- Изготовление тестовой платы монтаж и пусконаладочные работы.



Тел: +7 (812) 336 43 04 (многоканальный)

Email: org@lifeelectronics.ru