

RoHS Compliant

## Features

- High specific capacitance
- 0.01 farad to 1.0 farad
- Very low ESR down to 25 milliOhm
- Low profile: down to 2.1mm height
- High power pulse capability
- Leakage current 5-120 micro amperes
- Non-polar
- Foot prints 20×15mm or 28×17mm or 48×30mm
- Voltage ratings 3.6V-20V
- Operating temperature range: -20 to +70°C

## Applications

- GSM/ GPRS Wireless Communication Products
- ADSL/ xDSL and Other Communication Equipment
- Automatic Meter Reading Systems
- Wireless Alarm Systems
- Memory Back-up
- Mainframe Computer De-coupling
- Hybrid Battery Packs
- Portable Medical Laser
- Energy Harvest

## How to Order

BZ 01 5 A 503 Z A B □ □  
① ② ③ ④ ⑤ ⑥ ⑦ ⑧ ⑨

- ① Series (BZ: BestCap)  
② Size

01/ 11	28×17mm	02/ 12	48×30mm
5/ 15	20×15mm	09	17×15mm

- ③ Rated Voltage (VDC)

3	3.6	C	12.0
4	4.5	F	15.0
5	5.5	G	16.0
9	9.0	K	20.0

- ④ A: Standard  
B: LowProfile

- ⑤ Capacitance (μF) (three digits style)

ex:	204	200mF
603	60mF	1000mF

- ⑥ Tolerance

Z	+80%/ -20%
---	------------

- ⑦ Lead Specifications

A	Through Hole Type	L	4 terminals surface mount type
H	Stand off Type	S	3 terminals surface mount type
N	2 terminals surface mount type	W	Flex wire type

- ⑧ Package

B	Bulk in tray
---	--------------

- ⑨ Option

## Ratings and Part Number Reference

- BZ01/ BZ11 case size

AVX Part Number	Rated Voltage	Cap (mF)	ESR (mΩ@1kHz)		Leakage Current (μA max)	Height (mm max)			
			typ.	max.		A-lead	H-lead	S-lead	S-lead (AJ)*
BZ013B503Z_B	3.6	50	100	120	5	—	—	3.2	2.1
BZ013A703Z_B	3.6	70	140	168	5	3.5	6.4	4.0	2.9
BZ113B104Z_B	3.6	100	100	120	10	—	—	3.2	2.1
BZ013A144Z_B	3.6	140	70	84	5	5.3	8.2	5.8	—
BZ014B333Z_B	4.5	33	150	180	5	—	—	3.5	2.4
BZ015B303Z_B	5.5	30	160	192	5	—	—	3.8	2.7
BZ015A503Z_B	5.5	50	160	192	5	4.1	7.0	4.6	3.5
BZ015B603Z_B	5.5	60	80	96	10	5.4	8.3	5.9	—
BZ015A104Z_B	5.5	100	80	96	10	6.7	9.6	7.2	—
BZ019B223Z_B	9.0	22	250	300	5	4.7	7.6	5.2	4.1
BZ019A333Z_B	9.0	33	250	300	5	5.5	8.4	6.0	4.9
BZ01CB153Z_B	12.0	15	350	420	5	5.9	8.8	6.4	5.3
BZ01CA223Z_B	12.0	22	350	420	5	7.1	10.0	7.6	6.5

\* Select S-Lead BZ01 BestCap are available with insulation on the bottom of the part and zero clearance from the PCB. To order, please add special requirement AJ to the end of the part number. Example) BZ013B503ZSBAJ

- BZ02/ BZ12 case size

AVX Part Number	Rated Voltage	Cap (mF)	ESR (mΩ@1kHz)		Leakage Current (μA max)	Height (mm max)		
			typ.	max.		A-lead	H-lead	L-lead
BZ023A284Z_B	3.6	280	45	54	20	3.5	6.4	3.7
BZ023A564Z_B	3.6	560	25	30	40	5.3	8.2	5.5
BZ025A204Z_B	5.5	200	60	72	20	4.1	7.0	4.3
BZ025A404Z_B	5.5	400	35	42	40	6.7	9.6	6.9
BZ125A105Z_B	5.5	1000	35	42	120	6.7	9.6	6.9
BZ029A124Z_B	9.0	120	70	84	20	5.8	8.7	6.0
BZ02CA903Z_B	12.0	90	90	108	20	7.4	10.3	7.6
BZ12GA124Z_B	16.0	120	160	192	60	9.1	—	9.1

- BZ05/ BZ15 case size

AVX Part Number	Rated Voltage	Cap (mF)	ESR (mΩ@1kHz)		Leakage Current (μA max)	Height (mm max)	
			typ.	max.		N-lead	S-lead
BZ054B223Z_B	4.5	22	170	204	5	2.3	2.3
BZ154B473Z_B	4.5	47	170	204	10	2.3	2.3
BZ055B153Z_B	5.5	15	250	300	5	2.7	2.7
BZ055A333Z_B	5.5	33	250	300	5	3.5	3.5
BZ055B333Z_B	5.5	33	125	150	10	—	4.8
BZ055A683Z_B	5.5	68	125	150	10	—	6.1
BZ155A104Z_B	5.5	100	125	150	20	—	6.1
BZ05CA103Z_B	12.0	10	500	600	5	6.5	6.5
BZ05FB682Z_B	15.0	6.8	500	600	10	5.8	5.8
BZ05KB472Z_B	20.0	4.7	700	840	10	—	6.7

- BZ09 case size

AVX Part Number	Rated Voltage	Cap (mF)	ESR (mΩ@1kHz)		Leakage Current (μA max)	Height (mm max)	
			typ.	max.		N-lead	S-lead
BZ094B153Z_BA1	4.5	15	250	300	5	2.4	2.3

**Typical Characteristics Over Temperature Range:**

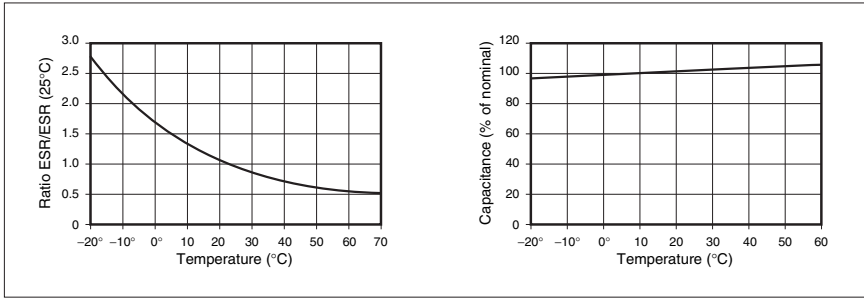

**Impedance and ESR Versus Frequency**

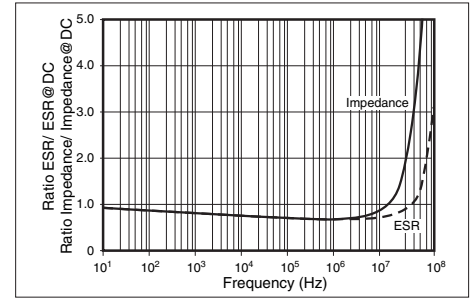

**Lead Types**

- A Lead (Through Hole type)

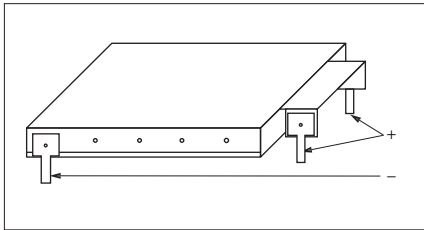

- L Lead (4 terminals surface mount type)

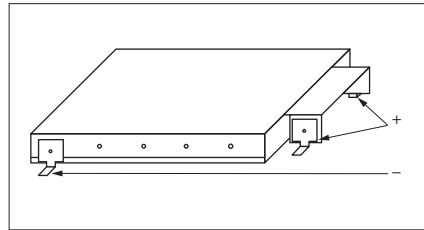

- S Lead (3 terminals surface mount type)

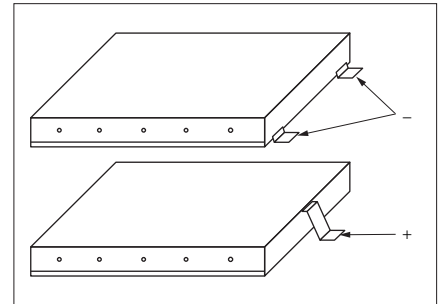

- H Lead (Stand off type)

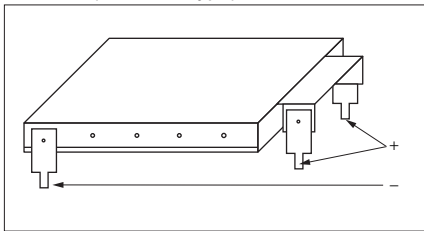

- N Lead (2 terminals surface mount type)

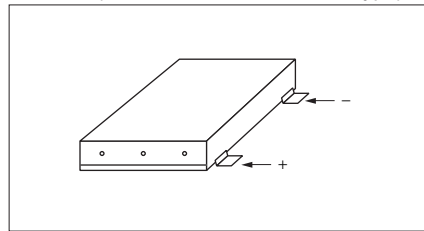

**Recommended Footprint Dimensions**

- A Lead

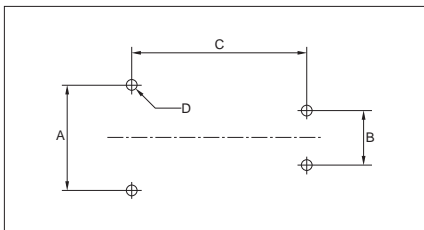

Pad dimensions: mm

Case	A ±0.05	B ±0.05	C ±0.05	D ±0.1
BZ01	17.25	8.9	28	φ1.4
BZ02/ BZ12	30.25	8.9	48	φ1.4

- L Lead

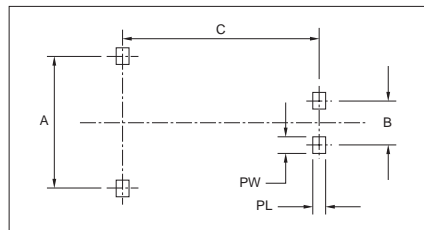

Pad dimensions: mm

Case	A ±0.1	B ±0.1	C ±0.1	PL ±0.2	PW ±0.2
BZ02	32.2	10.8	48	3.2	3.7

- S Lead (3 terminals surface mount type)

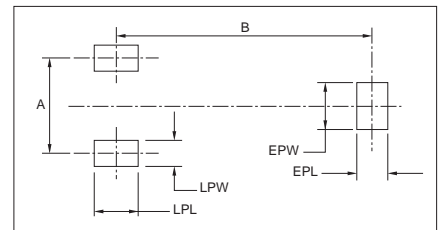

Pad dimensions: mm

Case	A ±0.1	B ±0.1	EPL ±0.1	EPW ±0.1	LPL ±0.1	LPW ±0.1
BZ01	13.0	35.1	4.5	6.0	5.8	3.5
BZ05	10.0	25.0	3.0	4.5	2.9	4.5
BZ09	10.0	22.0	3.0	4.5	2.9	4.5

- H Lead (Stand off type)

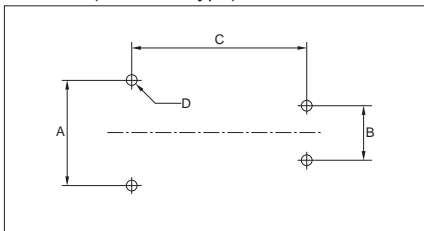

Pad dimensions: mm

Case	A ±0.05	B ±0.05	C ±0.05	D ±0.1
BZ01	17.25	8.9	28	φ1.4
BZ02/ BZ12	30.25	8.9	48	φ1.4

- N Lead (2 terminals surface mount type)

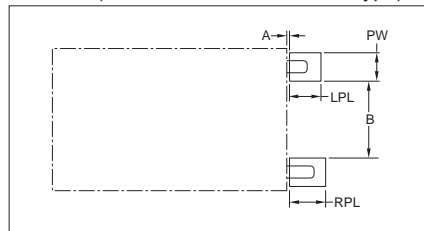

Pad dimensions: mm

Case	A ±0.5	B ±0.1	PW ±0.1	LPL ±0.1	RPL ±0.1
BZ05	1.0	5.9	4.1	2.5	3.5
BZ09	1.0	5.9	4.1	2.5	3.5

Компания «Life Electronics» занимается поставками электронных компонентов импортного и отечественного производства от производителей и со складов крупных дистрибьюторов Европы, Америки и Азии.

С конца 2013 года компания активно расширяет линейку поставок компонентов по направлению коаксиальный кабель, кварцевые генераторы и конденсаторы (керамические, пленочные, электролитические), за счёт заключения дистрибьюторских договоров

Мы предлагаем:

- Конкурентоспособные цены и скидки постоянным клиентам.
- Специальные условия для постоянных клиентов.
- Подбор аналогов.
- Поставку компонентов в любых объемах, удовлетворяющих вашим потребностям.
- Приемлемые сроки поставки, возможна ускоренная поставка.
- Доставку товара в любую точку России и стран СНГ.
- Комплексную поставку.
- Работу по проектам и поставку образцов.
- Формирование склада под заказчика.
- Сертификаты соответствия на поставляемую продукцию (по желанию клиента).
- Тестирование поставляемой продукции.
- Поставку компонентов, требующих военную и космическую приемку.
- Входной контроль качества.
- Наличие сертификата ISO.

В составе нашей компании организован Конструкторский отдел, призванный помогать разработчикам, и инженерам.

Конструкторский отдел помогает осуществить:

- Регистрацию проекта у производителя компонентов.
- Техническую поддержку проекта.
- Защиту от снятия компонента с производства.
- Оценку стоимости проекта по компонентам.
- Изготовление тестовой платы монтаж и пусконаладочные работы.



Тел: +7 (812) 336 43 04 (многоканальный)

Email: [org@lifeelectronics.ru](mailto:org@lifeelectronics.ru)