

3-INPUT / 2-INPUT VIDEO SWITCH

■ GENERAL DESCRIPTION

The **NJM2508** is video switch for video and audio signal. It contains 3 input-1 output and 2 input-1 output video switch. One input terminal has clamp function and so is applied to fixed DC level of video signal. Its operating voltage is 4.75 to 13V and bandwidth is 10MHz. Crosstalk is 75dB (at $f = 4.43\text{MHz}$)

■ PACKAGE OUTLINE



NJM2508D

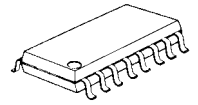

NJM2508M

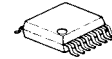

NJM2508V

■ FEATURES

- Operating Voltage (+4.75V to +13V)
- 3 Input-1 Output and 2 Input-1 Output
- Crosstalk 75dB (at 4.43MHz)
- Wide Frequency Range 10MHz (2V_{P-P} Input)
- Package Outline DIP16, DMP16, SSOP16
- Bipolar Technology

■ RECOMMENDED OPERATING CONDITION

- Operating Voltage V^+ 4.75V to 13.0V

■ APPLICATION

- VCR, Video Camera, AV-TV, Video Disk Player.

■ BLOCK DIAGRAM

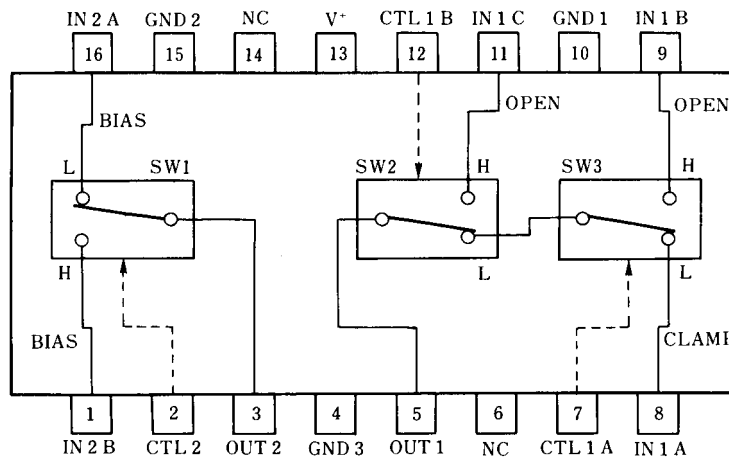

NJM2508D
NJM2508M
NJM2508V

NJM2508

■ ABSOLUTE MAXIMUM RATINGS

($T_a = 25^\circ\text{C}$)

| PARAMETER | SYMBOL | RATINGS | UNIT |
|-----------------------------|-----------|--|------------------|
| Supply Voltage | V^+ | 14 | V |
| Power Dissipation | P_D | (DIP16) 700 (DMP16) 350 (SSOP16) 300 | mW mW mW |
| Operating Temperature Range | T_{opr} | -40 to +85 | $^\circ\text{C}$ |
| Storage Temperature Range | T_{stg} | -40 to +125 | $^\circ\text{C}$ |

■ ELECTRICAL CHARACTERISTICS

($V^+ = 5\text{V}$, $T_a = 25^\circ\text{C}$)

| PARAMETER | SYMBOL | TEST CONDITION | MIN. | TYP. | MAX. | UNIT |
|-----------------------|-----------|---|------|------|------|------|
| Operating Current 1 | I_{CC1} | $V^+ = 5\text{V}$ (Note1) | 6.6 | 9.4 | 12.3 | mA |
| Operating Current 2 | I_{CC2} | $V^+ = 9\text{V}$ (Note1) | 8.0 | 11.5 | 15.0 | mA |
| Voltage Gain | G_V | $V_I = 2V_{P.P.} / 100\text{kHz}$, V_O / V_I | -0.6 | -0.1 | +0.4 | dB |
| Frequency Response | G_f | $V_I = 2V_{P.P.}$, V_O (10MHz / 100kHz) | -1.0 | 0 | +1.0 | dB |
| Differential Gain | DG | $V_I = 2V_{P.P.}$, Staircase Signal | - | 0.3 | - | % |
| Differential Phase | DP | $V_I = 2V_{P.P.}$, Staircase Signal | - | 0.3 | - | deg |
| Output offset Voltage | V_{OS} | (Note2) | -10 | 0 | +10 | mV |
| Crosstalk | CT | $V_I = 2V_{P.P.}$, 4.43MHz, V_O / V_I | - | -75 | - | dB |
| Switch Change Voltage | V_{CH} | All inside SW : ON | 2.5 | - | - | V |
| Switch Change Voltage | V_{CL} | All inside SW : OFF | - | - | 1.0 | V |

(Note1) $S1 = S2 = S3 = S4 = S5 = S6 = S7 = 1$

(Note2) Output DC Voltage Difference is tested on $S6 = 1 \rightarrow 2$, $S1 = S2 = S3 = S4 = S5 = 1$, $S8 = 2$ and $S7 = 1$

■ TEST CIRCUIT

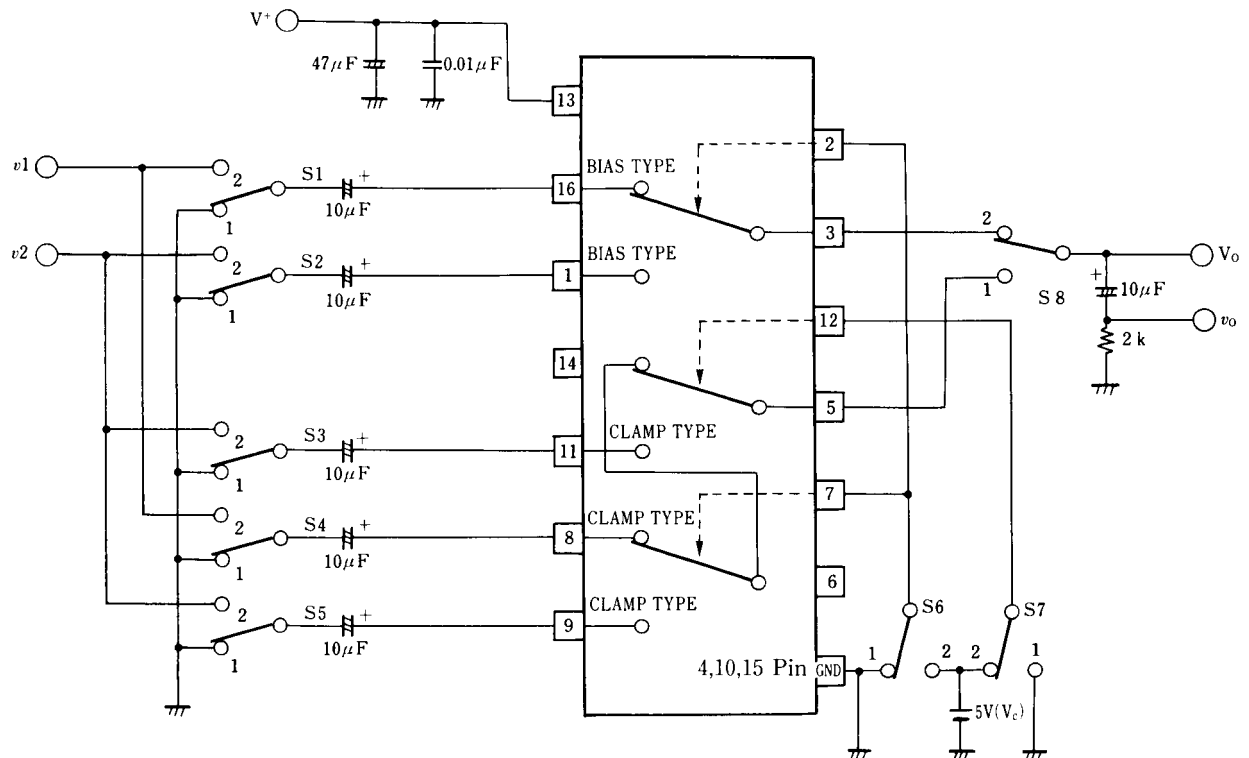

■ PIN FUNCTION

| PIN No. | PIN NAME | DC VOLTAGE | INSIDE EQUIVALENT CIRCUIT |
|---------------|--|------------|---------------------------|
| 16 1 | IN 2 A IN 2 B [Input] | 2.5V | |
| 8 | IN 1 A [Input] | 1.5V | |
| 9 11 | IN 1 B IN 1 C [Input] | | |
| 7 12 2 | CTL 1 A CTL 1 B CTL 2 [Control] | | |
| 5 | OUT1 [Output] | 1.8V | |
| 3 | OUT2 [Output] | 0.8V | |
| 13 | V ⁺ | 5V | |
| 15 4 10 | GND 1 GND 2 GND 3 | | |

■ TYPICAL CHARACTERISTICS (Ta = +25°C)

Operating Current vs. Operating Voltage

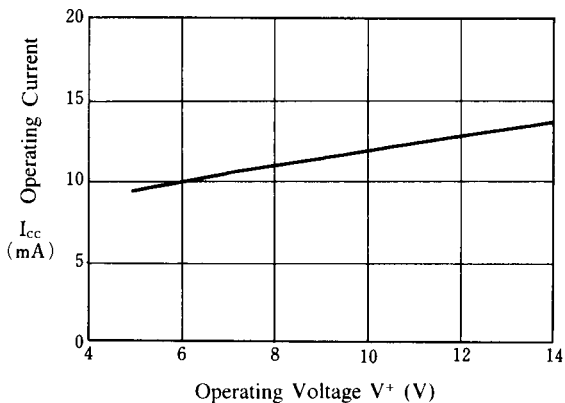

Operating Current vs. Ambient Temperature (V⁺ = 5 V)

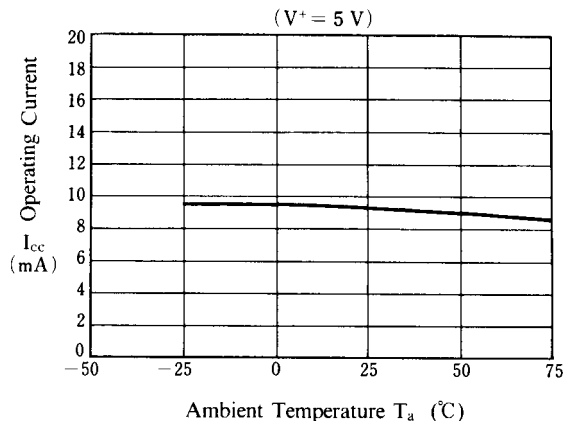

Operating Current vs. Ambient Temperature (V⁺ = 9 V)

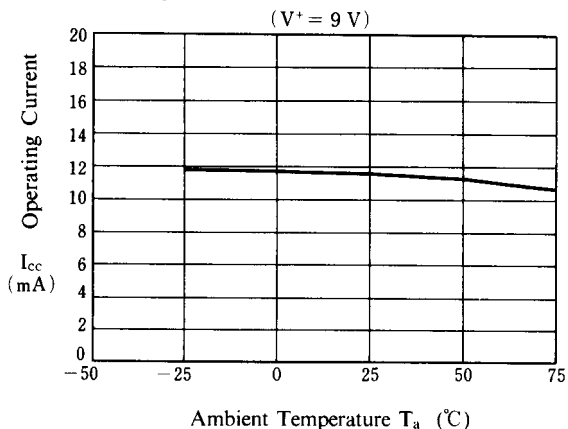

Voltage Gain vs. Operating Voltage (Ta = 25°C)

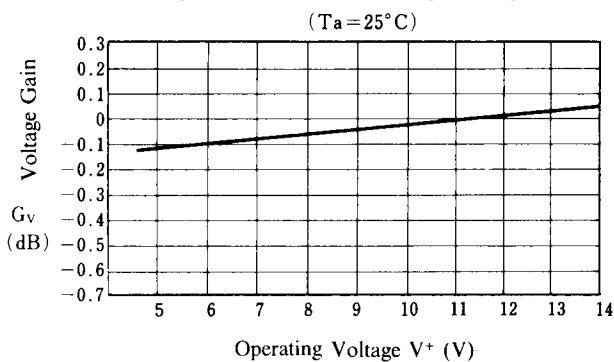

Voltage Gain vs. Frequency (Ta = 25°C, V⁺ = 5V)

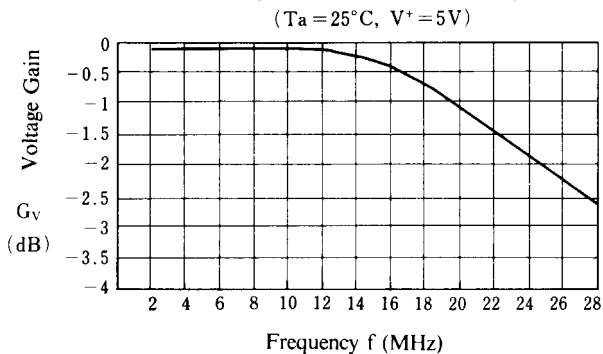

Voltage Gain vs. Ambient Temperature (V⁺ = 5V)

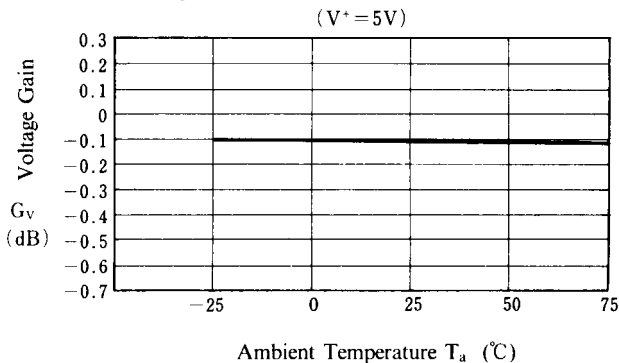

■ TYPICAL CHARACTERISTICS (Ta = +25°C)

Frequency Response vs. Operating Voltage

(Ta = 25°C)

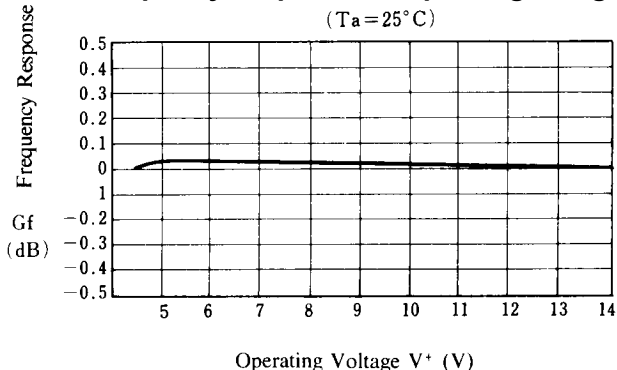

Frequency Response vs. Ambient Temperature

(V⁺ = 5V)

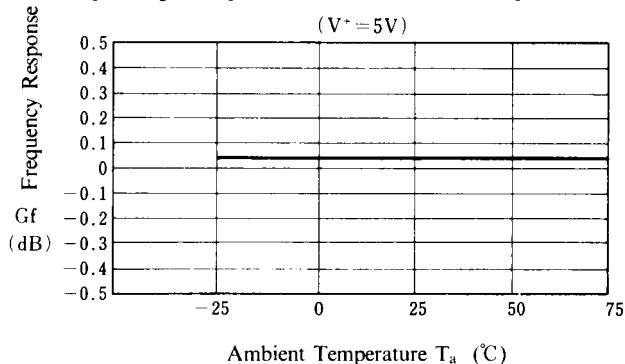

Offset Voltage vs. Operating Voltage

(Ta = 25°C)

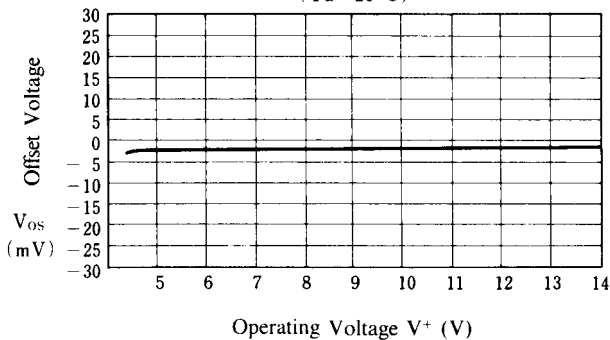

Offset Voltage vs. Ambient Temperature

(V⁺ = 5V)

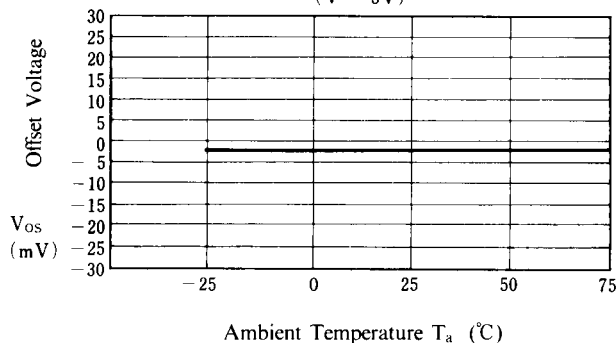

Switch Change Voltage vs. Operating Voltage

(Ta = 25°C)

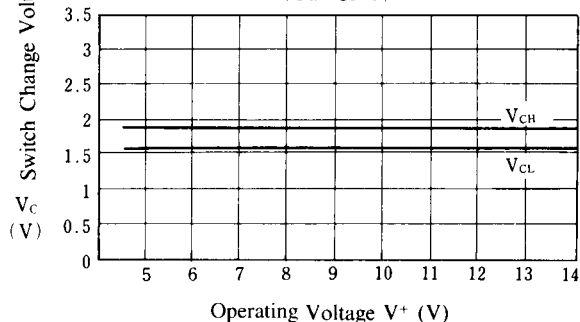

Switch Change Voltage vs. Ambient Temperature

(V⁺ = 5V)

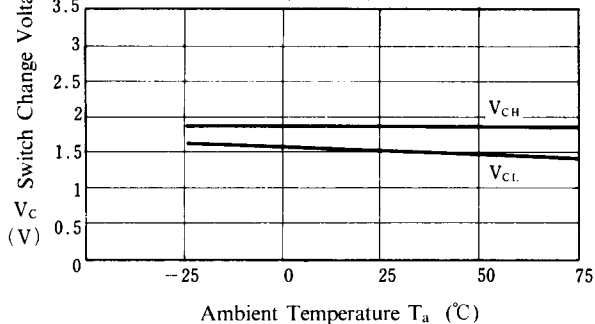

■ TYPICAL CHARACTERISTICS (Ta = +25°C)

Differential Gain vs. Operating Voltage

(Ta = 25°C)

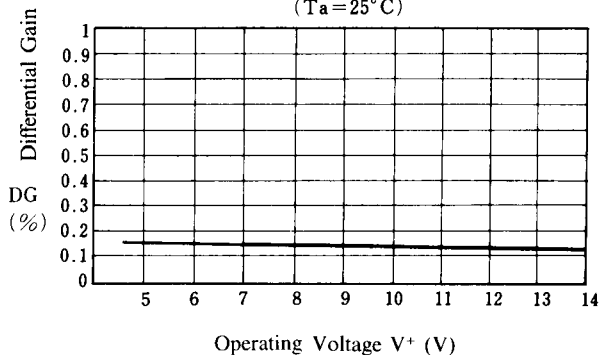

Differential Phase vs. Operating Voltage

(Ta = 25°C)

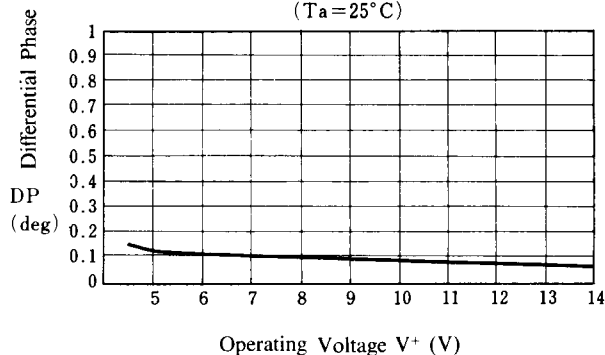

Differential Gain vs. Ambient Temperature

(V+ = 5V)

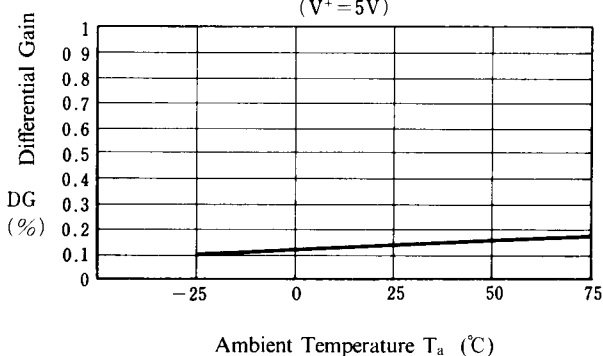

Differential Phase vs. Ambient Temperature

(V+ = 5V)

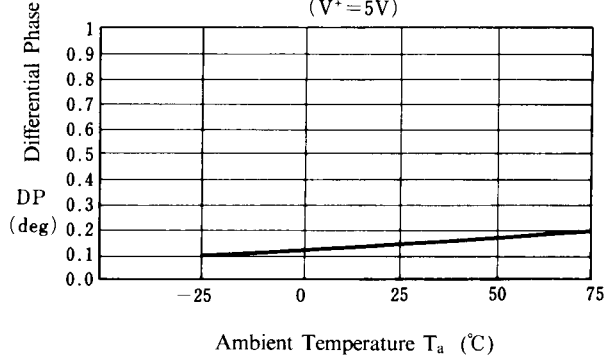

Differential Gain vs. Load

(Ta = 25°C, V+ = 5V)

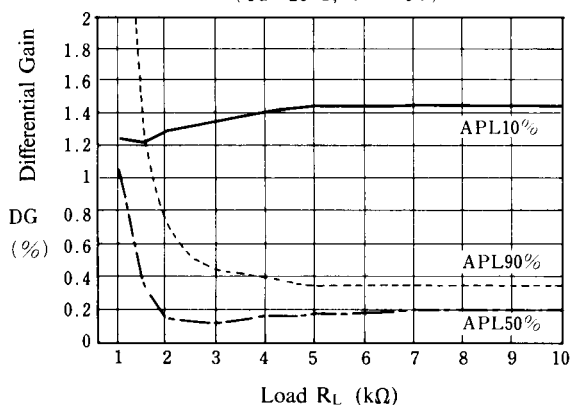

Differential Phase vs. Load

(Ta = 25°C, V+ = 5V)

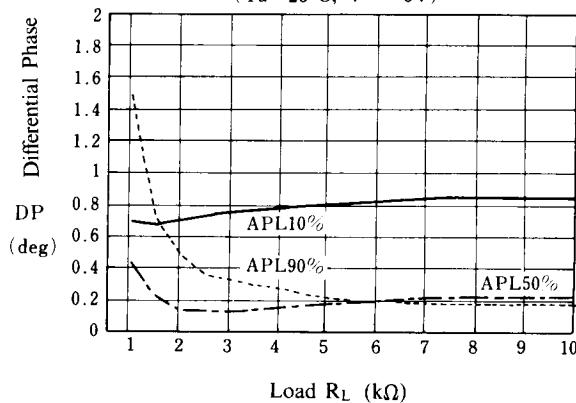

■ TYPICAL CHARACTERISTICS (Ta = +25°C)

Differential Gain vs. APL

(Ta = 25°C, V+ = 5V)

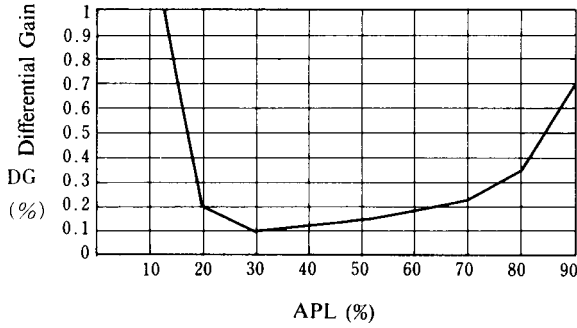

Differential Phase vs. APL

(Ta = 25°C, V+ = 5V)

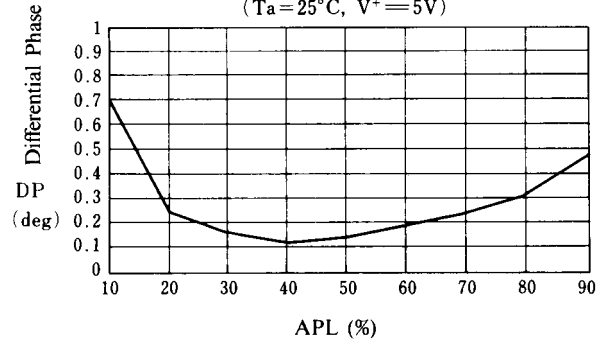

Differential Gain vs. Load

(Ta = 25°C, V+ = 5V)

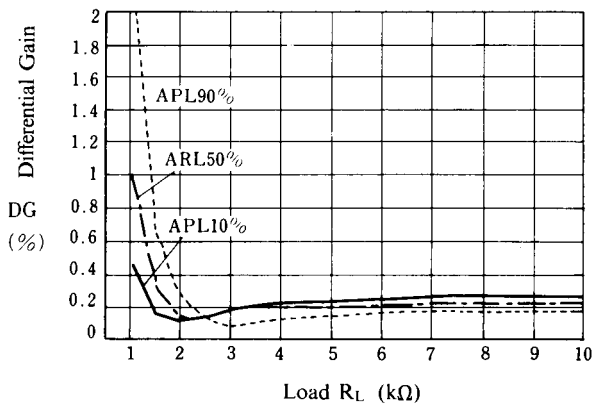

Differential Phase vs. Load

(Ta = 25°C, V+ = 5V)

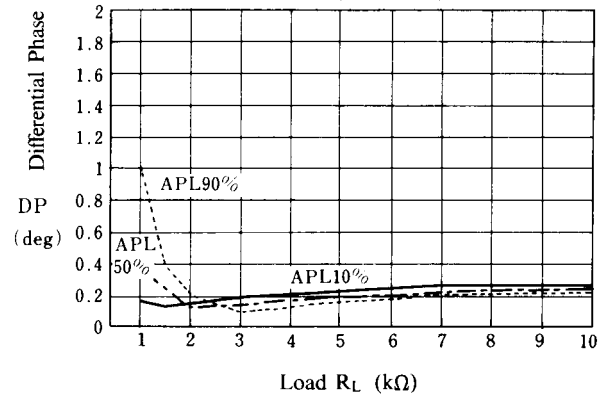

Differential Gain vs. APL

(Ta = 25°C, V+ = 5V)

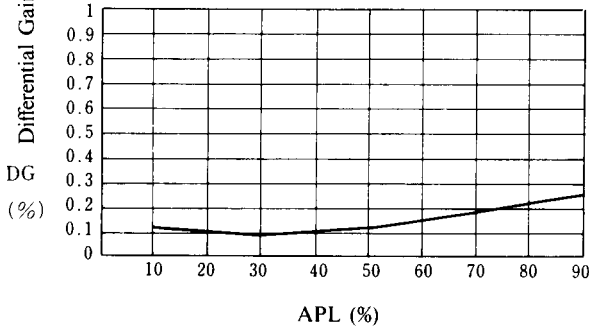

Differential Phase vs. APL

(Ta = 25°C, V+ = 5V)

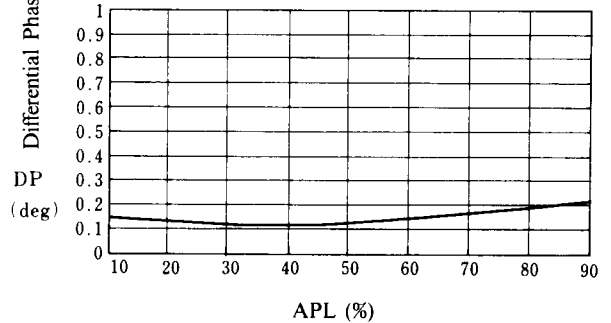

■ TYPICAL CHARACTERISTICS (Ta = +25°C)

Crosstalk vs. Operating Voltage

(Ta = 25°C)

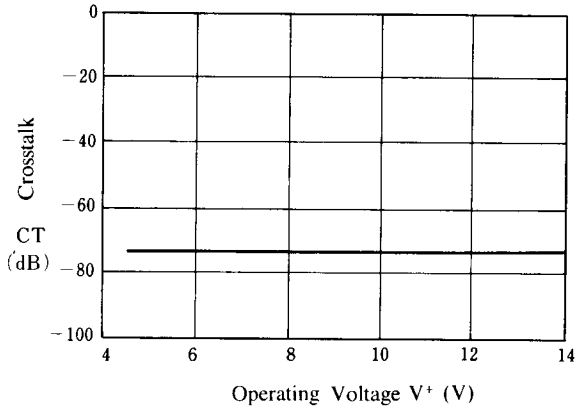

Crosstalk vs. Temperature

(V+ = 5V)

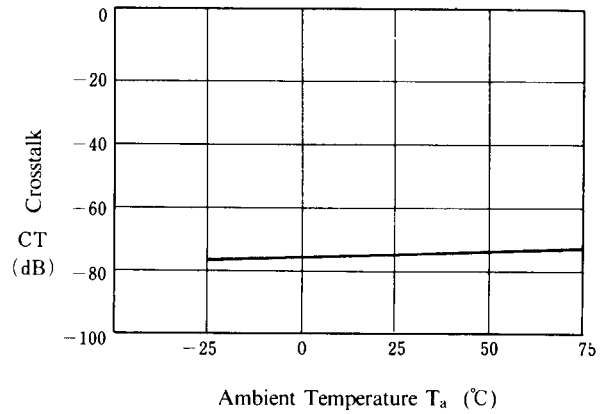

Crosstalk vs. Operating Voltage

(Ta = 25°C)

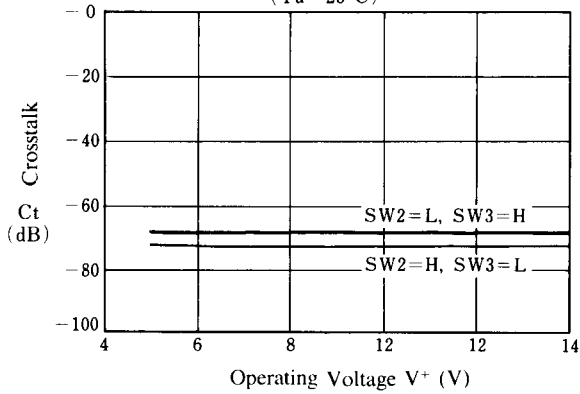

Crosstalk vs. Ambient Temperature

(V+ = 5V)

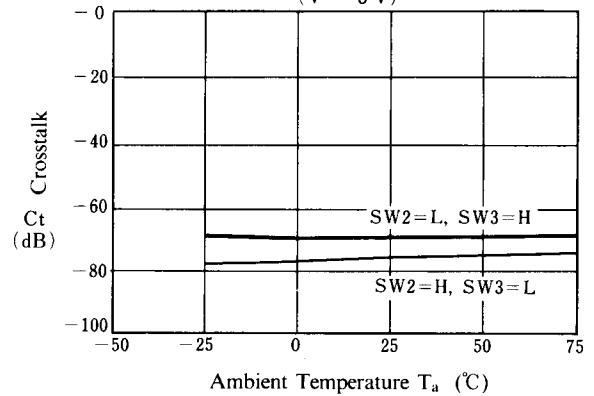

Crosstalk vs. Operating Voltage

(Ta = 25°C)

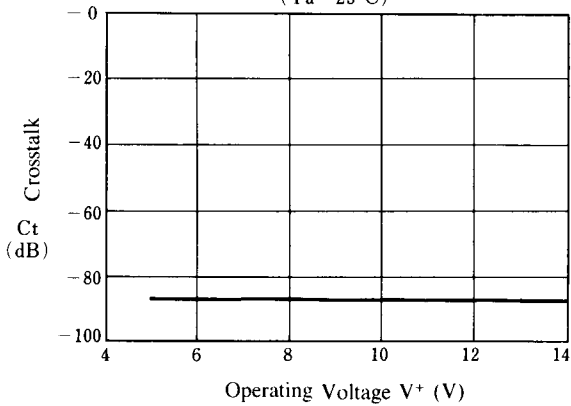

Crosstalk vs. Ambient Temperature

(V+ = 5V)

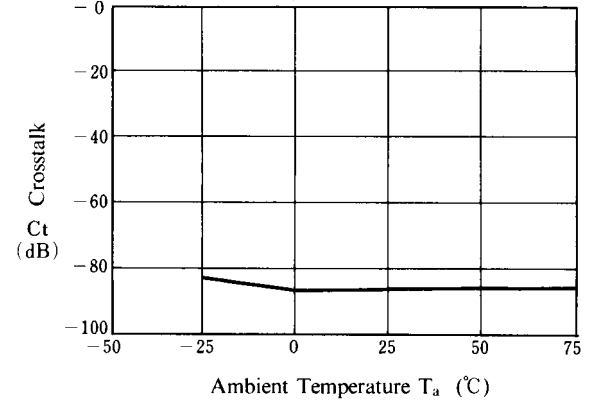

■ TYPICAL CHARACTERISTICS (T_a = +25°C)

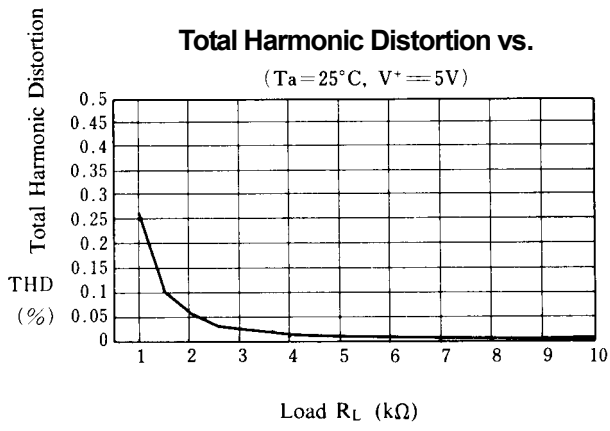

NJM2508

■ APPLICATION

This IC requires $1\text{M}\Omega$ resistance between INPUT and GND pin for clamp type input since the minute current causes an unstable pin voltage.

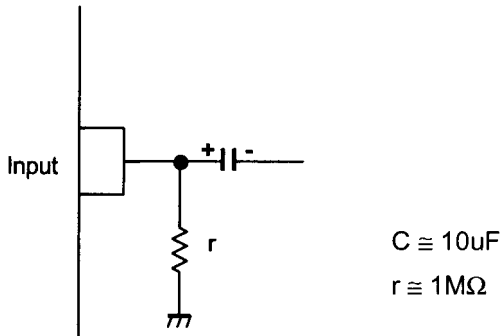

This IC requires $0.1\mu\text{F}$ capacitor between INPUT and GND, $1\text{M}\Omega$ resistance between INPUT and GND for clamp type input at mute mode.

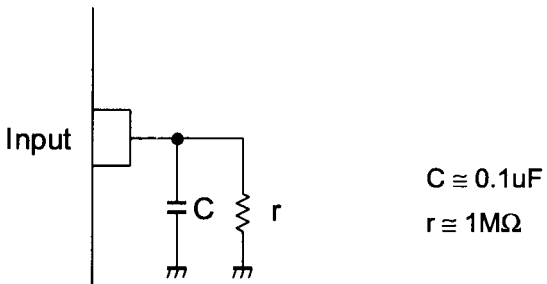

This IC requires $0.1\mu\text{F}$ capacitor between INPUT and GND for bias type input at mute mode.

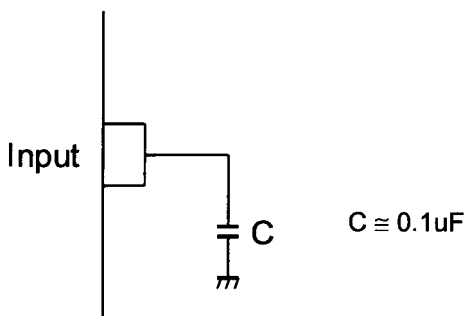

[CAUTION]
The specifications on this databook are only given for information, without any guarantee as regards either mistakes or omissions. The application circuits in this databook are described only to show representative usages of the product and not intended for the guarantee or permission of any right including the industrial rights.

Компания «Life Electronics» занимается поставками электронных компонентов импортного и отечественного производства от производителей и со складов крупных дистрибьюторов Европы, Америки и Азии.

С конца 2013 года компания активно расширяет линейку поставок компонентов по направлению коаксиальный кабель, кварцевые генераторы и конденсаторы (керамические, пленочные, электролитические), за счёт заключения дистрибьюторских договоров

Мы предлагаем:

- Конкурентоспособные цены и скидки постоянным клиентам.
- Специальные условия для постоянных клиентов.
- Подбор аналогов.
- Поставку компонентов в любых объемах, удовлетворяющих вашим потребностям.
- Приемлемые сроки поставки, возможна ускоренная поставка.
- Доставку товара в любую точку России и стран СНГ.
- Комплексную поставку.
- Работу по проектам и поставку образцов.
- Формирование склада под заказчика.
- Сертификаты соответствия на поставляемую продукцию (по желанию клиента).
- Тестирование поставляемой продукции.
- Поставку компонентов, требующих военную и космическую приемку.
- Входной контроль качества.
- Наличие сертификата ISO.

В составе нашей компании организован Конструкторский отдел, призванный помогать разработчикам, и инженерам.

Конструкторский отдел помогает осуществить:

- Регистрацию проекта у производителя компонентов.
- Техническую поддержку проекта.
- Защиту от снятия компонента с производства.
- Оценку стоимости проекта по компонентам.
- Изготовление тестовой платы монтаж и пусконаладочные работы.



Тел: +7 (812) 336 43 04 (многоканальный)

Email: org@lifeelectronics.ru