

FEATURES

- Small signal bandwidth: 260 MHz
- Ultralow power 1.25mA
- Extremely low harmonic distortion
 - 122 dB THD at 50 kHz
 - 96 dB THD at 1 MHz
- Low input voltage noise: 3.9 nV/√Hz
- 0.35 mV maximum offset voltage
- Balanced outputs
- Settling time to 0.1%: 34 ns
- Rail-to-rail output: $-V_S + 0.1\text{ V}$ to $+V_S - 0.1\text{ V}$
- Adjustable output common-mode voltage
- Flexible power supplies: 3 V to 7 V (LFCSP)
- Disable pin to reduce power consumption
- ADA4940-1 is available in LFCSP and SOIC packages

APPLICATIONS

- Low power PuSAR®/SAR ADC drivers
- Single-ended-to-differential conversion
- Differential buffers
- Line drivers
- Medical imaging
- Industrial process controls
- Portable electronics

GENERAL DESCRIPTION

The ADA4940-1/ADA4940-2 are low noise, low distortion fully differential amplifiers with very low power consumption. They are an ideal choice for driving low power, high resolution, high performance SAR and sigma-delta ($\Sigma\text{-}\Delta$) analog-to-digital converters (ADCs) with resolutions up to 16 bits from dc to 1 MHz on only 1.25 mA of quiescent current. The adjustable level of the output common-mode voltage allows the ADA4940-1/ADA4940-2 to match the input common-mode voltage of multiple ADCs. The internal common-mode feedback loop provides exceptional output balance, as well as suppression of even-order harmonic distortion products.

With the ADA4940-1/ADA4940-2, differential gain configurations are easily realized with a simple external feedback network of four resistors determining the closed-loop gain of the amplifier. The ADA4940-1/ADA4940-2 are fabricated using Analog Devices, Inc., SiGe complementary bipolar process, enabling them to achieve very low levels of distortion with an input voltage noise of only 3.9 nV/√Hz. The low dc offset and excellent dynamic performance of the ADA4940-1/ADA4940-2 make them well suited for a variety of data acquisition and signal processing applications.

Rev. B

Information furnished by Analog Devices is believed to be accurate and reliable. However, no responsibility is assumed by Analog Devices for its use, nor for any infringements of patents or other rights of third parties that may result from its use. Specifications subject to change without notice. No license is granted by implication or otherwise under any patent or patent rights of Analog Devices. Trademarks and registered trademarks are the property of their respective owners.

FUNCTIONAL BLOCK DIAGRAMS

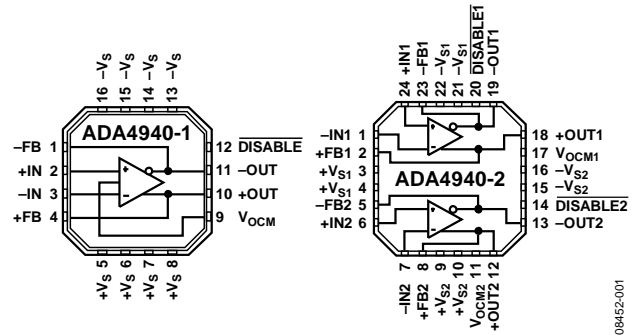

Figure 1.

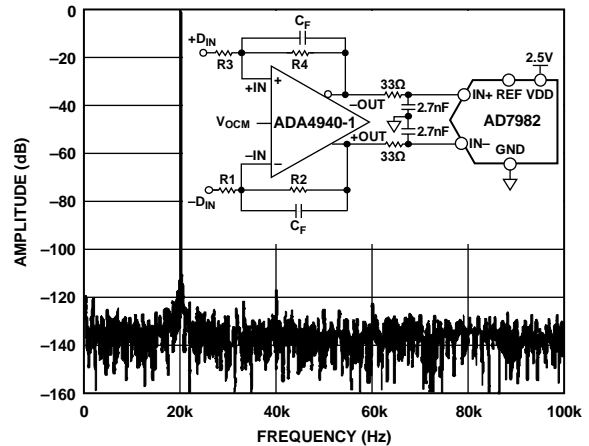

Figure 2. ADA4940-1 Driving the AD7982 ADC

The ADA4940-1 is available in a Pb-free, 3 mm × 3 mm, 16-lead LFCSP, and an 8-lead SOIC. The ADA4940-2 is available in a Pb-free, 4 mm × 4 mm, 24-lead LFCSP. The pinout is optimized to facilitate printed circuit board (PCB) layout and minimize distortion. The ADA4940-1/ADA4940-2 are specified to operate over the -40°C to $+125^{\circ}\text{C}$ temperature range.

Table 1. Similar Products to the ADA4940-1/ADA4940-2

Product	I _{supply} (mA)	Bandwidth (MHz)	Slew Rate (V/μs)	Noise (nV/√Hz)
AD8137	3	110	450	8.25
ADA4932-x	9	560	2800	3.6
ADA4941-1	2.2	31	22	5.1

Table 2. Complementary Products to the ADA4940-1/ADA4940-2

Product	Power (mW)	Throughput (MSPS)	Resolution (Bits)	SNR (dB)
AD7982	7.0	1	18	98
AD7984	10.5	1.333	18	96.5
AD7621	65	3	16	88
AD7623	45	1.333	16	88

TABLE OF CONTENTS

Features 1

Applications..... 1

General Description 1

Functional Block Diagrams..... 1

Revision History 2

Specifications..... 3

$V_S = 5\text{ V}$ 3

$V_S = 3\text{ V}$ 5

Absolute Maximum Ratings..... 7

 Thermal Resistance 7

 Maximum Power Dissipation 7

 ESD Caution..... 7

Pin Configurations and Function Descriptions 8

Typical Performance Characteristics 10

Test Circuits..... 19

Terminology 20

 Definition of Terms..... 20

Theory of Operation 21

Applications Information 22

 Analyzing an Application Circuit 22

 Setting the Closed-Loop Gain 22

 Estimating the Output Noise Voltage 22

 Impact of Mismatches in the Feedback Networks 23

 Calculating the Input Impedance of an Application Circuit 23

 Input Common-Mode Voltage Range 24

 Input and Output Capacitive AC Coupling..... 25

 Setting the Output Common-Mode Voltage 25

 DISABLE Pin 25

 Driving a Capacitive Load..... 25

 Driving a High Precision ADC 26

Layout, Grounding, and Bypassing..... 27

 ADA4940-1 LFCSP Example 27

Outline Dimensions 28

 Ordering Guide 29

REVISION HISTORY

3/12—Rev. A to Rev. B

Reorganized Layout..... Universal

Added ADA4940-1 8-Lead SOIC Package..... Universal

Changes to Features Section, Table 1, and Figure 1; Replaced Figure 2 1

Changed $V_S = \pm 2\text{ V}$ (or $+5\text{ V}$) Section to $V_S = +5\text{ V}$ Section..... 3

Changes to $V_S = +5\text{ V}$ Section and Table 3..... 3

Changes to Table 4 and Table 5..... 4

Changes to $V_S = 3\text{ V}$ Section and Table 6 5

Changes to Table 7 and Table 8..... 6

Added Figure 5 and Table 12, Renumbered Sequentially 9

Changes to Figure 7, Figure 8, and Figure 9..... 10

Added Figure 15 and Figure 18; Changes to Figure 13, Figure 14, and Figure 16 11

Changes to Figure 19 and Figure 20..... 12

Changes to Figure 25, Figure 26, and Figure 27; Added Figure 28, Figure 29, and Figure 30..... 13

Changes to Figure 31, Figure 32, Figure 33, Figure 34, Figure 35, and Figure 36..... 14

Changes to Figure 37, Figure 38, Figure 39, and Figure 41..... 15

Changes to Figure 49, Figure 50, and Figure 51 17

Added Figure 55 and Figure 57..... 18

Changes to Differential V_{OS} , Differential CMRR, and V_{OCM} CMRR Section 20

Changes to Calculating the Input Impedance of an Application

Circuit Section 23

Changes to Figure 71..... 25

Changes to Driving a High Precision ADC Section and Figure 73..... 26

Changed ADA4940-1 Example Section to ADA4940-1 LFCSP Example Section 27

Changes to Ordering Guide 29

12/11—Rev. 0 to Rev. A

Changes to Features Section, General Description Section, Table 1 1

Replaced Figure 1 and Figure 2 1

Changes to $V_S = \pm 2.5\text{ V}$ (or $+5\text{ V}$) Section and Table 3..... 3

Changes to Table 6..... 5

Replaced Figure 7, Figure 8, Figure 9, and Figure 10 9

Replaced Figure 14, Figure 15, and Figure 17..... 10

Replaced Figure 24 and Figure 27 12

Changes to Figure 37..... 14

Replaced Figure 43 and Figure 46..... 15

Replaced Figure 53 18

Changes to Estimating the Output Noise Voltage Section, Table 14, Table 15, and Calculating the Input Impedance of an Application Circuit Section..... 21

Changes to Input Common-Mode Voltage Range Section..... 22

Changes to Driving a High Precision ADC Section and Figure 65 24

10/11—Revision 0: Initial Version

SPECIFICATIONS

$V_S = 5\text{ V}$

$V_{OCM} = \text{Mid Supply}$, $R_F = R_G = 1\text{ k}\Omega$, $R_{L, dm} = 1\text{ k}\Omega$, $T_A = 25^\circ\text{C}$, LFCSP package, unless otherwise noted. T_{MIN} to $T_{MAX} = -40^\circ\text{C}$ to $+125^\circ\text{C}$. (See Figure 61 for the definition of terms.)

+ D_{IN} or - D_{IN} to $V_{OUT, dm}$ Performance

Table 3.

Parameter	Test Conditions/Comments	Min	Typ	Max	Unit
DYNAMIC PERFORMANCE					
-3 dB Small Signal Bandwidth	$V_{OUT, dm} = 0.1\text{ V p-p}$, $G = 1$		260		MHz
	$V_{OUT, dm} = 0.1\text{ V p-p}$, $G = 2$		220		MHz
	$V_{OUT, dm} = 0.1\text{ V p-p}$, $G = 5$		75		MHz
-3 dB Large Signal Bandwidth	$V_{OUT, dm} = 2\text{ V p-p}$, $G = 1$		25		MHz
	$V_{OUT, dm} = 2\text{ V p-p}$, $G = 2$		22		MHz
	$V_{OUT, dm} = 2\text{ V p-p}$, $G = 5$		19		MHz
Bandwidth for 0.1 dB Flatness	$V_{OUT, dm} = 2\text{ V p-p}$, $G = 1$ and $G = 2$		14.5		MHz
Slew Rate	$V_{OUT, dm} = 2\text{ V step}$		95		V/ μs
Settling Time to 0.1%	$V_{OUT, dm} = 2\text{ V step}$		34		ns
Overdrive Recovery Time	$G = 2$, $V_{IN, dm} = 6\text{ V p-p}$, triangle wave		86		ns
NOISE/HARMONIC PERFORMANCE					
HD2/HD3	$V_{OUT, dm} = 2\text{ V p-p}$, $f_c = 10\text{ kHz}$		-125/-118		dBc
	$V_{OUT, dm} = 2\text{ V p-p}$, $f_c = 50\text{ kHz}$		-123/-126		dBc
	$V_{OUT, dm} = 2\text{ V p-p}$, $f_c = 50\text{ kHz}$, $G = 2$		-124/-117		dBc
	$V_{OUT, dm} = 2\text{ V p-p}$, $f_c = 1\text{ MHz}$		-102/-96		dBc
	$V_{OUT, dm} = 2\text{ V p-p}$, $f_c = 1\text{ MHz}$, $G = 2$		-100/-92		dBc
	$V_{OUT, dm} = 2\text{ V p-p}$, $f_1 = 1.9\text{ MHz}$, $f_2 = 2.1\text{ MHz}$		-99		dBc
IMD3	$V_{OUT, dm} = 2\text{ V p-p}$, $f_1 = 1.9\text{ MHz}$, $f_2 = 2.1\text{ MHz}$		-99		dBc
Input Voltage Noise	$f = 100\text{ kHz}$		3.9		nV/ $\sqrt{\text{Hz}}$
Input Current Noise	$f = 100\text{ kHz}$		0.81		pA/ $\sqrt{\text{Hz}}$
Crosstalk	$V_{OUT, dm} = 2\text{ V p-p}$, $f_c = 1\text{ MHz}$		-110		dB
INPUT CHARACTERISTICS					
Input Offset Voltage	$V_{IP} = V_{IN} = V_{OCM} = 0\text{ V}$	-0.35	± 0.06	+0.35	mV
Input Offset Voltage Drift	T_{MIN} to T_{MAX}		1.2		$\mu\text{V}/^\circ\text{C}$
Input Bias Current		-1.6	-1.1		μA
Input Bias Current Drift	T_{MIN} to T_{MAX}		-4.5		nA/ $^\circ\text{C}$
Input Offset Current		-500	± 50	+500	nA
Input Common-Mode Voltage Range			$-V_S - 0.2$ to $+V_S - 1.2$		V
Input Resistance	Differential		33		k Ω
	Common mode		50		M Ω
Input Capacitance			1		pF
Common-Mode Rejection Ratio (CMRR)	$\Delta V_{OS, dm}/\Delta V_{IN, cm}$, $\Delta V_{IN, cm} = \pm 1\text{ V dc}$	86	119		dB
Open-Loop Gain		91	99		dB
OUTPUT CHARACTERISTICS					
Output Voltage Swing	Each single-ended output	$-V_S + 0.1$ to $+V_S - 0.1$	$-V_S + 0.07$ to $+V_S - 0.07$		V
Linear Output Current	$f = 1\text{ MHz}$, $R_{L, dm} = 22\text{ }\Omega$, SFDR = -60 dBc		46		mA peak
Output Balance Error	$f = 1\text{ MHz}$, $\Delta V_{OUT, cm}/\Delta V_{OUT, dm}$		-65	-60	dB

V_{OCM} to V_{OUT,cm} Performance

Table 4.

Parameter	Test Conditions/Comments	Min	Typ	Max	Unit
V_{OCM} DYNAMIC PERFORMANCE					
-3 dB Small Signal Bandwidth	V _{OUT,cm} = 0.1 V p-p		36		MHz
-3 dB Large Signal Bandwidth	V _{OUT,cm} = 1 V p-p		29		MHz
Slew Rate	V _{OUT,cm} = 1 V p-p		52		V/μs
Input Voltage Noise	f = 100 kHz		83		nV/√Hz
Gain	ΔV _{OUT,cm} /ΔV _{OCM} , ΔV _{OCM} = ±1 V	0.99	1	1.01	V/V
V_{OCM} CHARACTERISTICS					
Input Common-Mode Voltage Range			-V _S + 0.8 to +V _S - 0.7		V
Input Resistance			250		kΩ
Offset Voltage	V _{OS,cm} = V _{OUT,cm} - V _{OCM} ; V _{IP} = V _{IN} = V _{OCM} = 0 V	-6	±1	+6	mV
Input Offset Voltage Drift	T _{MIN} to T _{MAX}		20		μV/°C
Input Bias Current		-7	+4	+7	μA
CMRR	ΔV _{OS,dm} /ΔV _{OCM} , ΔV _{OCM} = ±1 V	86	100		dB

General Performance

Table 5.

Parameter	Test Conditions/Comments	Min	Typ	Max	Unit
POWER SUPPLY					
Operating Range	LFCSP	3		7	V
	SOIC	3		6	V
Quiescent Current per Amplifier	Enabled	1.05	1.25	1.38	mA
Quiescent Current Drift	T _{MIN} to T _{MAX}		4.25		μA/°C
	Disabled		13.5	28.5	μA
+PSRR	ΔV _{OS,dm} /ΔV _S , ΔV _S = 1 V p-p	80	90		dB
-PSRR	ΔV _{OS,dm} /ΔV _S , ΔV _S = 1 V p-p	80	96		dB
DISABLE (DISABLE PIN)					
DISABLE Input Voltage	Disabled		≤(-V _S + 1)		V
	Enabled		≥(-V _S + 1.8)		V
Turn-Off Time			10		μs
Turn-On Time			0.6		μs
DISABLE Pin Bias Current per Amplifier					
Enabled	DISABLE = +2.5 V		2	5	μA
Disabled	DISABLE = -2.5 V	-10	-5		μA
OPERATING TEMPERATURE RANGE					
		-40		+125	°C

V_S = 3 V

V_{OCM} = Mid Supply, R_F = R_G = 1 kΩ, R_{L, dm} = 1 kΩ, T_A = 25°C, LFCSP package, unless otherwise noted. T_{MIN} to T_{MAX} = -40°C to +125°C.
(See Figure 61 for the definition of terms.)

+D_{IN} or -D_{IN} to V_{OUT, dm} Performance

Table 6.

Parameter	Test Conditions/Comments	Min	Typ	Max	Unit
DYNAMIC PERFORMANCE					
-3 dB Small Signal Bandwidth	V _{OUT, dm} = 0.1 V p-p		240		MHz
	V _{OUT, dm} = 0.1 V p-p, G = 2		200		MHz
	V _{OUT, dm} = 0.1 V p-p, G = 5		70		MHz
-3 dB Large Signal Bandwidth	V _{OUT, dm} = 2 V p-p		24		MHz
	V _{OUT, dm} = 2 V p-p, G = 2		20		MHz
	V _{OUT, dm} = 2 V p-p, G = 5		17		MHz
Bandwidth for 0.1 dB Flatness	V _{OUT, dm} = 0.1 V p-p		14		MHz
Slew Rate	V _{OUT, dm} = 2 V step		90		V/μs
Settling Time to 0.1%	V _{OUT, dm} = 2 V step		37		ns
Overdrive Recovery Time	G = 2, V _{IN, dm} = 3.6 V p-p, triangle wave		85		ns
NOISE/HARMONIC PERFORMANCE					
HD2/HD3	V _{OUT, dm} = 2 V p-p, f _c = 50 kHz (HD2/HD3)		-115/-121		dBc
	V _{OUT, dm} = 2 V p-p, f _c = 1 MHz (HD2/HD3)		-104/-96		dBc
IMD3	V _{OUT, dm} = 2 V p-p, f ₁ = 1.9 MHz, f ₂ = 2.1 MHz		-98		dBc
Input Voltage Noise	f = 100 kHz		3.9		nV/√Hz
Input Current Noise	f = 100 kHz		0.84		pA/√Hz
Crosstalk	V _{OUT, dm} = 2 V p-p, f _c = 1 MHz		-110		dB
INPUT CHARACTERISTICS					
Input Offset Voltage	V _{IP} = V _{IN} = V _{OCM} = 1.5 V	-0.4	±0.06	+0.4	mV
Input Offset Voltage Drift	T _{MIN} to T _{MAX}		1.2		μV/°C
Input Bias Current		-1.6	-1.1		μA
Input Bias Current Drift	T _{MIN} to T _{MAX}		-4.5		nA/°C
Input Offset Current		-500	±50	+500	nA
Input Common-Mode Voltage Range			-V _S - 0.2 to +V _S - 1.2		V
Input Resistance	Differential		33		kΩ
	Common mode		50		MΩ
Input Capacitance			1		pF
Common-Mode Rejection Ratio (CMRR)	ΔV _{OS, dm} /ΔV _{IN, cm} , ΔV _{IN, cm} = ±0.25 V dc	86	114		dB
Open-Loop Gain		91	99		dB
OUTPUT CHARACTERISTICS					
Output Voltage Swing	Each single-ended output	-V _S + 0.08 to +V _S - 0.08	-V _S + 0.04 to +V _S - 0.04		V
Linear Output Current	f = 1 MHz, R _{L, dm} = 26 Ω, SFDR = -60 dBc		38		mA peak
Output Balance Error	f = 1 MHz, ΔV _{OUT, cm} /ΔV _{OUT, dm}		-65	-60	dB

V_{OCM} to V_{OUT,cm} Performance

Table 7.

Parameter	Test Conditions/Comments	Min	Typ	Max	Unit
V_{OCM} DYNAMIC PERFORMANCE					
-3 dB Small Signal Bandwidth	V _{OUT,cm} = 0.1 V p-p		36		MHz
-3 dB Large Signal Bandwidth	V _{OUT,cm} = 1 V p-p		26		MHz
Slew Rate	V _{OUT,cm} = 1 V p-p		48		V/μs
Input Voltage Noise	f = 100 kHz		92		nV/√Hz
Gain	ΔV _{OUT,cm} /ΔV _{OCM} , ΔV _{OCM} = ±0.25 V	0.99	1	1.01	V/V
V_{OCM} CHARACTERISTICS					
Input Common-Mode Voltage Range			-V _S + 0.8 to +V _S - 0.7		V
Input Resistance			250		kΩ
Offset Voltage	V _{OS,cm} = V _{OUT,cm} - V _{OCM} ; V _{IP} = V _{IN} = V _{OCM} = 1.5 V	-7	±1	+7	mV
Input Offset Voltage Drift	T _{MIN} to T _{MAX}		20		μV/°C
Input Bias Current		-5	+1	+5	μA
CMRR	ΔV _{OS,dm} /ΔV _{OCM} , ΔV _{OCM} = ±0.25 V	80	100		dB

General Performance

Table 8.

Parameter	Test Conditions/Comments	Min	Typ	Max	Unit
POWER SUPPLY					
Operating Range	LFCSP	3		7	V
	SOIC	3		6	V
Quiescent Current per Amplifier	Enabled	1	1.18	1.33	mA
	T _{MIN} to T _{MAX}		4.25		μA/°C
	Disabled		7	22	μA
+PSRR	ΔV _{OS,dm} /ΔV _S , ΔV _S = 0.25 V p-p	80	90		dB
-PSRR	ΔV _{OS,dm} /ΔV _S , ΔV _S = 0.25 V p-p	80	96		dB
DISABLE (DISABLE PIN)					
DISABLE Input Voltage	Disabled		≤(-V _S + 1)		V
	Enabled		≥(-V _S + 1.8)		V
Turn-Off Time			16		μs
Turn-On Time			0.6		μs
DISABLE Pin Bias Current per Amplifier					
Enabled	DISABLE = +3 V		0.3	1	μA
Disabled	DISABLE = 0 V	-6	-3		μA
OPERATING TEMPERATURE RANGE					
		-40		+125	°C

ABSOLUTE MAXIMUM RATINGS

Table 9.

Parameter	Rating
Supply Voltage	8 V
V_{OCM}	$\pm V_S$
Differential Input Voltage	1.2 V
Operating Temperature Range	-40°C to +125°C
Storage Temperature Range	-65°C to +150°C
Lead Temperature (Soldering, 10 sec)	300°C
Junction Temperature	150°C
ESD	
Field Induced Charged Device Model (FICDM)	1250 V
Human Body Model (HBM)	2000 V

Stresses above those listed under Absolute Maximum Ratings may cause permanent damage to the device. This is a stress rating only; functional operation of the device at these or any other conditions above those indicated in the operational section of this specification is not implied. Exposure to absolute maximum rating conditions for extended periods may affect device reliability.

THERMAL RESISTANCE

θ_{JA} is specified for the worst-case conditions, that is, θ_{JA} is specified for the device soldered on a circuit board in still air.

Table 10.

Package Type	θ_{JA}	Unit
8-Lead SOIC (Single)/4-Layer Board	158	°C/W
16-Lead LFCSP (Single)/4-Layer Board	91.3	°C/W
24-Lead LFCSP (Dual)/4-Layer Board	65.1	°C/W

MAXIMUM POWER DISSIPATION

The maximum safe power dissipation in the [ADA4940-1/ADA4940-2](#) packages is limited by the associated rise in junction temperature (T_j) on the die. At approximately 150°C, which is the glass transition temperature, the plastic changes its properties. Even temporarily exceeding this temperature limit can change the stresses that the package exerts on the die, permanently shifting the parametric performance of the [ADA4940-1/ADA4940-2](#). Exceeding a junction temperature of 150°C for an extended period can result in changes in the silicon devices, potentially causing failure.

The power dissipated in the package (P_D) is the sum of the quiescent power dissipation and the power dissipated in the package due to the load drive for all outputs. The quiescent power dissipation is the voltage between the supply pins ($\pm V_S$) times the quiescent current (I_S). The load current consists of the differential and common-mode currents flowing to the load, as well as currents flowing through the external feedback networks and internal common-mode feedback loop. The internal resistor tap used in the common-mode feedback loop places a negligible differential load on the output. RMS voltages and currents should be considered when dealing with ac signals.

Airflow reduces θ_{JA} . In addition, more metal directly in contact with the package leads from metal traces, through holes, ground, and power planes reduces the θ_{JA} .

Figure 3 shows the maximum safe power dissipation in the package vs. the ambient temperature for the 8-lead SOIC ($\theta_{JA} = 158^\circ\text{C/W}$, single) the 16-lead LFCSP ($\theta_{JA} = 91.3^\circ\text{C/W}$, single) and 24-lead LFCSP ($\theta_{JA} = 65.1^\circ\text{C/W}$, dual) packages on a JEDEC standard 4-layer board. θ_{JA} values are approximations.

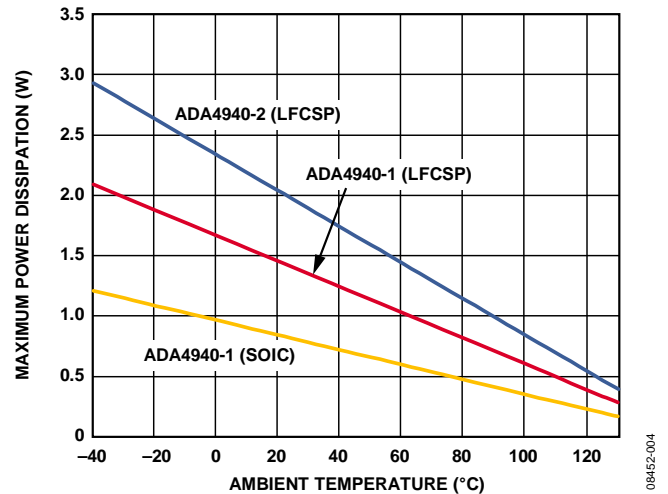

Figure 3. Maximum Safe Power Dissipation vs. Ambient Temperature

ESD CAUTION



ESD (electrostatic discharge) sensitive device. Charged devices and circuit boards can discharge without detection. Although this product features patented or proprietary protection circuitry, damage may occur on devices subjected to high energy ESD. Therefore, proper ESD precautions should be taken to avoid performance degradation or loss of functionality.

PIN CONFIGURATIONS AND FUNCTION DESCRIPTIONS

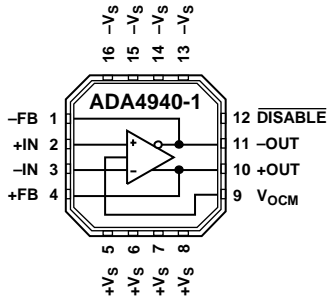

NOTES
1. CONNECT THE EXPOSED PAD TO -V_S OR GROUND.

08452-101

Figure 4. ADA4940-1 Pin Configuration (16-Lead LFCSP)

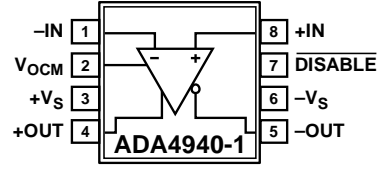

08452-003

Figure 5. ADA4940-1 Pin Configuration (SOIC)

Table 11. ADA4940-1 Pin Function Descriptions (16-Lead LFCSP)

Pin No.	Mnemonic	Description
1	-FB	Negative Output for Feedback Component Connection.
2	+IN	Positive Input Summing Node.
3	-IN	Negative Input Summing Node.
4	+FB	Positive Output for Feedback Component Connection.
5 to 8	+V _S	Positive Supply Voltage.
9	V _{OCM}	Output Common-Mode Voltage.
10	+OUT	Positive Output for Load Connection.
11	-OUT	Negative Output for Load Connection.
12	DISABLE	Disable Pin.
13 to 16	-V _S	Negative Supply Voltage.
	Exposed paddle (EPAD)	Connect the exposed pad to -V _S or ground.

Table 12. ADA4940-1 Pin Function Descriptions (8-Lead SOIC)

Pin No.	Mnemonic	Description
1	-IN	Negative Input Summing Node.
2	V _{OCM}	Output Common-Mode Voltage.
3	+V _S	Positive Supply Voltage.
4	+OUT	Positive Output for Load Connection.
5	-OUT	Negative Output for Load Connection.
6	-V _S	Negative Supply Voltage.
7	DISABLE	Disable Pin.
8	+IN	Positive Input Summing Node.

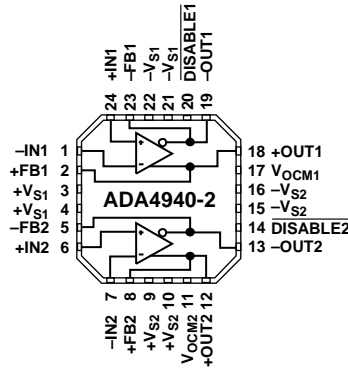

NOTES
 1. CONNECT THE EXPOSED PAD TO $-V_S$ OR GROUND.

08452-102

Figure 6. ADA4940-2 Pin Configuration (24-Lead LFCSP)

Table 13. ADA4940-2 Pin Function Descriptions (24-Lead LFCSP)

Pin No.	Mnemonic	Description
1	-IN1	Negative Input Summing Node 1.
2	+FB1	Positive Output Feedback Pin 1.
3, 4	+VS1	Positive Supply Voltage 1.
5	-FB2	Negative Output Feedback Pin 2.
6	+IN2	Positive Input Summing Node 2.
7	-IN2	Negative Input Summing Node 2.
8	+FB2	Positive Output Feedback Pin 2.
9, 10	+VS2	Positive Supply Voltage 2.
11	V _{OCM2}	Output Common-Mode Voltage 2.
12	+OUT2	Positive Output 2.
13	-OUT2	Negative Output 2.
14	DISABLE2	Disable Pin 2.
15, 16	-VS2	Negative Supply Voltage 2.
17	V _{OCM1}	Output Common-Mode Voltage 1.
18	+OUT1	Positive Output 1.
19	-OUT1	Negative Output 1.
20	DISABLE1	Disable Pin 1.
21, 22	-VS1	Negative Supply Voltage 1.
23	-FB1	Negative Output Feedback Pin 1.
24	+IN1	Positive Input Summing Node 1.
	Exposed paddle (EPAD)	Connect the exposed pad to $-V_S$ or ground.

TYPICAL PERFORMANCE CHARACTERISTICS

$T_A = 25^\circ\text{C}$, $V_S = \pm 2.5\text{ V}$, $G = 1$, $R_F = R_G = 1\text{ k}\Omega$, $R_T = 52.3\ \Omega$ (when used), $R_L = 1\text{ k}\Omega$, unless otherwise noted. See Figure 59 and Figure 60 for the test circuits.

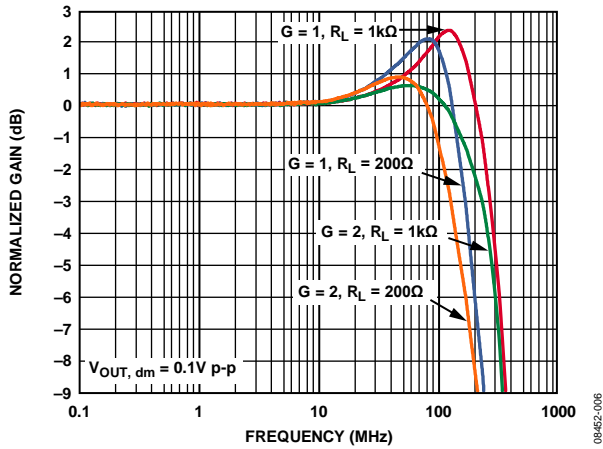

Figure 7. Small Signal Frequency Response for Various Gains and Loads (LFCSF)

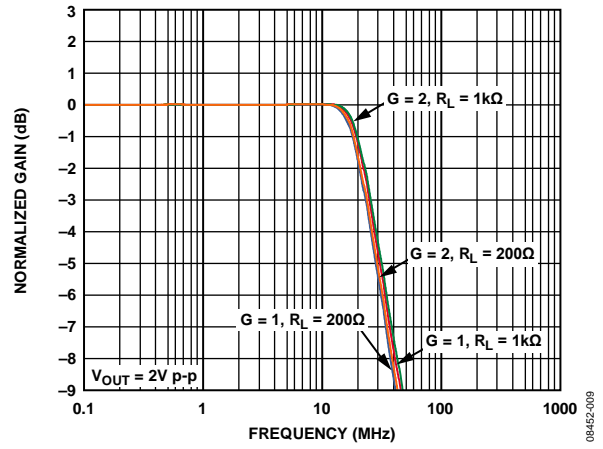

Figure 10. Large Signal Frequency Response for Various Gains and Loads

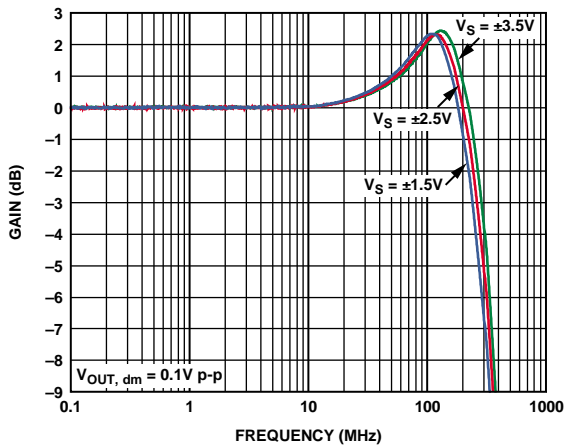

Figure 8. Small Signal Frequency Response for Various Supplies (LFCSF)

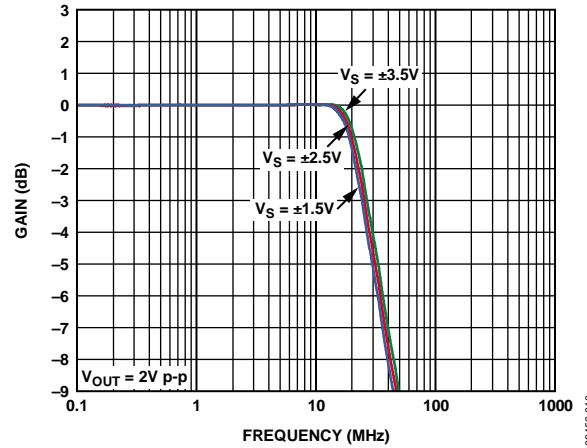

Figure 11. Large Signal Frequency Response for Various Supplies

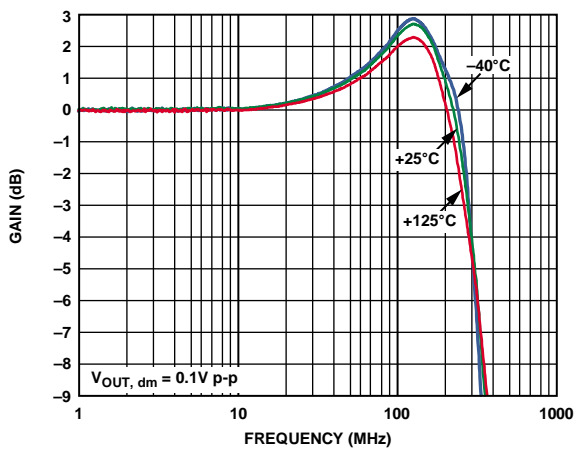

Figure 9. Small Signal Frequency Response for Various Temperatures (LFCSF)

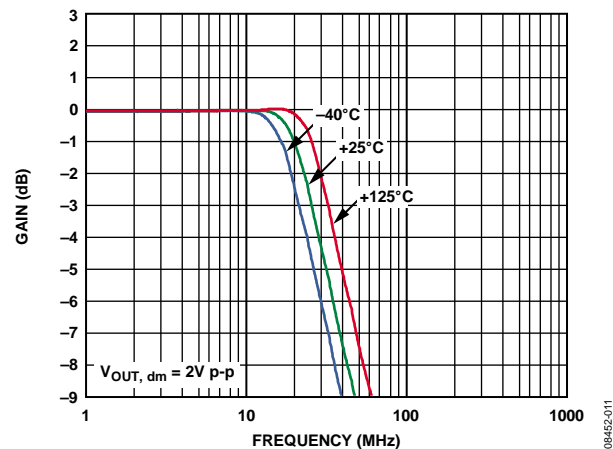

Figure 12. Large Signal Frequency Response for Various Temperatures

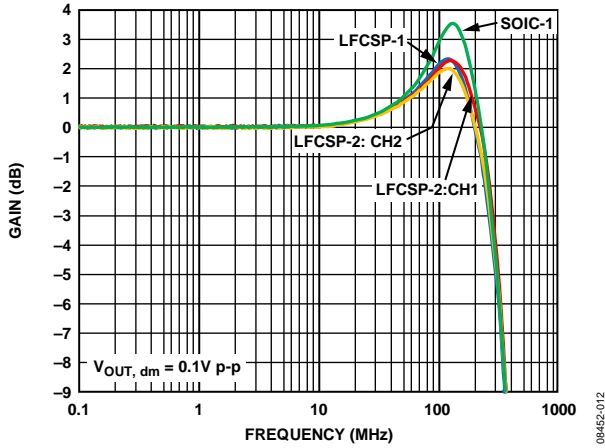

Figure 13. Small Signal Frequency Response for Various Packages

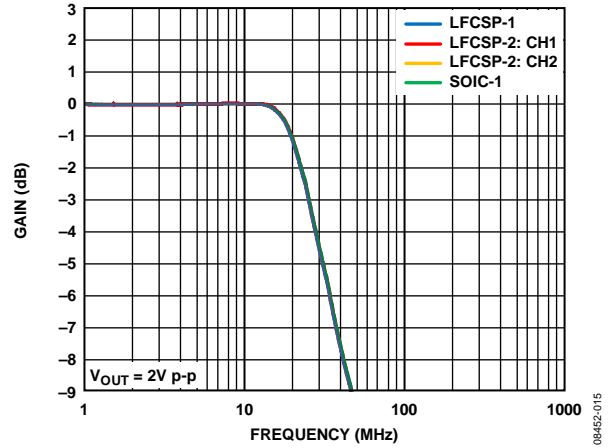

Figure 16. Large Signal Frequency Response for Various Packages

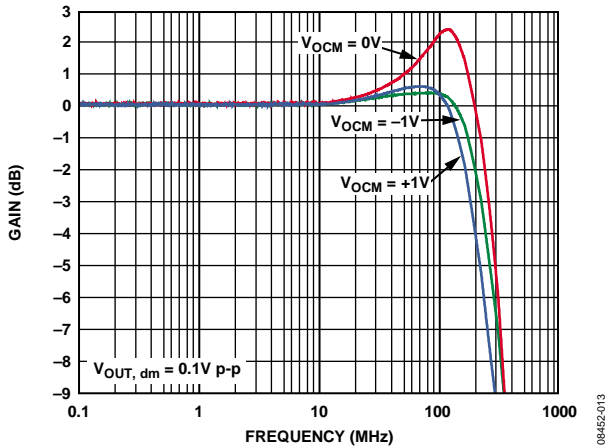

Figure 14. Small Signal Frequency Response at Various V_{OCM} Levels (LFCSP)

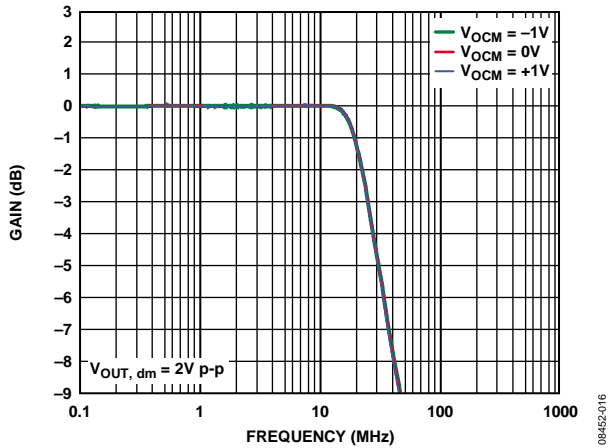

Figure 17. Large Signal Frequency Response at Various V_{OCM} Levels

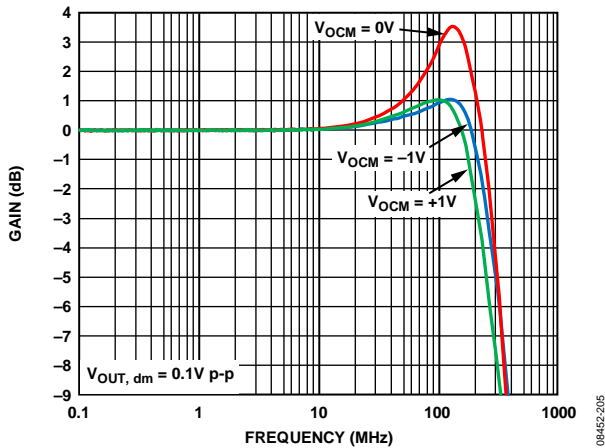

Figure 15. Small Signal Frequency Response for Various V_{OCM} (SOIC)

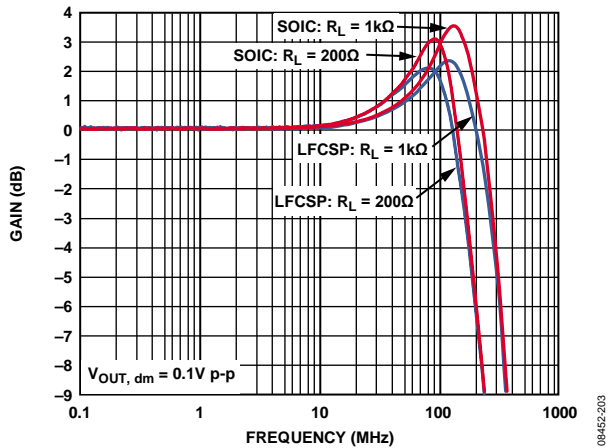

Figure 18. Small Signal Frequency Response for Various Packages and Loads

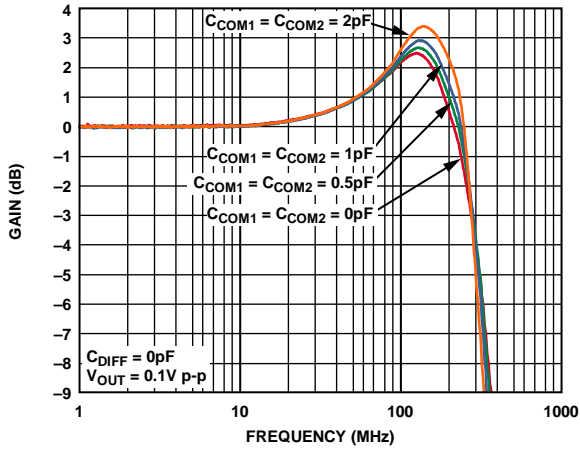

Figure 19. Small Signal Frequency Response for Various Capacitive Loads (LFCSF)

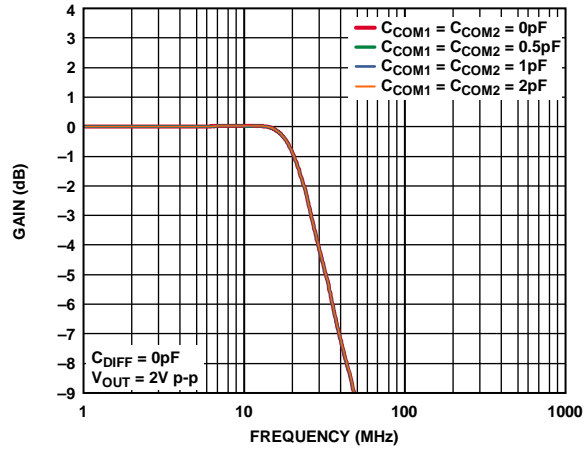

Figure 22. Large Signal Frequency Response for Various Capacitive Loads

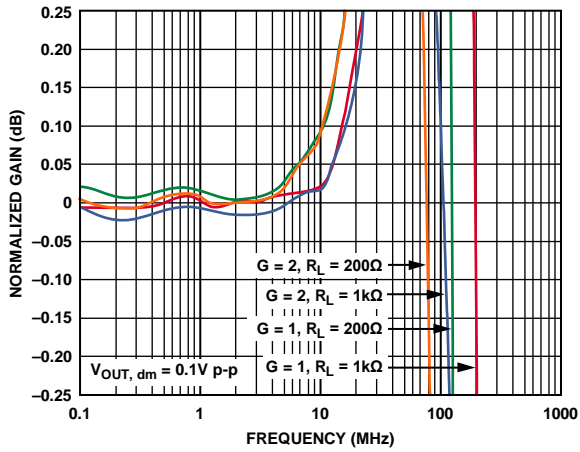

Figure 20. 0.1 dB Flatness Small Signal Frequency Response for Various Gains and Loads (LFCSF)

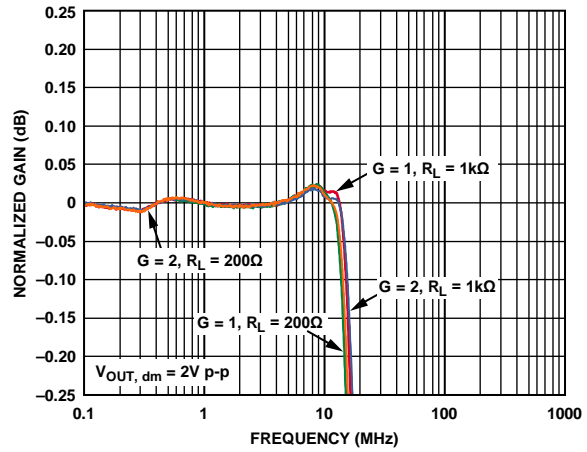

Figure 23. 0.1 dB Flatness Large Signal Frequency Response for Various Gains and Loads

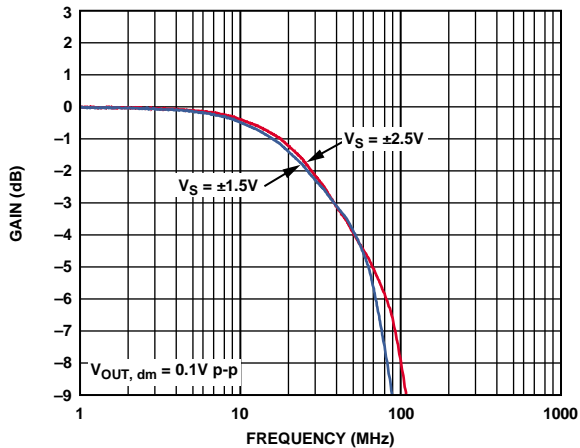

Figure 21. V_{OCM} Small Signal Frequency Response for Various Supplies

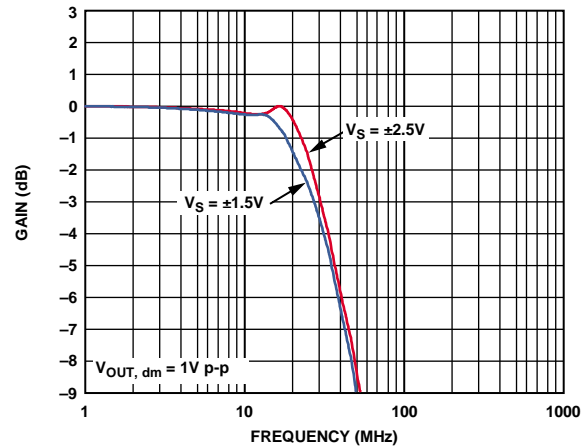

Figure 24. V_{OCM} Large Signal Frequency Response for Various Supplies

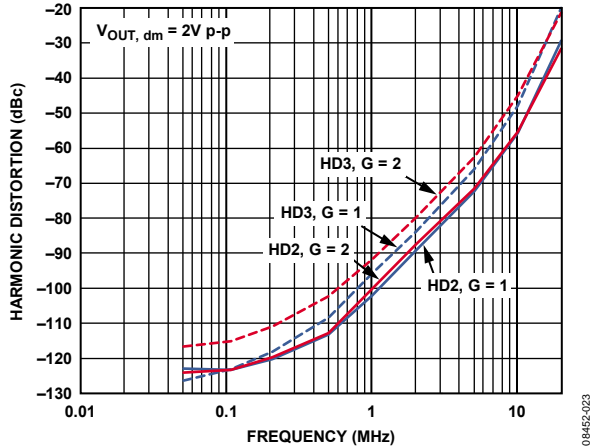

Figure 25. Harmonic Distortion vs. Frequency for Various Gains (LFCSP)

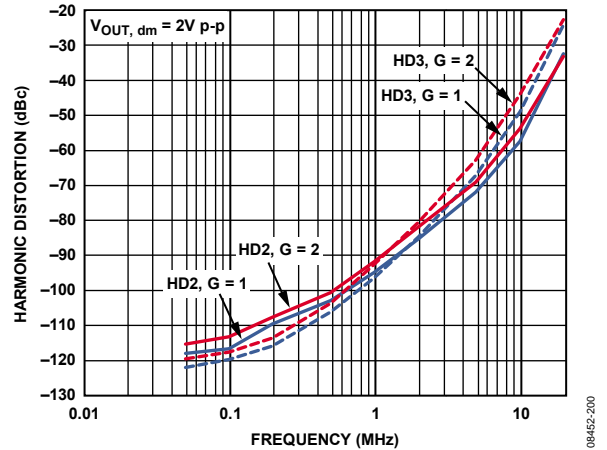

Figure 28. Harmonic Distortion vs. Frequency vs. Gain (SOIC)

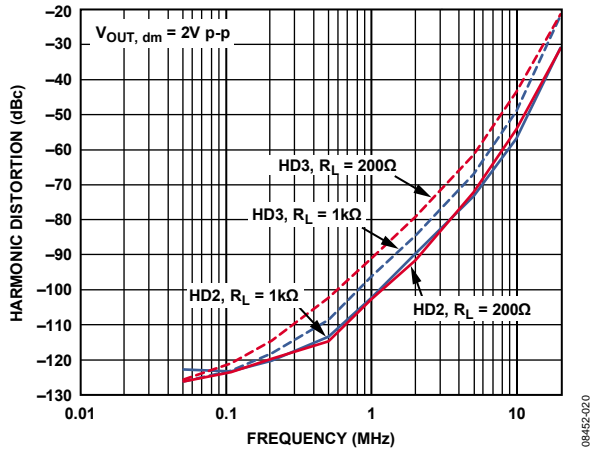

Figure 26. Harmonic Distortion vs. Frequency for Various Loads (LFCSP)

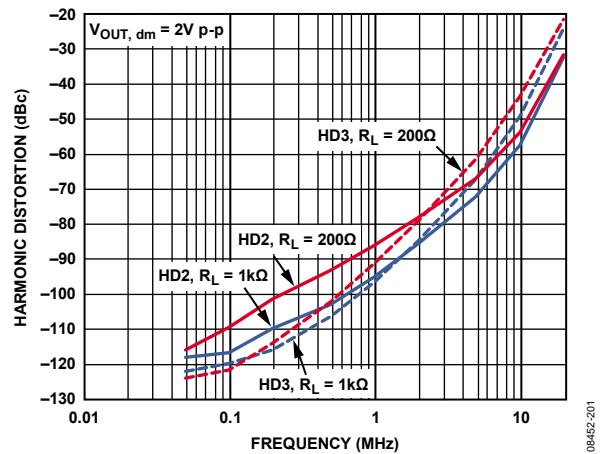

Figure 29. Harmonic Distortion vs. Frequency for Various Loads (SOIC)

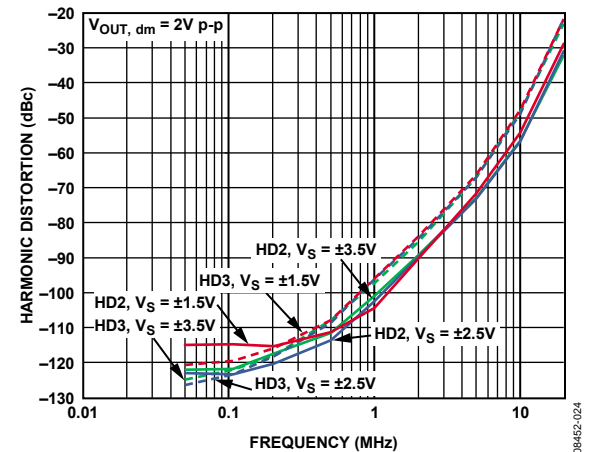

Figure 27. Harmonic Distortion vs. Frequency for Various Supplies (LFCSP)

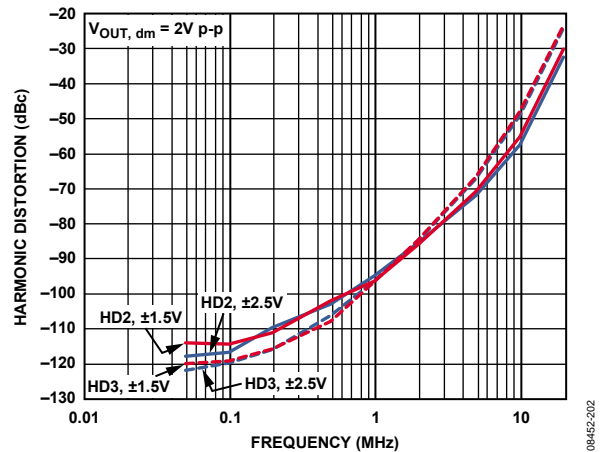

Figure 30. Harmonic Distortion vs. Frequency for Various Supplies (SOIC)

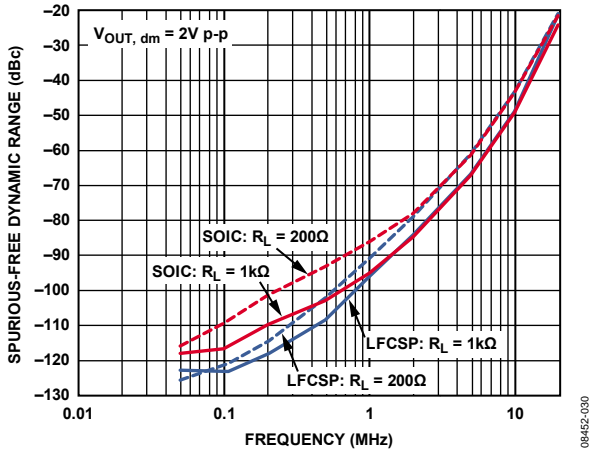

Figure 31. Spurious-Free Dynamic Range vs. Frequency at $R_L = 200\ \Omega$ and $R_L = 1\ \text{k}\Omega$

08452-030

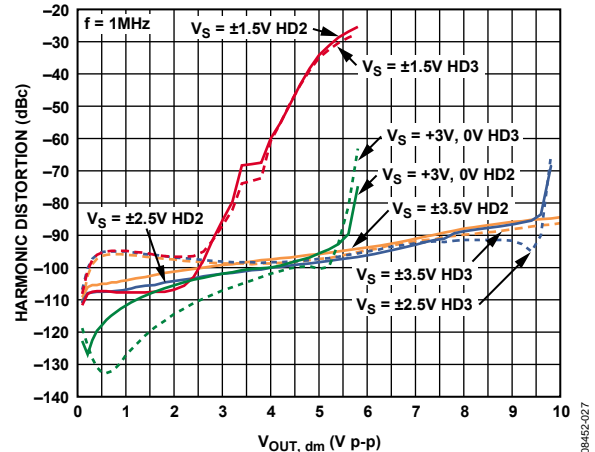

Figure 34. Harmonic Distortion vs. $V_{OUT, dm}$ for Various Supplies, $f = 1\ \text{MHz}$ (LFCSP)

08452-027

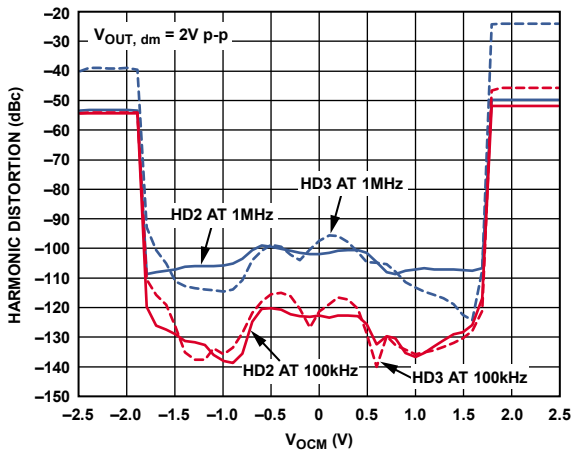

Figure 32. Harmonic Distortion vs. V_{OCM} for 100 kHz and 1 MHz, $\pm 2.5\ \text{V}$ Supplies (LFCSP)

08452-025

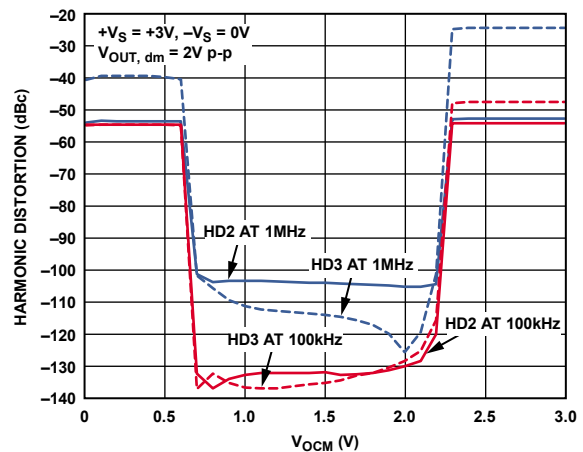

Figure 35. Harmonic Distortion vs. V_{OCM} for 100 kHz and 1 MHz, 3V Supply (LFCSP)

08452-028

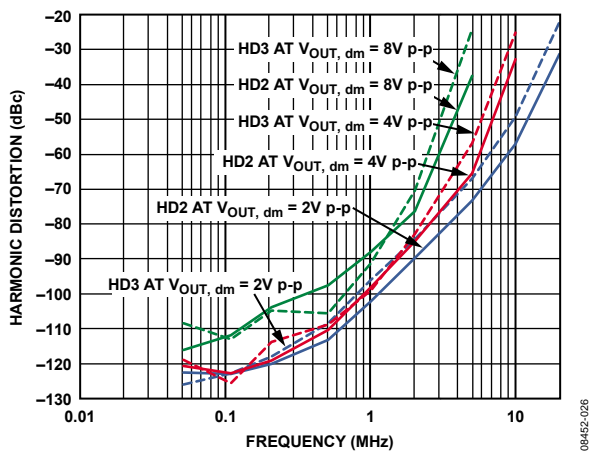

Figure 33. Harmonic Distortion vs. Frequency for Various $V_{OUT, dm}$ (LFCSP)

08452-026

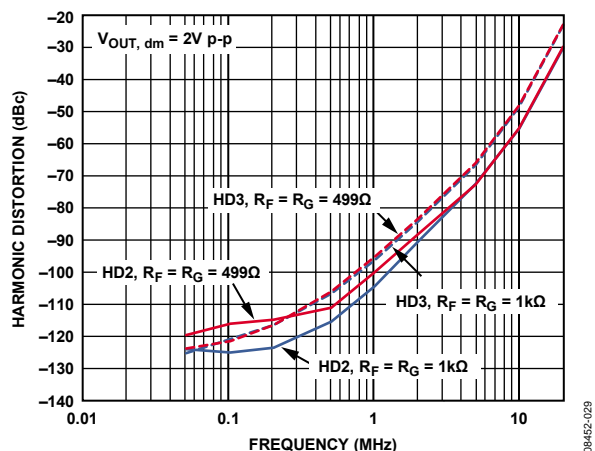

Figure 36. Harmonic Distortion vs. Frequency for Various R_F and R_G (LFCSP)

08452-023

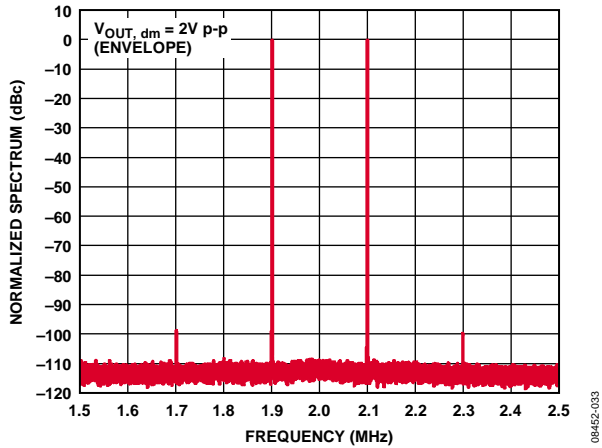

Figure 37. 2 MHz Intermodulation Distortion (LFCSP)

084452-0033

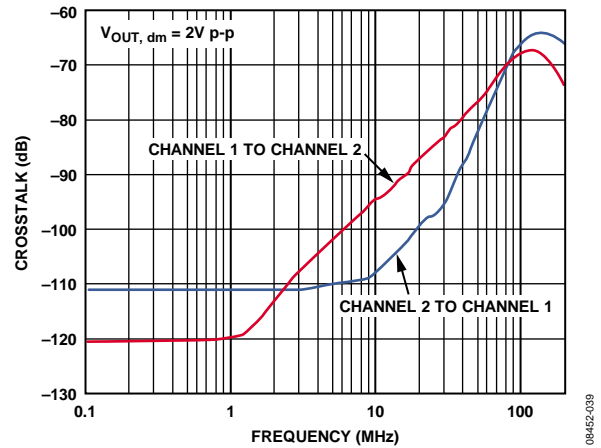

Figure 40. Crosstalk vs. Frequency, ADA4940-2

084452-0309

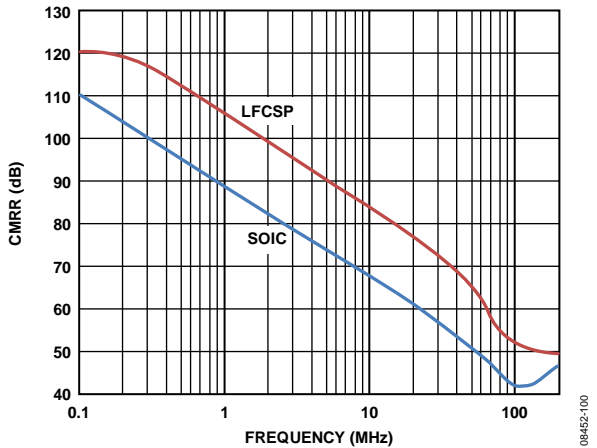

Figure 38. CMRR vs. Frequency

084452-1000

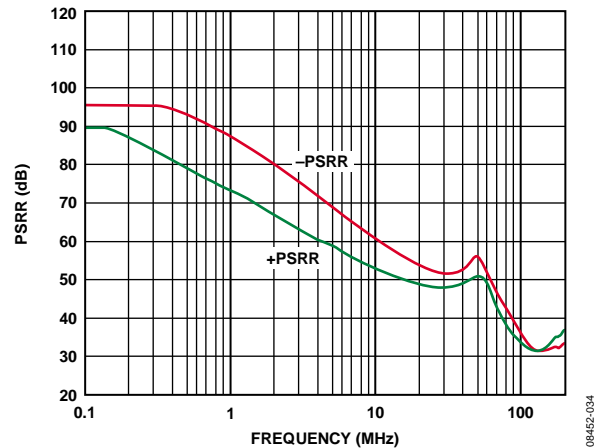

Figure 41. PSRR vs. Frequency

084452-0304

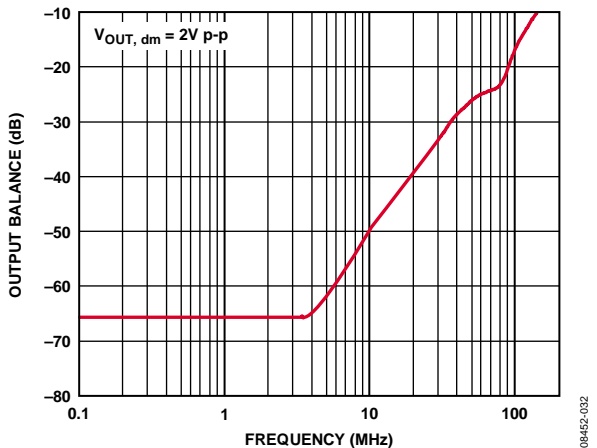

Figure 39. Output Balance vs. Frequency

084452-0032

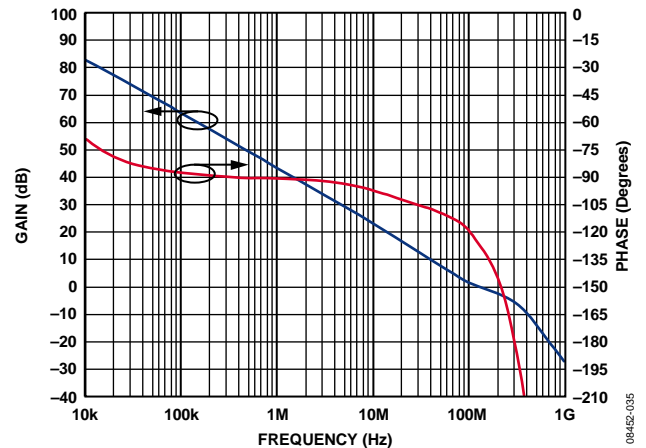

Figure 42. Open-Loop Gain and Phase vs. Frequency

084452-0035

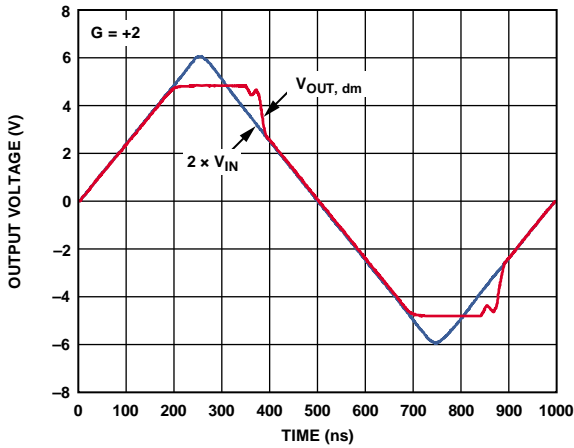

Figure 43. Output Overdrive Recovery, $G = 2$

08452-041

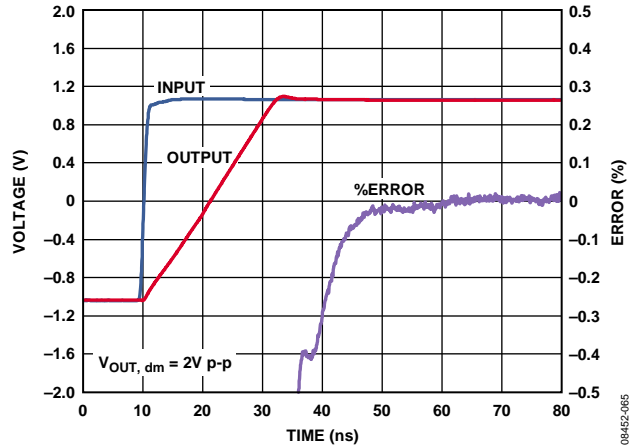

Figure 46. 0.1% Settling Time

08452-065

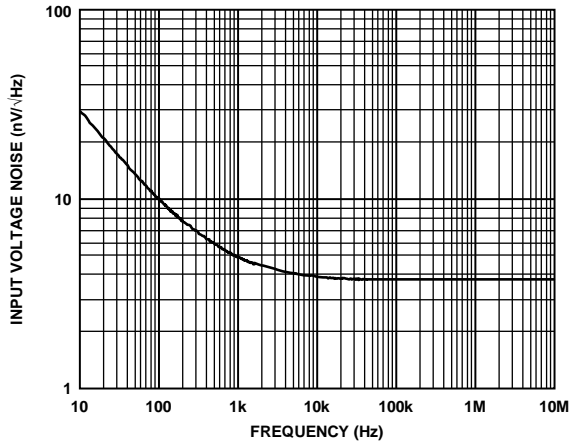

Figure 44. Voltage Noise Spectral Density, Referred to Input

08452-037

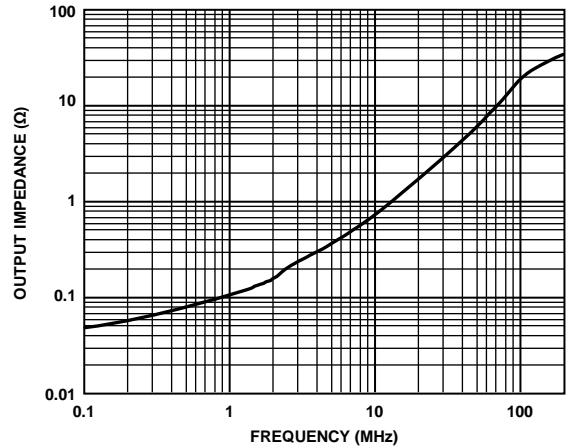

Figure 47. Closed-Loop Output Impedance Magnitude vs. Frequency, $G = 1$

08452-040

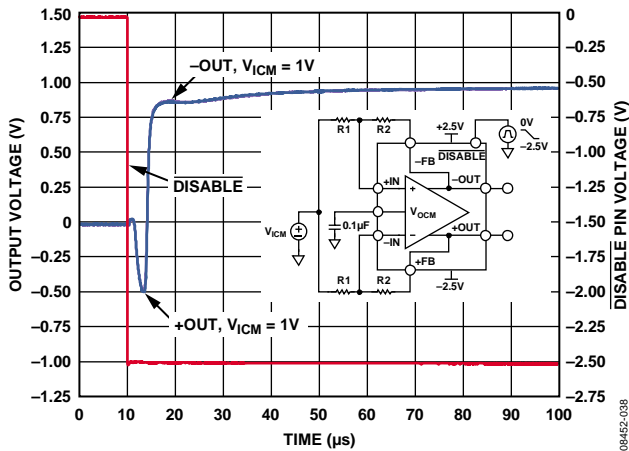

Figure 45. $\overline{\text{DISABLE}}$ Pin Turn-Off Time

08452-038

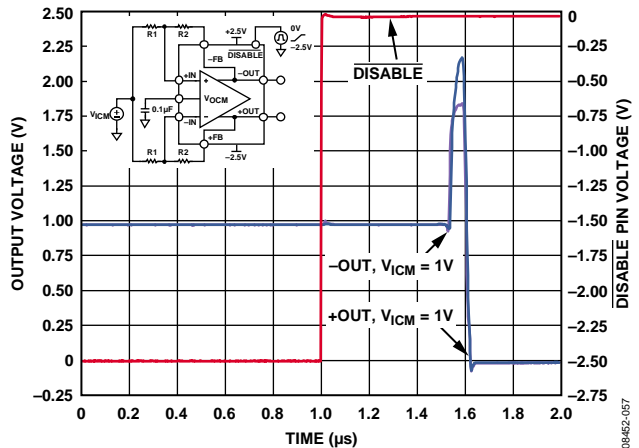

Figure 48. $\overline{\text{DISABLE}}$ Pin Turn-On Time

08452-057

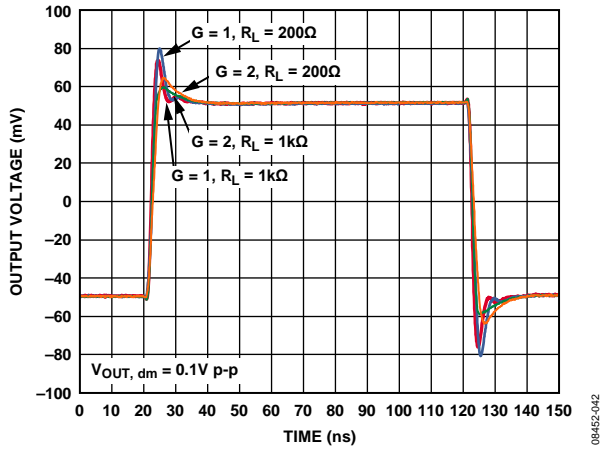

Figure 49. Small Signal Transient Response for Various Gains and Loads (LFCSF)

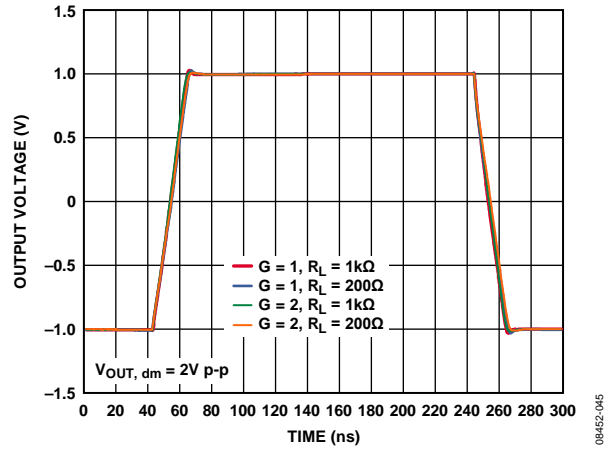

Figure 52. Large Signal Transient Response for Various Gains and Loads

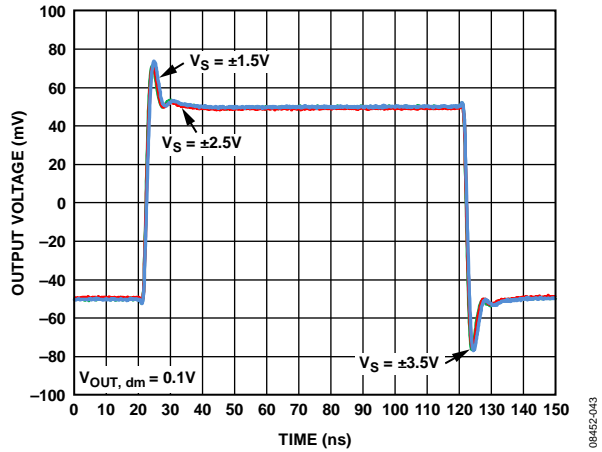

Figure 50. Small Signal Transient Response for Various Supplies (LFCSF)

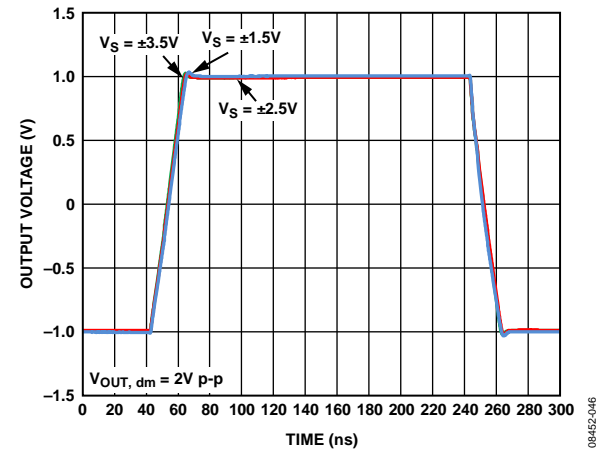

Figure 53. Large Signal Transient Response for Various Supplies

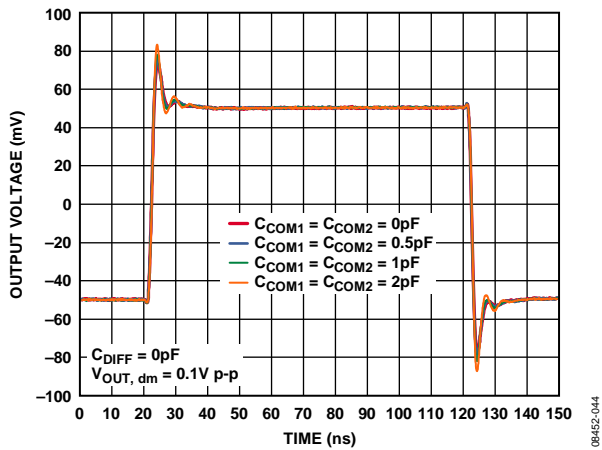

Figure 51. Small Signal Transient Response for Various Capacitive Loads (LFCSF)

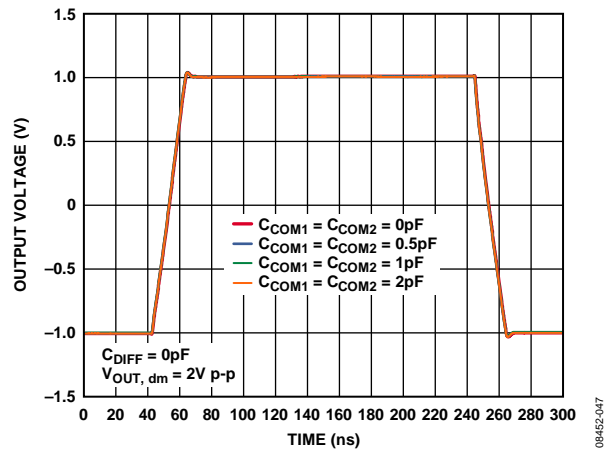

Figure 54. Large Signal Transient Response for Various Capacitive Loads

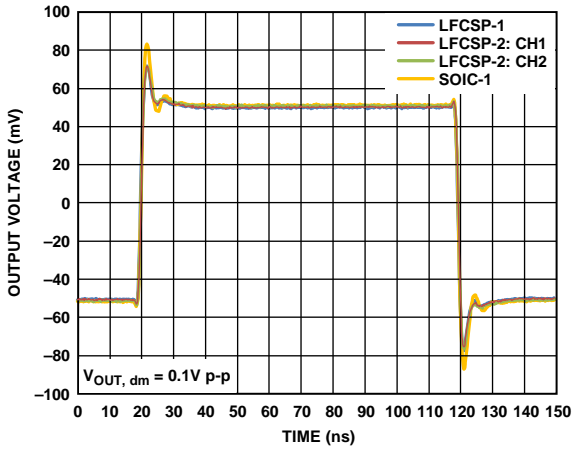

Figure 55. Small Signal Transient Response for Various Packages, $C_L = 0$ pF

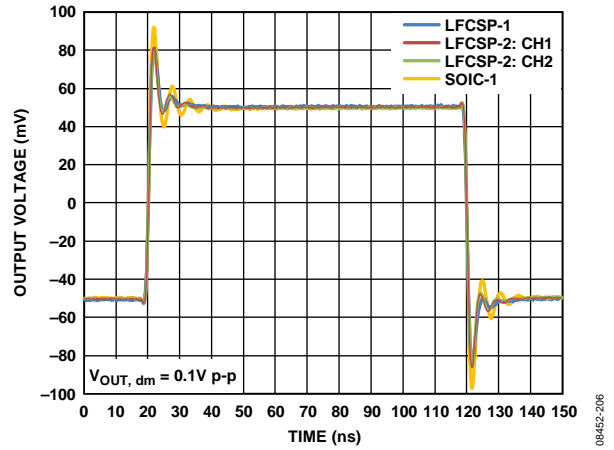

Figure 57. Small Signal Transient Response for Various Packages, $C_L = 2$ pF

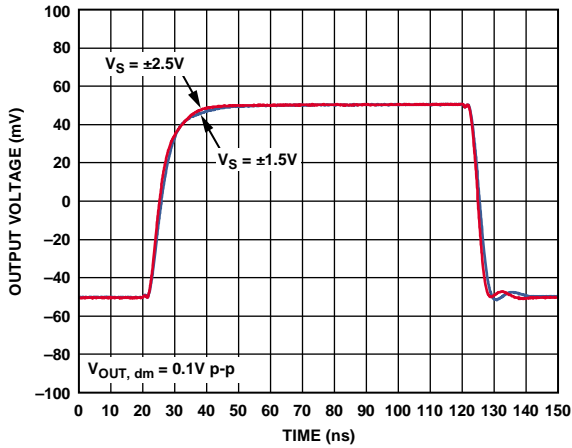

Figure 56. V_{OCM} Small Signal Transient Response

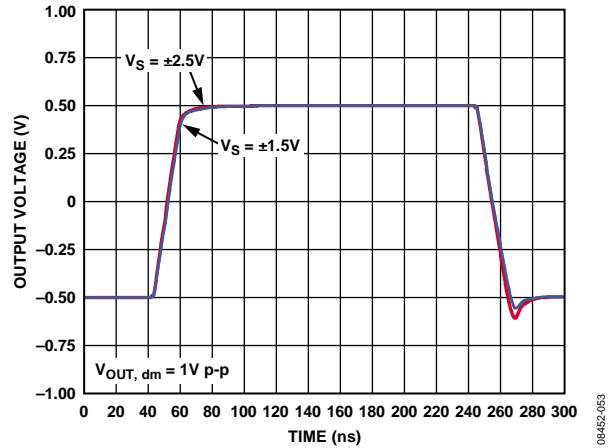

Figure 58. V_{OCM} Large Signal Transient Response

TEST CIRCUITS

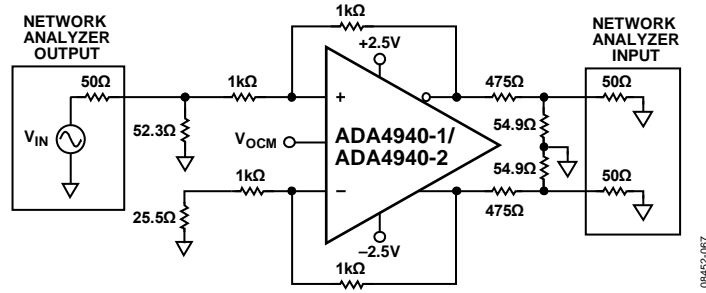

Figure 59. Equivalent Basic Test Circuit

08462-067

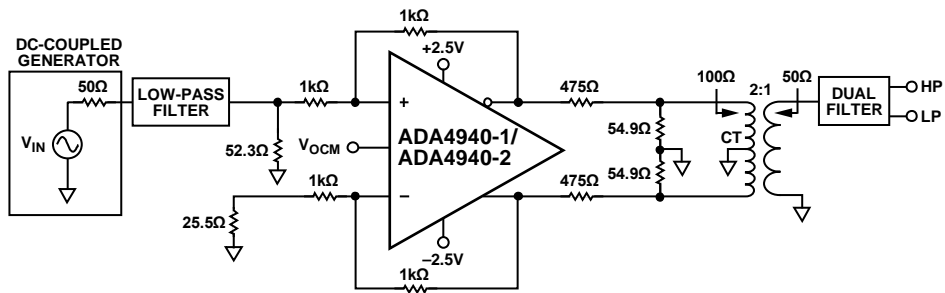

Figure 60. Test Circuit for Distortion Measurements

08462-066

TERMINOLOGY

DEFINITION OF TERMS

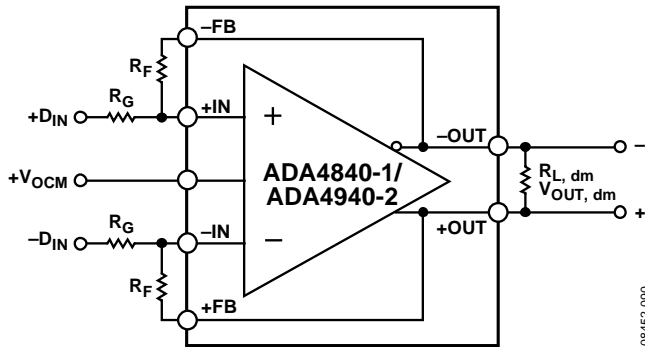

Figure 61. Circuit Definitions

08452-090

Differential Voltage

Differential voltage refers to the difference between two node voltages. For example, the differential output voltage (or equivalently, output differential mode voltage) is defined as

$$V_{OUT, dm} = (V_{+OUT} - V_{-OUT})$$

where V_{+OUT} and V_{-OUT} refer to the voltages at the +OUT and -OUT terminals with respect to a common reference.

Similarly, the differential input voltage is defined as

$$V_{IN, dm} = (+D_{IN} - (-D_{IN}))$$

Common-Mode Voltage (CMV)

CMV refers to the average of two node voltages. The output common-mode voltage is defined as

$$V_{OUT, cm} = (V_{+OUT} + V_{-OUT})/2$$

Similarly, the input common-mode voltage is defined as

$$V_{IN, cm} = (+D_{IN} + (-D_{IN}))/2$$

Common-Mode Offset Voltage

The common-mode offset voltage is defined as the difference between the voltage applied to the V_{OCM} terminal and the common mode of the output voltage.

$$V_{OS, cm} = V_{OUT, cm} - V_{OCM}$$

Differential V_{OS} , Differential CMRR, and V_{OCM} CMRR

The differential mode and common-mode voltages each have their own error sources. The differential offset ($V_{OS, dm}$) is the voltage error between the +IN and -IN terminals of the amplifier. Differential CMRR reflects the change of $V_{OS, dm}$ in response to changes to the common-mode voltage at the input terminals +D_{IN} and -D_{IN}.

$$CMRR_{DIFF} = \frac{\Delta V_{IN, cm}}{\Delta V_{OS, dm}}$$

V_{OCM} CMRR reflects the change of $V_{OS, dm}$ in response to changes to the common-mode voltage at the output terminals.

$$CMRR_{V_{OCM}} = \frac{\Delta V_{OCM}}{\Delta V_{OS, dm}}$$

Balance

Balance is a measure of how well the differential signals are matched in amplitude; the differential signals are exactly 180° apart in phase. By this definition, the output balance is the magnitude of the output common-mode voltage divided by the magnitude of the output differential mode voltage.

$$Output\ Balance\ Error = \left| \frac{V_{OUT, cm}}{V_{OUT, dm}} \right|$$

THEORY OF OPERATION

The ADA4940-1/ADA4940-2 are high speed, low power differential amplifiers fabricated on Analog Devices advanced dielectrically isolated SiGe bipolar process. They provide two closely balanced differential outputs in response to either differential or single-ended input signals. An external feedback network that is similar to a voltage feedback operational amplifier sets the differential gain. The output common-mode voltage is independent of the input common-mode voltage and is set by an external voltage at the V_{OCM} terminal. The PNP input stage allows input common-mode voltages between the negative supply and 1.2 V below the positive supply. A rail-to-rail output stage supplies a wide output voltage range. The DISABLE pin can be used to reduce the supply current of the amplifier to 13.5 μA.

Figure 62 shows the ADA4940-1/ADA4940-2 architecture. The differential feedback loop consists of the differential transconductance G_{DIFF} working through the G_O output buffers and the R_F/R_G feedback networks. The common-mode feedback loop is set up with a voltage divider across the two differential outputs to create an output voltage midpoint and a common-mode transconductance, G_{CM}.

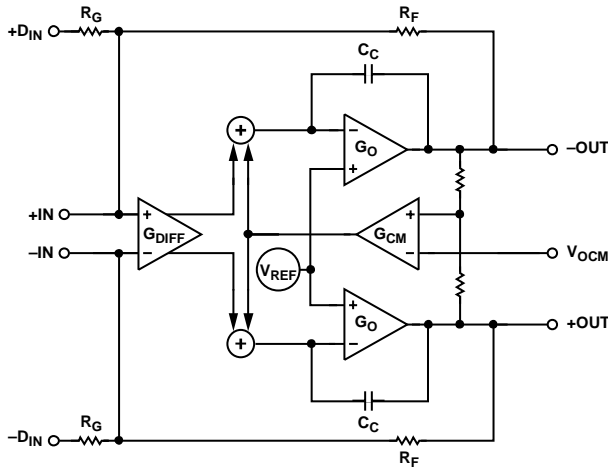

Figure 62. ADA4940-1/ADA4940-2 Architectural Block

The differential feedback loop forces the voltages at +IN and -IN to equal each other. This fact sets the following relationships:

$$\frac{+D_{IN}}{R_G} = -\frac{V_{-OUT}}{R_F}$$

$$\frac{-D_{IN}}{R_G} = -\frac{V_{+OUT}}{R_F}$$

Subtracting the previous equations gives the relationship that shows R_F and R_G setting the differential gain.

$$(V_{+OUT} - V_{-OUT}) = (+D_{IN} - (-D_{IN})) \times \frac{R_F}{R_G}$$

The common-mode feedback loop drives the output common-mode voltage that is sampled at the midpoint of the output voltage divider to equal the voltage at V_{OCM}. This results in the following relationships:

$$V_{+OUT} = V_{OCM} + \frac{V_{OUT,dm}}{2}$$

$$V_{-OUT} = V_{OCM} - \frac{V_{OUT,dm}}{2}$$

Note that the differential amplifier's summing junction input voltages, +IN and -IN, are set by both the output voltages and the input voltages.

$$V_{+IN} = +D_{IN} \left(\frac{R_F}{R_F + R_G} \right) + V_{-OUT} \left(\frac{R_G}{R_F + R_G} \right)$$

$$V_{-IN} = -D_{IN} \left(\frac{R_F}{R_F + R_G} \right) + V_{+OUT} \left(\frac{R_G}{R_F + R_G} \right)$$

APPLICATIONS INFORMATION

ANALYZING AN APPLICATION CIRCUIT

The ADA4940-1/ADA4940-2 use open-loop gain and negative feedback to force their differential and common-mode output voltages in such a way as to minimize the differential and common-mode error voltages. The differential error voltage is defined as the voltage between the differential inputs labeled +IN and -IN (see Figure 61). For most purposes, this voltage can be assumed to be zero. Similarly, the difference between the actual output common-mode voltage and the voltage applied to V_{OCM} can also be assumed to be zero. Starting from these two assumptions, any application circuit can be analyzed.

SETTING THE CLOSED-LOOP GAIN

The differential mode gain of the circuit in Figure 61 can be determined by

$$\left| \frac{V_{OUT, dm}}{V_{IN, dm}} \right| = \frac{R_F}{R_G}$$

This assumes that the input resistors (R_G) and feedback resistors (R_F) on each side are equal.

ESTIMATING THE OUTPUT NOISE VOLTAGE

The differential output noise of the ADA4940-1/ADA4940-2 can be estimated using the noise model in Figure 63. The input-referred noise voltage density, v_{nIN}, is modeled as a differential input, and the noise currents, i_{nIN-} and i_{nIN+}, appear between each input and ground. The noise currents are assumed to be equal and produce a voltage across the parallel combination of the gain and feedback resistances. v_{nCM} is the noise voltage density at the V_{OCM} pin. Each of the four resistors contributes (4kTR_x)^{1/2}. Table 14 summarizes the input noise sources, the multiplication factors, and the output-referred noise density terms. For more noise calculation information, go to the Analog Devices Differential Amplifier Calculator ([DiffAmpCalc™](#)), click [ADIDiffAmpCalculator.zip](#) and follow the on-screen prompts.

Table 14. Output Noise Voltage Density Calculations

Input Noise Contribution	Input Noise Term	Input Noise Voltage Density	Output Multiplication Factor	Output-Referred Noise Voltage Density Term
Differential Input	v _{nIN}	v _{nIN}	G _N	v _{nO1} = G _N (v _{nIN})
Inverting Input	i _{nIN-}	i _{nIN-} × (R _{G2} R _{F2})	G _N	v _{nO2} = G _N [i _{nIN-} × (R _{G2} R _{F2})]
Noninverting Input	i _{nIN+}	i _{nIN+} × (R _{G1} R _{F1})	G _N	v _{nO3} = G _N [i _{nIN+} × (R _{G1} R _{F1})]
V _{OCM} Input	v _{nCM}	v _{nCM}	G _N (β ₁ - β ₂)	v _{nO4} = G _N (β ₁ - β ₂) (v _{nCM})
Gain Resistor R _{G1}	v _{nRG1}	(4kTR _{G1}) ^{1/2}	G _N (1 - β ₂)	v _{nO5} = G _N (1 - β ₂) (4kTR _{G1}) ^{1/2}
Gain Resistor R _{G2}	v _{nRG2}	(4kTR _{G2}) ^{1/2}	G _N (1 - β ₁)	v _{nO6} = G _N (1 - β ₁) (4kTR _{G2}) ^{1/2}
Feedback Resistor R _{F1}	v _{nRF1}	(4kTR _{F1}) ^{1/2}	1	v _{nO7} = (4kTR _{F1}) ^{1/2}
Feedback Resistor R _{F2}	v _{nRF2}	(4kTR _{F2}) ^{1/2}	1	v _{nO8} = (4kTR _{F2}) ^{1/2}

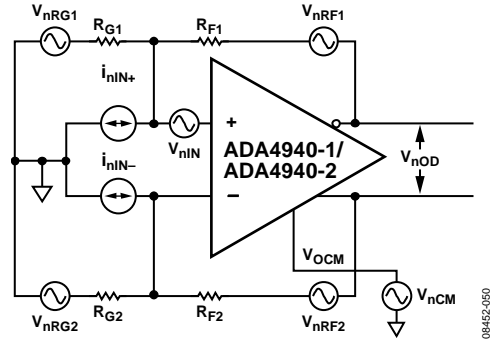

Figure 63. ADA4940-1/ADA4940-2 Noise Model

As with conventional op amp, the output noise voltage densities can be estimated by multiplying the input-referred terms at +IN and -IN by the appropriate output factor,

where:

$$G_N = \frac{2}{(\beta_1 + \beta_2)}$$

is the circuit noise gain.

$$\beta_1 = \frac{R_{G1}}{R_{F1} + R_{G1}} \text{ and } \beta_2 = \frac{R_{G2}}{R_{F2} + R_{G2}}$$

are the feedback factors.

When R_{F1}/R_{G1} = R_{F2}/R_{G2}, then β₁ = β₂ = β, and the noise gain becomes

$$G_N = \frac{1}{\beta} = 1 + \frac{R_F}{R_G}$$

Note that the output noise from V_{OCM} goes to zero in this case. The total differential output noise density, v_{nOD}, is the root-sum-square of the individual output noise terms.

$$v_{nOD} = \sqrt{\sum_{i=1}^8 v_{nOi}^2}$$

Table 15 and Table 16 list several common gain settings, recommended resistor values, input impedances, and output noise density for both balanced and unbalanced input configurations.

Table 15. Differential Ground-Referenced Input, DC-Coupled, $R_L = 1\text{ k}\Omega$ (See Figure 64)

Nominal Gain (dB)	R_F (Ω)	R_G (Ω)	$R_{IN, dm}$ (Ω)	Differential Output Noise Density (nV/ $\sqrt{\text{Hz}}$)	RTI (nV/ $\sqrt{\text{Hz}}$)
0	1000	1000	2000	11.3	11.3
6	1000	500	1000	15.4	7.7
10	1000	318	636	20.0	6.8
14	1000	196	392	27.7	5.5

Table 16. Single-Ended Ground-Referenced Input, DC-Coupled, $R_S = 50\ \Omega$, $R_L = 1\text{ k}\Omega$ (See Figure 65)

Nominal Gain (dB)	R_F (Ω)	R_G (Ω)	R_T (Ω)	$R_{IN, se}$ (Ω)	R_{G1} (Ω) ¹	Differential Output Noise Density (nV/ $\sqrt{\text{Hz}}$)	RTI (nV/ $\sqrt{\text{Hz}}$)
0	1000	1000	52.3	1333	1025	11.2	11.2
6	1000	500	53.6	750	526	15.0	7.5
10	1000	318	54.9	512	344	19.0	6.3
14	1000	196	59.0	337	223	25.3	5

¹ $R_{G1} = R_G + (R_S || R_T)$

IMPACT OF MISMATCHES IN THE FEEDBACK NETWORKS

Even if the external feedback networks (R_F/R_G) are mismatched, the internal common-mode feedback loop still forces the outputs to remain balanced. The amplitudes of the signals at each output remain equal and 180° out of phase. The input-to-output, differential mode gain varies proportionately to the feedback mismatch, but the output balance is unaffected.

As well as causing a noise contribution from V_{OCM} , ratio-matching errors in the external resistors result in a degradation of the ability of the circuit to reject input common-mode signals, much the same as for a four resistors difference amplifier made from a conventional op amp.

In addition, if the dc levels of the input and output common-mode voltages are different, matching errors result in a small differential mode, output offset voltage. When $G = 1$, with a ground-referenced input signal and the output common-mode level set to 2.5 V, an output offset of as much as 25 mV (1% of the difference in common-mode levels) can result if 1% tolerance resistors are used. Resistors of 1% tolerance result in a worst-case input CMRR of about 40 dB, a worst-case differential mode output offset of 25 mV due to the 2.5 V level-shift, and no significant degradation in output balance error.

CALCULATING THE INPUT IMPEDANCE OF AN APPLICATION CIRCUIT

The effective input impedance of a circuit depends on whether the amplifier is being driven by a single-ended or differential signal source. For balanced differential input signals, as shown in Figure 64, the input impedance ($R_{IN, dm}$) between the inputs ($+D_{IN}$ and $-D_{IN}$) is simply $R_{IN, dm} = 2 \times R_G$.

For an unbalanced, single-ended input signal (see Figure 65), the input impedance is

$$R_{IN, se} = \left(\frac{R_G}{1 - \frac{R_F}{2 \times (R_G + R_F)}} \right)$$

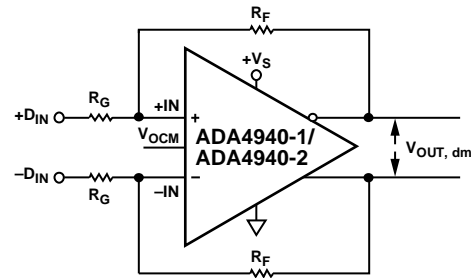

Figure 64. ADA4940-1/ADA4940-2 Configured for Balanced (Differential) Inputs

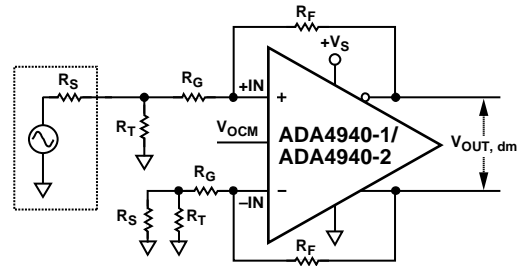

Figure 65. ADA4940-1/ADA4940-2 Configured for Unbalanced (Single-Ended) Input

The input impedance of the circuit is effectively higher than it would be for a conventional op amp connected as an inverter because a fraction of the differential output voltage appears at the inputs as a common-mode signal, partially bootstrapping the voltage across the input resistor R_{G1} .

Terminating a Single-Ended Input

This section describes how to properly terminate a single-ended input to the ADA4940-1/ADA4940-2 with a gain of 1, $R_F = 1\text{ k}\Omega$ and $R_G = 1\text{ k}\Omega$. An example using an input source with a terminated output voltage of 1 V p-p and source resistance of 50 Ω illustrates the three steps that must be followed. Because the terminated output voltage of the source is 1 V p-p, the open-circuit output voltage of the source is 2 V p-p. The source shown in Figure 66 indicates this open-circuit voltage.

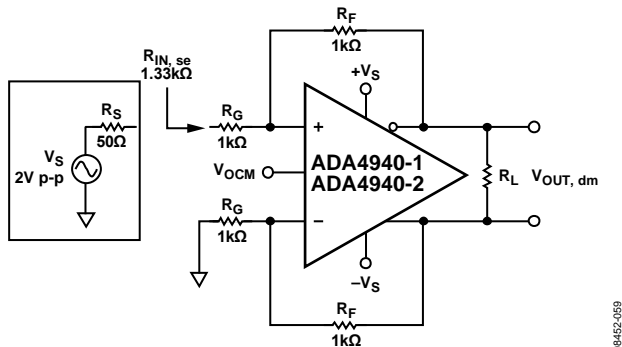

Figure 66. Calculating Single-Ended Input Impedance, R_{IN}

1. The input impedance is calculated by

$$R_{IN,se} = \left(\frac{R_G}{1 - \frac{R_G}{R_F}} \right) = \left(\frac{1000}{1 - \frac{1000}{1000}} \right) = 1.33\text{ k}\Omega$$

2. To match the 50 Ω source resistance, calculate the termination resistor, R_T , using $R_T || 1.33\text{ k}\Omega = 50\text{ }\Omega$. The closest standard 1% value for R_T is 52.3 Ω .

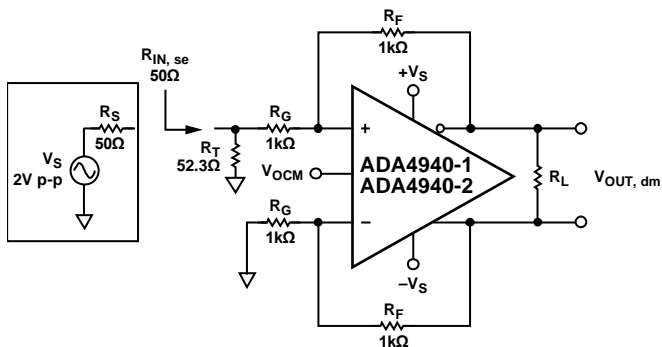

Figure 67. Adding Termination Resistor R_T

3. Figure 67 shows that the effective R_G in the upper feedback loop is now greater than the R_G in the lower loop due to the addition of the termination resistors. To compensate for the imbalance of the gain resistors, add a correction resistor (R_{TS}) in series with R_G in the lower loop. R_{TS} is the Thevenin equivalent of the source resistance, R_S , and the termination resistance, R_T , and is equal to $R_S || R_T$.

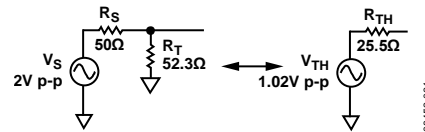

Figure 68. Calculating the Thevenin Equivalent

$R_{TS} = R_{TH} = R_S || R_T = 25.5\text{ }\Omega$. Note that V_{TH} is greater than 1 V p-p, which was obtained with $R_T = 50\text{ }\Omega$. The modified circuit with the Thevenin equivalent (closest 1% value used for R_{TH}) of the terminated source and R_{TS} in the lower feedback loop is shown in Figure 69.

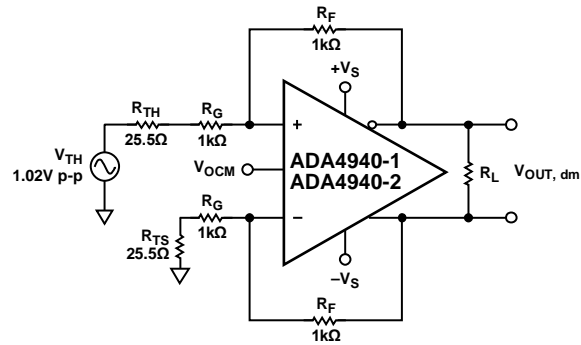

Figure 69. Thevenin Equivalent and Matched Gain Resistors

Figure 69 presents a tractable circuit with matched feedback loops that can be easily evaluated.

It is useful to point out two effects that occur with a terminated input. The first is that the value of R_G is increased in both loops, lowering the overall closed-loop gain. The second is that V_{TH} is a little larger than 1 V p-p, as it would be if $R_T = 50\text{ }\Omega$. These two effects have opposite impacts on the output voltage, and for large resistor values in the feedback loops ($\sim 1\text{ k}\Omega$), the effects essentially cancel each other out. For small R_F and R_G , or high gains, however, the diminished closed-loop gain is not cancelled completely by the increased V_{TH} . This can be seen by evaluating Figure 69.

The desired differential output in this example is 1 V p-p because the terminated input signal was 1 V p-p and the closed-loop gain = 1. The actual differential output voltage, however, is equal to $(1.02\text{ V p-p})(1000/1025.5) = 0.996\text{ V p-p}$. This is within the tolerance of the resistors, so no change to the feedback resistor, R_F , is required.

INPUT COMMON-MODE VOLTAGE RANGE

The ADA4940-1/ADA4940-2 input common-mode range is shifted down by approximately 1 V_{BE} , in contrast to other ADC drivers with centered input ranges, such as the ADA4939-x. The downward-shifted input common-mode range is especially suited to dc-coupled, single-ended-to-differential, and single-supply applications.

For $\pm 2.5\text{ V}$ or +5 V supply operation, the input common-mode range at the summing nodes of the amplifier is specified as -2.7 V to +1.3 V or -0.2 V to 3.8 V, and is specified as -0.2 V to +1.8 V with a +3 V supply.

INPUT AND OUTPUT CAPACITIVE AC COUPLING

Although the ADA4940-1/ADA4940-2 is best suited to dc-coupled applications, it is nonetheless possible to use it in ac-coupled circuits. Input ac coupling capacitors can be inserted between the source and R_G . This ac coupling blocks the flow of the dc common-mode feedback current and causes the ADA4940-1/ADA4940-2 dc input common-mode voltage to equal the dc output common-mode voltage. These ac coupling capacitors must be placed in both loops to keep the feedback factors matched. Output ac coupling capacitors can be placed in series between each output and its respective load.

SETTING THE OUTPUT COMMON-MODE VOLTAGE

The V_{OCM} pin of the ADA4940-1/ADA4940-2 is internally biased at a voltage approximately equal to the midsupply point, $[(+V_S) + (-V_S)]/2$. Relying on this internal bias results in an output common-mode voltage that is within approximately 100 mV of the expected value.

In cases where more accurate control of the output common-mode level is required, it is recommended that an external source, or resistor divider (10 kΩ or greater resistors), be used. The output common-mode offset listed in the Specifications section assumes that the V_{OCM} input is driven by a low impedance voltage source.

It is also possible to connect the V_{OCM} input to a common-mode level (CML) output of an ADC. However, care must be taken to ensure that the output has sufficient drive capability. The input impedance of the V_{OCM} pin is approximately 250 kΩ.

DISABLE PIN

The ADA4940-1/ADA4940-2 feature a DISABLE pin that can be used to minimize the quiescent current consumed when the device is not being used. DISABLE is asserted by applying a low logic level to the DISABLE pin. The threshold between high and low logic levels is nominally 1.4 V above the negative supply rail. See Table 5 and Table 8 for the threshold limits.

The DISABLE pin features an internal pull-up network that enables the amplifier for normal operation. The ADA4940-1/ADA4940-2 DISABLE pin can be left floating (that is, no external connection is required) and does not require an external pull-up resistor to ensure normal on operation (see Figure 70). When the ADA4940-1/ADA4940-2 is disabled, the output is high impedance. Note that the outputs are tied to the inputs through the feedback resistors and to the source using the gain resistors. In addition, there are back-to-back diodes on the input pins that limit the differential voltage to 1.2 V.

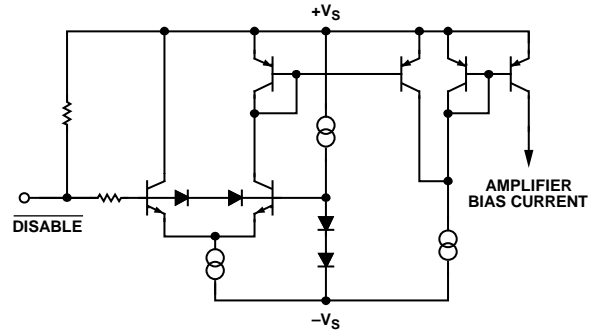

Figure 70. DISABLE Pin Circuit

DRIVING A CAPACITIVE LOAD

A purely capacitive load reacts with the bond wire and pin inductance of the ADA4940-1/ADA4940-2, resulting in high frequency ringing in the transient response and loss of phase margin. One way to minimize this effect is to place a resistor in series with each output to buffer the load capacitance. The resistor and load capacitance form a first-order, low-pass filter; therefore, the resistor value should be as small as possible. In some cases, the ADCs require small series resistors to be added on their inputs.

Figure 71 illustrates the capacitive load vs. the series resistance required to maintain a minimum 45° of phase margin.

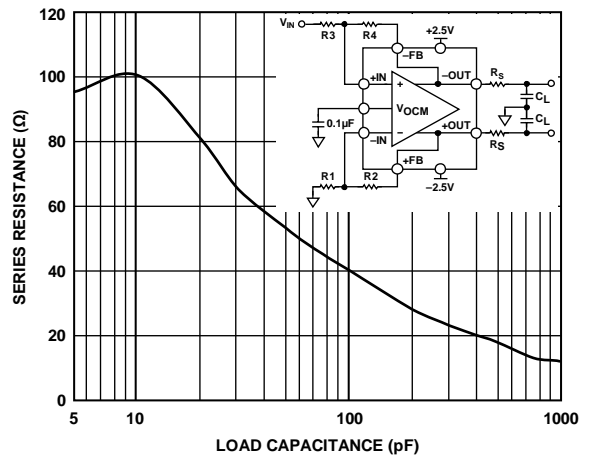

Figure 71. Capacitive Load vs. Series Resistance (LFSCP)

DRIVING A HIGH PRECISION ADC

The ADA4940-1/ADA4940-2 are ideally suited for broadband dc-coupled applications. The circuit in Figure 73 shows a front-end connection for an ADA4940-1 driving an AD7982, which is an 18-bit, 1 MSPS successive approximation, analog-to-digital converter (ADC) that operates from a single power supply, 3 V to 5 V. It contains a low power, high speed, 18-bit sampling ADC and a versatile serial interface port. The reference voltage, REF, is applied externally and can be set independent of the supply voltage. As shown in Figure 73, the ADA4940-1 is dc-coupled on the input and the output, which eliminates the need for a transformer to drive the ADC. The amplifier performs a single-ended-to-differential conversion if needed and level shifts the input signal to match the input common mode of the ADC. The ADA4940-1 is configured with a dual 7 V supply (+6 V and -1 V) and a gain that is set by the ratio of the feedback resistor to the gain resistor. In addition, the circuit can be used in a single-ended-input-to-differential output or differential-input-to-differential output configuration. If needed, a termination resistor in parallel with the source input can be used. Whether the input is a single-ended input or differential, the input impedance of the amplifier can be calculated as shown in the Terminating a Single-Ended Input section. If $R1 = R2 = R3 = R4 = 1\text{ k}\Omega$, the single-ended input impedance is approximately $1.33\text{ k}\Omega$, which, in parallel with a $52.3\ \Omega$ termination resistor, provides a $50\ \Omega$ termination for the source. An additional $25.5\ \Omega$ ($1025.5\ \Omega$ total) at the inverting input balances the parallel impedance of the $50\ \Omega$ source and the termination resistor driving the noninverting input. However, if a differential source input is used, the differential input impedance is $2\text{ k}\Omega$. In this case, two $52.3\ \Omega$ termination resistors are used to terminate the inputs.

In this example, the signal generator has a 10 V p-p symmetric, ground-referenced bipolar output. The V_{OCM} input is bypassed for noise reduction and set externally with 1% resistors to 2.5 V to maximize the output dynamic range. With an output common-

mode voltage of 2.5 V, each ADA4940-1 output swings between 0 V and 5 V, opposite in phase, providing a gain of 1 and a 10 V p-p differential signal to the ADC input. The differential RC section between the ADA4940-1 output and the ADC provides single-pole, low-pass filtering with a corner frequency of 1.79 MHz and extra buffering for the current spikes that are output from the ADC input when its sample-and-hold (SHA) capacitors are discharged.

The total system power in Figure 73 is under 35 mW. A large portion of that power is the current coming from supplies to the output, which is set at 2.5 V, going back to the input through the feedback and gain resistors. To reduce that power to 25 mW, increase the value of the feedback and gain resistor from $1\text{ k}\Omega$ to $2\text{ k}\Omega$ and set the value of the resistors R5 and R6 to $3\text{ k}\Omega$. The ADR435 is used to regulate the +6 V supply to +5 V, which ends up powering the ADC and setting the reference voltage for the V_{OCM} pin.

Figure 72 shows the fft of a 20 kHz differential input tone sampled at 1 MSPS. The second and third harmonics are down at -118 dBc and -122 dBc.

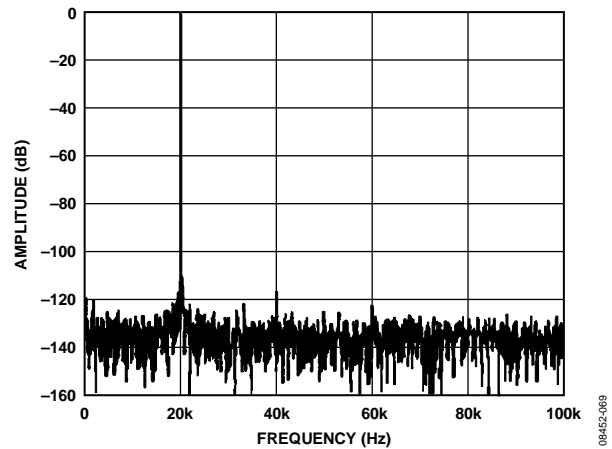

Figure 72. Distortion Measurement of a 20 kHz Input Tone (CN-0237)

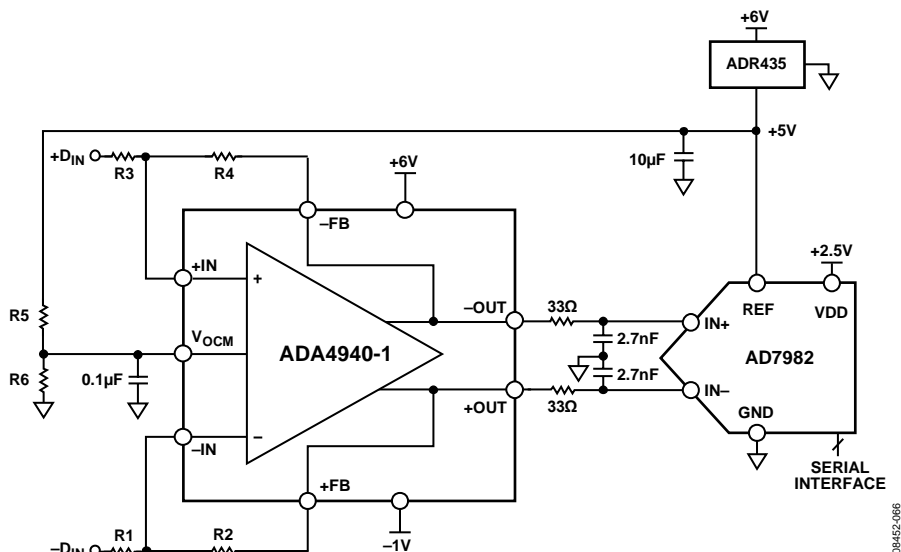

Figure 73. ADA4940-1 (LFCSP) Driving the AD7982 ADC

LAYOUT, GROUNDING, AND BYPASSING

As a high speed device, the ADA4940-1/ADA4940-2 are sensitive to the PCB environment in which they operate. Realizing their superior performance requires attention to the details of high speed PCB design.

ADA4940-1 LFCSP EXAMPLE

The first requirement is a solid ground plane that covers as much of the board area around the ADA4940-1 as possible. However, clear the area near the feedback resistors (R_F), gain resistors (R_G), and the input summing nodes (Pin 2 and Pin 3) of all ground and power planes (see Figure 74). Clearing the ground and power planes minimizes any stray capacitance at these nodes and prevents peaking of the response of the amplifier at high frequencies.

The thermal resistance, θ_{JA} , is specified for the device, including the exposed pad, soldered to a high thermal conductivity 4-layer circuit board, as described in EIA/JESD 51-7.

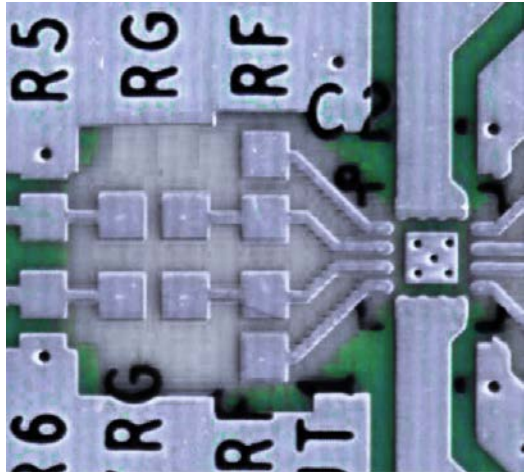

Figure 74. Ground and Power Plane Voiding in Vicinity of R_F and R_G

Bypass the power supply pins as close to the device as possible and directly to a nearby ground plane. Use high frequency ceramic chip capacitors. Use two parallel bypass capacitors (1000 pF and 0.1 μ F) for each supply. Place the 1000 pF capacitor closer to the device. Further away, provide low frequency bypassing using 10 μ F tantalum capacitors from each supply to ground.

Ensure that signal routing is short and direct to avoid parasitic effects. Wherever complementary signals exist, provide a symmetrical layout to maximize balanced performance. When routing differential signals over a long distance, ensure that PCB traces are close together, and twist any differential wiring such that loop area is minimized. Doing this reduces radiated energy and makes the circuit less susceptible to interference.

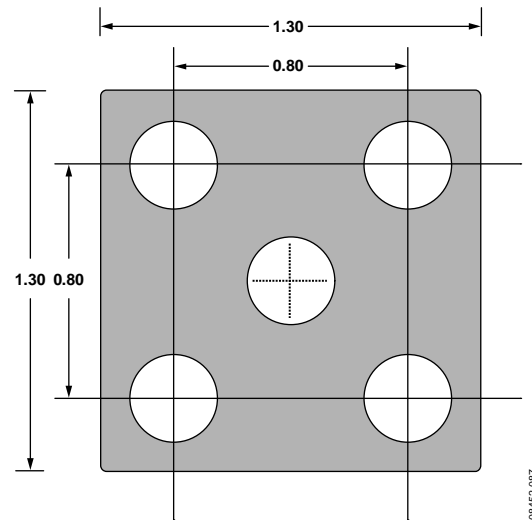

Figure 75. Recommended PCB Thermal Attach Pad Dimensions (mm)

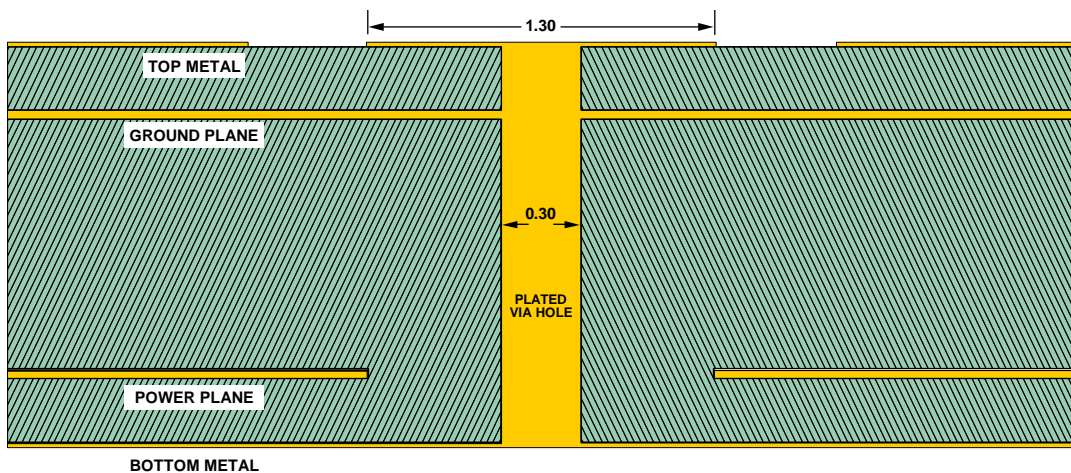
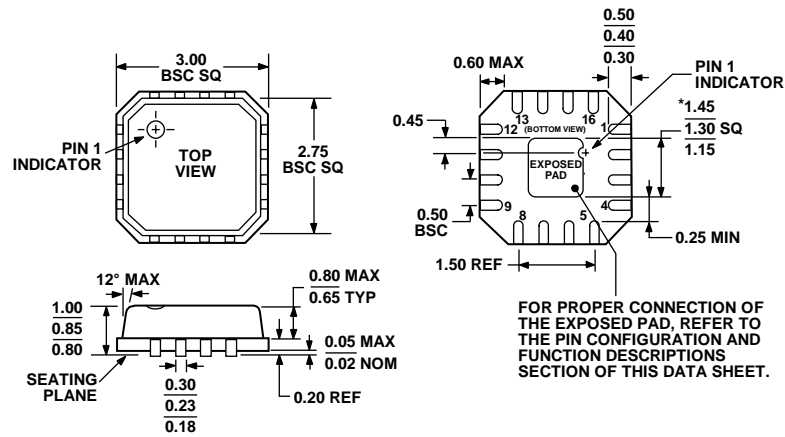

Figure 76. Cross-Section of 4-Layer PCB Showing Thermal Via Connection to Buried Ground Plane (Dimensions in mm)

OUTLINE DIMENSIONS



*COMPLIANT TO JEDEC STANDARDS MO-220-VEED-2 EXCEPT FOR EXPOSED PAD DIMENSION.

Figure 77. 16-Lead Lead Frame Chip Scale Package [LFCSP_VQ]
3 mm × 3 mm Body, Very Thin Quad
(CP-16-2)
Dimensions shown in millimeters

077208-A

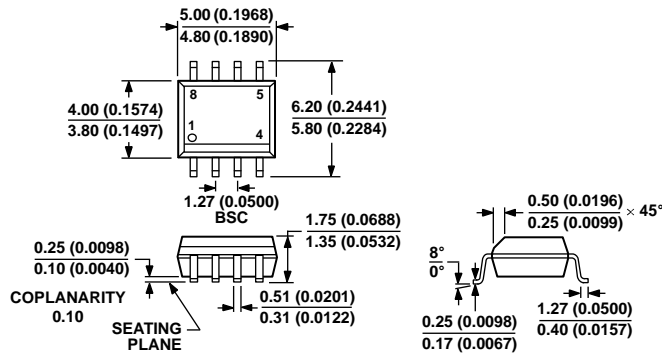

COMPLIANT TO JEDEC STANDARDS MS-012-AA
CONTROLLING DIMENSIONS ARE IN MILLIMETERS; INCH DIMENSIONS
(IN PARENTHESES) ARE ROUNDED-OFF MILLIMETER EQUIVALENTS FOR
REFERENCE ONLY AND ARE NOT APPROPRIATE FOR USE IN DESIGN.

Figure 78. 8-Lead Standard Small Outline Package [SOIC_N]
(R-8)
Dimensions shown in millimeters and (inches)

012407-A

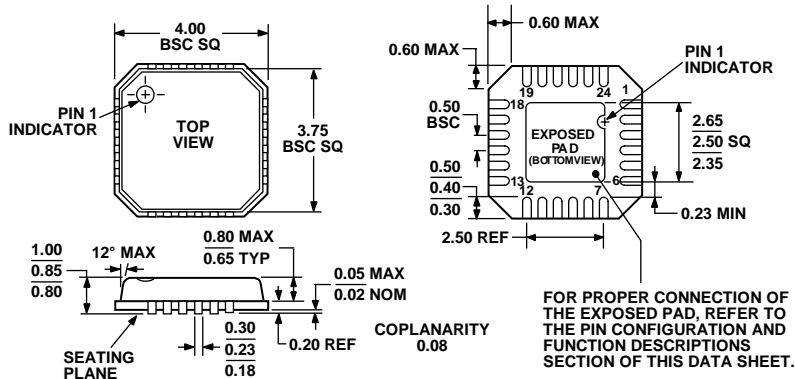

062508-A

Figure 79. 24-Lead Lead Frame Chip Scale Package [LFCSP_VQ]
 4 mm × 4 mm Body, Very Thin Quad
 (CP-24-3)
 Dimensions shown in millimeters

ORDERING GUIDE

Model ¹	Temperature Range	Package Description	Package Option	Ordering Quantity	Branding
ADA4940-1ACPZ-R2	-40°C to +125°C	16-Lead LFCSP_VQ	CP-16-2	250	H29
ADA4940-1ACPZ-RL	-40°C to +125°C	16-Lead LFCSP_VQ	CP-16-2	5,000	H29
ADA4940-1ACPZ-R7	-40°C to +125°C	16-Lead LFCSP_VQ	CP-16-2	1,500	H29
ADA4940-1ACP-EBZ		Evaluation Board			
ADA4940-1ARZ	-40°C to +125°C	8-Lead SOIC_N	R-8	98	
ADA4940-1ARZ-RL	-40°C to +125°C	8-Lead SOIC_N	R-8	2,500	
ADA4940-1ARZ-R7	-40°C to +125°C	8-Lead SOIC_N	R-8	1,000	
ADA4940-1AR-EBZ		Evaluation Board			
ADA4940-2ACPZ-R2	-40°C to +125°C	24-Lead LFCSP_VQ	CP-24-3	250	
ADA4940-2ACPZ-RL	-40°C to +125°C	24-Lead LFCSP_VQ	CP-24-3	5,000	
ADA4940-2ACPZ-R7	-40°C to +125°C	24-Lead LFCSP_VQ	CP-24-3	1,500	
ADA4940-2ACP-EBZ		Evaluation Board			

¹Z = RoHS Compliant Part.

NOTES

NOTES

NOTES

Компания «Life Electronics» занимается поставками электронных компонентов импортного и отечественного производства от производителей и со складов крупных дистрибьюторов Европы, Америки и Азии.

С конца 2013 года компания активно расширяет линейку поставок компонентов по направлению коаксиальный кабель, кварцевые генераторы и конденсаторы (керамические, пленочные, электролитические), за счёт заключения дистрибьюторских договоров

Мы предлагаем:

- Конкуренеспособные цены и скидки постоянным клиентам.
- Специальные условия для постоянных клиентов.
- Подбор аналогов.
- Поставку компонентов в любых объемах, удовлетворяющих вашим потребностям.
- Приемлемые сроки поставки, возможна ускоренная поставка.
- Доставку товара в любую точку России и стран СНГ.
- Комплексную поставку.
- Работу по проектам и поставку образцов.
- Формирование склада под заказчика.
- Сертификаты соответствия на поставляемую продукцию (по желанию клиента).
- Тестирование поставляемой продукции.
- Поставку компонентов, требующих военную и космическую приемку.
- Входной контроль качества.
- Наличие сертификата ISO.

В составе нашей компании организован Конструкторский отдел, призванный помогать разработчикам, и инженерам.

Конструкторский отдел помогает осуществить:

- Регистрацию проекта у производителя компонентов.
- Техническую поддержку проекта.
- Защиту от снятия компонента с производства.
- Оценку стоимости проекта по компонентам.
- Изготовление тестовой платы монтаж и пусконаладочные работы.



Тел: +7 (812) 336 43 04 (многоканальный)

Email: org@lifeelectronics.ru