

PRODUCT NO
10046972-001LF

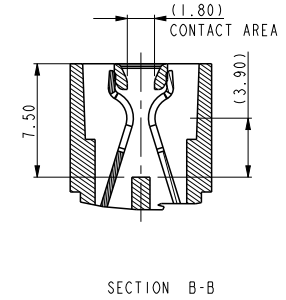
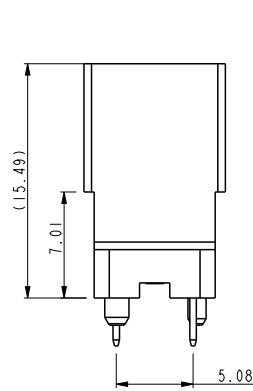
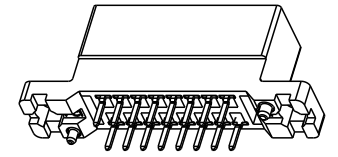
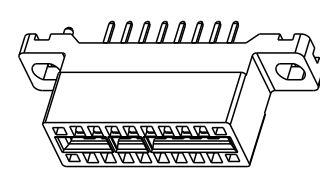
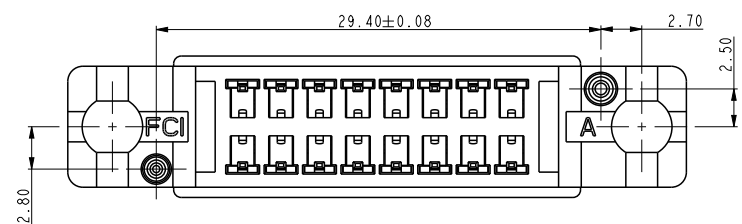
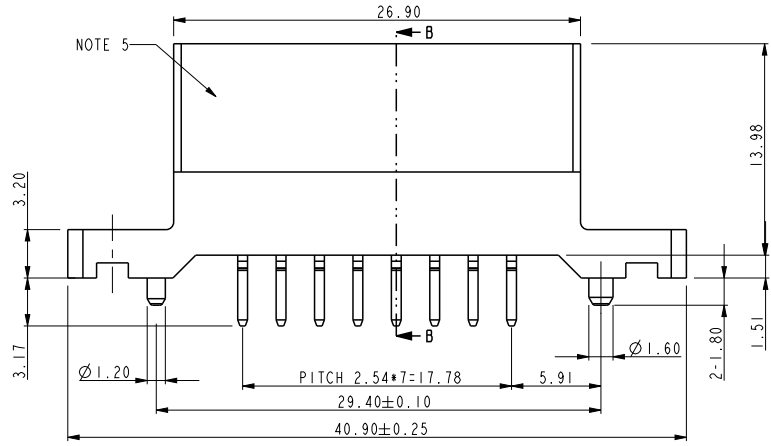
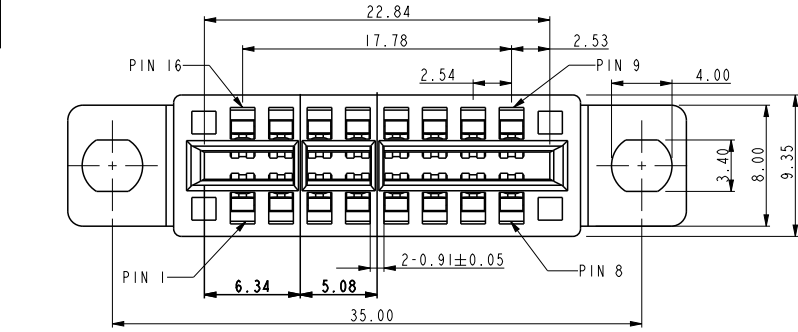

- NOTE:
- Material:
HOUSING: HIGH TEMPERATURE THERMOPLASTIC,
UL 94 V-0 FLAME RETARDANT.
TERMINAL: HIGH CONDUCTIVITY COPPER ALLOY.
PLATING SPEC AS BELOW:
Ni 50u" UNDER PLATED.
Au 30u" OVER CONTACT AREA. (ONE SIDE)
Matte Tin 120u" OVER SOLDERING AREA.
 - PACKING SPEC. GS-14-937.
 - PRODUCT SPEC. GS-12-338.
 - PART NUMBER 10046972-001LF MEETS EUROPEAN UNION DIRECTIVE AND OTHER COUNTRY REGULATIONS AS DESCRIBED IN GS-22-008.
THE HOUSING WILL WITHSTAND EXPOSURE TO 260°C PEAK TEMPERATURE FOR 10 SECONDS IN A WAVE SOLDER APPLICATION WITH A CIRCUIT BOARD.
 - PRODUCT MARKING ON HOUSING IN AREA SHOWN MEETS AFCI SPECIFICATION: GS-24-007.
 - A SYMBOL \triangle WILL BE NEXT TO ANY DIMENSION, VIEW, OR NOTE WHICH HAS BEEN MODIFIED WITH THE CURRENT DRAWING REVISION.

spec ref	*	dr	w wcadmin	2006/08/26	projection	MM	size	A4	scale	1.000
tolerance std	TOLERANCES UNLESS OTHERWISE SPECIFIED	eng	Sunny2 Liu	2016/05/05			← →	ecn no	ELX-DG-22934-1	
		chr	Terris Liu	2016/05/20					rel level	Released
surface	linear	appr	Pei-Ming Zheng	2016/05/24	product family					
	angular									
	0.X	±0.5	Amphenol FCI	title	PEC VT WITH MOUNTING EARS		dwg no	10046972		rev
	0.XX	±0.25								
	0.XXX	±0.13								
	0°	±°	cat. no.	*	Product - Customer Drw		sheet 1 of 4		G	

PRODUCT NO
10046972-001LF

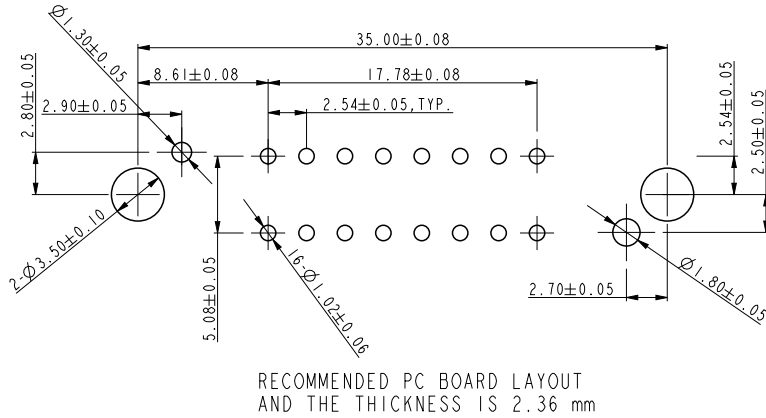
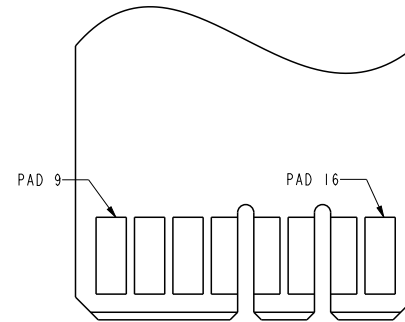
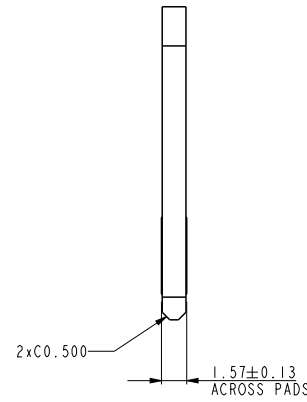
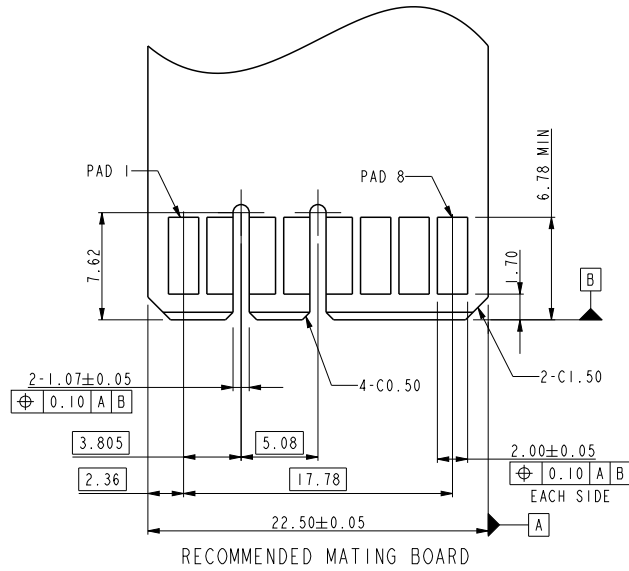

spec ref	*	dr	w wcadmin	2006/08/26	projection	MM ←→	size	A4	scale	1.000		
tolerance std	TOLERANCES UNLESS OTHERWISE SPECIFIED	eng	Sunny2 Liu	2016/05/05			ecn no	ELX-DG-22934-1				
		chr	Terris Liu	2016/05/20			product family	rel level	Released			
surface	linear	0.X	±0.5	Amphenol FCi	title		PEC VT WITH MOUNTING EARS		dwg no	10046972	rev	G
		0.XX	±0.25		2X8P		Product - Customer Drw					
		0.XXX	±0.13		cat. no.		sheet 2 of 4					
	angular	0°	±°									

A

B

C

D

PRODUCT NO
10046972-002LF

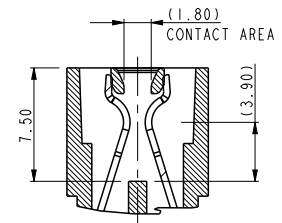
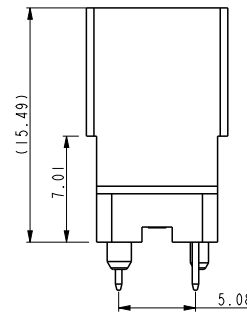
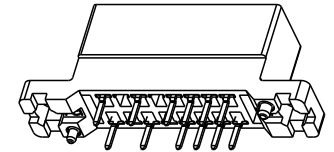
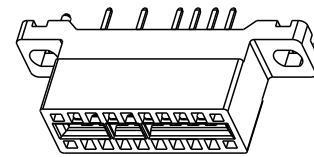
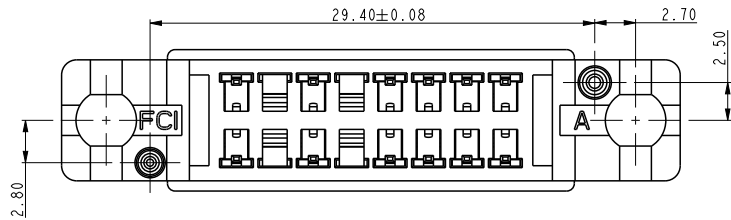
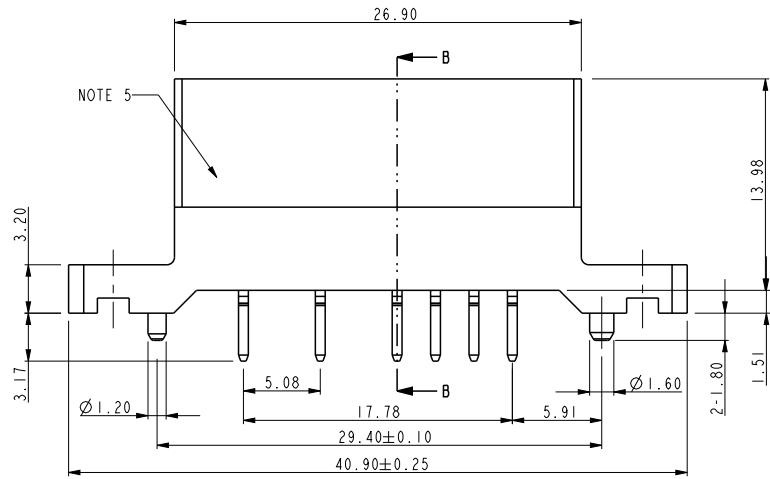
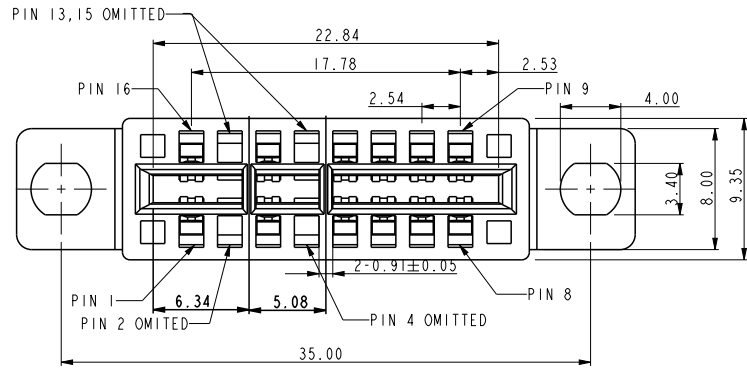

SECTION B-B

NOTE:

- Material:
HOUSING: HIGH TEMPERATURE THERMOPLASTIC,
UL 94 V-0 FLAME RETARDANT.
TERMINAL: HIGH CONDUCTIVITY COPPER ALLOY.
PLATING SPEC AS BELOW:
Ni 50u" UNDER PLATED.
Au 30u" OVER CONTACT AREA.(ONE SIDE)
Matte Tin 120u" OVER SOLDERING AREA.
- PACKING SPEC. GS-14-937.
- PRODUCT SPEC. GS-12-338.
- PART NUMBER 10046972-001LF MEETS EUROPEAN UNION DIRECTIVE AND OTHER COUNTRY REGULATIONS AS DESCRIBED IN GS-22-008.
THE HOUSING WILL WITHSTAND EXPOSURE TO 260°C PEAK TEMPERATURE FOR 10 SECONDS IN A WAVE SOLDER APPLICATION WITH A CIRCUIT BOARD.
PRODUCT MARKING ON HOUSING IN AREA SHOWN MEETS AFCI SPECIFICATION: GS-24-007.
- A SYMBOL WILL BE NEXT TO ANY DIMENSION, VIEW, OR NOTE WHICH HAS BEEN MODIFIED WITH THE CURRENT DRAWING REVISION.

spec ref	*	dr	w wcdadmin	2006/08/26	projection	MM	size	A4	scale	1.000
tolerance std	TOLERANCES UNLESS OTHERWISE SPECIFIED				eng	Sunny2 Liu	2016/05/05	ecn no	ELX-DG-22934-1	
		chr	Terris Liu	2016/05/20					rel level	Released
		appr	Pei-Ming Zheng	2016/05/24					product family	
surface	linear	0.X	±0.5		title PEC VT WITH MOUNTING EARS 2X8P		dwg no 10046972		rev G	
		0.XX	±0.25							
		0.XXX	±0.13							
	angular	0°	±°	cat. no.	*	Product - Customer Drw		sheet 3 of 4		

PRODUCT NO
10046972-002LF

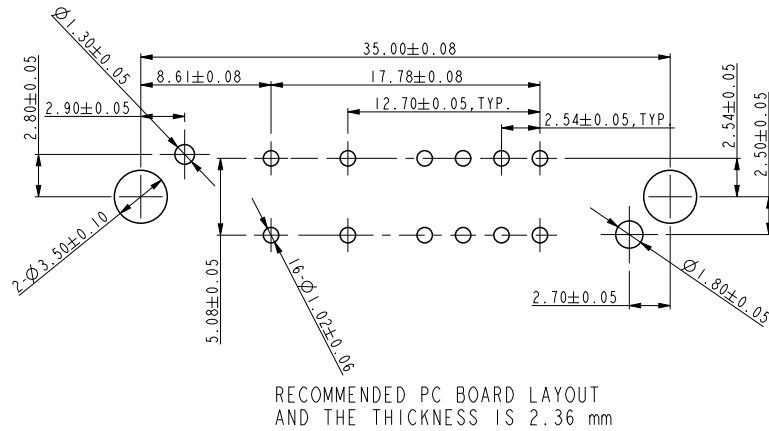
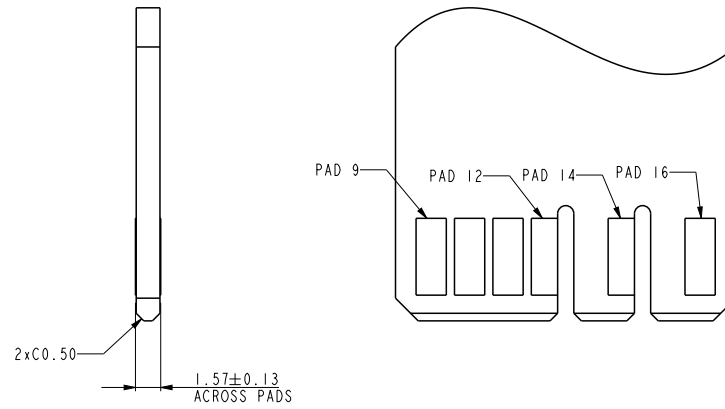
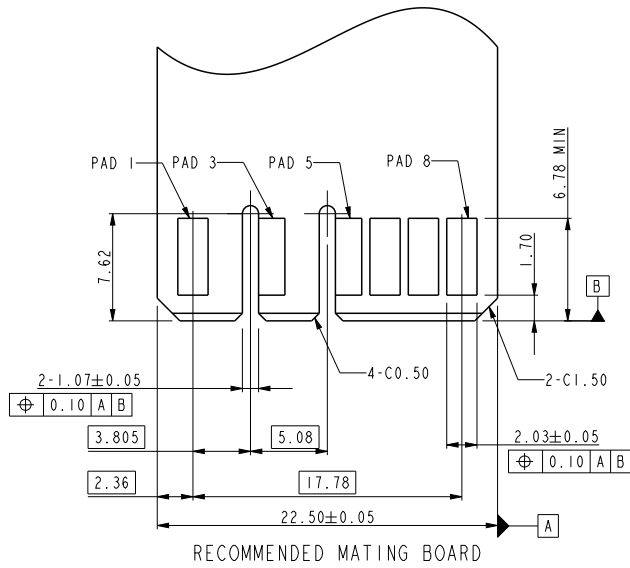

spec ref	*	dr	w wcadmin	2006/08/26	projection	MM	size	A4	scale	1.000	
tolerance std	TOLERANCES UNLESS OTHERWISE SPECIFIED	eng	Sunny2 Liu	2016/05/05			ecn no	ELX-DG-22934-1			
		chr	Terris Liu	2016/05/20			rel level	Released			
surface	linear	appr	Pei-Ming Zheng	2016/05/24	product family		rel level	Released			
	angular										
	0.X	±0.5	Amphenol FCI	title			dwg no	10046972			rev
	0.XX	±0.25		PEC VT WITH MOUNTING EARS				G			
	0.XXX	±0.13		2X8P							
	0°	±°	cat. no.	*	Product - Customer Drw			sheet 4 of 4			

Компания «Life Electronics» занимается поставками электронных компонентов импортного и отечественного производства от производителей и со складов крупных дистрибьюторов Европы, Америки и Азии.

С конца 2013 года компания активно расширяет линейку поставок компонентов по направлению коаксиальный кабель, кварцевые генераторы и конденсаторы (керамические, пленочные, электролитические), за счёт заключения дистрибьюторских договоров

Мы предлагаем:

- Конкурентоспособные цены и скидки постоянным клиентам.
- Специальные условия для постоянных клиентов.
- Подбор аналогов.
- Поставку компонентов в любых объемах, удовлетворяющих вашим потребностям.
- Приемлемые сроки поставки, возможна ускоренная поставка.
- Доставку товара в любую точку России и стран СНГ.
- Комплексную поставку.
- Работу по проектам и поставку образцов.
- Формирование склада под заказчика.
- Сертификаты соответствия на поставляемую продукцию (по желанию клиента).
- Тестирование поставляемой продукции.
- Поставку компонентов, требующих военную и космическую приемку.
- Входной контроль качества.
- Наличие сертификата ISO.

В составе нашей компании организован Конструкторский отдел, призванный помогать разработчикам, и инженерам.

Конструкторский отдел помогает осуществить:

- Регистрацию проекта у производителя компонентов.
- Техническую поддержку проекта.
- Защиту от снятия компонента с производства.
- Оценку стоимости проекта по компонентам.
- Изготовление тестовой платы монтаж и пусконаладочные работы.



Тел: +7 (812) 336 43 04 (многоканальный)

Email: org@lifeelectronics.ru