

DWG. NO.

SA94843

RBGT GROUNDING & RBMT MOUNTING TRACKS

THIS DRAWING IS A CONTROLLED DOCUMENT FOR SOURIAU USA, INC.
IT IS SUBJECT TO CHANGE WITHOUT NOTIFICATION.
CONTACT THE DOCUMENT CONTROL CENTER FOR THE LATEST REVISION.

PRO-E

THE INFORMATION CONTAINED IN THIS DRAWING IS CONFIDENTIAL AND MAY NOT BE
DISCLOSED WITHOUT WRITTEN CONSENT FROM SOURIAU USA, INC.

SUPERSEDES: SE94843-5

REV	DESCRIPTION	BY DATE	CHKD DATE
U	REVISED PER ECN 12047	RSK 10-09-13	SDH 10-09-13
T	REVISED PER ECN 11710	RSK 05-02-12	SDH 05-02-12
S	REVISED PER ECN 11271	VKP 11-15-10	SDH 11-15-10
R	REVISED PER ECN 7622	JRD 09-20-02	SDH 09-20-02

DRAWING TITLE

TRACKS, GROUNDING & MOUNTING

LINEAR MEASURE:  INCH [mm]

CAT NO. **RBGT _ & RBMT _ (SEE TABLE, SHT. 2)**

THIRD ANGLE PROJECTION

CAGE NO.: 09922

SIZE: A



APPROVAL

DRAWN:	VKP	11-15-10
CHKD :	SDH	11-15-10
DSGN :	JDA	10-13-92
MFG :	DH	11-15-10
QC :	DK	11-15-10

CUSTOMER

SOURIAU

DRAWING SCALE: 1:1
DRAWING NO. REV

TOLERANCES UNLESS OTHERWISE SPECIFIED

No. OF PLACES	INCH [mm]
ONE PLACE	±.1 [±3]
TWO PLACES	±.02 [±0.5]
THREE PLACES	±.010 [±0.25]

INTERPRET THIS DRAWING IN ACCORDANCE WITH ASME Y14.5M - 1994.

www.souriau.com

SA94843 U

1 OF 6

ANGLES ±1°

DWG. NO.
SA94843

NOTES:

- 1. GROUNDING TRACK ACCOMMODATES PIN CONTACTS PER MIL-C-39029/1-101. WITH A WIRE RANGE OF 24-22-20 AWG. USE INSERTION/REMOVAL TOOL PER MIL-I-81969/14C-11.

MATERIAL:

- STRAIN RELIEF GROMMET: SILICONE RUBBER, COLOR RED
- GROMMET BONDING: EPOXY
- GROUNDING MODULE BODY: GLASS FORTIFIED THERMOPLASTIC UL94V-0. COLOR BLUE
- GROUNDING AND MOUNTING TRACKS: 6063-T6 ALUMINUM
- GROUNDING RIVETS: ALUMINUM ALLOY
- GROUNDING SOCKET CONTACTS: BERYLLIUM COPPER
- CONTACT RETENTION CLIPS: BERYLLIUM COPPER
- SOCKET CONTACT SLEEVES: THERMOPLASTIC, LIQUID CRYSTAL POLYMER
- TERMINAL IDENTIFICATION STRIP: THERMOPLASTIC, UL94V-0, COLOR WHITE
- PROTECTIVE COATING: POLYURETHANE, COLOR OPTIONAL

FINISH:

- GROUNDING AND MOUNTING TRACKS: CHROMATE CONVERSION COATING PER MIL-C-81706, CLASS 3, METHOD C, COLOR GOLD. (REF: ALODINE 1200)
- GROUNDING SOCKET CONTACTS: 50 MICROINCHES [1.27 MICRONS] MIN. NICKEL ALL OVER. PIN CONTACT CURRENT BEARING SURFACE OVER-PLATED WITH 50 MICROINCHES [1.27 MICRONS] MIN. HARD GOLD.

DESCRIPTION TABLE		
SOURIAU CATALOG NO.	(O.A LENGTH)	WEIGHT (g)
RBGT2	2.000 [50.80]	17.5
RBGT4	4.000 [101.60]	35.0
RBGT6	6.000 [152.40]	52.5
RBGT8	8.000 [203.20]	70.0
RBGT10	10.000 [254.00]	87.5
RBGT14	14.000 [355.60]	122.5
RBGT16	16.000 [406.40]	140.0
RBGT18	18.000 [457.20]	157.5
RBGT20	20.000 [508]	175.0
RBGT22	22.000 [558.80]	192.5
RBGT26	26.000 [660.40]	227.5
RBGT28	28.000 [711.20]	245.0
RBGT34	34.000 [863.60]	297.5
RBGT38	38.000 [965.20]	332.5
RBMT2	2.000 [50.80]	6.25
RBMT4	4.000 [101.60]	12.5
RBMT6	6.000 [152.40]	18.75
RBMT8	8.000 [203.20]	25.0
RBMT10	10.000 [254.00]	31.25
RBMT14	14.000 [355.60]	43.75
RBMT16	16.000 [406.40]	50.0
RBMT18	18.000 [457.20]	56.25
RBMT20	20.000 [508]	62.5
RBMT22	22.000 [558.80]	68.75
RBMT26	26.000 [660.40]	81.25
RBMT28	28.000 [711.20]	87.5
RBMT34	34.000 [863.60]	106.25
RBMT38	38.000 [965.20]	118.75

---	ALL REV. RECORDED ON SHT. 1	---	---
REV		BY DATE	CHKD DATE

DRAWING TITLE		DRAWN: VKP 11-15-10	
TRACKS, GROUNDING & MOUNTING		CHKD : SDH 11-15-10	
RBGT _ & RBMT _ (SEE TABLE, SHT. 2)		DSGN : JDA 10-13-92	
CAT NO.	SIZE: A	MFG : DH 11-15-10	
CAGE NO.: 09922	SOURIAU	QC : DK 11-15-10	
		DRAWING SCALE: 1:1	
<p>CUSTOMER</p> <p>INTERPRET THIS DRAWING IN ACCORDANCE WITH ASME Y14.5M - 1994.</p>	www.souriau.com	DRAWING NO. REV	
		SA94843 U	
		2 OF 6	

LINEAR MEASURE: INCH [mm]

THIRD ANGLE PROJECTION

TOLERANCES UNLESS OTHERWISE SPECIFIED

No. OF PLACES	INCH [mm]
ONE PLACE	±.1 [±3]
TWO PLACES	±.02 [±0.5]
THREE PLACES	±.010 [±0.25]
ANGLES ±1°	

THIS DRAWING IS A CONTROLLED DOCUMENT FOR SOURIAU USA, INC. IT IS SUBJECT TO CHANGE WITHOUT NOTIFICATION. CONTACT THE DOCUMENT CONTROL CENTER FOR THE LATEST REVISION.

PRO-E

THE INFORMATION CONTAINED IN THIS DRAWING IS CONFIDENTIAL AND MAY NOT BE DISCLOSED WITHOUT WRITTEN CONSENT FROM SOURIAU USA, INC.

DWG. NO.
SA94843

PERFORMANCE CHARACTERISTICS

ELECTRICAL:

CONTACT RESISTANCE: IN ACCORDANCE WITH MIL-T-81714, PARA. 4.6.16.
REF: MIL-STD-1344, METHOD 3004.
SIZE 16-20: 45 MILLIVOLTS MAX. AT 7.5A WITH
20 AWG SILVER PLATED WIRE.

LOW LEVEL CONTACT RESISTANCE: IN ACCORDANCE WITH MIL-T-81714, PARA. 4.6.17.
REF: MIL-STD-1344, METHOD 3002.
SIZE 16-20: .009 OHMS MAX. WITH
20 AWG SILVER PLATED WIRE.

VOLTAGE STABILITY: 4 MILLIVOLT MAX. DIFFERENCE BETWEEN RECORDED HIGHEST
AND LOWEST POTENTIAL DROP VALUES IN ACCORDANCE WITH
MIL-T-81714, PARA. 4.6.18.

ENVIRONMENTAL:

FLUID IMMERSION: ALL MATERIALS ARE RESISTANT TO BMS3-11 (SKYDROL LD-4) AND
MIL-H-5606 HYDRAULIC FLUIDS, AND MIL-L-7808 AND
MIL-L-23699 LUBRICATING OILS.

HUMIDITY: IN ACCORDANCE WITH MIL-T-81714, PARA. 4.6.10.
REF: MIL-STD-1344, METHOD 1002, TYPE II, (EXCEPT WITHOUT
STEP 7b)

SALT SPRAY: 500 HOURS IN ACCORDANCE WITH MIL-T-81714, PARA. 4.6.12.
REF: MIL-STD-1344, METHOD 1001, TEST CONDITION C.

VIBRATION (SINUSOIDAL): IN ACCORDANCE WITH MIL-T-81714, PARA. 4.6.8.1.
REF: MIL-STD-202, METHOD 204, TEST CONDITION G.

VIBRATION (RANDOM): IN ACCORDANCE WITH MIL-T-81714, PARA. 4.6.8.2.
REF: MIL-STD-1344, METHOD 2005, TEST CONDITION VI, LETTER J.

MECHANICAL (IMPACT) SHOCK: IN ACCORDANCE WITH MIL-T-81714, PARA. 4.6.9.
REF: MIL-STD-1344, METHOD 2004, TEST CONDITION D.

THERMAL SHOCK: IN ACCORDANCE WITH MIL-T-81714, PARA. 4.6.5.
REF: MIL-STD-1344, METHOD 1003, TEST CONDITION A,
(EXCEPT TEMPERATURE EXTREMES ARE -65°C TO +150°C
[-85°F TO +302°F]).

TEMPERATURE LIFE: 150°C [302°F] FOR 1000 HOURS IN ACCORDANCE WITH
MIL-T-81714, PARA. 4.6.13.

OZONE: IN ACCORDANCE WITH MIL-T-81714, PARA. 4.6.14.
REF: MIL-STD-1344, METHOD 1007.

---	ALL REV. RECORDED ON SHT. 1	---	---
REV	DESCRIPTION	BY DATE	CHKD DATE

DRAWING TITLE
TRACKS, GROUNDING & MOUNTING

CAT NO. **RBGT _ & RBMT _ (SEE TABLE, SHT. 2)**

CAGE NO.: 09922 SIZE: A

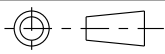
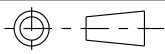
<p>LINEAR MEASURE:  INCH [mm]</p> <p>THIRD ANGLE PROJECTION </p> <p>TOLERANCES UNLESS OTHERWISE SPECIFIED</p> <table border="1"> <tr> <th>No. OF PLACES</th> <th>INCH [mm]</th> </tr> <tr> <td>ONE PLACE</td> <td>±.1 [±3]</td> </tr> <tr> <td>TWO PLACES</td> <td>±.02 [±0.5]</td> </tr> <tr> <td>THREE PLACES</td> <td>±.010 [±0.25]</td> </tr> <tr> <td colspan="2">ANGLES ±1°</td> </tr> </table>	No. OF PLACES	INCH [mm]	ONE PLACE	±.1 [±3]	TWO PLACES	±.02 [±0.5]	THREE PLACES	±.010 [±0.25]	ANGLES ±1°		<p>CUSTOMER</p> <p>SOURIAU</p> <p>www.souriau.com</p>	<p>APPROVAL</p> <table border="1"> <tr> <td>DRAWN: VKP</td> <td>11-15-10</td> </tr> <tr> <td>CHKD : SDH</td> <td>11-15-10</td> </tr> <tr> <td>DSGN : JDA</td> <td>10-13-92</td> </tr> <tr> <td>MFG : DH</td> <td>11-15-10</td> </tr> <tr> <td>QC : DK</td> <td>11-15-10</td> </tr> </table> <p>DRAWING SCALE: 1:1</p> <table border="1"> <tr> <td>DRAWING NO.</td> <td>REV</td> </tr> <tr> <td>SA94843</td> <td>U</td> </tr> </table> <p>3 OF 6</p>	DRAWN: VKP	11-15-10	CHKD : SDH	11-15-10	DSGN : JDA	10-13-92	MFG : DH	11-15-10	QC : DK	11-15-10	DRAWING NO.	REV	SA94843	U
	No. OF PLACES	INCH [mm]																								
	ONE PLACE	±.1 [±3]																								
	TWO PLACES	±.02 [±0.5]																								
	THREE PLACES	±.010 [±0.25]																								
ANGLES ±1°																										
DRAWN: VKP	11-15-10																									
CHKD : SDH	11-15-10																									
DSGN : JDA	10-13-92																									
MFG : DH	11-15-10																									
QC : DK	11-15-10																									
DRAWING NO.	REV																									
SA94843	U																									
<p>INTERPRET THIS DRAWING IN ACCORDANCE WITH ASME Y14.5M - 1994.</p>																										

THIS DRAWING IS A CONTROLLED DOCUMENT FOR SOURIAU USA, INC. IT IS SUBJECT TO CHANGE WITHOUT NOTIFICATION. CONTACT THE DOCUMENT CONTROL CENTER FOR THE LATEST REVISION.

PRO-E

THE INFORMATION CONTAINED IN THIS DRAWING IS CONFIDENTIAL AND MAY NOT BE DISCLOSED WITHOUT WRITTEN CONSENT FROM SOURIAU USA, INC.

DWG. NO.

SA94843

PERFORMANCE CHARACTERISTICS

MECHANICAL:

MAGNETIC PERMEABILITY: ALL MATERIALS DO NOT EXHIBIT A RELATIVE MAGNETIC PERMEABILITY OF GREATER THAN 2 IN ACCORDANCE WITH MIL-T-81714, PARA. 4.6.15. REF: MIL-STD-1344, METHOD 3006.

MAINTENANCE AGING: IN ACCORDANCE WITH MIL-T-81714, PARA. 4.6.3.

CONTACT INSERTION/REMOVAL FORCE: 10 LBS [44,4N] MAX. IN ACCORDANCE WITH MIL-T-81714, PARA.4.6.3

CONTACT RETENTION: 20 LBS [88,9N] MIN. IN ACCORDANCE WITH MIL-T-81714, PARA. 4.6.4. AXIAL DISPLACEMENT DOES NOT EXCEED .012 [0,30]. REF: MIL-STD-1344, METHOD 2007.

PROBE DAMAGE: IN ACCORDANCE WITH MIL-T-81714, PARA. 4.6.2.

RETENTION SYSTEM FLUID IMMERSION: IN ACCORDANCE WITH MIL-T-81714, PARA. 4.6.23.

INTERNAL CONTACT DURABILITY: 100 CYCLES OF MATING AND UNMATING TO DEPTH OF MECHANICAL AND ELECTRICAL ENGAGEMENT IN ACCORDANCE WITH MIL-T-81714, PARA. 4.6.19.

OVERSIZE PIN CONTACT PROTECTION: GROUNDING MODULE DESIGNED TO PREVENT ENTRANCE OF AN OVERSIZE TEST PIN OF Ø.070 [1,78] IN ACCORDANCE WITH MIL-T-81714, PARA. 4.6.20.

CONTACT WALKOUT: IN ACCORDANCE WITH MIL-T-81714, PARA. 4.6.22. REF: MIL-STD-1549.

SEE DRAWING SE94834 FOR
FEEDBACK MODULE

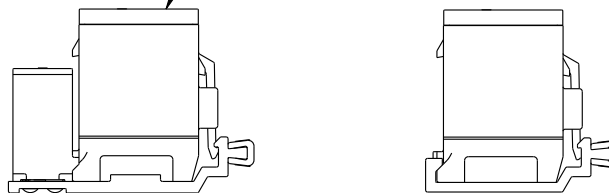

FEEDBACK MODULE INSTALLED IN
GROUNDING AND MOUNTING TRACKS
SCALE 1:1

---	ALL REV. RECORDED ON SHT. 1	---	---
REV	DESCRIPTION	BY DATE	CHKD DATE

DRAWING TITLE
TRACKS, GROUNDING & MOUNTING

CAT NO. **RBGT _ & RBMT _ (SEE TABLE, SHT. 2)**

LINEAR MEASURE: INCH [mm]

THIRD ANGLE PROJECTION

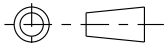

TOLERANCES UNLESS OTHERWISE SPECIFIED

No. OF PLACES	INCH [mm]
ONE PLACE	±.1 [±3]
TWO PLACES	±.02 [±0.5]
THREE PLACES	±.010 [±0.25]
ANGLES ±1°	

CAGE NO.: 09922

CUSTOMER

INTERPRET THIS DRAWING IN ACCORDANCE WITH ASME Y14.5M - 1994.

SIZE: A

SOURIAU

www.souriau.com

APPROVAL	DRAWN: VKP	11-15-10
	CHKD : SDH	11-15-10
	DSGN : JDA	10-13-92
	MFG : DH	11-15-10
	QC : DK	11-15-10
DRAWING SCALE: 1:1		
DRAWING NO.		REV
SA94843		U
4 OF 6		

THIS DRAWING IS A CONTROLLED DOCUMENT FOR SOURIAU USA, INC. IT IS SUBJECT TO CHANGE WITHOUT NOTIFICATION. CONTACT THE DOCUMENT CONTROL CENTER FOR THE LATEST REVISION.

PRO-E

THE INFORMATION CONTAINED IN THIS DRAWING IS CONFIDENTIAL AND MAY NOT BE DISCLOSED WITHOUT WRITTEN CONSENT FROM SOURIAU USA, INC.

DWG. NO.
SA94843

THIS DRAWING IS A CONTROLLED DOCUMENT FOR SOURIAU USA, INC. IT IS SUBJECT TO CHANGE WITHOUT NOTIFICATION. CONTACT THE DOCUMENT CONTROL CENTER FOR THE LATEST REVISION.

PRO-E

THE INFORMATION CONTAINED IN THIS DRAWING IS CONFIDENTIAL AND MAY NOT BE DISCLOSED WITHOUT WRITTEN CONSENT FROM SOURIAU USA, INC.

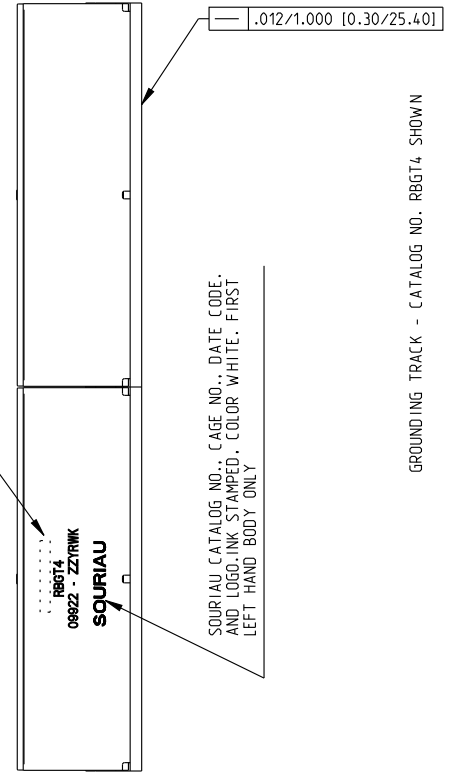
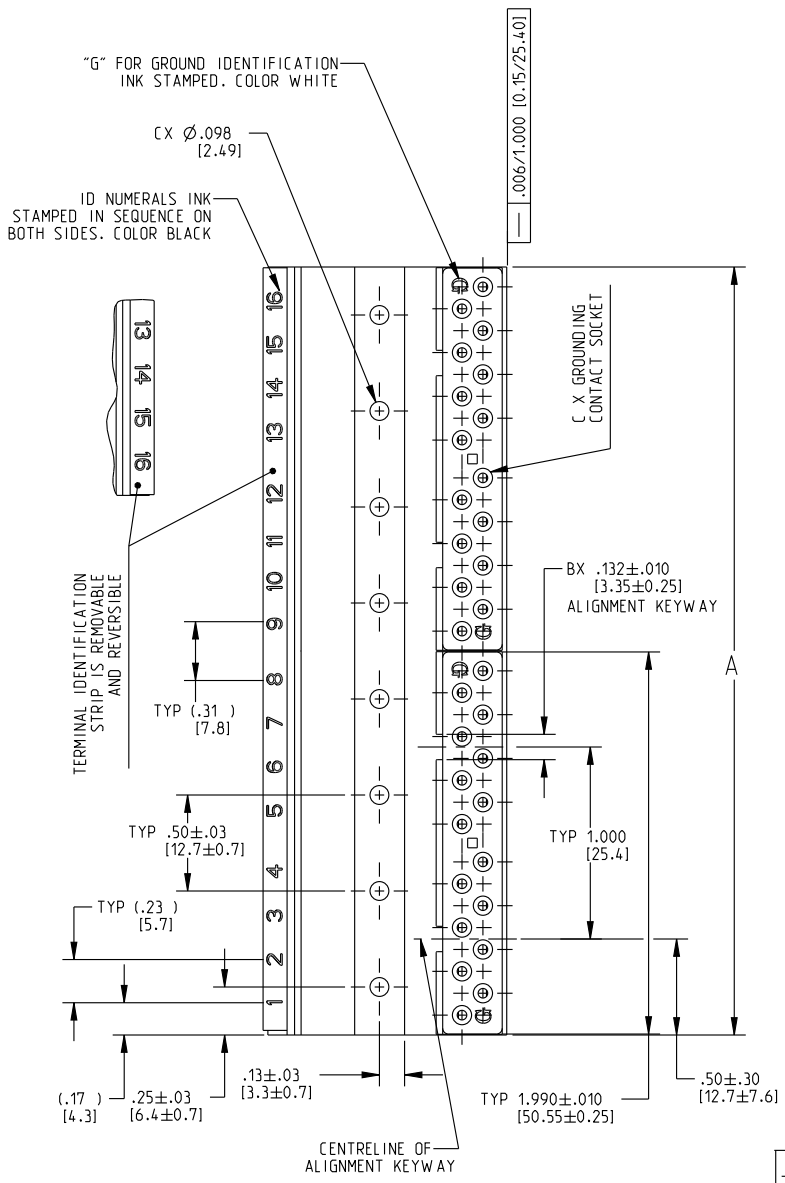
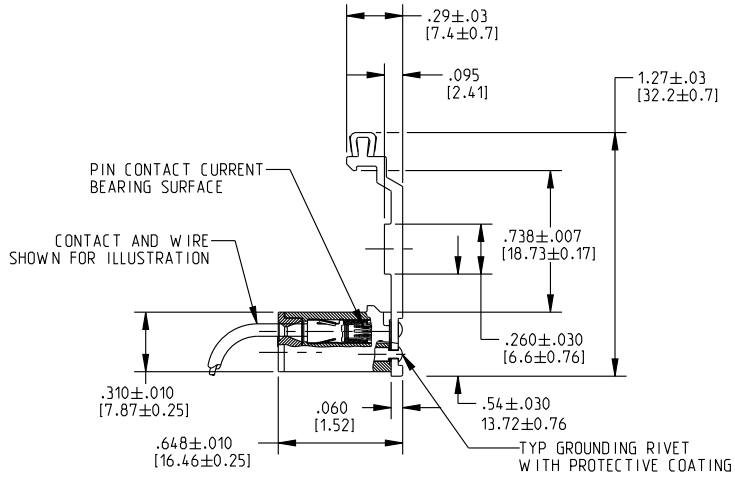

GROUNDING TRACK - CATALOG NO. RBGT4 SHOWN

---	ALL REV. RECORDED ON SHT. 1	---	---
REV	DESCRIPTION	BY DATE	CHKD DATE

DRAWING TITLE
TRACKS, GROUNDING & MOUNTING

LINEAR MEASURE:		INCH [mm]
THIRD ANGLE PROJECTION		
TOLERANCES UNLESS OTHERWISE SPECIFIED		
No. OF PLACES	INCH [mm]	
ONE PLACE	±.1 [±3]	
TWO PLACES	±.02 [±0.5]	
THREE PLACES	±.010 [±0.25]	
ANGLES ±1°		

CAT NO.	RBGT & RBMT (SEE TABLE, SHT. 2)
CAGE NO.:	09922
SIZE:	A
CUSTOMER	
INTERPRET THIS DRAWING IN ACCORDANCE WITH ASME Y14.5M - 1994.	

APPROVAL	DRAWN:	VKP	11-15-10
	CHKD :	SDH	11-15-10
	DSGN :	JDA	10-13-92
	MFG :	DH	11-15-10
	QC :	DK	11-15-10
	DRAWING SCALE:		1:1
DRAWING NO.		SA94843	REV
		U	
		5 OF 6	

SOURIAU
www.souriau.com

THIS DRAWING IS A CONTROLLED DOCUMENT FOR SOURIAU USA, INC. IT IS SUBJECT TO CHANGE WITHOUT NOTIFICATION. CONTACT THE DOCUMENT CONTROL CENTER FOR THE LATEST REVISION.

PRO-E

THIS DRAWING IS CONFIDENTIAL AND MAY NOT BE DISCLOSED WITHOUT WRITTEN CONSENT FROM SOURIAU USA, INC.

DWG. NO.

SA94843



MOUNTING TRACK - CATALOG NO. RBMT4 SHOWN

DIMENSIONS, INK STAMPING, AND OTHER FEATURES ARE THE SAME AS THE GROUNDING TRACK EXCEPT AS SHOWN.

SOURIAU CATALOG NO.	BOEING PART NO.	MOUNTING TRACK			FEEDBACK MODULES ACCOMMODATED SEE DWG. SE94834
		SOURIAU CATALOG NO.	BOEING PART NO.	A ±.010 [0.25]	
RBGT2	S280W 555-502	RBMT2	S280W 555-602	2.000 [50.80]	2
RBGT4	S280W 555-504	RBMT4	S280W 555-604	4.000 [101.60]	4
RBGT6	S280W 555-506	RBMT6	S280W 555-606	6.000 [152.40]	6
RBGT8	S280W 555-508	RBMT8	S280W 555-608	8.000 [203.20]	8
RBGT10	S280W 555-510	RBMT10	S280W 555-610	10.000 [254.00]	10
RBGT14	S280W 555-514	RBMT14	S280W 555-614	14.000 [355.60]	14
RBGT16	S280W 555-516	RBMT16	S280W 555-616	16.000 [406.40]	16
RBGT18	S280W 555-518	RBMT18	S280W 555-618	18.000 [457.20]	18
RBGT20	S280W 555-520	RBMT20	S280W 555-620	20.000 [508]	20
RBGT22	S280W 555-522	RBMT22	S280W 555-622	22.000 [558.80]	22
RBGT26	S280W 555-526	RBMT26	S280W 555-626	26.000 [660.40]	26
RBGT28	S280W 555-528	RBMT28	S280W 555-628	28.000 [711.20]	28
RBGT34	S280W 555-534	RBMT34	S280W 555-634	34.000 [863.60]	34
RBGT38	S280W 555-538	RBMT38	S280W 555-638	38.000 [965.20]	38

---	ALL REV. RECORDED ON SHT. 1	---	---
REV	ECN NUMBER	BY DATE	CHKD DATE

DRAWING TITLE
TRACKS, GROUNDING & MOUNTING

CAT NO. **RBGT _ & RBMT _ (SEE TABLE, SHT. 2)**

CAGE NO.: 09922 SIZE: A

<p>CUSTOMER</p> <p>INTERPRET THIS DRAWING IN ACCORDANCE WITH ASME Y14.5M - 1994.</p>	<p>SOURIAU</p> <p>www.souriau.com</p>	<p>APPROVAL</p> <p>DRAWN: VKP 11-15-10</p> <p>CHKD : SDH 11-15-10</p> <p>DSGN : JDA 10-13-92</p> <p>MFG : DH 11-15-10</p> <p>QC : DK 11-15-10</p>
		<p>DRAWING SCALE: 1:1</p>
		<p>DRAWING NO. SA94843</p>
		<p>REV U</p>

LINEAR MEASURE:	INCH [mm]
THIRD ANGLE PROJECTION	
TOLERANCES UNLESS OTHERWISE SPECIFIED	
No. OF PLACES	INCH [mm]
ONE PLACE	±.1 [±3]
TWO PLACES	±.02 [±0.5]
THREE PLACES	±.010 [±0.25]
ANGLES ±1°	

Компания «Life Electronics» занимается поставками электронных компонентов импортного и отечественного производства от производителей и со складов крупных дистрибьюторов Европы, Америки и Азии.

С конца 2013 года компания активно расширяет линейку поставок компонентов по направлению коаксиальный кабель, кварцевые генераторы и конденсаторы (керамические, пленочные, электролитические), за счёт заключения дистрибьюторских договоров

Мы предлагаем:

- Конкурентоспособные цены и скидки постоянным клиентам.
- Специальные условия для постоянных клиентов.
- Подбор аналогов.
- Поставку компонентов в любых объемах, удовлетворяющих вашим потребностям.
- Приемлемые сроки поставки, возможна ускоренная поставка.
- Доставку товара в любую точку России и стран СНГ.
- Комплексную поставку.
- Работу по проектам и поставку образцов.
- Формирование склада под заказчика.
- Сертификаты соответствия на поставляемую продукцию (по желанию клиента).
- Тестирование поставляемой продукции.
- Поставку компонентов, требующих военную и космическую приемку.
- Входной контроль качества.
- Наличие сертификата ISO.

В составе нашей компании организован Конструкторский отдел, призванный помогать разработчикам, и инженерам.

Конструкторский отдел помогает осуществить:

- Регистрацию проекта у производителя компонентов.
- Техническую поддержку проекта.
- Защиту от снятия компонента с производства.
- Оценку стоимости проекта по компонентам.
- Изготовление тестовой платы монтаж и пусконаладочные работы.



Тел: +7 (812) 336 43 04 (многоканальный)

Email: org@lifeelectronics.ru