

# MMBT4401L, SMMBT4401L

## Switching Transistor

### NPN Silicon

#### Features

- These Devices are Pb-Free, Halogen Free/BFR Free and are RoHS Compliant
- AEC-Q101 Qualified and PPAP Capable
- S Prefix for Automotive and Other Applications Requiring Unique Site and Control Change Requirements

#### MAXIMUM RATINGS

Rating	Symbol	Value	Unit
Collector - Emitter Voltage	$V_{CEO}$	40	Vdc
Collector - Base Voltage	$V_{CBO}$	60	Vdc
Emitter - Base Voltage	$V_{EBO}$	6.0	Vdc
Collector Current - Continuous	$I_C$	600	mAdc
Collector Current - Peak	$I_{CM}$	900	mAdc

#### THERMAL CHARACTERISTICS

Characteristic	Symbol	Max	Unit
Total Device Dissipation FR-5 Board (Note 1) @ $T_A = 25^\circ\text{C}$ Derate above $25^\circ\text{C}$	$P_D$	225 1.8	mW mW/ $^\circ\text{C}$
Thermal Resistance, Junction-to-Ambient	$R_{\theta JA}$	556	$^\circ\text{C}/\text{W}$
Total Device Dissipation Alumina Substrate (Note 2) @ $T_A = 25^\circ\text{C}$ Derate above $25^\circ\text{C}$	$P_D$	300 2.4	mW mW/ $^\circ\text{C}$
Thermal Resistance, Junction-to-Ambient	$R_{\theta JA}$	417	$^\circ\text{C}/\text{W}$
Junction and Storage Temperature	$T_J, T_{stg}$	-55 to +150	$^\circ\text{C}$

Stresses exceeding Maximum Ratings may damage the device. Maximum Ratings are stress ratings only. Functional operation above the Recommended Operating Conditions is not implied. Extended exposure to stresses above the Recommended Operating Conditions may affect device reliability.

\*Transient pulses must not cause the junction temperature to be exceeded.

1. FR-5 =  $1.0 \times 0.75 \times 0.062$  in.
2. Alumina =  $0.4 \times 0.3 \times 0.024$  in. 99.5% alumina.



ON Semiconductor®

<http://onsemi.com>

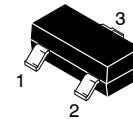
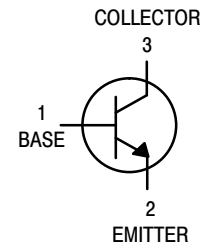

SOT-23 (TO-236)  
CASE 318  
STYLE 6

#### MARKING DIAGRAM

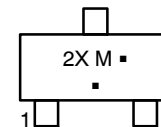

2X = Specific Device Code  
M = Date Code\*  
▪ = Pb-Free Package

(Note: Microdot may be in either location)

\*Date Code orientation and/or overbar may vary depending upon manufacturing location.

#### ORDERING INFORMATION

Device	Package	Shipping†
MMBT4401LT1G SMMBT4401LT1G	SOT-23 (Pb-Free)	3000 / Tape & Reel
MMBT4401LT3G	SOT-23 (Pb-Free)	10,000 / Tape & Reel

†For information on tape and reel specifications, including part orientation and tape sizes, please refer to our Tape and Reel Packaging Specifications Brochure, BRD8011/D.

# MMBT4401L, SMMBT4401L

## ELECTRICAL CHARACTERISTICS ( $T_A = 25^\circ\text{C}$ unless otherwise noted)

Characteristic	Symbol	Min	Max	Unit
<b>OFF CHARACTERISTICS</b>				
Collector - Emitter Breakdown Voltage (Note 3) ( $I_C = 1.0 \text{ mA dc}, I_B = 0$ )	$V_{(BR)CEO}$	40	-	Vdc
Collector - Base Breakdown Voltage ( $I_C = 0.1 \text{ mA dc}, I_E = 0$ )	$V_{(BR)CBO}$	60	-	Vdc
Emitter - Base Breakdown Voltage ( $I_E = 0.1 \text{ mA dc}, I_C = 0$ )	$V_{(BR)EBO}$	6.0	-	Vdc
Base Cutoff Current ( $V_{CE} = 35 \text{ Vdc}, V_{EB} = 0.4 \text{ Vdc}$ )	$I_{BEV}$	-	0.1	$\mu\text{A dc}$
Collector Cutoff Current ( $V_{CE} = 35 \text{ Vdc}, V_{EB} = 0.4 \text{ Vdc}$ )	$I_{CEX}$	-	0.1	$\mu\text{A dc}$

## ON CHARACTERISTICS (Note 3)

DC Current Gain ( $I_C = 0.1 \text{ mA dc}, V_{CE} = 1.0 \text{ Vdc}$ ) ( $I_C = 1.0 \text{ mA dc}, V_{CE} = 1.0 \text{ Vdc}$ ) ( $I_C = 10 \text{ mA dc}, V_{CE} = 1.0 \text{ Vdc}$ ) ( $I_C = 150 \text{ mA dc}, V_{CE} = 1.0 \text{ Vdc}$ ) ( $I_C = 500 \text{ mA dc}, V_{CE} = 2.0 \text{ Vdc}$ )	$h_{FE}$	20 40 80 100 40	- - - 300 -	-
Collector - Emitter Saturation Voltage ( $I_C = 150 \text{ mA dc}, I_B = 15 \text{ mA dc}$ ) ( $I_C = 500 \text{ mA dc}, I_B = 50 \text{ mA dc}$ )	$V_{CE(sat)}$	- -	0.4 0.75	Vdc
Base - Emitter Saturation Voltage ( $I_C = 150 \text{ mA dc}, I_B = 15 \text{ mA dc}$ ) ( $I_C = 500 \text{ mA dc}, I_B = 50 \text{ mA dc}$ )	$V_{BE(sat)}$	0.75 -	0.95 1.2	Vdc

## SMALL-SIGNAL CHARACTERISTICS

Current - Gain - Bandwidth Product ( $I_C = 20 \text{ mA dc}, V_{CE} = 10 \text{ Vdc}, f = 100 \text{ MHz}$ )	$f_T$	250	-	MHz
Collector - Base Capacitance ( $V_{CB} = 5.0 \text{ Vdc}, I_E = 0, f = 1.0 \text{ MHz}$ )	$C_{cb}$	-	6.5	pF
Emitter - Base Capacitance ( $V_{EB} = 0.5 \text{ Vdc}, I_C = 0, f = 1.0 \text{ MHz}$ )	$C_{eb}$	-	30	pF
Input Impedance ( $I_C = 1.0 \text{ mA dc}, V_{CE} = 10 \text{ Vdc}, f = 1.0 \text{ kHz}$ )	$h_{ie}$	1.0	15	$k\Omega$
Voltage Feedback Ratio ( $I_C = 1.0 \text{ mA dc}, V_{CE} = 10 \text{ Vdc}, f = 1.0 \text{ kHz}$ )	$h_{re}$	0.1	8.0	$\times 10^{-4}$
Small - Signal Current Gain ( $I_C = 1.0 \text{ mA dc}, V_{CE} = 10 \text{ Vdc}, f = 1.0 \text{ kHz}$ )	$h_{fe}$	40	500	-
Output Admittance ( $I_C = 1.0 \text{ mA dc}, V_{CE} = 10 \text{ Vdc}, f = 1.0 \text{ kHz}$ )	$h_{oe}$	1.0	30	$\mu\text{mhos}$

## SWITCHING CHARACTERISTICS

Delay Time	( $V_{CC} = 30 \text{ Vdc}, V_{EB} = 2.0 \text{ Vdc}, I_C = 150 \text{ mA dc}, I_{B1} = 15 \text{ mA dc}$ )	$t_d$	-	15	ns
Rise Time		$t_r$	-	20	
Storage Time	( $V_{CC} = 30 \text{ Vdc}, I_C = 150 \text{ mA dc}, I_{B1} = I_{B2} = 15 \text{ mA dc}$ )	$t_s$	-	225	ns
Fall Time		$t_f$	-	30	

3. Pulse Test: Pulse Width  $\leq 300 \mu\text{s}$ , Duty Cycle  $\leq 2.0\%$ .

## SWITCHING TIME EQUIVALENT TEST CIRCUITS

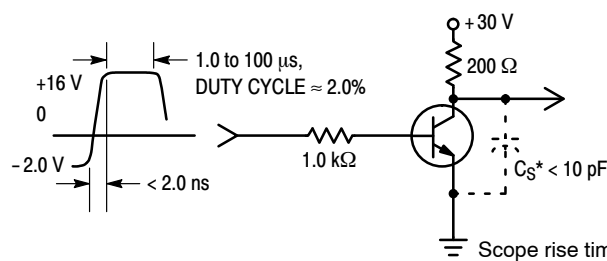

Figure 1. Turn-On Time

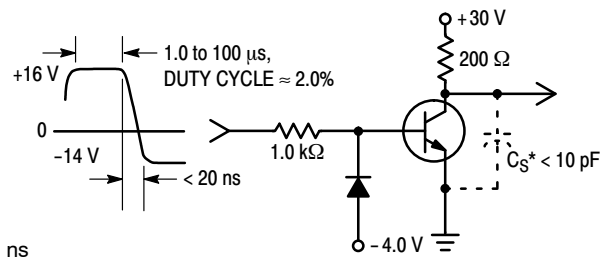

Figure 2. Turn-Off Time

# MMBT4401L, SMMBT4401L

## TRANSIENT CHARACTERISTICS

— 25°C    - - - 100°C

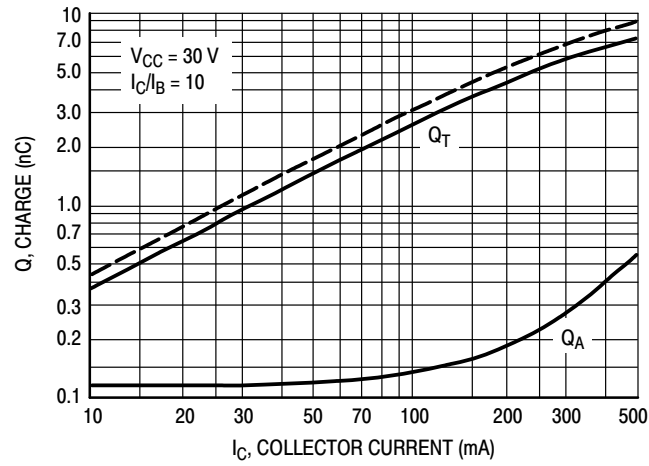

Figure 3. Charge Data

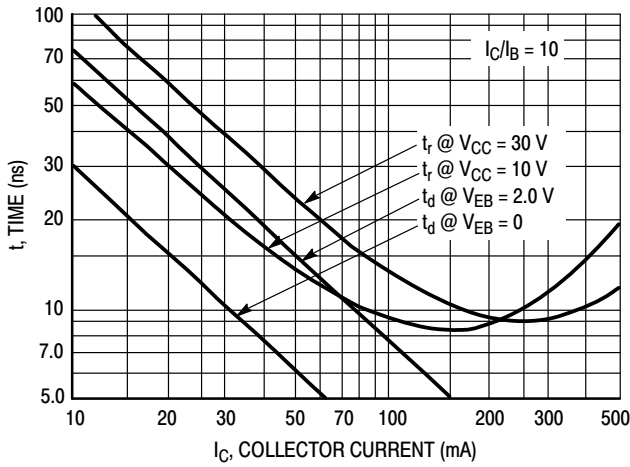

Figure 4. Turn-On Time

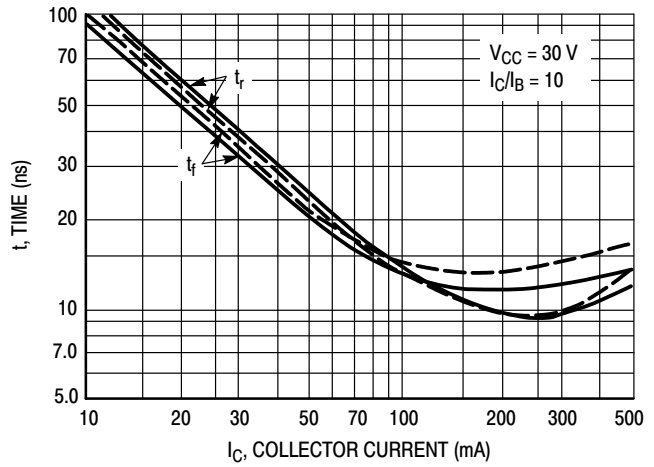

Figure 5. Rise and Fall Times

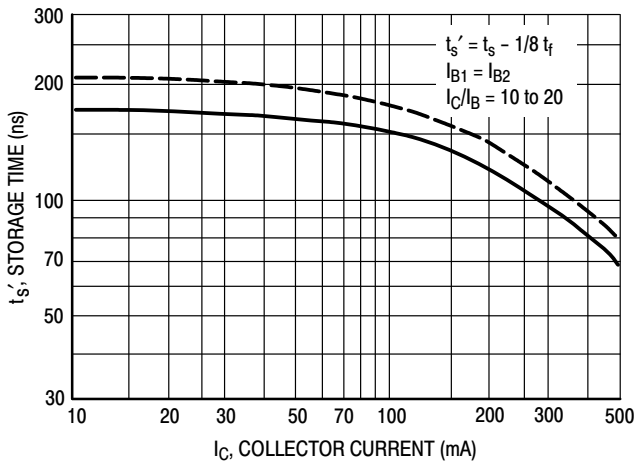

Figure 6. Storage Time

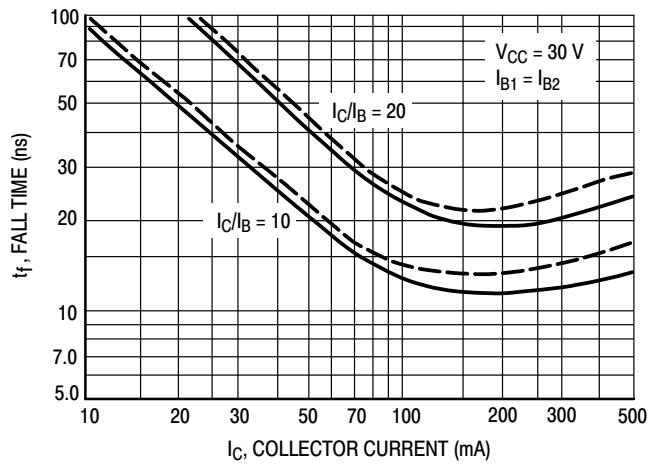

Figure 7. Fall Time

# MMBT4401L, SMMBT4401L

## SMALL-SIGNAL CHARACTERISTICS NOISE FIGURE

$V_{CE} = 10 \text{ Vdc}$ ,  $T_A = 25^\circ\text{C}$ ; Bandwidth = 1.0 Hz

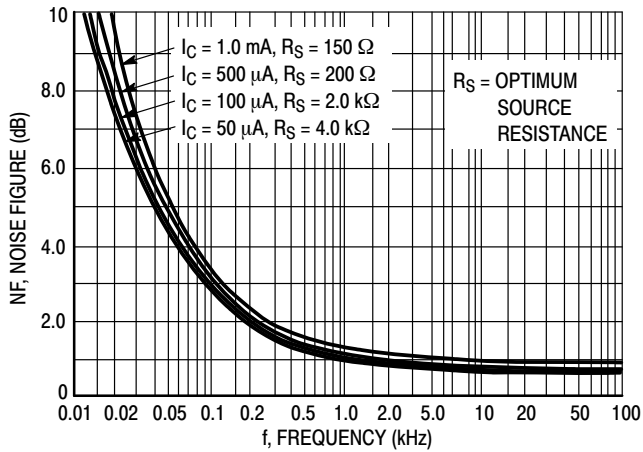

Figure 8. Frequency Effects

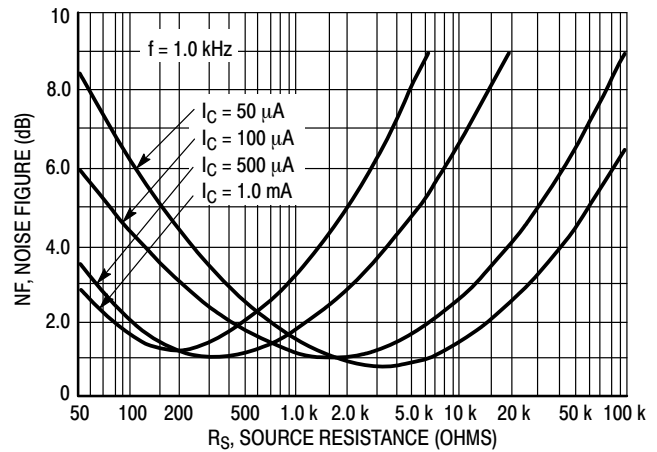

Figure 9. Source Resistance Effects

## h PARAMETERS

$V_{CE} = 10 \text{ Vdc}$ ,  $f = 1.0 \text{ kHz}$ ,  $T_A = 25^\circ\text{C}$

This group of graphs illustrates the relationship between  $h_{fe}$  and other “h” parameters for this series of transistors. To obtain these curves, a high-gain and a low-gain unit were selected from the MMBT4401LT1 lines, and the same units were used to develop the correspondingly numbered curves on each graph.

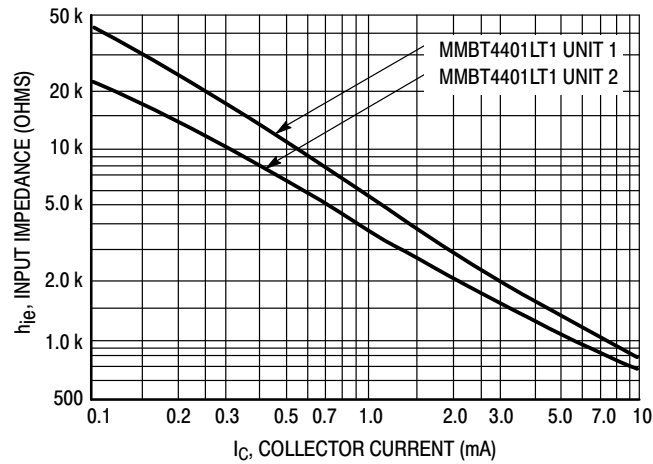

Figure 10. Input Impedance

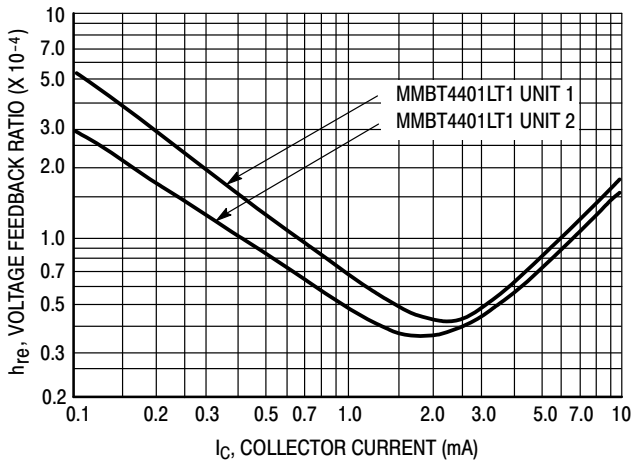

Figure 11. Voltage Feedback Ratio

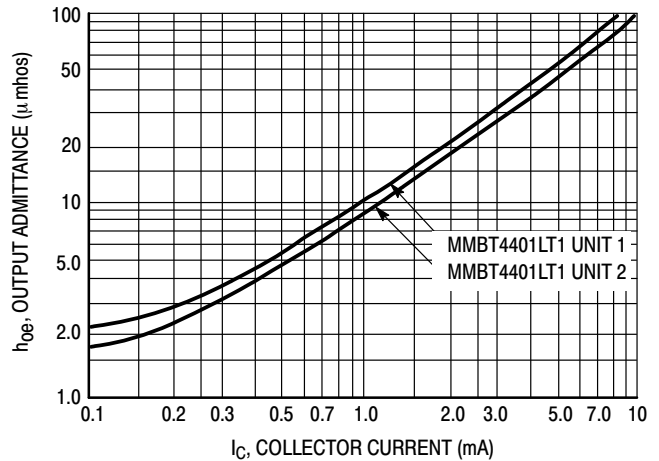

Figure 12. Output Admittance

# MMBT4401L, SMMBT4401L

## STATIC CHARACTERISTICS

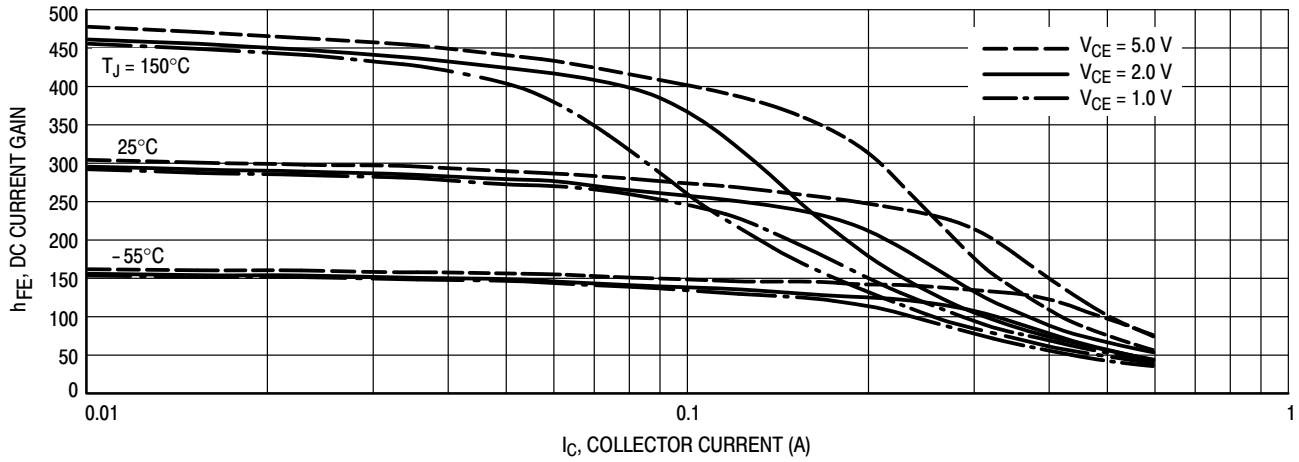

Figure 13. DC Current Gain

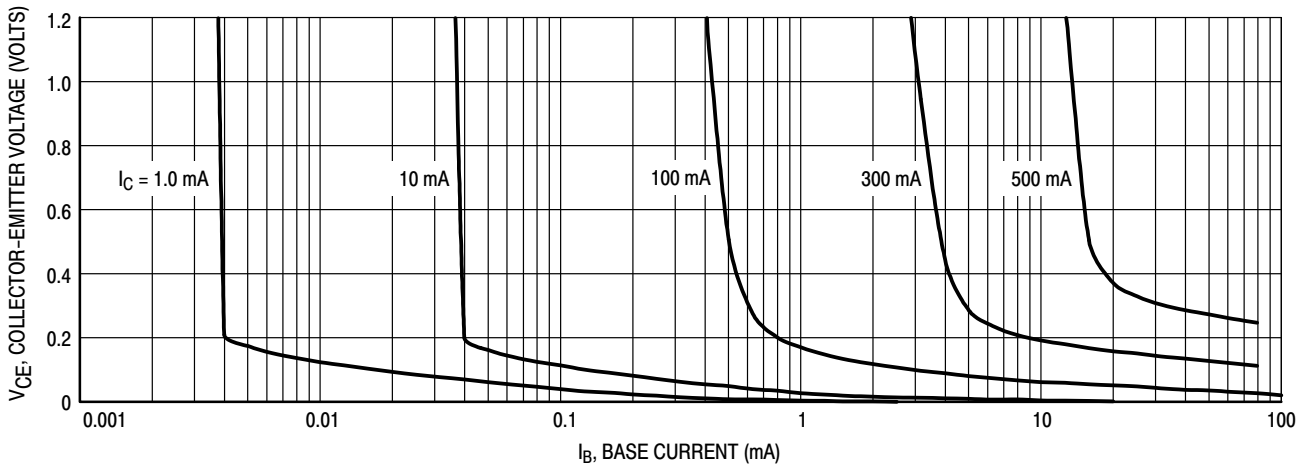

Figure 14. Collector Saturation Region

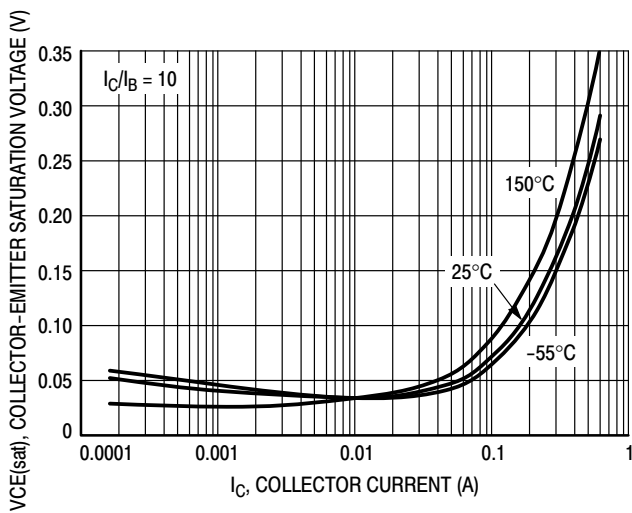

Figure 15. Collector-Emitter Saturation Voltage vs. Collector Current

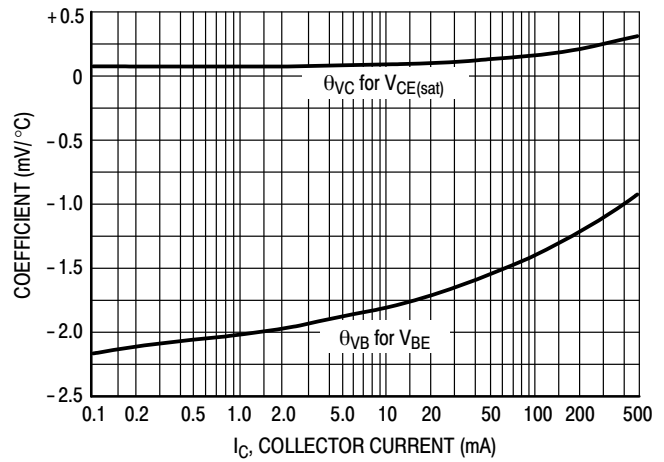
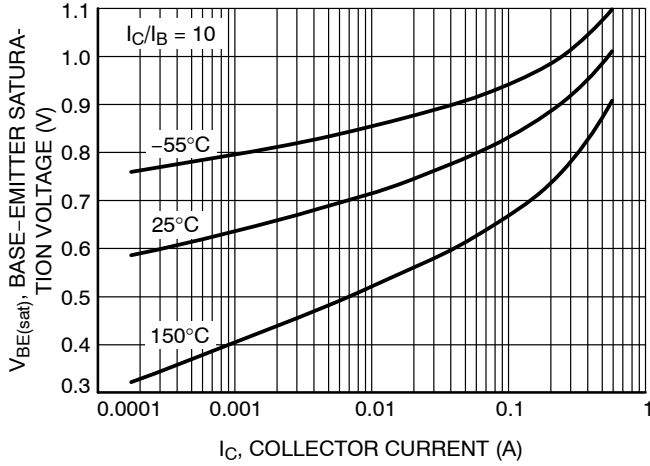

Figure 16. Temperature Coefficients

# MMBT4401L, SMMBT4401L

## STATIC CHARACTERISTICS



**Figure 17. Base-Emitter Saturation Voltage vs. Collector Current**

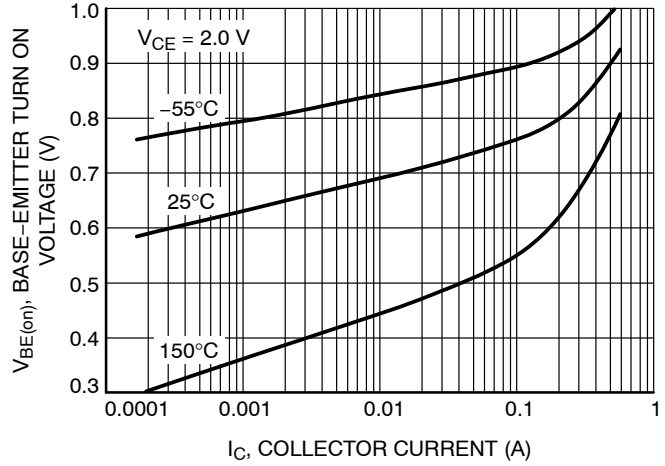

**Figure 18. Base-Emitter Turn On Voltage vs. Collector Current**

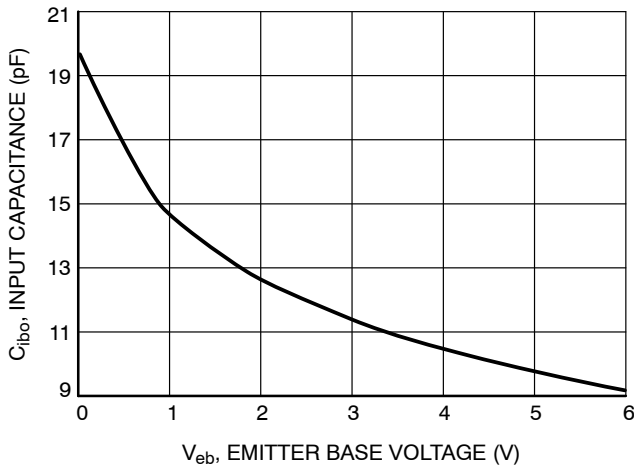

**Figure 19. Input Capacitance vs. Emitter Base Voltage**

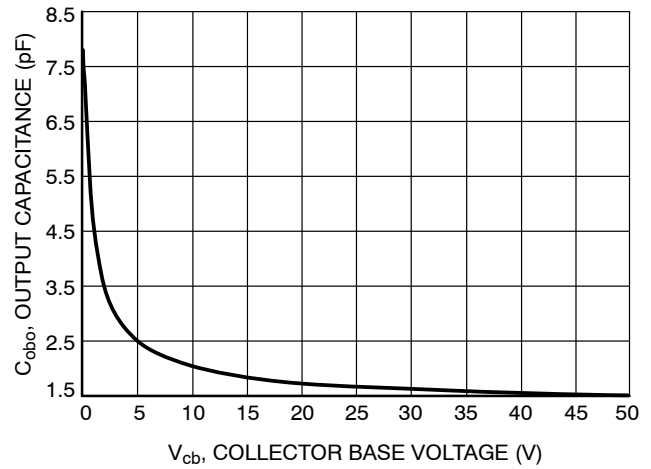

**Figure 20. Output Capacitance vs. Collector Base Voltage**

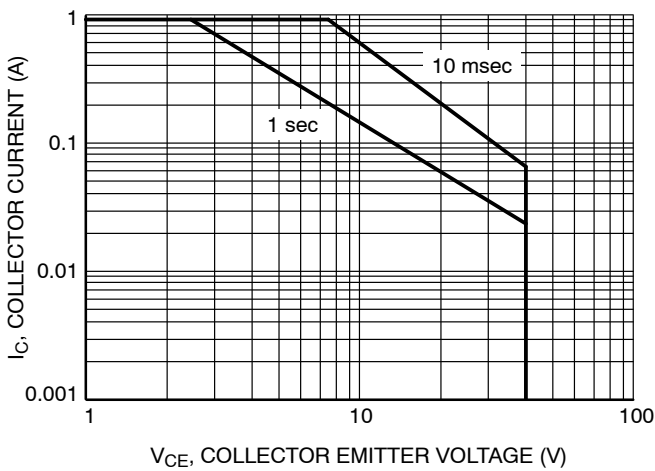

**Figure 21. Safe Operating Area**

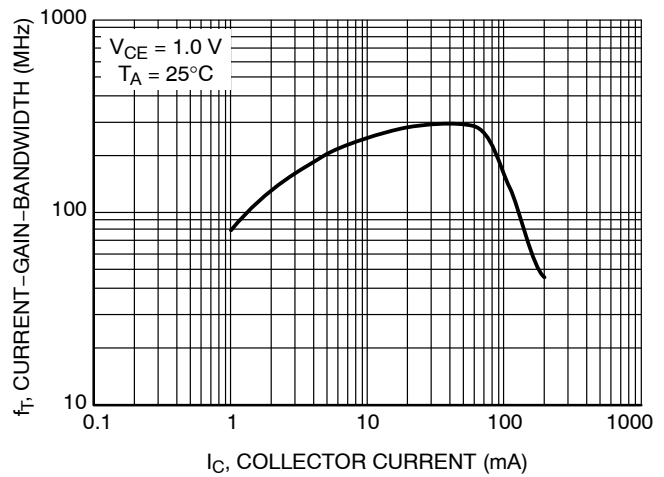
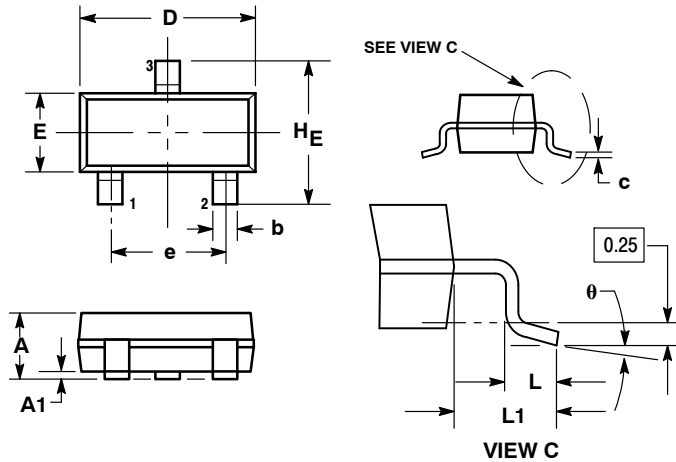

**Figure 22. Current-Gain-Bandwidth Product**

# MMBT4401L, SMMBT4401L

## PACKAGE DIMENSIONS

SOT-23 (TO-236)  
CASE 318-08  
ISSUE AP



NOTES:

1. DIMENSIONING AND TOLERANCING PER ANSI Y14.5M, 1982.
2. CONTROLLING DIMENSION: INCH.
3. MAXIMUM LEAD THICKNESS INCLUDES LEAD FINISH THICKNESS. MINIMUM LEAD THICKNESS IS THE MINIMUM THICKNESS OF BASE MATERIAL.
4. DIMENSIONS D AND E DO NOT INCLUDE MOLD FLASH, PROTRUSIONS OR GATE BURRS.

DIM	MILLIMETERS			INCHES		
	MIN	NOM	MAX	MIN	NOM	MAX
A	0.89	1.00	1.11	0.035	0.040	0.044
A1	0.01	0.06	0.10	0.001	0.002	0.004
b	0.37	0.44	0.50	0.015	0.018	0.020
c	0.09	0.13	0.18	0.003	0.005	0.007
D	2.80	2.90	3.04	0.110	0.114	0.120
E	1.20	1.30	1.40	0.047	0.051	0.055
e	1.78	1.90	2.04	0.070	0.075	0.081
L	0.10	0.20	0.30	0.004	0.008	0.012
L1	0.35	0.54	0.69	0.014	0.021	0.029
HE	2.10	2.40	2.64	0.083	0.094	0.104
θ	0°	---	10°	0°	---	10°

STYLE 6:

1. BASE
2. EMITTER
3. COLLECTOR

### SOLDERING FOOTPRINT\*

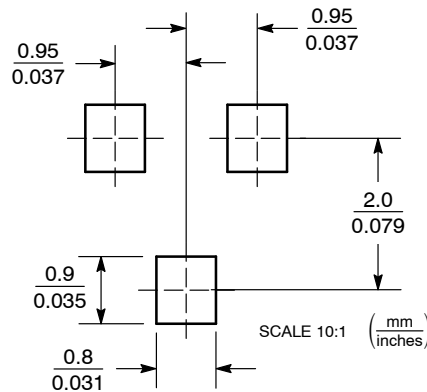

\*For additional information on our Pb-Free strategy and soldering details, please download the ON Semiconductor Soldering and Mounting Techniques Reference Manual, SOLDERRM/D.

ON Semiconductor and are registered trademarks of Semiconductor Components Industries, LLC (SCILLC). SCILLC reserves the right to make changes without further notice to any products herein. SCILLC makes no warranty, representation or guarantee regarding the suitability of its products for any particular purpose, nor does SCILLC assume any liability arising out of the application or use of any product or circuit, and specifically disclaims any and all liability, including without limitation special, consequential or incidental damages. "Typical" parameters which may be provided in SCILLC data sheets and/or specifications can and do vary in different applications and actual performance may vary over time. All operating parameters, including "Typicals" must be validated for each customer application by customer's technical experts. SCILLC does not convey any license under its patent rights nor the rights of others. SCILLC products are not designed, intended, or authorized for use as components in systems intended for surgical implant into the body, or other applications intended to support or sustain life, or for any other application in which the failure of the SCILLC product could create a situation where personal injury or death may occur. Should Buyer purchase or use SCILLC products for any such unintended or unauthorized application, Buyer shall indemnify and hold SCILLC and its officers, employees, subsidiaries, affiliates, and distributors harmless against all claims, costs, damages, and expenses, and reasonable attorney fees arising out of, directly or indirectly, any claim of personal injury or death associated with such unintended or unauthorized use, even if such claim alleges that SCILLC was negligent regarding the design or manufacture of the part. SCILLC is an Equal Opportunity/Affirmative Action Employer. This literature is subject to all applicable copyright laws and is not for resale in any manner.

### PUBLICATION ORDERING INFORMATION

**LITERATURE FULFILLMENT:**  
Literature Distribution Center for ON Semiconductor  
P.O. Box 5163, Denver, Colorado 80217 USA  
**Phone:** 303-675-2175 or 800-344-3860 Toll Free USA/Canada  
**Fax:** 303-675-2176 or 800-344-3867 Toll Free USA/Canada  
**Email:** orderlit@onsemi.com

**N. American Technical Support:** 800-282-9855 Toll Free  
USA/Canada  
**Europe, Middle East and Africa Technical Support:**  
Phone: 421 33 790 2910  
**Japan Customer Focus Center**  
Phone: 81-3-5817-1050

**ON Semiconductor Website:** [www.onsemi.com](http://www.onsemi.com)

**Order Literature:** <http://www.onsemi.com/orderlit>

For additional information, please contact your local Sales Representative

Компания «Life Electronics» занимается поставками электронных компонентов импортного и отечественного производства от производителей и со складов крупных дистрибьюторов Европы, Америки и Азии.

С конца 2013 года компания активно расширяет линейку поставок компонентов по направлению коаксиальный кабель, кварцевые генераторы и конденсаторы (керамические, пленочные, электролитические), за счёт заключения дистрибьюторских договоров

Мы предлагаем:

- Конкурентоспособные цены и скидки постоянным клиентам.
- Специальные условия для постоянных клиентов.
- Подбор аналогов.
- Поставку компонентов в любых объемах, удовлетворяющих вашим потребностям.
- Приемлемые сроки поставки, возможна ускоренная поставка.
- Доставку товара в любую точку России и стран СНГ.
- Комплексную поставку.
- Работу по проектам и поставку образцов.
- Формирование склада под заказчика.
- Сертификаты соответствия на поставляемую продукцию (по желанию клиента).
- Тестирование поставляемой продукции.
- Поставку компонентов, требующих военную и космическую приемку.
- Входной контроль качества.
- Наличие сертификата ISO.

В составе нашей компании организован Конструкторский отдел, призванный помогать разработчикам, и инженерам.

Конструкторский отдел помогает осуществить:

- Регистрацию проекта у производителя компонентов.
- Техническую поддержку проекта.
- Защиту от снятия компонента с производства.
- Оценку стоимости проекта по компонентам.
- Изготовление тестовой платы монтаж и пусконаладочные работы.



Тел: +7 (812) 336 43 04 (многоканальный)

Email: [org@lifeelectronics.ru](mailto:org@lifeelectronics.ru)