

Voltage Detector IC Series

# Counter Timer Built-in CMOS Voltage Detector IC



BD45xxx series BD46xxx series

●General Description

ROHM's BD45xxx and BD46xxx series are highly accurate, low current consumption Voltage Detector ICs. Because the counter timer delay circuit is built into these series, an external capacitor for the delay time setting is unnecessary. The lineup was established with low output types (Nch open drain and CMOS output) and detection voltages range from 2.3V to 4.8V in increments of 0.1V, so that the series may be selected according the application at hand.

●Features

- Counter Timer Built-in
- No delay time setting external capacitor required
- Ultra-low current consumption
- Two output types (Nch open drain and CMOS output)
- Package SSOP5 is similar to SOT-23-5 (JEDEC)

●Key Specifications

- Detection voltage: 2.3V to 4.8V (Typ.)  
0.1V steps
- High accuracy detection voltage: ±1.0%
- Ultra-low current consumption: 0.85µA (Typ.)
- Operating temperature range: -40°C to +105°C
- Three internal, fixed delay time: 50ms  
100ms  
200ms

●Package

SSOP5  2.90mm x 2.80mm x 1.25mm

●Applications

Circuits using microcontrollers or logic circuits that require a reset.

●Typical Application Circuit



(Open Drain Output Type)  
BD45xxx series



(CMOS Output Type)  
BD46xxx series

●Connection Diagram

SSOP5



●Pin Descriptions

PIN No.	Symbol	Function
1	ER	Manual Reset
2	SUB	Substrate *
3	GND	GND
4	VOUT	Reset Output
5	VDD	Power Supply Voltage

\*Connect the substrate to GND.

●Ordering Information

B		D		X		X		X		X		X		-		T		R	
Part Number	Output Type 45 : Open Drain 46 : CMOS			Reset Voltage Value 23 : 2.3V ↓ 0.1V step 48 : 4.8V			Counter Timer Delay Time Settings 5 : 50ms 1 : 100ms 2 : 200ms			Package G : SSOP5		Packaging and forming specification TR : Embossed tape and reel							

SSOP5



●Lineup

Table 1. Open Drain Output Type

Detection Voltage	Counter Timer Delay Time Settings					
	50ms		100ms		200ms	
	Marking	Part Number	Marking	Part Number	Marking	Part Number
4.8V	T0	BD45485	TS	BD45481	UJ	BD45482
4.7V	T1	BD45475	TT	BD45471	UK	BD45472
4.6V	T2	BD45465	TU	BD45461	UL	BD45462
4.5V	T3	BD45455	TV	BD45451	UM	BD45452
4.4V	T4	BD45445	TW	BD45441	UN	BD45442
4.3V	T5	BD45435	TX	BD45431	UP	BD45432
4.2V	T6	BD45425	TY	BD45421	UQ	BD45422
4.1V	T7	BD45415	TZ	BD45411	UR	BD45412
4.0V	T8	BD45405	U0	BD45401	US	BD45402
3.9V	T9	BD45395	U1	BD45391	UT	BD45392
3.8V	TA	BD45385	U2	BD45381	UU	BD45382
3.7V	TB	BD45375	U3	BD45371	UV	BD45372
3.6V	TC	BD45365	U4	BD45361	UW	BD45362
3.5V	TD	BD45355	U5	BD45351	UX	BD45352
3.4V	TE	BD45345	U6	BD45341	UY	BD45342
3.3V	TF	BD45335	U7	BD45331	UZ	BD45332
3.2V	TG	BD45325	U8	BD45321	V0	BD45322
3.1V	TH	BD45315	U9	BD45311	V1	BD45312
3.0V	TJ	BD45305	UA	BD45301	V2	BD45302
2.9V	TK	BD45295	UB	BD45291	V3	BD45292
2.8V	TL	BD45285	UC	BD45281	V4	BD45282
2.7V	TM	BD45275	UD	BD45271	V5	BD45272
2.6V	TN	BD45265	UE	BD45261	V6	BD45262
2.5V	TP	BD45255	UF	BD45251	V7	BD45252
2.4V	TQ	BD45245	UG	BD45241	V8	BD45242
2.3V	TR	BD45235	UH	BD45231	V9	BD45232

## ●Lineup - continued

Table 2. CMOS Output Type

Detection Voltage	Counter Timer Delay Time Settings					
	50ms		100ms		200ms	
	Marking	Part Number	Marking	Part Number	Marking	Part Number
4.8V	VA	BD46485	W2	BD46481	WU	BD46482
4.7V	VB	BD46475	W3	BD46471	WV	BD46472
4.6V	VC	BD46465	W4	BD46461	WW	BD46462
4.5V	VD	BD46455	W5	BD46451	WX	BD46452
4.4V	VE	BD46445	W6	BD46441	WY	BD46442
4.3V	VF	BD46435	W7	BD46431	WZ	BD46432
4.2V	VG	BD46425	W8	BD46421	X0	BD46422
4.1V	VH	BD46415	W9	BD46411	X1	BD46412
4.0V	VJ	BD46405	WA	BD46401	X2	BD46402
3.9V	VK	BD46395	WB	BD46391	X3	BD46392
3.8V	VL	BD46385	WC	BD46381	X4	BD46382
3.7V	VM	BD46375	WD	BD46371	X5	BD46372
3.6V	VN	BD46365	WE	BD46361	X6	BD46362
3.5V	VP	BD46355	WF	BD46351	X7	BD46352
3.4V	VQ	BD46345	WG	BD46341	X8	BD46342
3.3V	VR	BD46335	WH	BD46331	X9	BD46332
3.2V	VS	BD46325	WJ	BD46321	XA	BD46322
3.1V	VT	BD46315	WK	BD46311	XB	BD46312
3.0V	VU	BD46305	WL	BD46301	XC	BD46302
2.9V	VV	BD46295	WM	BD46291	XD	BD46292
2.8V	VW	BD46285	WN	BD46281	XE	BD46282
2.7V	VX	BD46275	WP	BD46271	XF	BD46272
4.8V	VY	BD46265	WQ	BD46261	XG	BD46262
4.7V	VZ	BD46255	WR	BD46251	XH	BD46252
4.6V	W0	BD46245	WS	BD46241	XJ	BD46242
4.5V	W1	BD46235	WT	BD46231	XK	BD46232

● Absolute maximum ratings

Parameter		Symbol	Limits	Unit
Power Supply Voltage		V <sub>DD-GND</sub>	-0.3 to +10	V
Output Voltage	Nch Open Drain Output	V <sub>OUT</sub>	GND-0.3 to +10	V
	CMOS Output		GND-0.3 to V <sub>DD</sub> +0.3	
Output Current		I <sub>o</sub>	60	mA
ER pin Voltage		V <sub>CT</sub>	GND-0.3 to V <sub>DD</sub> +0.3	V
Power Dissipation <sup>*1 *2</sup>		P <sub>d</sub>	540	mW
Operating Temperature		T <sub>opr</sub>	-40 to +105	°C
Ambient Storage Temperature		T <sub>stg</sub>	-55 to +125	°C

\*1 Reduced by 5.4mW/°C when used over 25°C.

\*2 When mounted on ROHM standard circuit board (70mmx70mmx1.6mm, glass epoxy board).

● Electrical characteristics (Unless Otherwise Specified Ta=-40 to 105°C)

Parameter	Symbol	Condition	Limit			Unit	
			Min.	Typ.	Max.		
Detection Voltage	V <sub>DET</sub>	V <sub>DD</sub> =H→L, R <sub>L</sub> =470kΩ <sup>*1</sup>	V <sub>DET</sub> (T) x0.99	V <sub>DET</sub> (T)	V <sub>DET</sub> (T) x1.01	V	
		V <sub>DET</sub> =2.5V	T <sub>a</sub> =+25°C	2.475	2.5		2.525
			T <sub>a</sub> =-40°C to 85°C	2.417	-		2.580
			T <sub>a</sub> =85°C to 105°C	2.422	-		2.598
		V <sub>DET</sub> =3.0V	T <sub>a</sub> =+25°C	2.970	3.0		3.030
			T <sub>a</sub> =-40°C to 85°C	2.901	-		3.095
			T <sub>a</sub> =85°C to 105°C	2.906	-		3.117
		V <sub>DET</sub> =3.3V	T <sub>a</sub> =+25°C	3.267	3.3		3.333
			T <sub>a</sub> =-40°C to 85°C	3.191	-		3.405
			T <sub>a</sub> =85°C to 105°C	3.196	-		3.429
		V <sub>DET</sub> =4.2V	T <sub>a</sub> =+25°C	4.158	4.2		4.242
			T <sub>a</sub> =-40°C to 85°C	4.061	-		4.334
T <sub>a</sub> =85°C to 105°C	4.068		-	4.364			
V <sub>DET</sub> =4.8V	T <sub>a</sub> =+25°C	4.752	4.8	4.848			
	T <sub>a</sub> =-40°C to 85°C	4.641	-	4.953			
	T <sub>a</sub> =85°C to 105°C	4.649	-	4.988			
Detection Voltage Temperature coefficient	V <sub>DET</sub> /ΔT	-40°C to +105°C	-	±100	±360	ppm/°C	
Hysteresis Voltage	ΔV <sub>DET</sub>	V <sub>DD</sub> =L→H→L, R <sub>L</sub> =470kΩ	V <sub>DET</sub> (T) x0.03	V <sub>DET</sub> (T) x0.05	V <sub>DET</sub> (T) x0.08	V	
'High' Output Delay time	t <sub>PLH</sub>	C <sub>L</sub> =100pF, R <sub>L</sub> =100kΩ <sup>*1, *2, *3</sup>	BD45xx5, BD46xx5	45	50	55	ms
			BD45xx1, BD46xx1	90	100	110	
			BD45xx2, BD46xx2	180	200	220	
Circuit Current when ON	I <sub>DD1</sub>	V <sub>DD</sub> =V <sub>DET</sub> -0.2V, V <sub>ER</sub> =0V V <sub>DET</sub> =2.3V to 3.1V <sup>*1</sup>	-	0.70	2.10	μA	
		V <sub>DD</sub> =V <sub>DET</sub> -0.2V, V <sub>ER</sub> =0V V <sub>DET</sub> =2.3V to 3.1V	-	0.70	2.85		
		V <sub>DD</sub> =V <sub>DET</sub> -0.2V, V <sub>ER</sub> =0V V <sub>DET</sub> =3.2V to 4.2V <sup>*1</sup>	-	0.75	2.25		
		V <sub>DD</sub> =V <sub>DET</sub> -0.2V, V <sub>ER</sub> =0V V <sub>DET</sub> =3.2V to 4.2V	-	0.75	3.00		
		V <sub>DD</sub> =V <sub>DET</sub> -0.2V, V <sub>ER</sub> =0V V <sub>DET</sub> =4.3V to 4.8V <sup>*1</sup>	-	0.80	2.40		
		V <sub>DD</sub> =V <sub>DET</sub> -0.2V, V <sub>ER</sub> =0V V <sub>DET</sub> =4.3V to 4.8V	-	0.80	3.15		
Circuit Current when OFF	I <sub>DD2</sub>	V <sub>DD</sub> =V <sub>DET</sub> +0.2V, V <sub>ER</sub> =0V V <sub>DET</sub> =2.3V to 3.1V <sup>*1</sup>	-	0.75	2.25	μA	
		V <sub>DD</sub> =V <sub>DET</sub> +0.2V, V <sub>ER</sub> =0V V <sub>DET</sub> =2.3V to 3.1V	-	0.75	4.28		
		V <sub>DD</sub> =V <sub>DET</sub> +0.2V, V <sub>ER</sub> =0V V <sub>DET</sub> =3.2V to 4.2V <sup>*1</sup>	-	0.80	2.40		
		V <sub>DD</sub> =V <sub>DET</sub> +0.2V, V <sub>ER</sub> =0V V <sub>DET</sub> =3.2V to 4.2V	-	0.80	4.50		
		V <sub>DD</sub> =V <sub>DET</sub> +0.2V, V <sub>ER</sub> =0V V <sub>DET</sub> =4.3V to 4.8V <sup>*1</sup>	-	0.85	2.55		
		V <sub>DD</sub> =V <sub>DET</sub> +0.2V, V <sub>ER</sub> =0V V <sub>DET</sub> =4.3V to 4.8V	-	0.85	4.73		

V<sub>DET</sub>(T): Standard Detection Voltage (2.3V to 4.8V, 0.1V step)

R<sub>L</sub>: Pull-up resistor to be connected between V<sub>OUT</sub> and power supply.

C<sub>L</sub>: Capacitor to be connected between V<sub>OUT</sub> and GND.

\*1 Guarantee is Ta=25°C.

\*2 t<sub>PLH</sub>: V<sub>DD</sub>=(V<sub>DET</sub>(T)-0.5V)→(V<sub>DET</sub>(T)+0.5V)

\*3 t<sub>PLH</sub>: V<sub>DD</sub>=Please set the rise up time between V<sub>DD</sub>=0→V<sub>DET</sub> to more than 100μs.

Attention: Please connect the GND when you don't use 'ER'

## ●Electrical characteristics (Unless Otherwise Specified Ta=-40 to 105°C) - continued

Parameter	Symbol	Condition	Limit			Unit
			Min.	Typ.	Max.	
Operating Voltage Range	VOPL	VOL≤0.4V, RL=470kΩ, Ta=25 to 105°C	0.95	-	-	V
		VOL≤0.4V, RL=470kΩ, Ta=-40 to 25°C	1.20	-	-	
'High' Output Voltage (Pch)	VOH	VDD=4.8V, ISOURCE= 1.0 mA, VDET(2.3V to 4.2V)	VDD-0.5	-	-	V
		VDD=6.0V, ISOURCE= 1.2 mA, VDET(4.3V to 4.8V)	VDD-0.5	-	-	
'Low' Output Voltage (Nch)	VOL	VDD=1.2V, ISINK = 0.45 mA	-	-	0.3	V
		VDD=2.4V, ISINK = 1.3 mA, VDET(2.7V to 4.8V)	-	-	0.3	
Leak Current when OFF	I <sub>leak</sub>	VDD=VDS=10V	-	-	0.1	μA
ER Pin 'H' Voltage	VEH		2.0	-	-	V
ER Pin 'L' Voltage	VEL		-	-	0.8	V
ER Pin Input Current	IEL		-	1	10	μA

VDET(T):Standard Detection Voltage (2.3V to 4.8V, 0.1V step)

RL :Pull-up resistor to be connected between VOUT and power supply.

CL :Capacitor to be connected between VOUT and GND.

\*1 Guarantee is Ta=25°C.

Attention: Please connect the GND when you don't use 'ER'

●Block Diagrams



Fig.1 BD45xxx Series



Fig.2 BD46xxx Series

● Typical Performance Curves



Fig.3 Circuit Current



Fig.4 "Low" Output Current



Fig.5 "High" Output Current



Fig.6 I/O Characteristics

● Typical Performance Curves – continued



Fig.7 ER Terminal Threshold Voltage



Fig.8 ER Terminal Input Current



Fig.9 Detection Voltage Release Voltage



Fig.10 Circuit Current when ON (VDET-0.2V)



● Typical Performance Curves – continued



Fig.11 Circuit Current when OFF



Fig.12 Operating Limit Voltage



Fig.13 Output Delay Time  
"Low"→"High"



Fig.14 Output Delay Time  
"High"→"Low"

● Application Information

Explanation of Operation

For both the open drain type (Fig.15) and the CMOS output type (Fig.16), the detection and release voltages are used as threshold voltages. When the voltage applied to the V<sub>DD</sub> pins reaches the applicable threshold voltage, the V<sub>OUT</sub> terminal voltage switches from either “High” to “Low” or from “Low” to “High”. Because the BD45xxx series uses an open drain output type, it is necessary to connect either a pull-up resistor to V<sub>DD</sub> or another power supply if needed [The output “High” voltage (V<sub>OUT</sub>) in this case becomes V<sub>DD</sub> or the voltage of the other power supply].

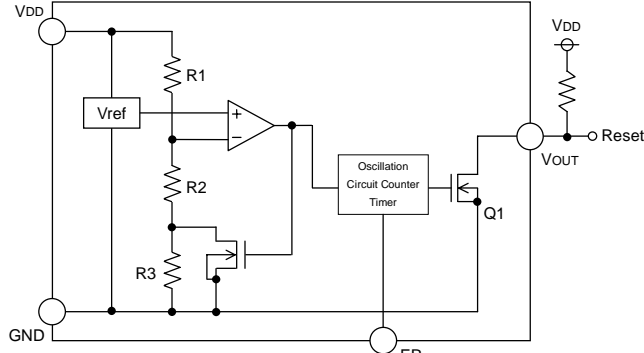

Fig.15 (BD45xxx Type Internal Block Diagram)



Fig.16 (BD46xxx Type Internal Block Diagram)

Reference Data

Examples of Leading (t<sub>PLH</sub>) and Falling (t<sub>PHL</sub>) Output

Part Number	t <sub>PLH</sub> [ms]	t <sub>PHL</sub> [μs]
BD45275G	50	18
BD46275G	50	18

V<sub>DD</sub>=2.2V→3.2V

V<sub>DD</sub>=3.2V→2.2V

\*This data is for reference only.

The figures will vary with the application, so please confirm actual operating conditions before use.

Timing Waveform

Example: The following shows the relationship between the input voltages V<sub>DD</sub>, the output voltage V<sub>OUT</sub> and ER terminal when the input power supply voltage V<sub>DD</sub> is made to sweep up and sweep down (the circuits are those in Fig. 12 and 13).



Fig.17 Timing Waveform

- ① When the power supply is turned on, the output is unstable from after over the operating limit voltage (V<sub>OPL</sub>) until t<sub>PHL</sub>. Therefore it is possible that the reset signal is not outputted when the rise time of V<sub>DD</sub> is faster than t<sub>PHL</sub>.
- ② When V<sub>DD</sub> is greater than V<sub>OPL</sub> but less than the reset release voltage (V<sub>DETE</sub> + ΔV<sub>DETE</sub>), the output voltages will switch to Low.
- ③ If V<sub>DD</sub> exceeds the reset release voltage (V<sub>DETE</sub> + ΔV<sub>DETE</sub>), the counter timer start and V<sub>OUT</sub> switches from L to H.
- ④ When more than the high level voltage is supplied to the ER terminal, V<sub>OUT</sub> comes to “L” after t<sub>PLH</sub> delay time. Therefore, a time when ER terminal is “H” is necessary for 100μsec or more.
- ⑤ When the ER terminal switches to Low, the counter timer starts to operate, a delay of t<sub>PLH</sub> occurs, and V<sub>OUT</sub> switches from “L” to “H”.
- ⑥ If V<sub>DD</sub> drops below the detection voltage (V<sub>DETE</sub>) when the power supply is powered down or when there is a power supply fluctuation, V<sub>OUT</sub> switches to L (with a delay of t<sub>PHL</sub>).
- ⑦ The potential difference between the detection voltage and the release voltage is known as the hysteresis width (ΔV<sub>DETE</sub>). The system is designed such that the output does not toggle with power supply fluctuations within this hysteresis width, preventing malfunctions due to noise.

These time changes by the application and use it, please verify and confirm using practical applications.

●Circuit Applications

1) Examples of common power supply detection reset circuits.



Fig.18 Open Drain Output Type

Application examples of BD45xxx series (Open Drain output type) and BD46xxx series (CMOS output type) are shown below.

CASE1: Power supply of the microcontroller ( $V_{DD2}$ ) differs from the power supply of the reset detection ( $V_{DD1}$ ).

Use an open drain output type (BD45xxx) with a load resistance  $R_L$  as shown Fig.18.



Fig.19 CMOS Output Type

CASE2: Power supply of the microcontroller ( $V_{DD1}$ ) is same as the power supply of the reset detection ( $V_{DD1}$ ).

Use a CMOS output type (BD46xxx) device or an open drain output type (BD45xxx) device with a pull up resistor between the output and  $V_{DD1}$ .

When a capacitance  $C_L$  for noise filtering is connected to the  $V_{OUT}$  pin (the reset signal input terminal of the microcontroller), please take into account the waveform of the rise and fall of the output voltage ( $V_{OUT}$ ).

2) The following is an example of a circuit application in which an OR connection between two types of detection voltage resets the microcontroller.



Fig. 20

To reset the microcontroller when many independent power supplies are used in the system, OR connect an open drain output type (BD45xxx series) to the microcontroller's input with pull-up resistor to the supply voltage of the microcontroller ( $V_{DD3}$ ) as shown in Fig. 20. By pulling-up to  $V_{DD3}$ , output "High" voltage of micro-controller power supply is possible.

3) Examples of the power supply with resistor dividers.

In applications wherein the power supply voltage of an IC comes from a resistor divider circuit, an in-rush current will flow into the circuit when the output level switches from “High” to “Low” or vice versa. In-rush current is a sudden surge of current that flows from the power supply (VDD) to ground (GND) as the output logic changes its state. This current flow may cause malfunction in the systems operation such as output oscillations, etc.



Fig. 21

When an in-rush current (I1) flows into the circuit (Refer to Fig. 21) at the time when output switches from “Low” to “High”, a voltage drop of  $I1 \times R2$  (input resistor) will occur in the circuit causing the VDD supply voltage to decrease. When the VDD voltage drops below the detection voltage, the output will switch from “High” to “Low”. While the output voltage is at “Low” condition, in-rush current will stop flowing and the voltage drop will be reduced. As a result, the output voltage will switch again from “Low” to “High” which causes an in-rush current and a voltage drop. This operation repeats and will result to oscillation.



Fig. 22 Current Consumption vs. Power Supply Voltage

**●Operational Notes**

- 1) Absolute maximum ratings  
Operating the IC over the absolute maximum ratings may damage the IC. The damage can either be a short circuit between pins or an open circuit between pins. Therefore, it is important to consider circuit protection measures, such as adding a fuse, in case the IC is operated over the absolute maximum ratings.
- 2) Ground Voltage  
The voltage of the ground pin must be the lowest voltage of all pins of the IC at all operating conditions. Ensure that no pins are at a voltage below the ground pin at any time, even during transient condition.
- 3) Recommended operating conditions  
These conditions represent a range within which the expected characteristics of the IC can be approximately obtained. The electrical characteristics are guaranteed under the conditions of each parameter.
- 4) Bypass Capacitor for Noise Rejection  
To help reject noise, put a 1 $\mu$ F capacitor between V<sub>DD</sub> pin and GND and 1000pF capacitor between V<sub>OUT</sub> pin and GND. Be careful when using extremely big capacitor as transient response will be affected.
- 5) Short between pins and mounting errors  
Be careful when mounting the IC on printed circuit boards. The IC may be damaged if it is mounted in a wrong orientation or if pins are shorted together. Short circuit may be caused by conductive particles caught between the pins.
- 6) Operation under strong electromagnetic field  
Operating the IC in the presence of a strong electromagnetic field may cause the IC to malfunction.
- 7) The V<sub>DD</sub> line impedance might cause oscillation because of the detection current.
- 8) A V<sub>DD</sub> to GND capacitor (as close connection as possible) should be used in high V<sub>DD</sub> line impedance condition.
- 9) Lower than the minimum input voltage puts the V<sub>OUT</sub> in high impedance state, and it must be V<sub>DD</sub> in pull up (V<sub>DD</sub>) condition.
- 10) This IC has extremely high impedance terminals. Small leak current due to the uncleanness of PCB surface might cause unexpected operations. Application values in these conditions should be selected carefully. If the leakage of about 1M $\Omega$  is assumed between the ER terminal and the GND terminal, 100k $\Omega$  connection between the ER terminal and the V<sub>DD</sub> terminal would be recommended. If the leakage is assumed between the V<sub>OUT</sub> terminal and the GND terminal, the pull-up resistor should be less than 1/10 of the assumed leak resistance.
- 11) External parameters  
The recommended parameter range for R<sub>L</sub> is 50k $\Omega$  to 1M $\Omega$ . There are many factors (board layout, etc) that can affect characteristics. Please verify and confirm using practical applications.
- 12) Power on reset operation  
Please note that the power on reset output varies with the V<sub>DD</sub> rise time. Please verify the behavior in the actual operation.
- 13) Testing on application boards  
When testing the IC on an application board, connecting a capacitor directly to a low-impedance output pin may subject the IC to stress. Always discharge capacitors completely after each process or step. The IC's power supply should always be turned off completely before connecting or removing it from the test setup during the inspection process. To prevent damage from static discharge, ground the IC during assembly and use similar precautions during transport and storage.
- 14) Rush current  
When power is first supplied to the IC, rush current may flow instantaneously. It is possible that the charge current to the parasitic capacitance of internal photo diode or the internal logic may be unstable. Therefore, give special consideration to power coupling capacitance, power wiring, width of GND wiring, and routing of connections.

# Notice

## ●General Precaution

- 1) Before you use our Products, you are requested to carefully read this document and fully understand its contents. ROHM shall not be in any way responsible or liable for failure, malfunction or accident arising from the use of any ROHM's Products against warning, caution or note contained in this document.
- 2) All information contained in this document is current as of the issuing date and subject to change without any prior notice. Before purchasing or using ROHM's Products, please confirm the latest information with a ROHM sales representative.

## ●Precaution on using ROHM Products

- 1) Our Products are designed and manufactured for application in ordinary electronic equipments (such as AV equipment, OA equipment, telecommunication equipment, home electronic appliances, amusement equipment, etc.). If you intend to use our Products in devices requiring extremely high reliability (such as medical equipment, transport equipment, traffic equipment, aircraft/spacecraft, nuclear power controllers, fuel controllers, car equipment including car accessories, safety devices, etc.) and whose malfunction or failure may cause loss of human life, bodily injury or serious damage to property ("Specific Applications"), please consult with the ROHM sales representative in advance. Unless otherwise agreed in writing by ROHM in advance, ROHM shall not be in any way responsible or liable for any damages, expenses or losses incurred by you or third parties arising from the use of any ROHM's Products for Specific Applications.
- 2) ROHM designs and manufactures its Products subject to strict quality control system. However, semiconductor products can fail or malfunction at a certain rate. Please be sure to implement, at your own responsibilities, adequate safety measures including but not limited to fail-safe design against the physical injury, damage to any property, which a failure or malfunction of our Products may cause. The following are examples of safety measures:
  - [a] Installation of protection circuits or other protective devices to improve system safety
  - [b] Installation of redundant circuits to reduce the impact of single or multiple circuit failure
- 3) Our Products are designed and manufactured for use under standard conditions and not under any special or extraordinary environments or conditions, as exemplified below. Accordingly, ROHM shall not be in any way responsible or liable for any damages, expenses or losses arising from the use of any ROHM's Products under any special or extraordinary environments or conditions. If you intend to use our Products under any special or extraordinary environments or conditions (as exemplified below), your independent verification and confirmation of product performance, reliability, etc. prior to use, must be necessary:
  - [a] Use of our Products in any types of liquid, including water, oils, chemicals, and organic solvents
  - [b] Use of our Products outdoors or in places where the Products are exposed to direct sunlight or dust
  - [c] Use of our Products in places where the Products are exposed to sea wind or corrosive gases, including Cl<sub>2</sub>, H<sub>2</sub>S, NH<sub>3</sub>, SO<sub>2</sub>, and NO<sub>2</sub>
  - [d] Use of our Products in places where the Products are exposed to static electricity or electromagnetic waves
  - [e] Use of our Products in proximity to heat-producing components, plastic cords, or other flammable items
  - [f] Sealing or coating our Products with resin or other coating materials
  - [g] Use of our Products without cleaning residue of flux (even if you use no-clean type fluxes, cleaning residue of flux is recommended); or Washing our Products by using water or water-soluble cleaning agents for cleaning residue after soldering
  - [h] Use of the Products in places subject to dew condensation
- 4) The Products are not subject to radiation-proof design.
- 5) Please verify and confirm characteristics of the final or mounted products in using the Products.
- 6) In particular, if a transient load (a large amount of load applied in a short period of time, such as pulse) is applied, confirmation of performance characteristics after on-board mounting is strongly recommended. Avoid applying power exceeding normal rated power; exceeding the power rating under steady-state loading condition may negatively affect product performance and reliability.
- 7) De-rate Power Dissipation (Pd) depending on Ambient temperature (Ta). When used in sealed area, confirm the actual ambient temperature.
- 8) Confirm that operation temperature is within the specified range described in the product specification.
- 9) ROHM shall not be in any way responsible or liable for failure induced under deviant condition from what is defined in this document.

**●Precaution for Mounting / Circuit board design**

- 1) When a highly active halogenous (chlorine, bromine, etc.) flux is used, the residue of flux may negatively affect product performance and reliability.
- 2) In principle, the reflow soldering method must be used; if flow soldering method is preferred, please consult with the ROHM representative in advance.

For details, please refer to ROHM Mounting specification

**●Precautions Regarding Application Examples and External Circuits**

- 1) If change is made to the constant of an external circuit, please allow a sufficient margin considering variations of the characteristics of the Products and external components, including transient characteristics, as well as static characteristics.
- 2) You agree that application notes, reference designs, and associated data and information contained in this document are presented only as guidance for Products use. Therefore, in case you use such information, you are solely responsible for it and you must exercise your own independent verification and judgment in the use of such information contained in this document. ROHM shall not be in any way responsible or liable for any damages, expenses or losses incurred by you or third parties arising from the use of such information.

**●Precaution for Electrostatic**

This Product is electrostatic sensitive product, which may be damaged due to electrostatic discharge. Please take proper caution in your manufacturing process and storage so that voltage exceeding the Products maximum rating will not be applied to Products. Please take special care under dry condition (e.g. Grounding of human body / equipment / solder iron, isolation from charged objects, setting of Ionizer, friction prevention and temperature / humidity control).

**●Precaution for Storage / Transportation**

- 1) Product performance and soldered connections may deteriorate if the Products are stored in the places where:
  - [a] the Products are exposed to sea winds or corrosive gases, including Cl<sub>2</sub>, H<sub>2</sub>S, NH<sub>3</sub>, SO<sub>2</sub>, and NO<sub>2</sub>
  - [b] the temperature or humidity exceeds those recommended by ROHM
  - [c] the Products are exposed to direct sunshine or condensation
  - [d] the Products are exposed to high Electrostatic
- 2) Even under ROHM recommended storage condition, solderability of products out of recommended storage time period may be degraded. It is strongly recommended to confirm solderability before using Products of which storage time is exceeding the recommended storage time period.
- 3) Store / transport cartons in the correct direction, which is indicated on a carton with a symbol. Otherwise bent leads may occur due to excessive stress applied when dropping of a carton.
- 4) Use Products within the specified time after opening a humidity barrier bag. Baking is required before using Products of which storage time is exceeding the recommended storage time period.

**●Precaution for Product Label**

QR code printed on ROHM Products label is for ROHM's internal use only.

**●Precaution for Disposition**

When disposing Products please dispose them properly using an authorized industry waste company.

**●Precaution for Foreign Exchange and Foreign Trade act**

Since our Products might fall under controlled goods prescribed by the applicable foreign exchange and foreign trade act, please consult with ROHM representative in case of export.

**●Precaution Regarding Intellectual Property Rights**

- 1) All information and data including but not limited to application example contained in this document is for reference only. ROHM does not warrant that foregoing information or data will not infringe any intellectual property rights or any other rights of any third party regarding such information or data. ROHM shall not be in any way responsible or liable for infringement of any intellectual property rights or other damages arising from use of such information or data.:
- 2) No license, expressly or implied, is granted hereby under any intellectual property rights or other rights of ROHM or any third parties with respect to the information contained in this document.

●Other Precaution

- 1) The information contained in this document is provided on an "as is" basis and ROHM does not warrant that all information contained in this document is accurate and/or error-free. ROHM shall not be in any way responsible or liable for any damages, expenses or losses incurred by you or third parties resulting from inaccuracy or errors of or concerning such information.
- 2) This document may not be reprinted or reproduced, in whole or in part, without prior written consent of ROHM.
- 3) The Products may not be disassembled, converted, modified, reproduced or otherwise changed without prior written consent of ROHM.
- 4) In no event shall you use in any way whatsoever the Products and the related technical information contained in the Products or this document for any military purposes, including but not limited to, the development of mass-destruction weapons.
- 5) The proper names of companies or products described in this document are trademarks or registered trademarks of ROHM, its affiliated companies or third parties.



Компания «Life Electronics» занимается поставками электронных компонентов импортного и отечественного производства от производителей и со складов крупных дистрибьюторов Европы, Америки и Азии.

С конца 2013 года компания активно расширяет линейку поставок компонентов по направлению коаксиальный кабель, кварцевые генераторы и конденсаторы (керамические, пленочные, электролитические), за счёт заключения дистрибьюторских договоров

Мы предлагаем:

- Конкурентоспособные цены и скидки постоянным клиентам.
- Специальные условия для постоянных клиентов.
- Подбор аналогов.
- Поставку компонентов в любых объемах, удовлетворяющих вашим потребностям.
- Приемлемые сроки поставки, возможна ускоренная поставка.
- Доставку товара в любую точку России и стран СНГ.
- Комплексную поставку.
- Работу по проектам и поставку образцов.
- Формирование склада под заказчика.
- Сертификаты соответствия на поставляемую продукцию (по желанию клиента).
- Тестирование поставляемой продукции.
- Поставку компонентов, требующих военную и космическую приемку.
- Входной контроль качества.
- Наличие сертификата ISO.

В составе нашей компании организован Конструкторский отдел, призванный помогать разработчикам, и инженерам.

Конструкторский отдел помогает осуществить:

- Регистрацию проекта у производителя компонентов.
- Техническую поддержку проекта.
- Защиту от снятия компонента с производства.
- Оценку стоимости проекта по компонентам.
- Изготовление тестовой платы монтаж и пусконаладочные работы.



Тел: +7 (812) 336 43 04 (многоканальный)

Email: [org@lifeelectronics.ru](mailto:org@lifeelectronics.ru)