

CPA1D1E025F

25 W, 13.75 - 14.5 GHz, 40 V, Ku-Band GaN MMIC, Power Amplifier

Cree's CPA1D1E025F is a gallium nitride (GaN) High Electron Mobility Transistor (HEMT) based monolithic microwave integrated circuit (MMIC) on a silicon carbide substrate, using a 0.25 μm gate length fabrication process. The Ku Band 25W MMIC is targeted for commercial Ku Band applications. It offers high gain and superior efficiency while meets OQPSK linearity required for Satcom applications at 3dB backed off Psat operations. This Ku Band MMIC is available in a 10 lead, 25 mm x 9.9 mm metal/ceramic flanged package.

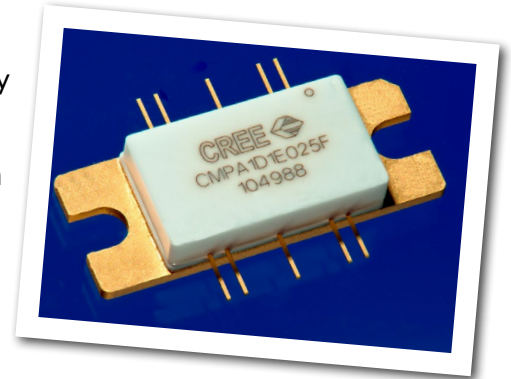

Typical Performance Over 13.75-14.5 GHz ($T_c = 25^\circ\text{C}$)

Parameter	13.75 GHz	14.0 GHz	14.25 GHz	14.5 GHz	Units
Small Signal Gain	26	27	27	26	dB
Linear Output Power	19	19	20	18	W
Power Gain	19.5	18.6	17.1	16.7	dB
Power Added Efficiency	18	18	17	16	%

Note¹: Measured at -30 dBc, 1.6 MHz from carrier, in the CPA1D1E025F-TB under OQPSK modulation, 1.6 Msps, PN23, Alpha Filter = 0.2.

Features

- 26 dB Small Signal Gain
- 40 W Typical Pulsed P_{SAT}
- Operation up to 40 V
- $P_{AVE} = 42$ dBm, linear power under OQPSK
- Class A/B high gain, high efficiency 50 ohm MMIC Ku Band high power amplifier

Applications

- Satellite Communications Uplink

Absolute Maximum Ratings (not simultaneous)

Parameter	Symbol	Rating	Units	Conditions
Drain-source Voltage	V_{DSS}	84	V_{DC}	25°C
Gate-source Voltage	V_{GS}	-10, +2	V_{DC}	25°C
Power Dissipation	P_{DISS}	94	W	
Storage Temperature	T_{STG}	-55, +150	°C	
Operating Junction Temperature	T_J	225	°C	
Maximum Forward Gate Current	I_{GMAX}	10	mA	25°C
Soldering Temperature ¹	T_S	245	°C	
Screw Torque	τ	40	in-oz	
Thermal Resistance, Junction to Case	$R_{\theta JC}$	1.5	°C/W	$P_{DISS} = 94 \text{ W}, 85^\circ\text{C}$
Case Operating Temperature	T_C	-40, +85	°C	CW, $P_{DISS} = 94 \text{ W}$

Note:

¹ Refer to the Application Note on soldering at www.cree.com/products/wireless_appnotes.asp

Electrical Characteristics (Frequency = 13.75 GHz to 14.5 GHz unless otherwise stated; $T_C = 25^\circ\text{C}$)

Characteristics	Symbol	Min.	Typ.	Max.	Units	Conditions
DC Characteristics¹						
Gate Threshold	$V_{GS(TH)}$	-3.8	-3.0	-2.3	V	$V_{DS} = 10 \text{ V}, I_D = 18.2 \text{ mA}$
Gate Quiescent Voltage	V_Q	-	-2.7	-	V	$V_{DS} = 40 \text{ V}, I_D = 240 \text{ mA}$
Saturated Drain Current ²	I_{DS}	14.6	16.4	-	A	$V_{DS} = 6.0 \text{ V}, V_{GS} = 2.0 \text{ V}$
Drain-Source Breakdown Voltage	V_{BD}	84	100	-	V	$V_{GS} = -8 \text{ V}, I_D = 18.2 \text{ mA}$
RF Characteristics³						
Small Signal Gain	S21	-	26	-	dB	$V_{DD} = 40 \text{ V}, I_{DQ} = 240 \text{ mA}, P_{IN} = -20 \text{ dBm}$
Input Return Loss	S11	-	-8	-	dB	$V_{DD} = 40 \text{ V}, I_{DQ} = 240 \text{ mA}, P_{IN} = -20 \text{ dBm}$
Output Return Loss	S22	-	-10	-	dB	$V_{DD} = 40 \text{ V}, I_{DQ} = 240 \text{ mA}, P_{IN} = -20 \text{ dBm}$
Output Mismatch Stress	VSWR	-	-	5:1	Ψ	No damage at all phase angles, $V_{DD} = 40 \text{ V}, I_{DQ} = 240 \text{ mA}, P_{OUT} = 41 \text{ dBm OQPSK}$

Notes:

¹ Measured on-wafer prior to packaging.

² Scaled from PCM data.

³ Measured in the CMPA1D1E025F-TB.

Electrical Characteristics Continued... ($T_c = 25^\circ\text{C}$)

Characteristics	Symbol	Min.	Typ.	Max.	Units	Conditions
RF Characteristics^{1,2,3,4}						
Power Added Efficiency	PAE1	-	16.0	-	%	$V_{DD} = 40\text{ V}$, $I_{DQ} = 240\text{ mA}$, Frequency = 13.75 GHz
Power Added Efficiency	PAE2	-	14.0	-	%	$V_{DD} = 40\text{ V}$, $I_{DQ} = 240\text{ mA}$, Frequency = 14.5 GHz
Power Gain	G_{p1}	-	21.5	-	dB	$V_{DD} = 40\text{ V}$, $I_{DQ} = 240\text{ mA}$, Frequency = 13.75 GHz
Power Gain	G_{p2}	-	19.0	-	dB	$V_{DD} = 40\text{ V}$, $I_{DQ} = 240\text{ mA}$, Frequency = 14.5 GHz
OQPSK Linearity	ACLR1	-	-38	-	dBc	$V_{DD} = 40\text{ V}$, $I_{DQ} = 240\text{ mA}$, Frequency = 13.75 GHz
OQPSK Linearity	ACLR2	-	-37	-	dBc	$V_{DD} = 40\text{ V}$, $I_{DQ} = 240\text{ mA}$, Frequency = 14.5 GHz

Notes:

- ¹ Measured in the CMPA1D1E025F-TB.
- ² Under OQPSK modulated signal, 1.6 Msps, PN23, Alpha Filter = 0.2.
- ³ Measured at $P_{AVE} = 41\text{ dBm}$.
- ⁴ Fixture loss de-embedded.

Electrostatic Discharge (ESD) Classifications

Parameter	Symbol	Class	Test Methodology
Human Body Model	HBM	1A (> 250 V)	JEDEC JESD22 A114-D
Charge Device Model	CDM	II (200 < 500 V)	JEDEC JESD22 C101-C

Typical Performance

**Figure 1. - Small Signal S-parameters
CMPA1D1E025F in Test Fixture**
 $V_{DD} = 40V, I_{DQ} = 240\text{ mA}, T_{case} = 25^{\circ}C$

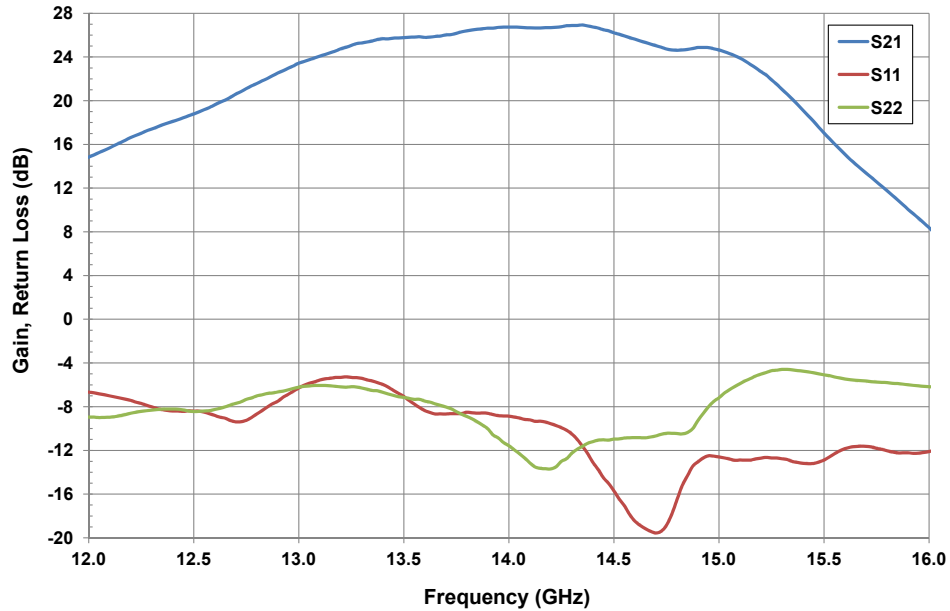
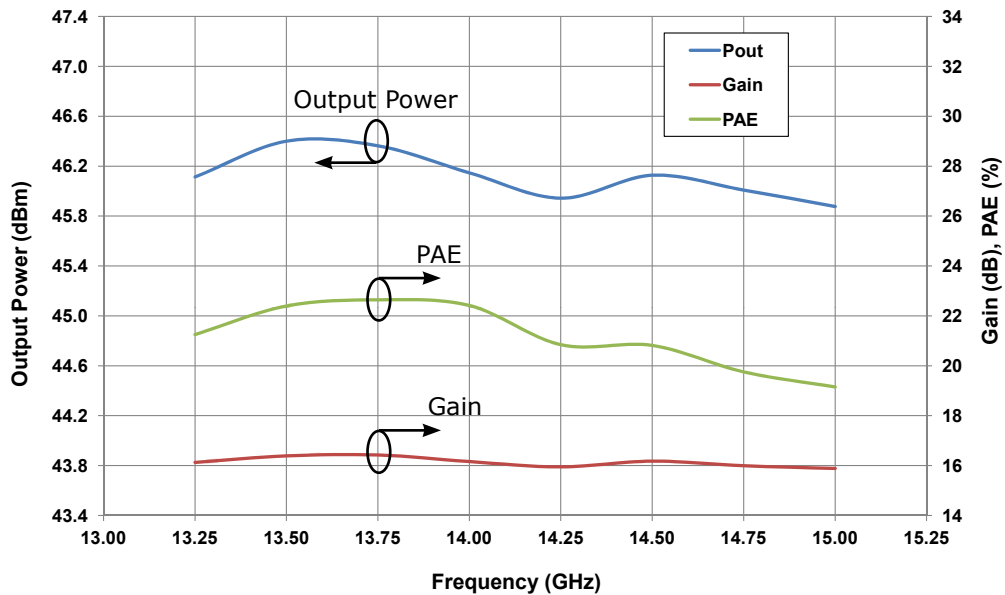
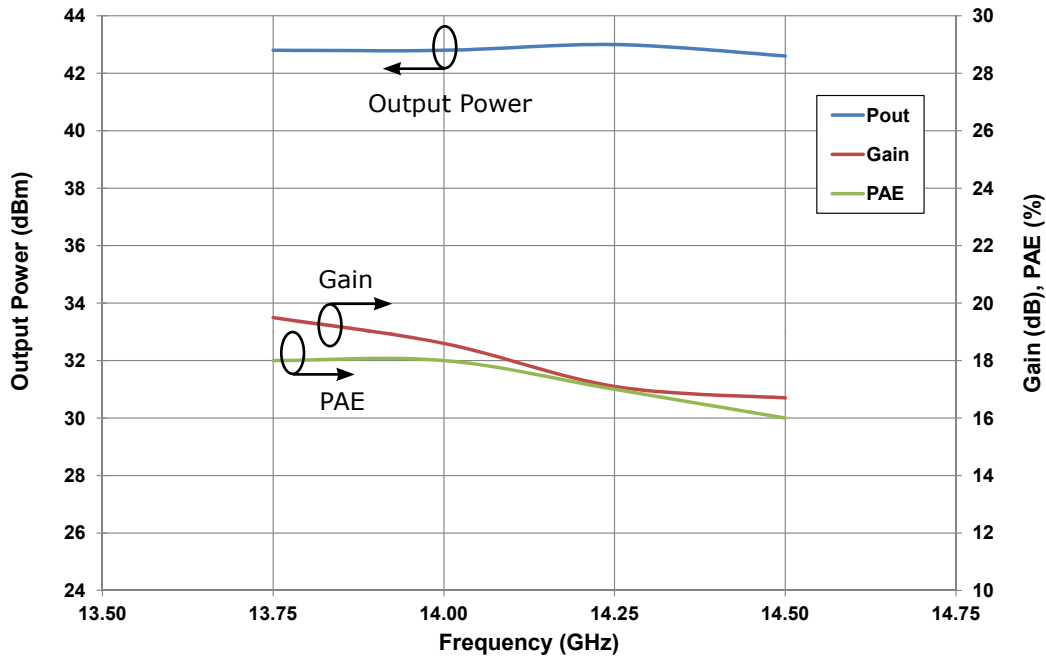

Figure 2. - CMPA1D1E025F Pulsed @ $P_{IN} = 30\text{ dBm}$
10% duty, 100 μ s pulse width
 $V_{DD} = 40\text{ V}, I_{DQ} = 240\text{ mA}, T_{case} = 25^{\circ}C$



Typical Performance

**Figure 3. - CMPA1D1E025F Modulated @ Spectral Regrowth = -30dBc, 1.6 MHz from Carrier
1.6 Msps OQPSK Modulation
 $V_{DD} = 40V, I_{DQ} = 240\text{ mA}, T_{case} = 25^{\circ}C$**



**Figure 4. - CMPA1D1E025F Modulated Power Sweep
1.6 Msps OQPSK Modulation
 $V_{DD} = 40\text{ V}, I_{DQ} = 240\text{ mA}, T_{case} = 25^{\circ}C$**

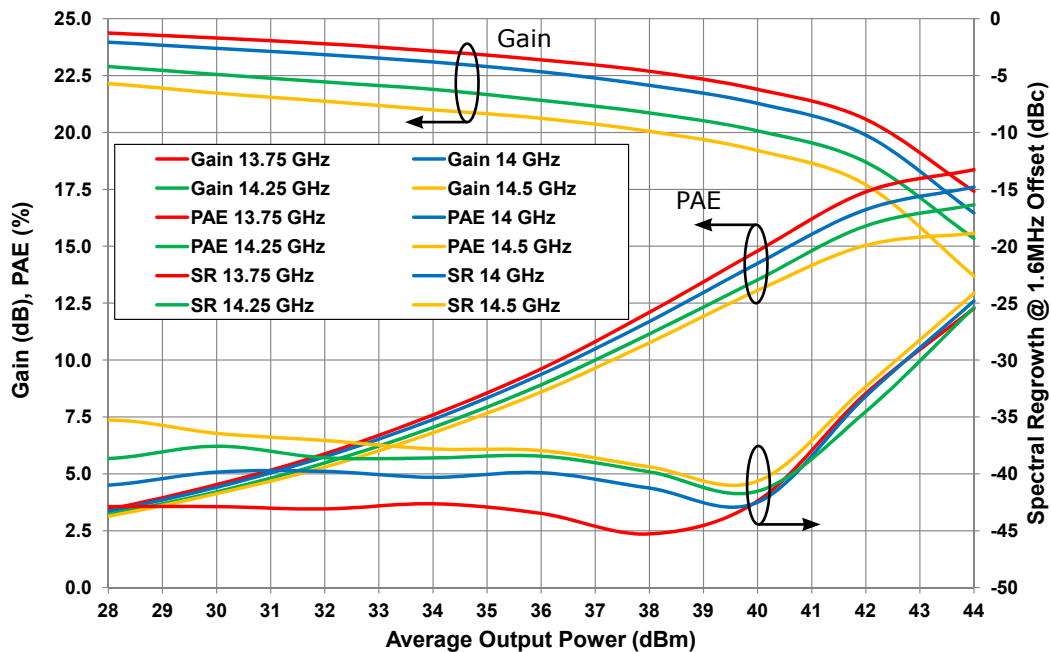

Typical Performance

Figure 5. - CMPA1D1E025F Modulated Power Sweep
1.6 Msps OQPSK Modulation
 $V_{DD} = 40\text{ V}$, $I_{DQ} = 240\text{ mA}$, $T_{case} = 25^\circ\text{C}$

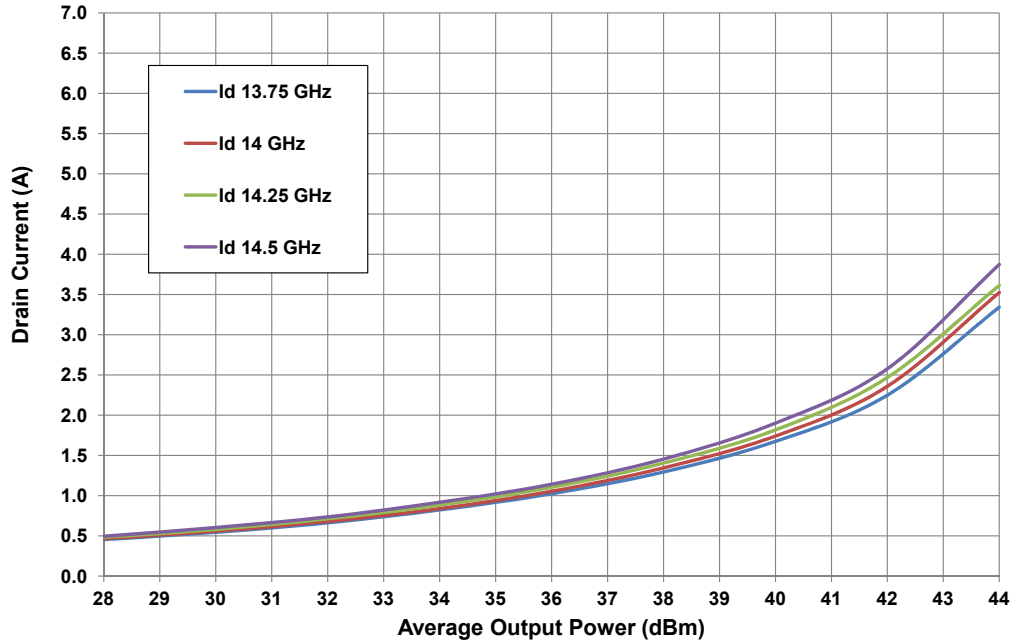
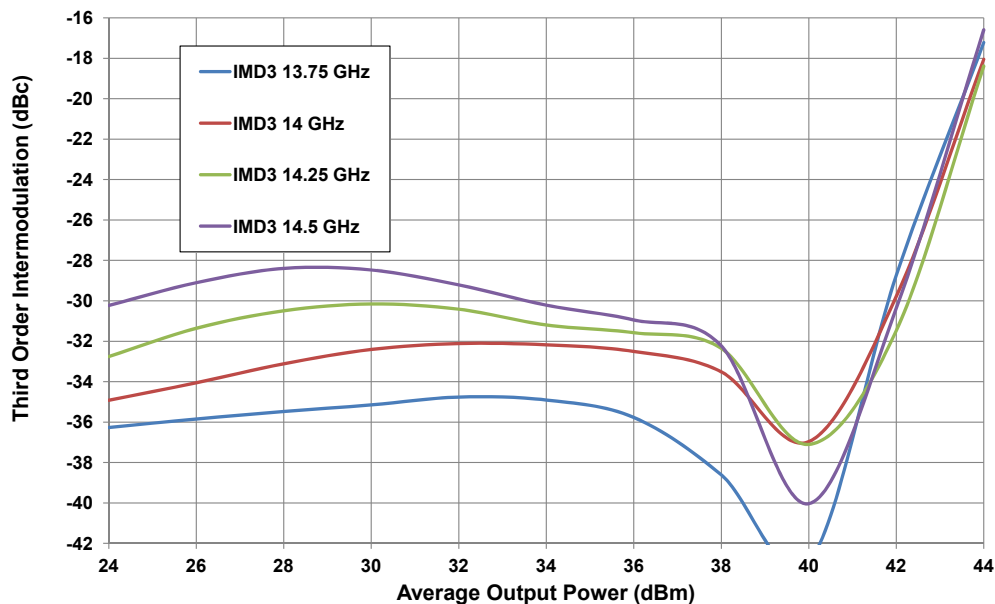

Figure 6. - CMPA1D1E025F Two Tone Power Sweep
IMD3 @ 1 MHz Carrier Spacing
 $V_{DD} = 40\text{ V}$, $I_{DQ} = 240\text{ mA}$, $T_{case} = 25^\circ\text{C}$



Typical Performance

Figure 7. - CMPA1D1E025F AM-AM
 $V_{DD} = 40\text{ V}$, $I_{DQ} = 240\text{ mA}$, $T_{case} = 25^\circ\text{C}$

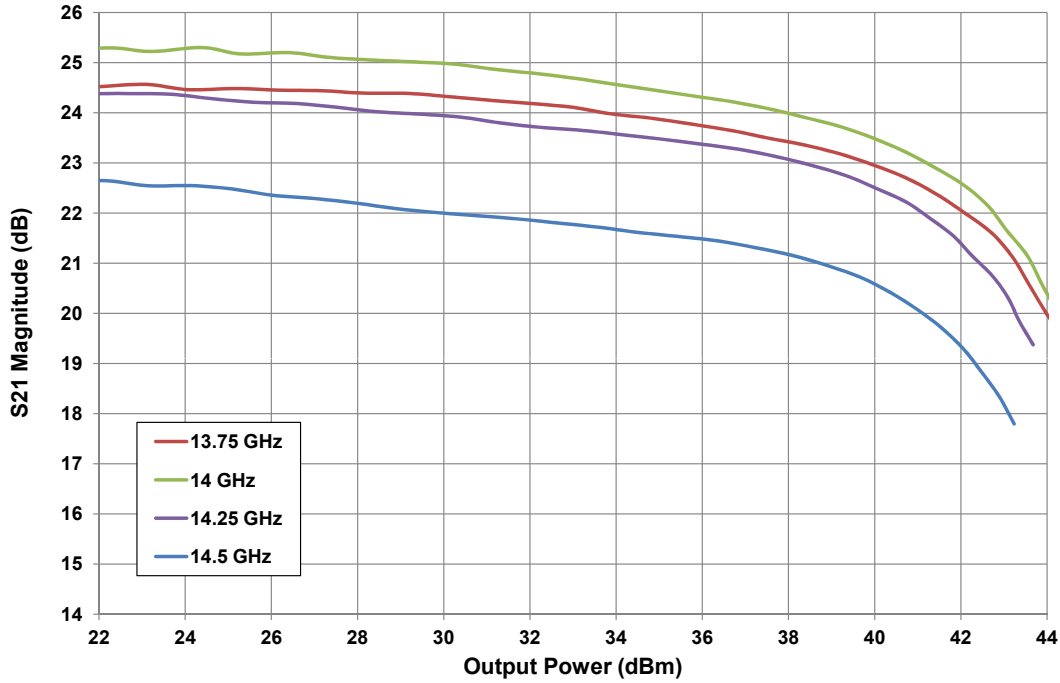
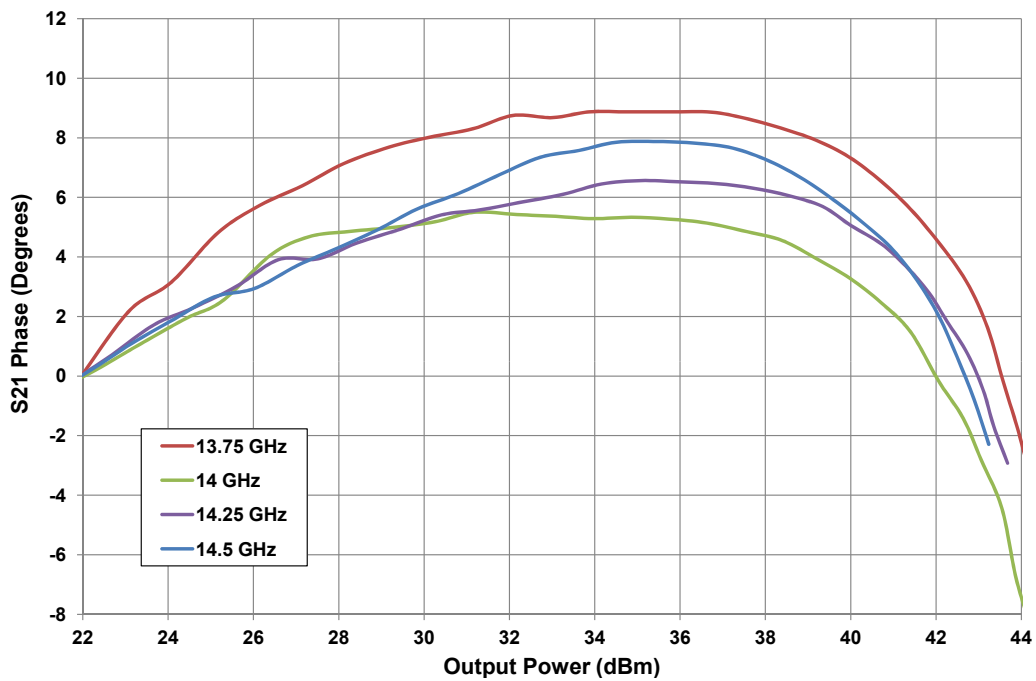
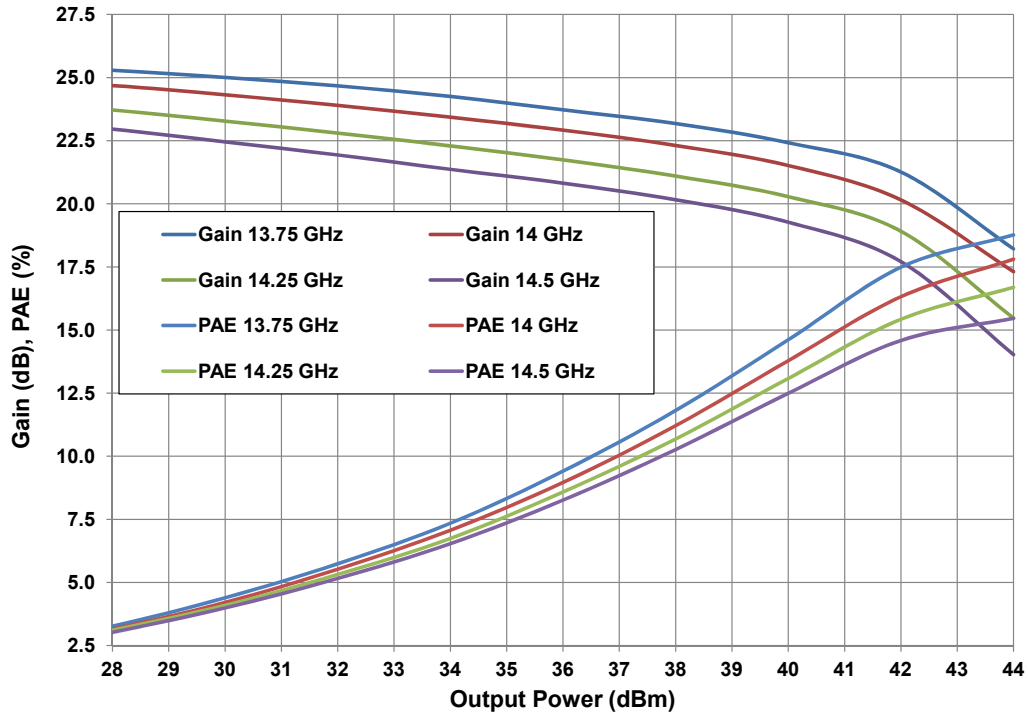

Figure 8. - CMPA1D1E025F AM-PM
 $V_{DD} = 40\text{ V}$, $I_{DQ} = 240\text{ mA}$, $T_{case} = 25^\circ\text{C}$



Typical Performance

Figure 9. - CMPA1D1E025F Gain and Power Added Efficiency vs CW Output Power
 $V_{DD} = 40\text{ V}$, $I_{DO} = 240\text{ mA}$, $T_{case} = 25^\circ\text{C}$



CMPA1D1E025F Power Dissipation De-rating Curve

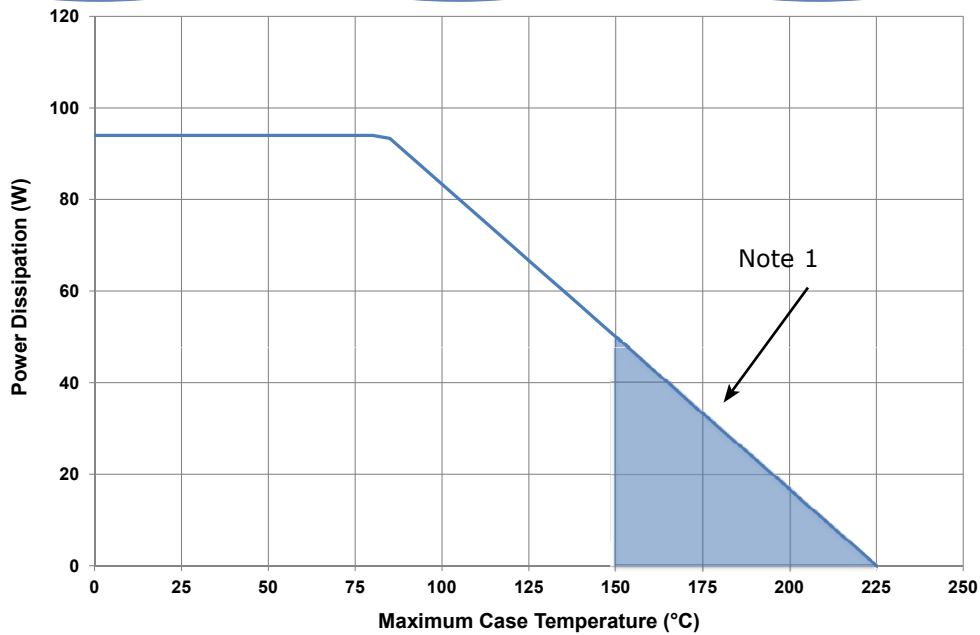

Note 1. Area exceeds Maximum Case Temperature (See Page 2).

CPMA1D1E025F-TB Demonstration Amplifier Circuit Bill of Materials

Designator	Description	Qty
C5	CAP ELECT 100UF 80V AFK SMD	1
C1,C2	CAP, 33000PF, 0805,100V, X7R	2
C3,C4	CAP, 2.2UF, 100V, 10%, X7R, 1210	4
J1,J2	CONN, SMA, PANEL MOUNT JACK, FLANGE, 4-HOLE, BLUNT POST, 20MIL	2
J4	CONN, SMB, STRAIGHT JACK RECEPTACLE, SMT, 50 OHM, Au PLATED	1
J3	HEADER RT>PLZ .1CEN LK 9POS	1
W1	WIRE, BLACK, 22 AWG ~ 1.50"	1
W2	WIRE, BLACK, 22 AWG ~ 1.75"	1
W3	WIRE, BLACK, 22 AWG ~ 2.0"	1
	PCB, TEST FIXTURE, TACONICS RF35P, 20 MILS, 440208 PKG	1
	2-56 SOC HD SCREW 1/4 SS	4
-	#2 SPLIT LOCKWASHER SS	4
Q1	CPMA1D1E025F	1

CPMA1D1E025F-TB Demonstration Amplifier Circuit

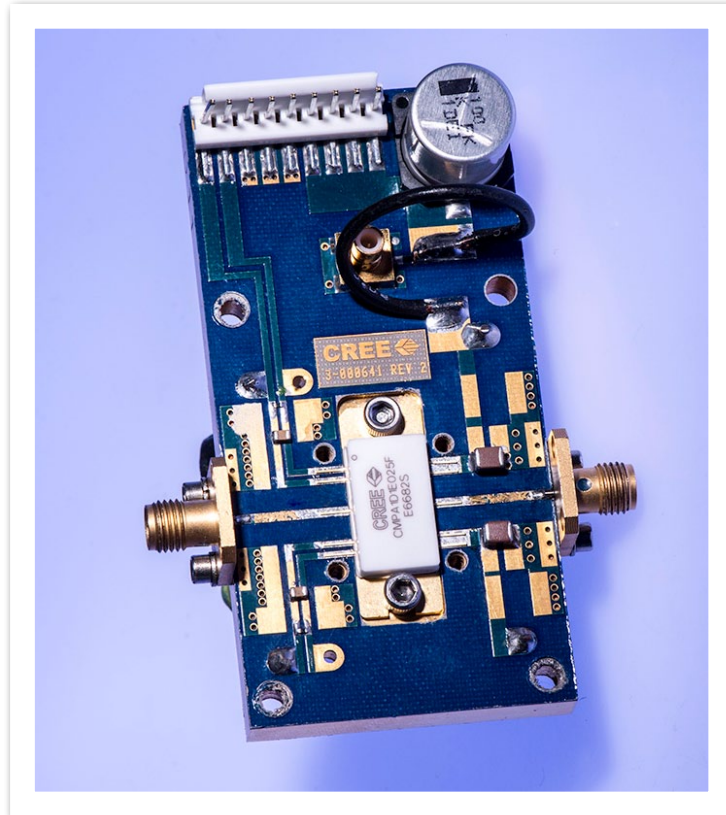

CMPA1D1E025F-TB Demonstration Amplifier Circuit Schematic

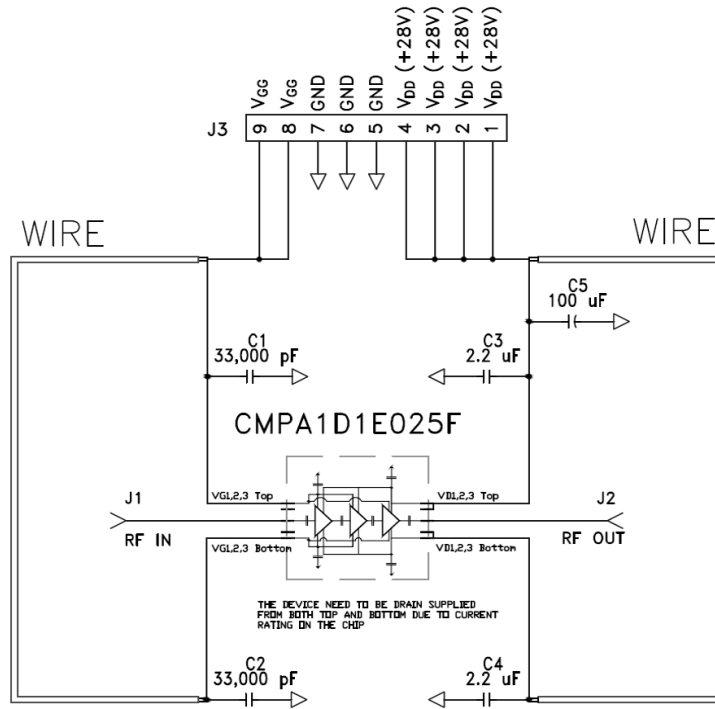

CMPA1D1E025F-TB Demonstration Amplifier Circuit Outline

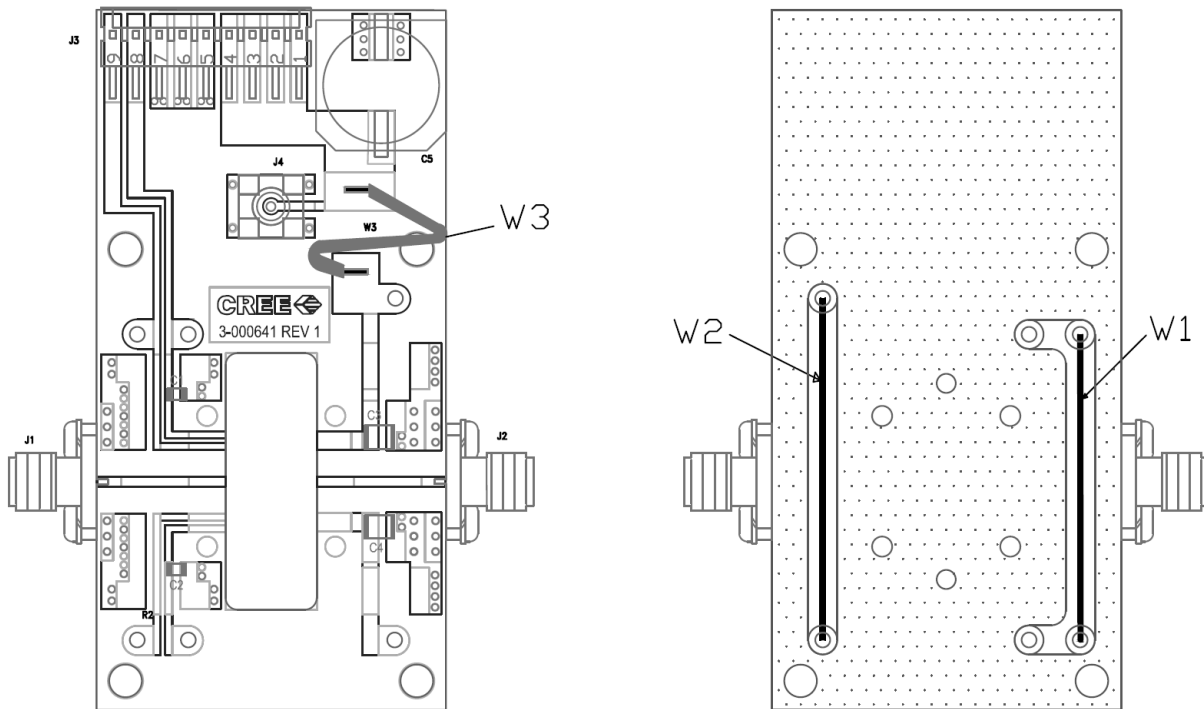

Product Dimensions CMPA1D1E025F (Package Type — 440208)

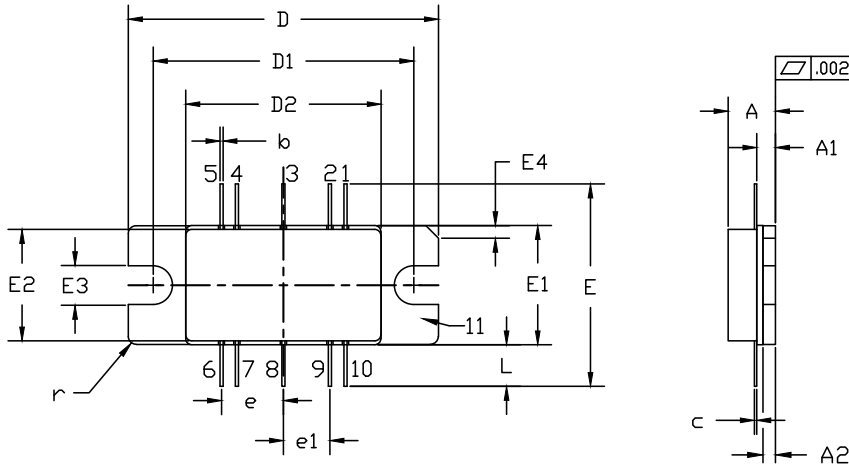

NOTES:

1. DIMENSIONING AND TOLERANCING PER ANSI Y14.5M - 1994.
2. CONTROLLING DIMENSION: INCH.
3. ADHESIVE FROM LID MAY EXTEND A MAXIMUM OF 0.020" BEYOND EDGE OF LID.
4. LID MAY BE MISALIGNED TO THE BODY OF PACKAGE BY A MAXIMUM OF 0.008" IN ANY DIRECTION.

DIM	INCHES		MILLIMETERS		NOTES
	MIN	MAX	MIN	MAX	
A	0.148	0.168	3.76	4.27	
A1	0.055	0.065	1.40	1.65	
A2	0.035	0.045	0.89	1.14	
b	0.01	TYP	0.254	TYP	10x
c	0.007	0.009	0.18	0.23	
D	0.995	1.005	25.27	25.53	
D1	0.835	0.845	21.21	21.46	
D2	0.623	0.637	15.82	16.18	
E	0.653	TYP	16.59	TYP	
E1	0.380	0.390	9.65	9.91	
E2	0.355	0.365	9.02	9.27	
E3	0.120	0.130	3.05	3.30	
E4	0.035	0.045	0.89	1.14	45° CHAMFER
e	0.200	TYP	5.08	TYP	4x
e1	0.150	TYP	3.81	TYP	4x
L	0.115	0.155	2.92	3.94	10x
r	0.025	TYP	.635	TYP	3x

PIN 1: GATE BIAS 6: DRAIN BIAS
 2: GATE BIAS 7: DRAIN BIAS
 3: RF IN 8: RF OUT
 4: GATE BIAS 9: DRAIN BIAS
 5: GATE BIAS 10: DRAIN BIAS
 11: SOURCE

Pin Number	Qty
1	Gate Bias
2	NC
3	RF In
4	NC
5	Gate Bias
6	Drain Bias
7	Drain Bias
8	RF Out
9	Drain Bias
10	Drain Bias
11	Source

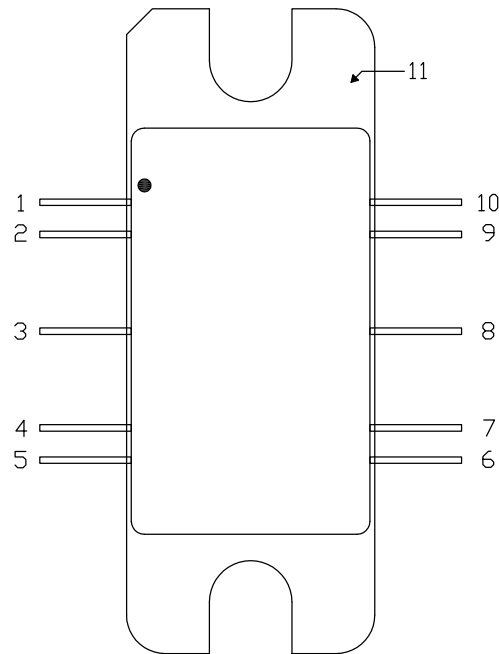

Part Number System

CMPA1D1E025F

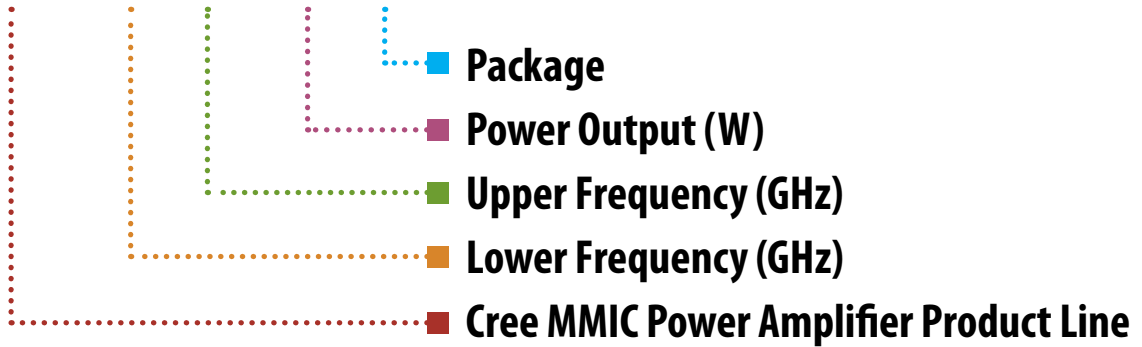

Parameter	Value	Units
Lower Frequency	13.5	GHz
Upper Frequency ¹	14.5	GHz
Power Output	25	W
Package	Flange	-

Table 1.

Note¹: Alpha characters used in frequency code indicate a value greater than 9.9 GHz. See Table 2 for value.

Character Code	Code Value
A	0
B	1
C	2
D	3
E	4
F	5
G	6
H	7
J	8
K	9
Examples:	1A = 10.0 GHz 2H = 27.0 GHz

Table 2.



Disclaimer

Specifications are subject to change without notice. Cree, Inc. believes the information contained within this data sheet to be accurate and reliable. However, no responsibility is assumed by Cree for its use or for any infringement of patents or other rights of third parties which may result from its use. No license is granted by implication or otherwise under any patent or patent rights of Cree. Cree makes no warranty, representation or guarantee regarding the suitability of its products for any particular purpose. "Typical" parameters are the average values expected by Cree in large quantities and are provided for information purposes only. These values can and do vary in different applications, and actual performance can vary over time. All operating parameters should be validated by customer's technical experts for each application. Cree products are not designed, intended, or authorized for use as components in applications intended for surgical implant into the body or to support or sustain life, in applications in which the failure of the Cree product could result in personal injury or death, or in applications for the planning, construction, maintenance or direct operation of a nuclear facility. CREE and the CREE logo are registered trademarks of Cree, Inc.

For more information, please contact:

Cree, Inc.
4600 Silicon Drive
Durham, North Carolina, USA 27703
www.cree.com/RF

Sarah Miller
Marketing & Export
Cree, RF Components
1.919.407.5302

Ryan Baker
Marketing
Cree, RF Components
1.919.407.7816

Tom Dekker
Sales Director
Cree, RF Components
1.919.407.5639

Компания «Life Electronics» занимается поставками электронных компонентов импортного и отечественного производства от производителей и со складов крупных дистрибьюторов Европы, Америки и Азии.

С конца 2013 года компания активно расширяет линейку поставок компонентов по направлению коаксиальный кабель, кварцевые генераторы и конденсаторы (керамические, пленочные, электролитические), за счёт заключения дистрибьюторских договоров

Мы предлагаем:

- Конкурентоспособные цены и скидки постоянным клиентам.
- Специальные условия для постоянных клиентов.
- Подбор аналогов.
- Поставку компонентов в любых объемах, удовлетворяющих вашим потребностям.
- Приемлемые сроки поставки, возможна ускоренная поставка.
- Доставку товара в любую точку России и стран СНГ.
- Комплексную поставку.
- Работу по проектам и поставку образцов.
- Формирование склада под заказчика.
- Сертификаты соответствия на поставляемую продукцию (по желанию клиента).
- Тестирование поставляемой продукции.
- Поставку компонентов, требующих военную и космическую приемку.
- Входной контроль качества.
- Наличие сертификата ISO.

В составе нашей компании организован Конструкторский отдел, призванный помогать разработчикам, и инженерам.

Конструкторский отдел помогает осуществить:

- Регистрацию проекта у производителя компонентов.
- Техническую поддержку проекта.
- Защиту от снятия компонента с производства.
- Оценку стоимости проекта по компонентам.
- Изготовление тестовой платы монтаж и пусконаладочные работы.



Тел: +7 (812) 336 43 04 (многоканальный)

Email: org@lifeelectronics.ru