

AD8051/AD8052/AD8054

FEATURES

High speed and fast settling on 5 V

110 MHz, -3 dB bandwidth ($G = +1$) (AD8051/AD8052)

150 MHz, -3 dB bandwidth ($G = +1$) (AD8054)

145 V/ μ s slew rate

50 ns settling time to 0.1%

Single-supply operation

Output swings to within 25 mV of either rail

Input voltage range: -0.2 V to +4 V; $V_S = 5$ V

Video specifications ($G = +2$)

0.1 dB gain flatness: 20 MHz; $R_L = 150 \Omega$

Differential gain/phase: 0.03%/0.03°

Low distortion

-80 dBc total harmonic @ 1 MHz, $R_L = 100 \Omega$

Outstanding load drive capability

Drives 45 mA, 0.5 V from supply rails (AD8051/AD8052)

Drives 50 pF capacitive load ($G = +1$) (AD8051/AD8052)

Low power: 2.75 mA/amplifier (AD8054)

Low power: 4.4 mA/amplifier (AD8051/AD8052)

APPLICATIONS

Active filters

Analog-to-digital drivers

Clock buffer

Consumer video

Professional cameras

CCD imaging systems

CD/DVD ROMs

GENERAL DESCRIPTION

The AD8051 (single), AD8052 (dual), and AD8054 (quad) are low cost, high speed, voltage feedback amplifiers. The amplifiers operate on +3 V, +5 V, or ± 5 V supplies at low supply current. They have true single-supply capability with an input voltage range extending 200 mV below the negative rail and within 1 V of the positive rail.

Despite their low cost, the AD8051/AD8052/AD8054 provide excellent overall performance and versatility. The output voltage swings to within 25 mV of each rail, providing maximum output dynamic range with excellent overdrive recovery.

Rev. J

Information furnished by Analog Devices is believed to be accurate and reliable. However, no responsibility is assumed by Analog Devices for its use, nor for any infringements of patents or other rights of third parties that may result from its use. Specifications subject to change without notice. No license is granted by implication or otherwise under any patent or patent rights of Analog Devices. Trademarks and registered trademarks are the property of their respective owners.

PIN CONNECTIONS (TOP VIEWS)

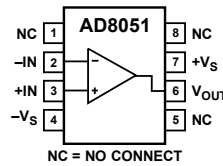

Figure 1. SOIC-8 (R)

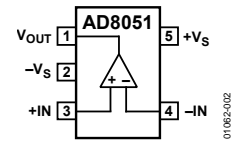

Figure 2. SOT-23-5 (RJ)



Figure 3. SOIC (R-8) and MSOP (RM-8)



Figure 4. SOIC (R-14) and TSSOP (RU-14)



Figure 5. Low Distortion Rail-to-Rail Output Swing

The AD8051/AD8052/AD8054 are well suited for video electronics, cameras, video switchers, or any high speed portable equipment. Low distortion and fast settling make them ideal for active filter applications.

The AD8051/AD8052 in the 8-lead SOIC, the AD8052 in the MSOP, the AD8054 in the 14-lead SOIC, and the 14-lead TSSOP packages are available in the extended temperature range of -40°C to +125°C.

TABLE OF CONTENTS

| | |
|---|----|
| Features | 1 |
| Applications..... | 1 |
| Pin Connections (Top Views)..... | 1 |
| General Description | 1 |
| Revision History | 2 |
| Specifications..... | 3 |
| Absolute Maximum Ratings..... | 9 |
| Thermal Resistance | 9 |
| Maximum Power Dissipation | 9 |
| ESD Caution..... | 9 |
| Typical Performance Characteristics | 10 |
| Theory of Operation | 16 |

REVISION HISTORY

7/09—Rev. I to Rev. J

| | |
|---------------------------|----|
| Changes to Figure 22..... | 12 |
|---------------------------|----|

12/08—Rev. H to Rev. I

| | |
|---|----|
| Change to Settling Time to 0.1% Parameter, Table 1..... | 3 |
| Updated Outline Dimensions | 20 |

12/07—Rev. G to Rev. H

| | |
|----------------------------------|----|
| Changes to Applications | 1 |
| Updated Outline Dimensions | 21 |
| Changes to Ordering Guide | 23 |

5/06—Rev. F to Rev. G

| | |
|--|-----------|
| Updated Format..... | Universal |
| Changes to Features, Applications, and General Description | 1 |
| Changes to Figure 15..... | 12 |
| Changes to the Ordering Guide..... | 22 |

9/04—Rev. E to Rev. F

| | |
|---------------------------------|----|
| Changes to Ordering Guide | 7 |
| Changes to Figure 15..... | 15 |

3/04—Rev. D to Rev. E

| | |
|--------------------------------------|---|
| Changes to General Description | 2 |
| Changes to Specifications | 3 |
| Changes to Ordering Guide | 6 |

| | |
|---|----|
| Circuit Description | 16 |
| Application Information..... | 17 |
| Overdrive Recovery | 17 |
| Driving Capacitive Loads..... | 17 |
| Layout Considerations..... | 18 |
| Active Filters | 18 |
| Analog-to-Digital and Digital-to-Analog Applications..... | 19 |
| Sync Stripper | 20 |
| Single-Supply Composite Video Line Driver | 20 |
| Outline Dimensions | 21 |
| Ordering Guide | 23 |

2/03—Rev. C to Rev. D

| | |
|--|---|
| Changes to General Description | 1 |
| Changes to Specifications..... | 3 |
| Changes to Absolute Maximum Ratings..... | 6 |

1/03—Rev. B to Rev. C

| | |
|--|----|
| Changes to General Description | 1 |
| Changes to Pin Connections..... | 1 |
| Changes to Specifications..... | 2 |
| Changes to Absolute Maximum Ratings..... | 9 |
| Changes to Figure 2..... | 9 |
| Changes to Ordering Guide | 9 |
| Updated Outline Dimensions | 20 |

SPECIFICATIONS

@ $T_A = 25^\circ\text{C}$, $V_S = 5\text{ V}$, $R_L = 2\text{ k}\Omega$ to 2.5 V , unless otherwise noted.

Table 1.

| Parameter | Conditions | AD8051A/AD8052A | | | AD8054A | | | Unit |
|--|--|-----------------|---------------|------|---------|---------------|-----|------------------------------|
| | | Min | Typ | Max | Min | Typ | Max | |
| DYNAMIC PERFORMANCE | | | | | | | | |
| -3 dB Small Signal Bandwidth | $G = +1$, $V_{OUT} = 0.2\text{ V p-p}$ | 70 | 110 | | 80 | 150 | | MHz |
| | $G = -1, +2$, $V_{OUT} = 0.2\text{ V p-p}$ | | 50 | | | 60 | | MHz |
| Bandwidth for 0.1 dB Flatness | $G = +2$, $V_{OUT} = 0.2\text{ V p-p}$, $R_L = 150\ \Omega$ to 2.5 V | | | | | | | MHz |
| | $R_F = 806\ \Omega$ (AD8051A/ AD8052A) | | 20 | | | | | MHz |
| | $R_F = 200\ \Omega$ (AD8054A) | | | | | 12 | | MHz |
| Slew Rate | $G = -1$, $V_{OUT} = 2\text{ V step}$ | 100 | 145 | | 140 | 170 | | V/ μs |
| Full Power Response | $G = +1$, $V_{OUT} = 2\text{ V p-p}$ | | 35 | | | 45 | | MHz |
| Settling Time to 0.1% | $G = -1$, $V_{OUT} = 2\text{ V step}$ | | 50 | | | 40 | | ns |
| NOISE/DISTORTION PERFORMANCE | | | | | | | | |
| Total Harmonic Distortion ¹ | $f_C = 5\text{ MHz}$, $V_{OUT} = 2\text{ V p-p}$, $G = +2$ | | -67 | | | -68 | | dB |
| Input Voltage Noise | $f = 10\text{ kHz}$ | | 16 | | | 16 | | nV/ $\sqrt{\text{Hz}}$ |
| Input Current Noise | $f = 10\text{ kHz}$ | | 850 | | | 850 | | fA/ $\sqrt{\text{Hz}}$ |
| Differential Gain Error (NTSC) | $G = +2$, $R_L = 150\ \Omega$ to 2.5 V | | 0.09 | | | 0.07 | | % |
| | $R_L = 1\text{ k}\Omega$ to 2.5 V | | 0.03 | | | 0.02 | | % |
| Differential Phase Error (NTSC) | $G = +2$, $R_L = 150\ \Omega$ to 2.5 V | | 0.19 | | | 0.26 | | Degrees |
| | $R_L = 1\text{ k}\Omega$ to 2.5 V | | 0.03 | | | 0.05 | | Degrees |
| Crosstalk | $f = 5\text{ MHz}$, $G = +2$ | | -60 | | | -60 | | dB |
| DC PERFORMANCE | | | | | | | | |
| Input Offset Voltage | | | 1.7 | 10 | | 1.7 | 12 | mV |
| | $T_{MIN} - T_{MAX}$ | | | 25 | | | 30 | mV |
| Offset Drift | | | 10 | | | 15 | | $\mu\text{V}/^\circ\text{C}$ |
| Input Bias Current | | | 1.4 | 2.5 | | 2 | 4.5 | μA |
| | $T_{MIN} - T_{MAX}$ | | | 3.25 | | | 4.5 | μA |
| Input Offset Current | | | 0.1 | 0.75 | | 0.2 | 1.2 | μA |
| Open-Loop Gain | $R_L = 2\text{ k}\Omega$ to 2.5 V | 86 | 98 | | 82 | 98 | | dB |
| | $T_{MIN} - T_{MAX}$ | | 96 | | | 96 | | dB |
| | $R_L = 150\ \Omega$ to 2.5 V | 76 | 82 | | 74 | 82 | | dB |
| | $T_{MIN} - T_{MAX}$ | | 78 | | | 78 | | dB |
| INPUT CHARACTERISTICS | | | | | | | | |
| Input Resistance | | | 290 | | | 300 | | k Ω |
| Input Capacitance | | | 1.4 | | | 1.5 | | pF |
| Input Common-Mode Voltage Range | | | -0.2 to +4 | | | -0.2 to +4 | | V |
| Common-Mode Rejection Ratio | $V_{CM} = 0\text{ V}$ to 3.5 V | 72 | 88 | | 70 | 86 | | dB |

AD8051/AD8052/AD8054

| Parameter | Conditions | AD8051A/AD8052A | | | AD8054A | | | Unit |
|------------------------------|------------------------------------|-----------------|----------------|------|----------------|---------------|-------|------|
| | | Min | Typ | Max | Min | Typ | Max | |
| OUTPUT CHARACTERISTICS | | | | | | | | |
| Output Voltage Swing | $R_L = 10\text{ k}\Omega$ to 2.5 V | | 0.015 to 4.985 | | | 0.03 to 4.975 | | V |
| | $R_L = 2\text{ k}\Omega$ to 2.5 V | 0.1 to 4.9 | 0.025 to 4.975 | | 0.125 to 4.875 | 0.05 to 4.95 | | V |
| | $R_L = 150\ \Omega$ to 2.5 V | 0.3 to 4.625 | 0.2 to 4.8 | | 0.55 to 4.4 | 0.25 to 4.65 | | V |
| Output Current | $V_{OUT} = 0.5\text{ V}$ to 4.5 V | | 45 | | | 30 | | mA |
| | $T_{MIN} - T_{MAX}$ | | 45 | | | 30 | | mA |
| Short-Circuit Current | Sourcing | | 80 | | | 45 | | mA |
| | Sinking | | 130 | | | 85 | | mA |
| Capacitive Load Drive | $G = +1$ (AD8051/AD8052) | | 50 | | | | | pF |
| | $G = +2$ (AD8054) | | | | | 40 | | pF |
| POWER SUPPLY | | | | | | | | |
| Operating Range | | 3 | | 12 | 3 | | 12 | V |
| Quiescent Current/Amplifier | | | 4.4 | 5 | | 2.75 | 3.275 | mA |
| Power Supply Rejection Ratio | $\Delta V_S = \pm 1\text{ V}$ | 70 | 80 | | 68 | 80 | | dB |
| OPERATING TEMPERATURE RANGE | | | | | | | | |
| | RJ-5 | -40 | | +85 | | | | °C |
| | RM-8, R-8, RU-14, R-14 | -40 | | +125 | -40 | | +125 | °C |

¹ Refer to Figure 19.

@ $T_A = 25^\circ\text{C}$, $V_S = 3\text{ V}$, $R_L = 2\text{ k}\Omega$ to 1.5 V , unless otherwise noted.

Table 2.

| Parameter | Conditions | AD8051A/AD8052A | | | AD8054A | | | Unit |
|--|---|-----------------|---------------|------|---------|---------------|-----|------------------------------|
| | | Min | Typ | Max | Min | Typ | Max | |
| DYNAMIC PERFORMANCE | | | | | | | | |
| -3 dB Small Signal Bandwidth | $G = +1, V_{OUT} = 0.2\text{ V p-p}$ | 70 | 110 | | 80 | 135 | | MHz |
| | $G = -1, +2, V_{OUT} = 0.2\text{ V p-p}$ | | 50 | | | 65 | | MHz |
| Bandwidth for 0.1 dB Flatness | $G = +2, V_{OUT} = 0.2\text{ V p-p}$, $R_L = 150\ \Omega$ to 2.5 V $R_F = 402\ \Omega$ (AD8051A/ AD8052A) $R_F = 200\ \Omega$ (AD8054A) | | 17 | | | 10 | | MHz |
| Slew Rate | $G = -1, V_{OUT} = 2\text{ V step}$ | 90 | 135 | | 110 | 150 | | V/ μs |
| Full Power Response | $G = +1, V_{OUT} = 1\text{ V p-p}$ | | 65 | | | 85 | | MHz |
| Settling Time to 0.1% | $G = -1, V_{OUT} = 2\text{ V step}$ | | 55 | | | 55 | | ns |
| NOISE/DISTORTION PERFORMANCE | | | | | | | | |
| Total Harmonic Distortion ¹ | $f_C = 5\text{ MHz}, V_{OUT} = 2\text{ V p-p}$, $G = -1, R_L = 100\ \Omega$ to 1.5 V | | -47 | | | -48 | | dB |
| Input Voltage Noise | $f = 10\text{ kHz}$ | | 16 | | | 16 | | nV/ $\sqrt{\text{Hz}}$ |
| Input Current Noise | $f = 10\text{ kHz}$ | | 600 | | | 600 | | fA/ $\sqrt{\text{Hz}}$ |
| Differential Gain Error (NTSC) | $G = +2, V_{CM} = 1\text{ V}$ $R_L = 150\ \Omega$ to 1.5 V | | 0.11 | | | 0.13 | | % |
| | $R_L = 1\text{ k}\Omega$ to 1.5 V | | 0.09 | | | 0.09 | | % |
| Differential Phase Error (NTSC) | $G = +2, V_{CM} = 1\text{ V}$ $R_L = 150\ \Omega$ to 1.5 V | | 0.24 | | | 0.3 | | Degrees |
| | $R_L = 1\text{ k}\Omega$ to 1.5 V | | 0.10 | | | 0.1 | | Degrees |
| Crosstalk | $f = 5\text{ MHz}, G = +2$ | | -60 | | | -60 | | dB |
| DC PERFORMANCE | | | | | | | | |
| Input Offset Voltage | | | 1.6 | 10 | | 1.6 | 12 | mV |
| | $T_{MIN} - T_{MAX}$ | | | 25 | | | 30 | mV |
| Offset Drift | | | 10 | | | 15 | | $\mu\text{V}/^\circ\text{C}$ |
| Input Bias Current | | | 1.3 | 2.6 | | 2 | 4.5 | μA |
| | $T_{MIN} - T_{MAX}$ | | | 3.25 | | | 4.5 | μA |
| Input Offset Current | | | 0.15 | 0.8 | | 0.2 | 1.2 | μA |
| Open-Loop Gain | $R_L = 2\text{ k}\Omega$ | 80 | 96 | | 80 | 96 | | dB |
| | $T_{MIN} - T_{MAX}$ | | 94 | | | 94 | | dB |
| | $R_L = 150\ \Omega$ | 74 | 82 | | 72 | 80 | | dB |
| | $T_{MIN} - T_{MAX}$ | | 76 | | | 76 | | dB |
| INPUT CHARACTERISTICS | | | | | | | | |
| Input Resistance | | | 290 | | | 300 | | k Ω |
| Input Capacitance | | | 1.4 | | | 1.5 | | pF |
| Input Common-Mode Voltage Range | | | -0.2 to +2 | | | -0.2 to +2 | | V |
| Common-Mode Rejection Ratio | $V_{CM} = 0\text{ V to }1.5\text{ V}$ | 72 | 88 | | 70 | 86 | | dB |

AD8051/AD8052/AD8054

| Parameter | Conditions | AD8051A/AD8052A | | | AD8054A | | | Unit |
|------------------------------|------------------------------------|-----------------|-------------------|------|-----------------|------------------|-------|------|
| | | Min | Typ | Max | Min | Typ | Max | |
| OUTPUT CHARACTERISTICS | | | | | | | | |
| Output Voltage Swing | $R_L = 10\text{ k}\Omega$ to 1.5 V | | 0.01 to 2.99 | | | 0.025 to 2.98 | | V |
| | $R_L = 2\text{ k}\Omega$ to 1.5 V | 0.075 to 2.9 | 0.02 to 2.98 | | 0.1 to 2.9 | 0.35 to 2.965 | | V |
| | $R_L = 150\ \Omega$ to 1.5 V | 0.2 to 2.75 | 0.125 to 2.875 | | 0.35 to 2.55 | 0.15 to 2.75 | | V |
| Output Current | $V_{OUT} = 0.5\text{ V}$ to 2.5 V | | 45 | | | 25 | | mA |
| | $T_{MIN} - T_{MAX}$ | | 45 | | | 25 | | mA |
| Short-Circuit Current | Sourcing | | 60 | | | 30 | | mA |
| | Sinking | | 90 | | | 50 | | mA |
| Capacitive Load Drive | $G = +1$ (AD8051/AD8052) | | 45 | | | | | pF |
| | $G = +2$ (AD8054) | | | | | 35 | | pF |
| POWER SUPPLY | | | | | | | | |
| Operating Range | | 3 | | 12 | 3 | | 12 | V |
| Quiescent Current/Amplifier | | | 4.2 | 4.8 | | 2.625 | 3.125 | mA |
| Power Supply Rejection Ratio | $\Delta V_S = 0.5\text{ V}$ | 68 | 80 | | 68 | 80 | | dB |
| OPERATING TEMPERATURE RANGE | | | | | | | | |
| | RJ-5 | -40 | | +85 | | | | °C |
| | RM-8, R-8, RU-14, R-14 | -40 | | +125 | -40 | | +125 | °C |

¹ Refer to Figure 19.

@ $T_A = 25^\circ\text{C}$, $V_S = \pm 5\text{ V}$, $R_L = 2\text{ k}\Omega$ to ground, unless otherwise noted.

Table 3.

| Parameter | Conditions | AD8051A/AD8052A | | | AD8054A | | | Unit |
|-------------------------------------|--|-------------------|-------------------|------|-----------------|-------------------|-----|------------------------------|
| | | Min | Typ | Max | Min | Typ | Max | |
| DYNAMIC PERFORMANCE | | | | | | | | |
| -3 dB Small Signal Bandwidth | $G = +1, V_{OUT} = 0.2\text{ V p-p}$ | 70 | 110 | | 85 | 160 | | MHz |
| | $G = -1, +2, V_{OUT} = 0.2\text{ V p-p}$ | | 50 | | | 65 | | MHz |
| Bandwidth for 0.1 dB Flatness | $G = +2, V_{OUT} = 0.2\text{ V p-p}$, $R_L = 150\ \Omega$, $R_F = 1.1\text{ k}\Omega$ (AD8051A/ AD8052A) $R_F = 200\ \Omega$ (AD8054A) | | 20 | | | 15 | | MHz |
| Slew Rate | $G = -1, V_{OUT} = 2\text{ V step}$ | 105 | 170 | | 150 | 190 | | V/ μs |
| Full Power Response | $G = +1, V_{OUT} = 2\text{ V p-p}$ | | 40 | | | 50 | | MHz |
| Settling Time to 0.1% | $G = -1, V_{OUT} = 2\text{ V step}$ | | 50 | | | 40 | | MHz |
| NOISE/DISTORTION PERFORMANCE | | | | | | | | |
| Total Harmonic Distortion | $f_C = 5\text{ MHz}, V_{OUT} = 2\text{ V p-p}$, $G = +2$ | | -71 | | | -72 | | dB |
| Input Voltage Noise | $f = 10\text{ kHz}$ | | 16 | | | 16 | | nV/ $\sqrt{\text{Hz}}$ |
| Input Current Noise | $f = 10\text{ kHz}$ | | 900 | | | 900 | | fA/ $\sqrt{\text{Hz}}$ |
| Differential Gain Error (NTSC) | $G = +2, R_L = 150\ \Omega$ | | 0.02 | | | 0.06 | | % |
| | $R_L = 1\text{ k}\Omega$ | | 0.02 | | | 0.02 | | % |
| Differential Phase Error (NTSC) | $G = +2, R_L = 150\ \Omega$ | | 0.11 | | | 0.15 | | Degrees |
| | $R_L = 1\text{ k}\Omega$ | | 0.02 | | | 0.03 | | Degrees |
| Crosstalk | $f = 5\text{ MHz}, G = +2$ | | -60 | | | -60 | | dB |
| DC PERFORMANCE | | | | | | | | |
| Input Offset Voltage | | | 1.8 | 11 | | 1.8 | 13 | mV |
| | $T_{MIN} - T_{MAX}$ | | | 27 | | | 32 | mV |
| Offset Drift | | | 10 | | | 15 | | $\mu\text{V}/^\circ\text{C}$ |
| Input Bias Current | | | 1.4 | 2.6 | | 2 | 4.5 | μA |
| | $T_{MIN} - T_{MAX}$ | | | 3.5 | | | 4.5 | μA |
| Input Offset Current | | | 0.1 | 0.75 | | 0.2 | 1.2 | μA |
| Open-Loop Gain | $R_L = 2\text{ k}\Omega$ | 88 | 96 | | 84 | 96 | | dB |
| | $T_{MIN} - T_{MAX}$ | | 96 | | | 96 | | dB |
| | $R_L = 150\ \Omega$ | 78 | 82 | | 76 | 82 | | dB |
| | $T_{MIN} - T_{MAX}$ | | 80 | | | 80 | | dB |
| INPUT CHARACTERISTICS | | | | | | | | |
| Input Resistance | | | 290 | | | 300 | | k Ω |
| Input Capacitance | | | 1.4 | | | 1.5 | | pF |
| Input Common-Mode Voltage Range | | | -5.2 to +4 | | | -5.2 to +4 | | V |
| Common-Mode Rejection Ratio | $V_{CM} = -5\text{ V to } +3.5\text{ V}$ | 72 | 88 | | 70 | 86 | | dB |
| OUTPUT CHARACTERISTICS | | | | | | | | |
| Output Voltage Swing | $R_L = 10\text{ k}\Omega$ | | -4.98 to +4.98 | | | -4.97 to +4.97 | | V |
| | $R_L = 2\text{ k}\Omega$ | -4.85 to +4.85 | -4.97 to +4.97 | | -4.8 to +4.8 | -4.9 to +4.9 | | V |
| | $R_L = 150\ \Omega$ | -4.45 to +4.3 | -4.6 to +4.6 | | -4.0 to +3.8 | -4.5 to +4.5 | | V |
| Output Current | $V_{OUT} = -4.5\text{ V to } +4.5\text{ V}$ | | 45 | | | 30 | | mA |
| | $T_{MIN} - T_{MAX}$ | | 45 | | | 30 | | mA |
| Short-Circuit Current | Sourcing | | 100 | | | 60 | | mA |
| | Sinking | | 160 | | | 100 | | mA |
| Capacitive Load Drive | $G = +1$ (AD8051/AD8052) | | 50 | | | | | pF |
| | $G = +2$ (AD8054) | | | | | 40 | | pF |

AD8051/AD8052/AD8054

| Parameter | Conditions | AD8051A/AD8052A | | | AD8054A | | | Unit |
|------------------------------|------------------------|-----------------|-----|------|---------|-------|------|------|
| | | Min | Typ | Max | Min | Typ | Max | |
| POWER SUPPLY | | | | | | | | |
| Operating Range | | 3 | | 12 | 3 | | 12 | V |
| Quiescent Current/Amplifier | | | 4.8 | 5.5 | | 2.875 | 3.4 | mA |
| Power Supply Rejection Ratio | $\Delta V_s = \pm 1$ | 68 | 80 | | 68 | 80 | | dB |
| OPERATING TEMPERATURE RANGE | RJ-5 | -40 | | +85 | | | | °C |
| | RM-8, R-8, RU-14, R-14 | -40 | | +125 | -40 | | +125 | °C |

ABSOLUTE MAXIMUM RATINGS

Table 4.

| Parameter | Ratings |
|---|-------------------------------|
| Supply Voltage | 12.6 V |
| Internal Power Dissipation ¹ | |
| SOIC Packages | Observe power derating curves |
| SOT-23 Package | Observe power derating curves |
| MSOP Package | Observe power derating curves |
| TSSOP Package | Observe power derating curves |
| Input Voltage (Common Mode) | $\pm V_s$ |
| Differential Input Voltage | ± 2.5 V |
| Output Short-Circuit Duration | Observe power derating curves |
| Storage Temperature Range (R) | -65°C to +150°C |
| Operating Temperature Range (A Grade) | -40°C to +125°C |
| Lead Temperature (Soldering 10 sec) | 300°C |

¹ See Table 5.

Stresses above those listed under Absolute Maximum Ratings may cause permanent damage to the device. This is a stress rating only; functional operation of the device at these or any other conditions above those indicated in the operational section of this specification is not implied. Exposure to absolute maximum rating conditions for extended periods may affect device reliability.

THERMAL RESISTANCE

Specification is for device in free air.

Table 5. Thermal Resistance

| Package Type | θ_{JA} | Unit |
|---------------|---------------|------|
| 8-Lead SOIC | 125 | °C/W |
| 5-Lead SOT-23 | 180 | °C/W |
| 8-Lead MSOP | 150 | °C/W |
| 14-Lead SOIC | 90 | °C/W |
| 14-Lead TSSOP | 120 | °C/W |

MAXIMUM POWER DISSIPATION

The maximum power that can be safely dissipated by the AD8051/AD8052/AD8054 is limited by the associated rise in junction temperature. The maximum safe junction temperature for plastic encapsulated devices is determined by the glass transition temperature of the plastic, approximately 150°C. Temporarily exceeding this limit can cause a shift in parametric performance due to a change in the stresses exerted on the die by the package. Exceeding a junction temperature of 175°C for an extended period can result in device failure.

While the AD8051/AD8052/AD8054 are internally short-circuit protected, this cannot be sufficient to guarantee that the maximum junction temperature (150°C) is not exceeded under all conditions. To ensure proper operation, it is necessary to observe the maximum power derating curves.



Figure 6. Maximum Power Dissipation vs. Temperature for AD8051/AD8052/AD8054

ESD CAUTION



ESD (electrostatic discharge) sensitive device. Charged devices and circuit boards can discharge without detection. Although this product features patented or proprietary protection circuitry, damage may occur on devices subjected to high energy ESD. Therefore, proper ESD precautions should be taken to avoid performance degradation or loss of functionality.

TYPICAL PERFORMANCE CHARACTERISTICS

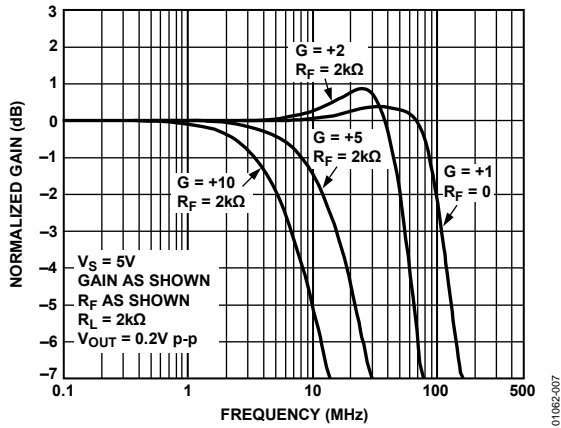

Figure 7. AD8051/AD8052 Normalized Gain vs. Frequency; $V_S = 5V$



Figure 10. AD8054 Normalized Gain vs. Frequency; $V_S = 5V$

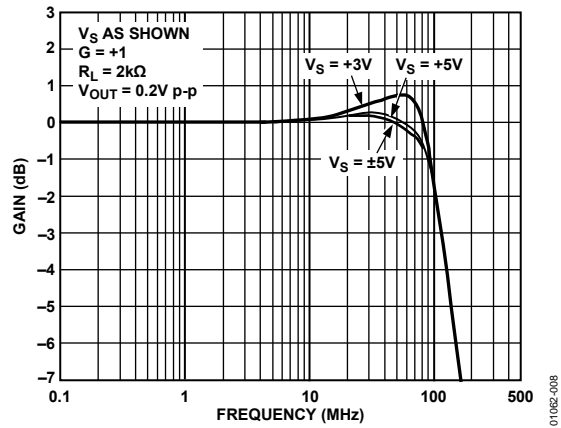

Figure 8. AD8051/AD8052 Gain vs. Frequency vs. Supply



Figure 11. AD8054 Gain vs. Frequency vs. Supply

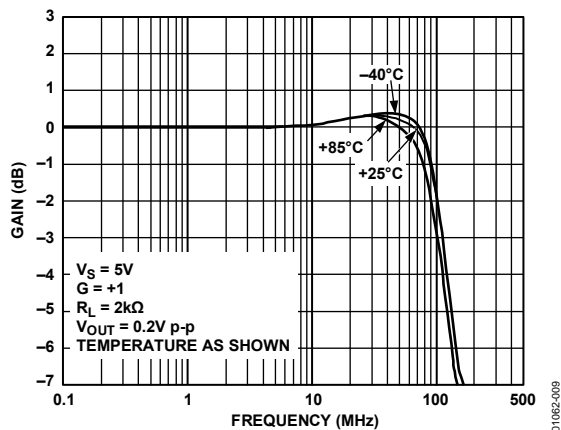

Figure 9. AD8051/AD8052 Gain vs. Frequency vs. Temperature

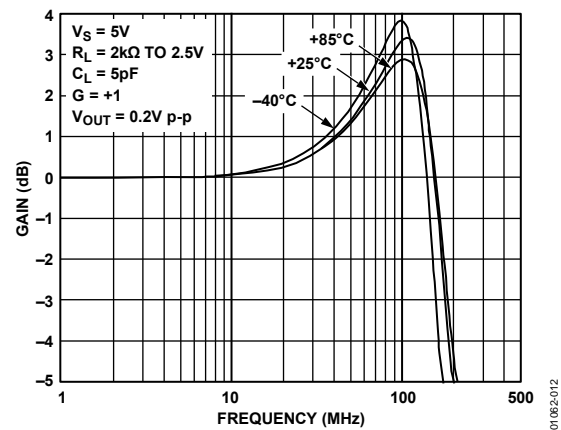

Figure 12. AD8054 Gain vs. Frequency vs. Temperature

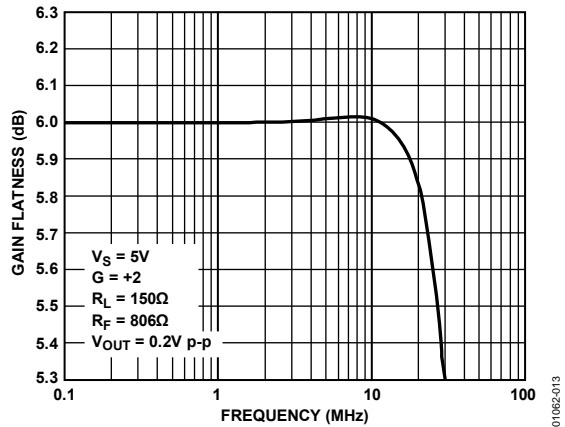

Figure 13. AD8051/AD8052 0.1 dB Gain Flatness vs. Frequency; $G = +2$

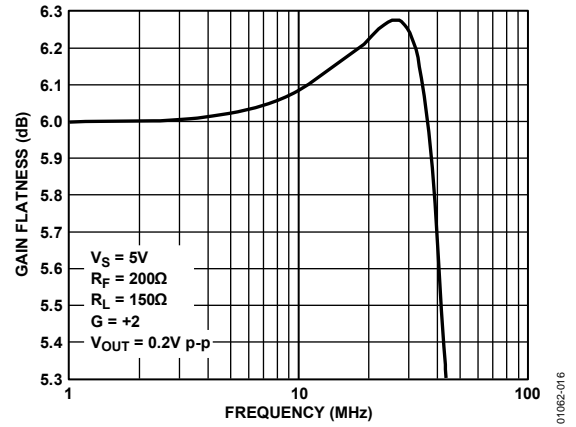

Figure 16. AD8054 0.1 dB Gain Flatness vs. Frequency; $G = +2$

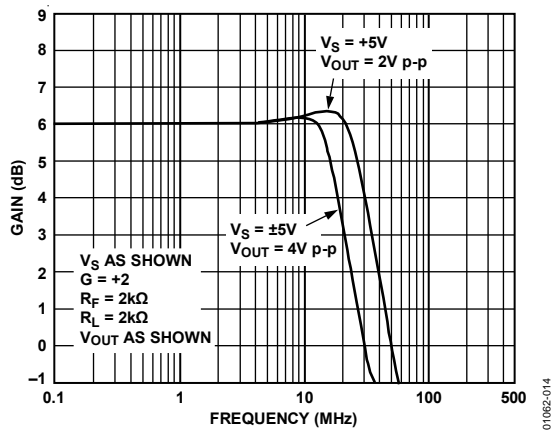

Figure 14. AD8051/AD8052 Large Signal Frequency Response; $G = +2$

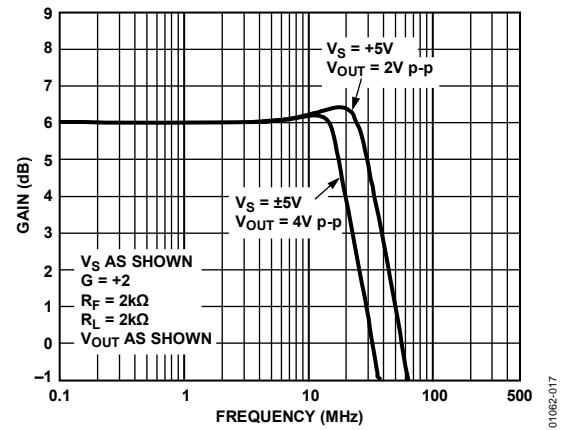

Figure 17. AD8054 Large Signal Frequency Response; $G = +2$

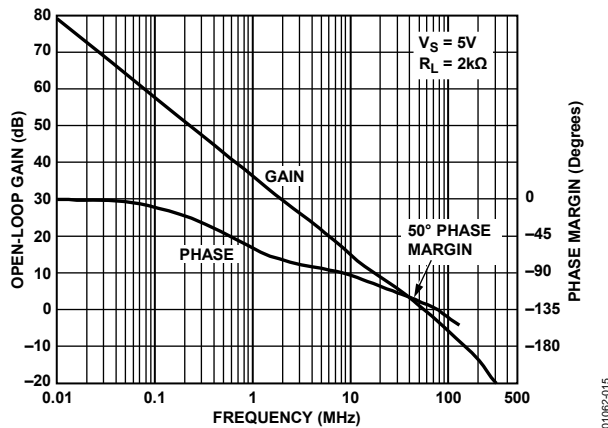

Figure 15. AD8051/AD8052 Open-Loop Gain and Phase vs. Frequency

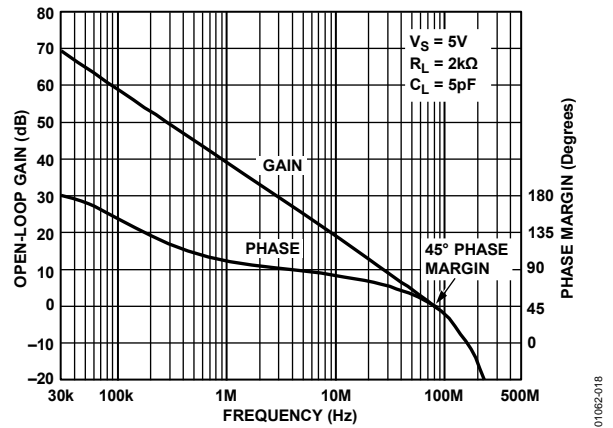

Figure 18. AD8054 Open-Loop Gain and Phase Margin vs. Frequency

AD8051/AD8052/AD8054



Figure 19. Total Harmonic Distortion

01062-019

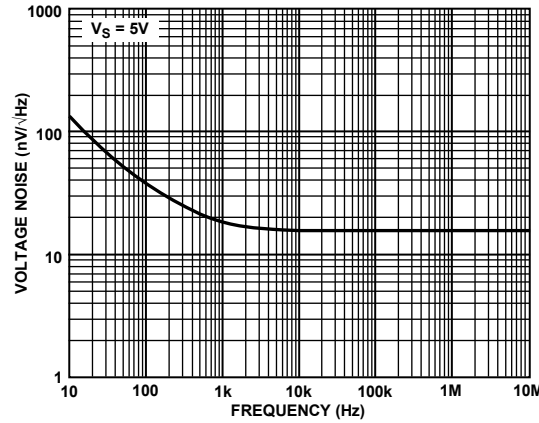

Figure 22. Input Voltage Noise vs. Frequency

01062-022



Figure 20. Worst Harmonic vs. Output Voltage

01062-020

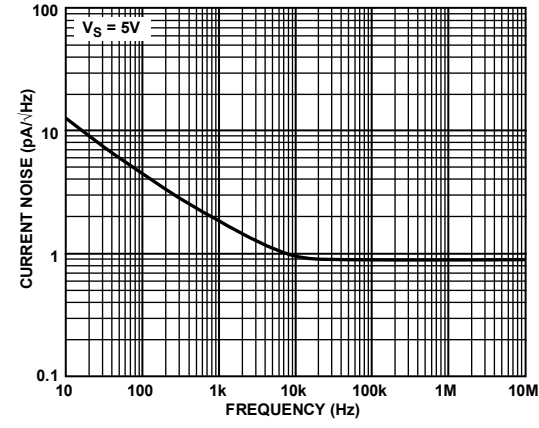

Figure 23. Input Current Noise vs. Frequency

01062-023

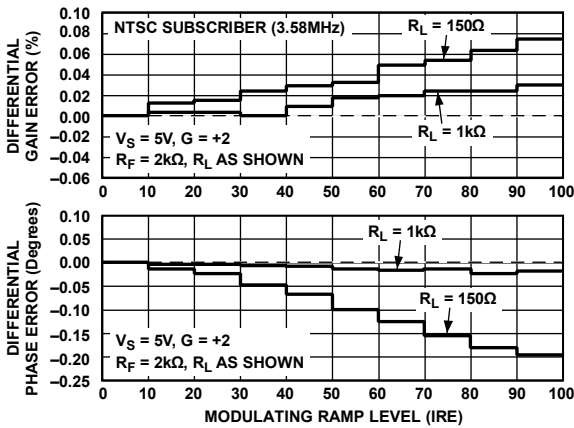

Figure 21. AD8051/AD8052 Differential Gain and Phase Errors

01062-021

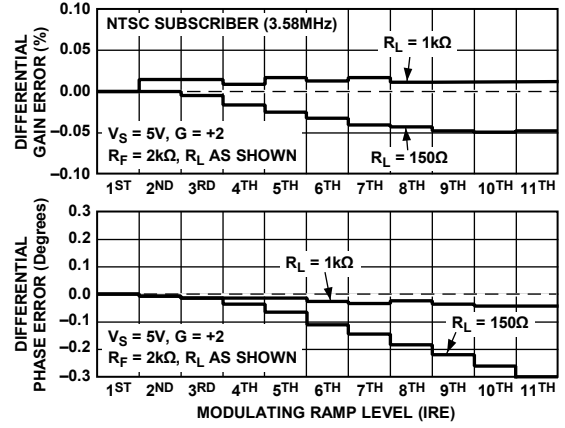

Figure 24. AD8054 Differential Gain and Phase Errors

01062-024



Figure 25. AD8052 Crosstalk (Output-to-Output) vs. Frequency

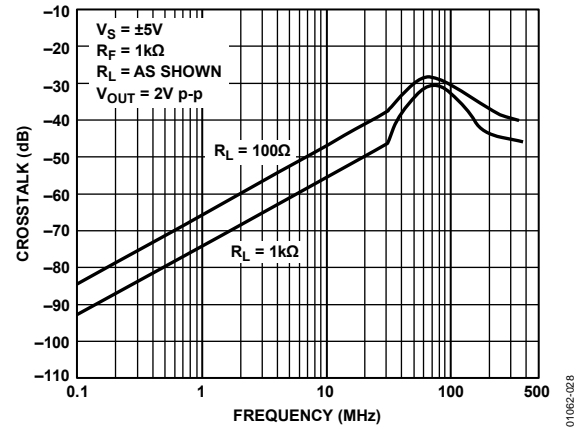

Figure 28. AD8054 Crosstalk (Output-to-Output) vs. Frequency



Figure 26. CMRR vs. Frequency

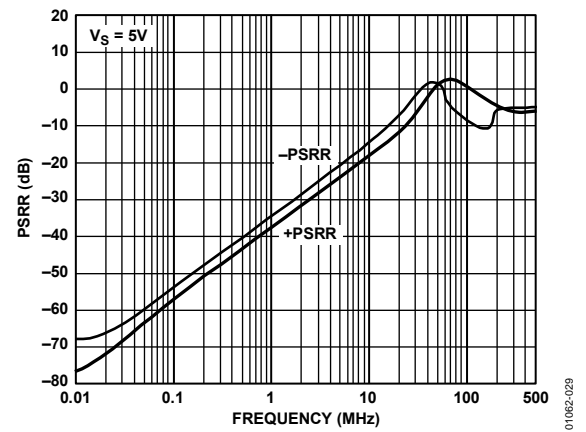

Figure 29. PSRR vs. Frequency

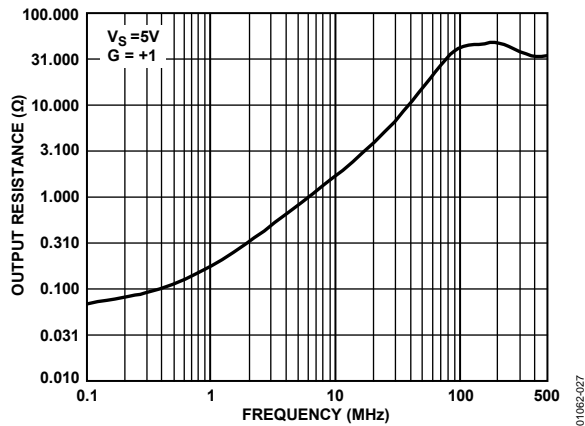

Figure 27. Closed-Loop Output Resistance vs. Frequency

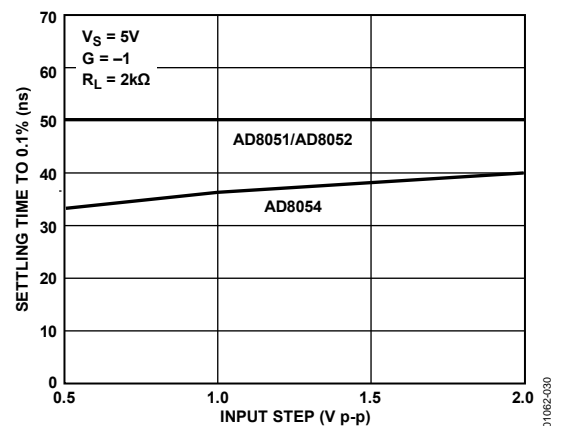

Figure 30. Settling Time vs. Input Step

AD8051/AD8052/AD8054



Figure 31. AD8051/AD8052 Output Saturation Voltage vs. Load Current



Figure 33. AD8054 Output Saturation Voltage vs. Load Current



Figure 32. Open-Loop Gain vs. Output Voltage

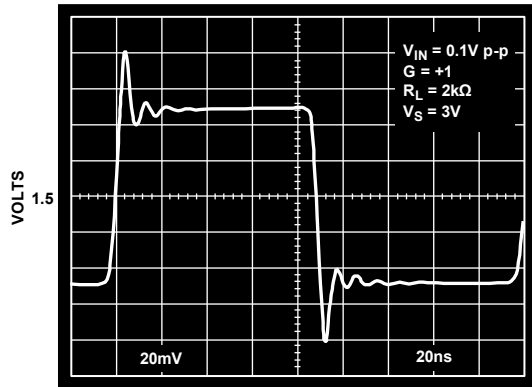

Figure 34. 100 mV Step Response, $G = +1$

01062-034

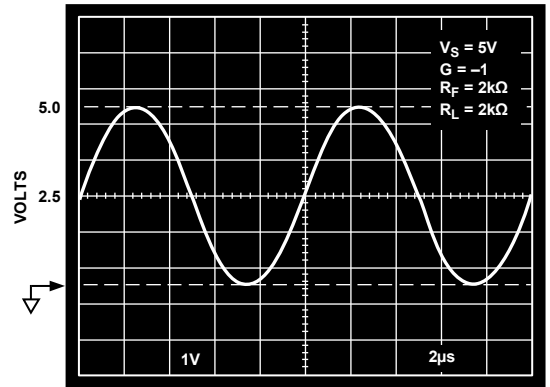

Figure 37. Output Swing; $G = -1$, $R_L = 2k\Omega$

01062-037

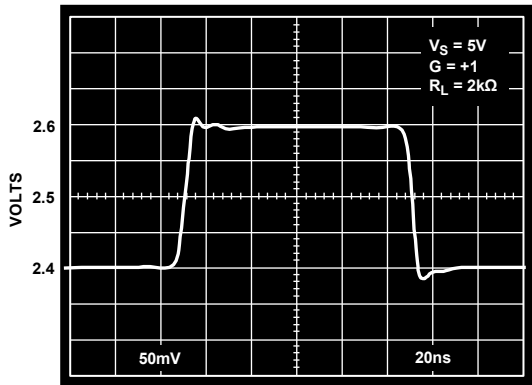

Figure 35. AD8051/AD8052 200 mV Step Response; $V_S = 5V$, $G = +1$

01062-035

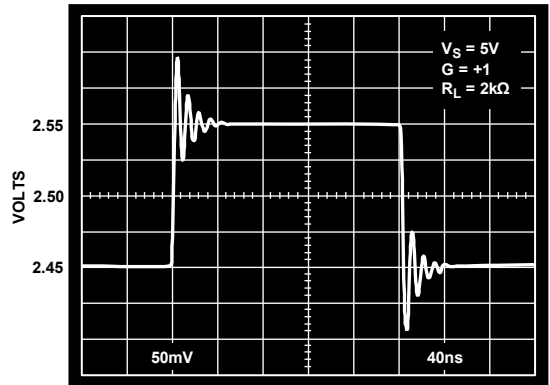

Figure 38. AD8054 100 mV Step Response; $V_S = 5V$, $G = +1$

01062-038

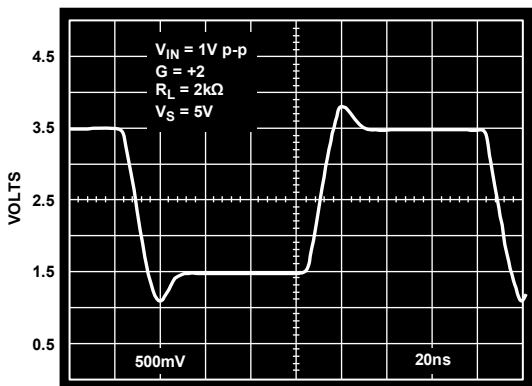

Figure 36. Large Signal Step Response; $V_S = 5V$, $G = +2$

01062-036

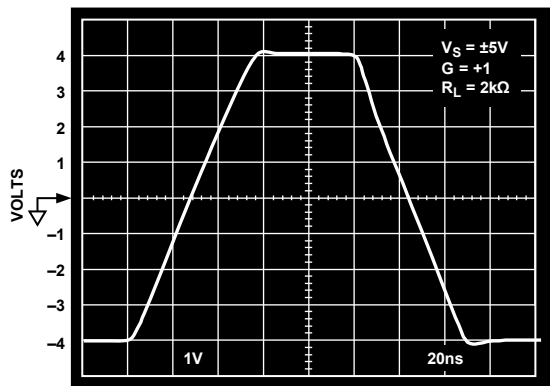

Figure 39. Large Signal Step Response; $V_S = \pm 5V$, $G = +1$

01062-039

THEORY OF OPERATION

CIRCUIT DESCRIPTION

The AD8051/AD8052/AD8054 are fabricated on the Analog Devices, Inc. proprietary eXtra-Fast Complementary Bipolar (XFCB) process, which enables the construction of PNP and NPN transistors with similar f_T s in the 2 GHz to 4 GHz region. The process is dielectrically isolated to eliminate the parasitic and latch-up problems caused by junction isolation. These features allow the construction of high frequency, low distortion amplifiers with low supply currents. This design uses a differential output input stage to maximize bandwidth and headroom (see Figure 40). The smaller signal swings required on the first stage outputs (nodes SIP, SIN) reduce the effect of nonlinear currents due to junction capacitances and improve the distortion performance. This design achieves harmonic distortion of -80 dBc @ 1 MHz into 100Ω with $V_{OUT} = 2$ V p-p (gain = +1) on a single 5 V supply.

The inputs of the device can handle voltages from -0.2 V below the negative rail to within 1 V of the positive rail. Exceeding these values do not cause phase reversal; however, the input ESD devices begin to conduct if the input voltages exceed the rails by greater than 0.5 V. During this overdrive condition, the output stays at the rail.

The rail-to-rail output range of the AD8051/AD8052/AD8054 is provided by a complementary common emitter output stage. High output drive capability is provided by injecting all output stage predriver currents directly into the bases of the output devices Q8 and Q36. Biasing of Q8 and Q36 is accomplished by I8 and I5, along with a common-mode feedback loop (not shown). This circuit topology allows the AD8051/AD8052 to drive 45 mA of output current and allows the AD8054 to drive 30 mA of output current with the outputs within 0.5 V of the supply rails.

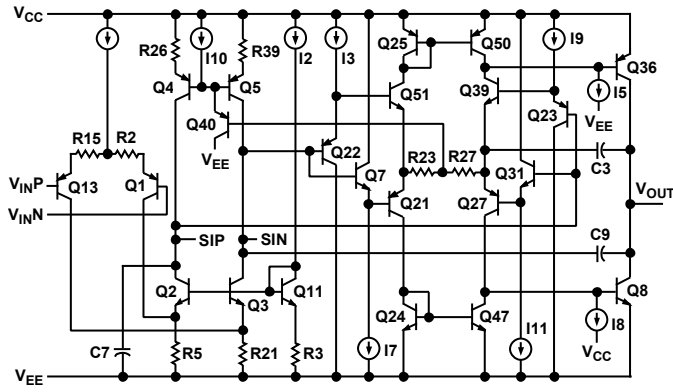

Figure 40. AD8051/AD8052 Simplified Schematic

01062-945

APPLICATION INFORMATION

OVERDRIVE RECOVERY

Overdrive of an amplifier occurs when the output and/or input range is exceeded. The amplifier must recover from this overdrive condition. As shown in Figure 41, the AD8051/AD8052/AD8054 recover within 60 ns from negative overdrive and within 45 ns from positive overdrive.



Figure 41. Overdrive Recovery

DRIVING CAPACITIVE LOADS

Consider the AD8051/AD8052 in a closed-loop gain of +1 with $V_S = 5\text{ V}$ and a load of $2\text{ k}\Omega$ in parallel with 50 pF . Figure 42 and Figure 43 show their frequency and time domain responses, respectively, to a small-signal excitation. The capacitive load drive of the AD8051/AD8052/AD8054 can be increased by adding a low value resistor in series with the load. Figure 44 and Figure 45 show the effect of a series resistor on the capacitive drive for varying voltage gains. As the closed-loop gain is increased, the larger phase margin allows for larger capacitive loads with less peaking. Adding a series resistor with lower closed-loop gains accomplishes the same effect. For large capacitive loads, the frequency response of the amplifier is dominated by the roll-off of the series resistor and the load capacitance.

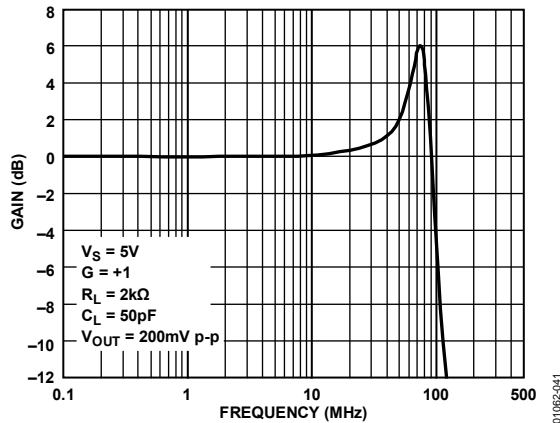

Figure 42. AD8051/AD8052 Closed-Loop Frequency Response; $C_L = 50\text{ pF}$



Figure 43. AD8051/AD8052 200 mV Step Response; $C_L = 50\text{ pF}$



Figure 44. AD8051/AD8052 Capacitive Load Drive vs. Closed-Loop Gain



Figure 45. AD8054 Capacitive Load Drive vs. Closed-Loop Gain

AD8051/AD8052/AD8054

LAYOUT CONSIDERATIONS

The specified high speed performance of the AD8051/AD8052/AD8054 requires careful attention to board layout and component selection. Proper RF design techniques and low parasitic component selection are necessary.

The PCB should have a ground plane covering all unused portions of the component side of the board to provide a low impedance path. The ground plane should be removed from the area near the input pins to reduce parasitic capacitance.

Chip capacitors should be used for supply bypassing. One end should be connected to the ground plane and the other within 3 mm of each power pin. An additional large (4.7 μF to 10 μF) tantalum electrolytic capacitor should be connected in parallel, but not necessarily so close, to supply current for fast, large signal changes at the output.

The feedback resistor should be located close to the inverting input pin to keep the parasitic capacitance at this node to a minimum. Parasitic capacitance of less than 1 pF at the inverting input can significantly affect high speed performance.

Stripline design techniques should be used for long signal traces (greater than about 25 mm). These should be designed with a characteristic impedance of 50 Ω or 75 Ω and be properly terminated at each end.

ACTIVE FILTERS

Active filters at higher frequencies require wider bandwidth op amps to work effectively. Excessive phase shift produced by lower frequency op amps can significantly affect active filter performance.

Figure 46 shows an example of a 2 MHz biquad bandwidth filter that uses three op amps of an AD8054. Such circuits are sometimes used in medical ultrasound systems to lower the

noise bandwidth of the analog signal before analog-to-digital conversion.

Note that the unused amplifier's inputs should be tied to ground.

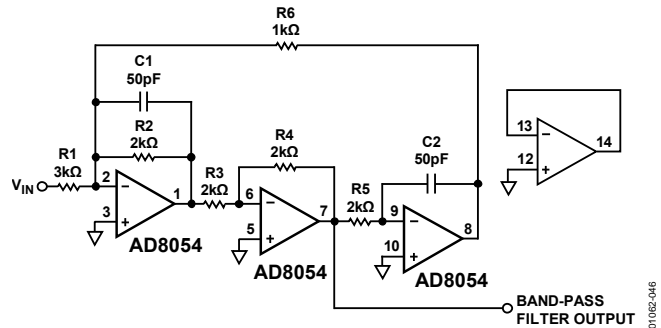

Figure 46. 2 MHz Biquad Band-Pass Filter Using AD8054

The frequency response of the circuit is shown in Figure 47.



Figure 47. Frequency Response of 2 MHz Band-Pass Biquad Filter

ANALOG-TO-DIGITAL AND DIGITAL-TO-ANALOG APPLICATIONS

Figure 50 is a schematic showing the AD8051 used as a driver for an AD9201, a 10-bit, 20 MSPS, dual analog-to-digital converter. This converter is designed to convert I and Q signals in communications systems. In this application, only the I channel is being driven. The I channel is enabled by applying a logic high to SELECT (Pin 13).

The AD8051 is running from a dual supply and is configured for a gain of +2. The input signal is terminated in 50 Ω and the output is 2 V p-p, which is the maximum input range of the AD9201. The 22 Ω series resistor limits the maximum current that flows and helps to lower the distortion of the ADC.

The AD9201 has differential inputs for each channel. These are designated the A and B inputs. The B inputs of each channel are connected to VREF (Pin 22), which supplies a positive reference of 2.5 V. Each of the B inputs has a small low-pass filter that also helps to reduce distortion.

The output of the op amp is ac-coupled into INA-I (Pin 16) via two parallel capacitors to provide good high frequency and low frequency coupling. The 1 kΩ resistor references the signal to VREF that is applied to INB-I. Thus, INA-I swings both positive and negative with respect to the bias voltage applied to INB-I.

With the sampling clock running at 20 MSPS, the analog-to-digital output was analyzed with a digital analyzer. Two input frequencies were used, 1 MHz and 9.5 MHz, which is just short of the Nyquist frequency. These signals were well filtered to minimize any harmonics.

Figure 48 shows the FFT response of the ADC for the case of a 1 MHz analog input. The SFDR is 71.66 dB, and the analog-to-digital is producing 8.8 ENOB (effective number of bits). When the analog frequency was raised to 9.5 MHz, the SFDR was

reduced to -60.18 dB and the ADC operated with 8.46 ENOBs as shown in Figure 49. The inclusion of the AD8051 in the circuit did not worsen the distortion performance of the AD9201.

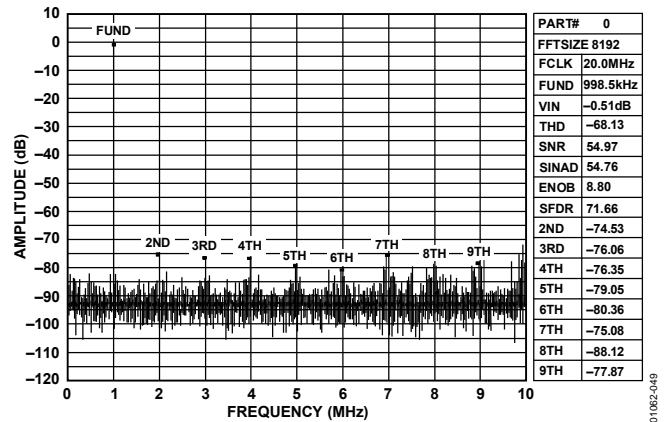

Figure 48. FFT Plot for AD8051 Driving the AD9201 at 1 MHz

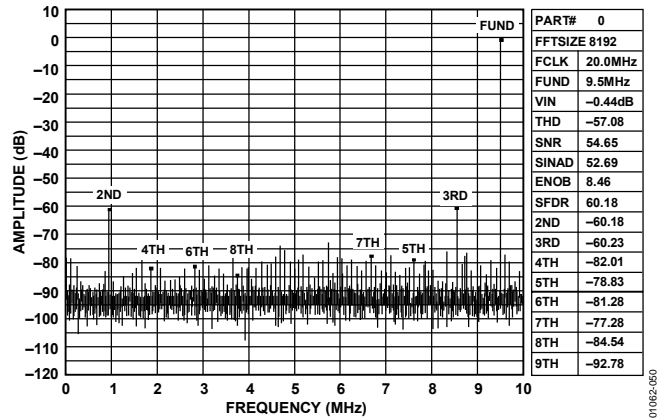

Figure 49. FFT Plot for AD8051 Driving the AD9201 at 9.5 MHz

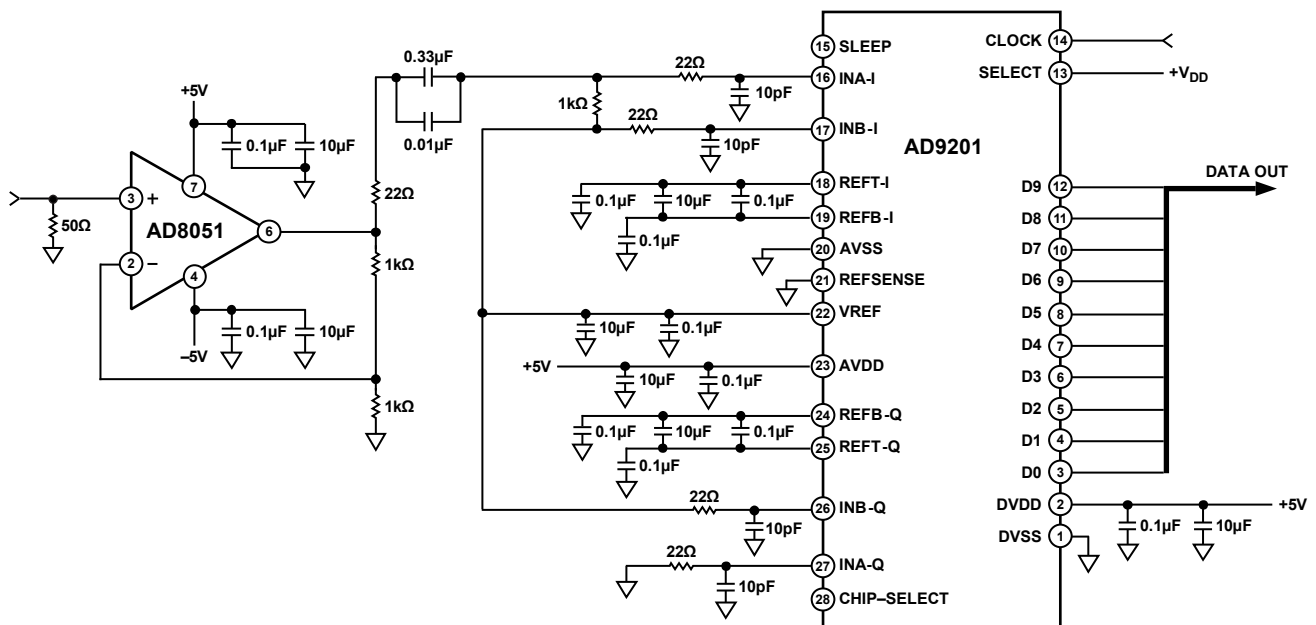

Figure 50. The AD8051 Driving an AD9201, a 10-Bit, 20 MSPS Analog-to-Digital Converter

AD8051/AD8052/AD8054

SYNC STRIPPER

Synchronizing pulses are sometimes carried on video signals so as not to require a separate channel to carry the synchronizing information. However, for some functions, such as analog-to-digital conversion, it is not desirable to have the sync pulses on the video signal. These pulses reduce the dynamic range of the video signal and do not provide any useful information for such a function.

A sync stripper removes the synchronizing pulses from a video signal while passing all the useful video information. Figure 51 shows a practical single-supply circuit that uses only a single AD8051. It is capable of directly driving a reverse terminated video line.



Figure 51. Sync Stripper

The video signal plus sync is applied to the noninverting input with the proper termination. The amplifier gain is set to 2 via the two 1 kΩ resistors in the feedback circuit. A bias voltage must be applied to R1 so that the input signal has the sync pulses stripped at the proper level.

The blanking level of the input video pulse is the desired place to remove the sync information. This level is multiplied by 2 by the amplifier. This level must be at ground at the output for the sync stripping action to take place. Since the gain of the amplifier from the input of R1 to the output is -1 , a voltage equal to $2 \times V_{BLANK}$ must be applied to make the blanking level come out at ground.

SINGLE-SUPPLY COMPOSITE VIDEO LINE DRIVER

Many composite video signals have their blanking level at ground and have video information that is both positive and negative. Such signals require dual-supply amplifiers to pass them. However, by ac level shifting, a single-supply amplifier can be used to pass these signals. The following complications can arise from such techniques.

Signals of bounded peak-to-peak amplitude that vary in duty cycle require larger dynamic swing capacity than their (bounded) peak-to-peak amplitude after they are ac-coupled. As a worst case, the dynamic signal swing will approach twice the peak-to-peak value. The two conditions that define the maximum

dynamic swing requirements are a signal that is mostly low but goes high with a duty cycle that is a small fraction of a percent, and the other extreme defined by the opposite condition.

The worst case of composite video is not quite this demanding. One bounding condition is a signal that is mostly black for an entire frame but has a white (full amplitude) minimum width spike at least once in a frame.

The other extreme is for a full white video signal. The blanking intervals and sync tips of such a signal have negative-going excursions in compliance with the composite video specifications. The combination of horizontal and vertical blanking intervals limit such a signal to being at the highest (white) level for a maximum of about 75% of the time.

As a result of the duty cycles between the two extremes previously presented, a 1 V p-p composite video signal that is multiplied by a gain of 2 requires about 3.2 V p-p of dynamic voltage swing at the output for an op amp to pass a composite video signal of arbitrarily varying duty cycle without distortion.

Some circuits use a sync tip clamp to hold the sync tips at a relatively constant level to lower the amount of dynamic signal swing required. However, these circuits can have artifacts, such as sync tip compression, unless they are driven by a source with a very low output impedance. The AD8051/AD8052/AD8054 have adequate signal swing when running on a single 5 V supply to handle an ac-coupled composite video signal.

The input to the circuit in Figure 52 is a standard composite (1 V p-p) video signal that has the blanking level at ground. The input network level shifts the video signal by means of ac coupling. The noninverting input of the op amp is biased to half of the supply voltage.

The feedback circuit provides unity gain for the dc-biasing of the input and provides a gain of 2 for any signals that are in the video bandwidth. The output is ac-coupled and terminated to drive the line.

The capacitor values were selected for providing minimum tilt or field time distortion of the video signal. These values would be required for video that is considered to be studio or broadcast quality. However, if a lower consumer grade of video, sometimes referred to as consumer video, is all that is desired, the values and the cost of the capacitors can be reduced by as much as a factor of five with minimum visible degradation in the picture.



Figure 52. Single-Supply Composite Video Line Driver

OUTLINE DIMENSIONS

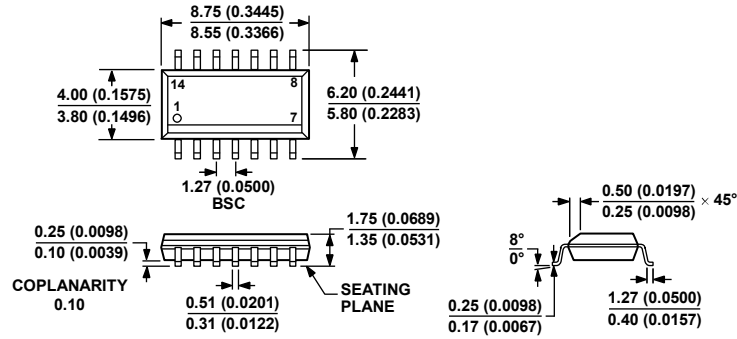

COMPLIANT TO JEDEC STANDARDS MS-012-AB
 CONTROLLING DIMENSIONS ARE IN MILLIMETERS; INCH DIMENSIONS
 (IN PARENTHESES) ARE ROUNDED-OFF MILLIMETER EQUIVALENTS FOR
 REFERENCE ONLY AND ARE NOT APPROPRIATE FOR USE IN DESIGN.

Figure 53. 14-Lead Standard Small Outline Package [SOIC_N]
 Narrow Body (R-14)

Dimensions shown in millimeters and (inches)

060606-A

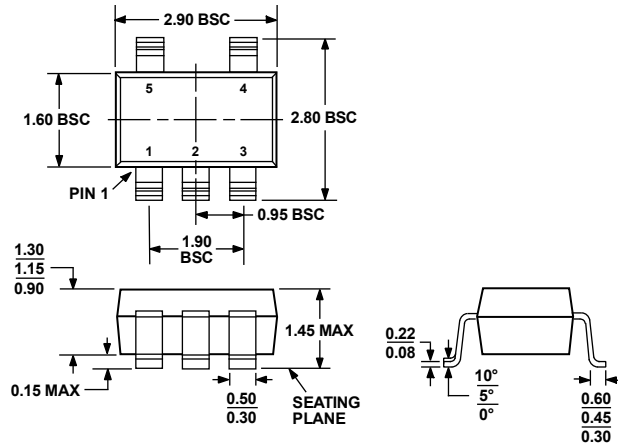

COMPLIANT TO JEDEC STANDARDS MO-178-AA

Figure 54. 5-Lead Small Outline Transistor Package [SOT-23]
 (RJ-5)

Dimensions shown in millimeters

AD8051/AD8052/AD8054



COMPLIANT TO JEDEC STANDARDS MO-187-AA

Figure 55. 8-Lead Mini Small Outline Package [MSOP] (RM-8)

Dimensions shown in millimeters



COMPLIANT TO JEDEC STANDARDS MS-012-AA

CONTROLLING DIMENSIONS ARE IN MILLIMETERS; INCH DIMENSIONS (IN PARENTHESES) ARE ROUNDED-OFF MILLIMETER EQUIVALENTS FOR REFERENCE ONLY AND ARE NOT APPROPRIATE FOR USE IN DESIGN.

Figure 56. 8-Lead Standard Small Outline Package [SOIC_N] Narrow Body (R-8)

Dimensions shown in millimeters and (inches)

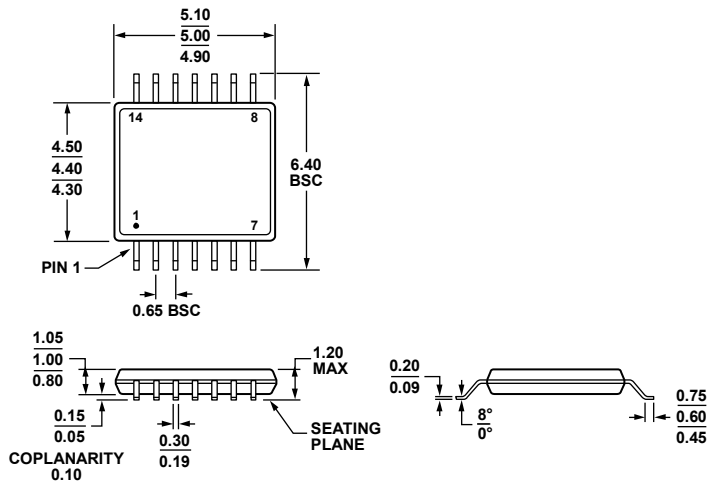

COMPLIANT TO JEDEC STANDARDS MO-153-AB-1

Figure 57. 14-Lead Thin Shrink Small Outline Package [TSSOP] (RU-14)

Dimensions shown in millimeters

ORDERING GUIDE

| Model | Temperature Range | Package Description | Package Option | Branding |
|-------------------------------|-------------------|-----------------------------------|----------------|----------|
| AD8051AR | -40°C to +125°C | 8-Lead SOIC_N | R-8 | |
| AD8051AR-REEL | -40°C to +125°C | 8-Lead SOIC_N, 13" Tape and Reel | R-8 | |
| AD8051AR-REEL7 | -40°C to +125°C | 8-Lead SOIC_N, 7" Tape and Reel | R-8 | |
| AD8051ARZ ¹ | -40°C to +85°C | 8-Lead SOIC_N | R-8 | |
| AD8051ARZ-REEL ¹ | -40°C to +85°C | 8-Lead SOIC_N, 13" Tape and Reel | R-8 | |
| AD8051ARZ-REEL7 ¹ | -40°C to +85°C | 8-Lead SOIC_N, 7" Tape and Reel | R-8 | |
| AD8051ART-R2 | -40°C to +85°C | 5-Lead SOT-23, 7" Tape and Reel | RJ-5 | H2A |
| AD8051ART-REEL | -40°C to +85°C | 5-Lead SOT-23, 13" Tape and Reel | RJ-5 | H2A |
| AD8051ART-REEL7 | -40°C to +85°C | 5-Lead SOT-23, 7" Tape and Reel | RJ-5 | H2A |
| AD8051ARTZ-R2 ¹ | -40°C to +85°C | 5-Lead SOT-23, 7" Tape and Reel | RJ-5 | H06 |
| AD8051ARTZ-REEL ¹ | -40°C to +85°C | 5-Lead SOT-23, 13" Tape and Reel | RJ-5 | H06 |
| AD8051ARTZ-REEL7 ¹ | -40°C to +85°C | 5-Lead SOT-23, 7" Tape and Reel | RJ-5 | H06 |
| AD8052AR | -40°C to +125°C | 8-Lead SOIC_N | R-8 | |
| AD8052AR-REEL | -40°C to +125°C | 8-Lead SOIC_N, 13" Tape and Reel | R-8 | |
| AD8052AR-REEL7 | -40°C to +125°C | 8-Lead SOIC_N, 7" Tape and Reel | R-8 | |
| AD8052ARZ ¹ | -40°C to +125°C | 8-Lead SOIC_N | R-8 | |
| AD8052ARZ-REEL ¹ | -40°C to +125°C | 8-Lead SOIC_N, 13" Tape and Reel | R-8 | |
| AD8052ARZ-REEL7 ¹ | -40°C to +125°C | 8-Lead SOIC_N, 7" Tape and Reel | R-8 | |
| AD8052ARM | -40°C to +125°C | 8-Lead MSOP | RM-8 | H4A |
| AD8052ARM-REEL | -40°C to +125°C | 8-Lead MSOP, 13" Tape and Reel | RM-8 | H4A |
| AD8052ARM-REEL7 | -40°C to +125°C | 8-Lead MSOP, 7" Tape and Reel | RM-8 | H4A |
| AD8052ARMZ ¹ | -40°C to +125°C | 8-Lead MSOP | RM-8 | H4A# |
| AD8052ARMZ-REEL7 ¹ | -40°C to +125°C | 8-Lead MSOP, 7" Tape and Reel | RM-8 | H4A# |
| AD8054AR | -40°C to +125°C | 14-Lead SOIC_N | R-14 | |
| AD8054AR-REEL | -40°C to +125°C | 14-Lead SOIC_N, 13" Tape and Reel | R-14 | |
| AD8054AR-REEL7 | -40°C to +125°C | 14-Lead SOIC_N, 7" Tape and Reel | R-14 | |
| AD8054ARZ ¹ | -40°C to +125°C | 14-Lead SOIC_N | R-14 | |
| AD8054ARZ-REEL ¹ | -40°C to +125°C | 14-Lead SOIC_N, 13" Tape and Reel | R-14 | |
| AD8054ARZ-REEL7 ¹ | -40°C to +125°C | 14-Lead SOIC_N, 7" Tape and Reel | R-14 | |
| AD8054ARU | -40°C to +125°C | 14-Lead TSSOP | RU-14 | |
| AD8054ARU-REEL | -40°C to +125°C | 14-Lead TSSOP, 13" Tape and Reel | RU-14 | |
| AD8054ARU-REEL7 | -40°C to +125°C | 14-Lead TSSOP, 7" Tape and Reel | RU-14 | |
| AD8054ARUZ ¹ | -40°C to +125°C | 14-Lead TSSOP | RU-14 | |
| AD8054ARUZ-REEL ¹ | -40°C to +125°C | 14-Lead TSSOP, 13" Tape and Reel | RU-14 | |
| AD8054ARUZ-REEL7 ¹ | -40°C to +125°C | 14-Lead TSSOP, 7" Tape and Reel | RU-14 | |

¹ Z = RoHS Compliant Part. # denotes lead-free product may be top or bottom marked.

NOTES

Компания «Life Electronics» занимается поставками электронных компонентов импортного и отечественного производства от производителей и со складов крупных дистрибьюторов Европы, Америки и Азии.

С конца 2013 года компания активно расширяет линейку поставок компонентов по направлению коаксиальный кабель, кварцевые генераторы и конденсаторы (керамические, пленочные, электролитические), за счёт заключения дистрибьюторских договоров

Мы предлагаем:

- Конкуренеспособные цены и скидки постоянным клиентам.
- Специальные условия для постоянных клиентов.
- Подбор аналогов.
- Поставку компонентов в любых объемах, удовлетворяющих вашим потребностям.
- Приемлемые сроки поставки, возможна ускоренная поставка.
- Доставку товара в любую точку России и стран СНГ.
- Комплексную поставку.
- Работу по проектам и поставку образцов.
- Формирование склада под заказчика.
- Сертификаты соответствия на поставляемую продукцию (по желанию клиента).
- Тестирование поставляемой продукции.
- Поставку компонентов, требующих военную и космическую приемку.
- Входной контроль качества.
- Наличие сертификата ISO.

В составе нашей компании организован Конструкторский отдел, призванный помогать разработчикам, и инженерам.

Конструкторский отдел помогает осуществить:

- Регистрацию проекта у производителя компонентов.
- Техническую поддержку проекта.
- Защиту от снятия компонента с производства.
- Оценку стоимости проекта по компонентам.
- Изготовление тестовой платы монтаж и пусконаладочные работы.



Тел: +7 (812) 336 43 04 (многоканальный)

Email: org@lifeelectronics.ru