



### FEATURES



Highest power rating with long life – Standard parts stocked\*

### APPLICATIONS

Wearable electronic & IoT devices – Memory backup circuits

Nominal Voltage	3.7VDC (4.2VDC to 3.0VDC)	
Operating Temperature Range	-20°C to +60°C	
Storage Temperature Range	-20°C to +60°C (one month) -20°C to +40°C (up to 3 months) -20°C to +25°C (up to 6 months)	
Storage Capacity	Nominal	See part listing 0.2C rate, 3.0V cut-off
	Minimum	See part listing 0.2C rate, 3.0V cut-off
Charging Voltage	4.2VDC $\pm$ 0.03V	
Charging current	0.5CA	
Charging Time	< 3.0 hours	
Charging method	Constant Current/ Constant Voltage (CCCV)	
Discharge Current	Standard	0.2CA
	Maximum	2CA
Discharge Cut-off Voltage	3.0V	
Anode	Graphite	
Cathode	Lithium nickel manganese cobalt oxide	
Certification	UL1642 – MH28281	

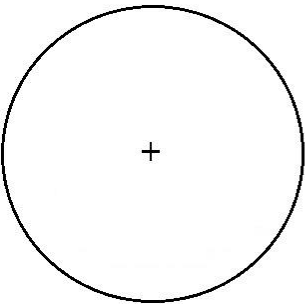
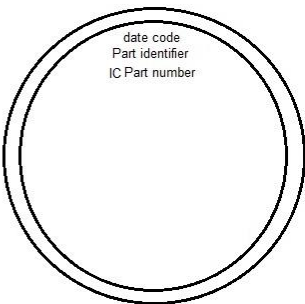
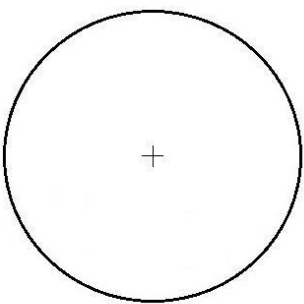
### Markings

Standard (bare cells)		Non-Standard Terminations	
			
Front	Back	Front	Back



### Standard Coin Cell Options

IC Part Number	Capacity (mAh)		Charging Current (mA)	Discharge Current (mA)		Maximum Internal Resistance (mΩ)	Approx. Weight (g)	Maximum Diameter (D mm)	Thickness (T mm)
	Nom.	Min.		STD	MAX				
RJD2048	120	110	55	22	220	700	4.2	20.02	5.0
RJD2430C1	110	104	52	21	208	500	4.5	24.5	3.15
RJD2440	150	140	70	28	280	800	5.4	24.5	4.3
RJD2450	200	190	95	38	380	500	6.5	24.5	5.4
RJD3032	200	190	95	38	380	600	7.2	30	3.4
RJD3048	300	290	145	58	580	400	9.3	30	4.9
RJD3555	500	490	245	98	980	200	14.1	35.2	5.7

### Standard PCM & Connector Options

IC Part Number	Capacity (mAh)		Charging Current (mA)	Discharge Current (mA)		Maximum Internal Resistance (mΩ)	Approx. Weight (g)	Maximum Diameter (D mm)	Thickness (T mm)
	Nom.	Min.		STD	MAX				
RJD3048HPPV30M	300	290	145	58	580	700	9.3	30	5.7
RJD3555HPPV30M	500	490	245	98	980	500	14.1	35.2	6.4

### Standard Leaded Options

IC Part Number	Capacity (mAh)		Charging Current (mA)	Discharge Current (mA)		Maximum Internal Resistance (mΩ)	Approx. Weight (g)	Maximum Diameter (D mm)	Thickness (T mm)
	Nom.	Min.		STD	MAX				
RJD2048ST1	120	110	55	22	220	700	4.2	20.02	5.4
RJD2430C1ST1	110	104	52	21	208	500	4.5	24.5	3.55
RJD2440ST1	150	140	70	28	280	800	5.4	24.5	4.7
RJD2450ST1	200	190	95	38	380	500	6.5	24.5	5.8
RJD3032ST1	200	190	95	38	380	600	7.2	30	3.8
RJD3048ST1	300	290	145	58	580	400	9.3	30	5.3
RJD3555ST1	500	490	245	98	980	200	14.1	35.2	6.1



### Cell Dimensions

IC Part Number	Fresh Cell				Cycled cell (after 500 cycles)	
	Shipping (Charged)		Full Charge		Full Charge	
	Maximum Diameter (D mm)	Maximum Thickness (T mm)	Maximum Diameter (D mm)	Maximum Thickness (T mm)	Maximum Diameter (D mm)	Maximum Thickness (T mm)
RJD2032C1*	20.02	3.5	20	3.6	20	3.7
RJD2048*	20.02	5	20	5.2	20	5.3
RJD2430C1*	24.5	3.15	24.5	3.25	24.5	3.3
RJD2440*	24.5	4.3	24.5	4.4	24.5	4.5
RJD2450*	24.5	5.4	24.5	5.5	24.5	5.6
RJD3032*	30	3.4	30	3.5	30	3.6
RJD3048*	30	4.9	30	4.9	30	5.2
RJD3555*	35.2	5.7	35.2	5.8	35.2	6.3

### Part Numbering

RJD 2032C1      A      B      C      D      E  
 Section 1      Section 2      Section 3      Section 4      Section 5      Section 6

**Section 1** – IC standard part number (Bare cell)

**Section 2** –Termination style

### Termination Styles

Contact IC for detailed drawings

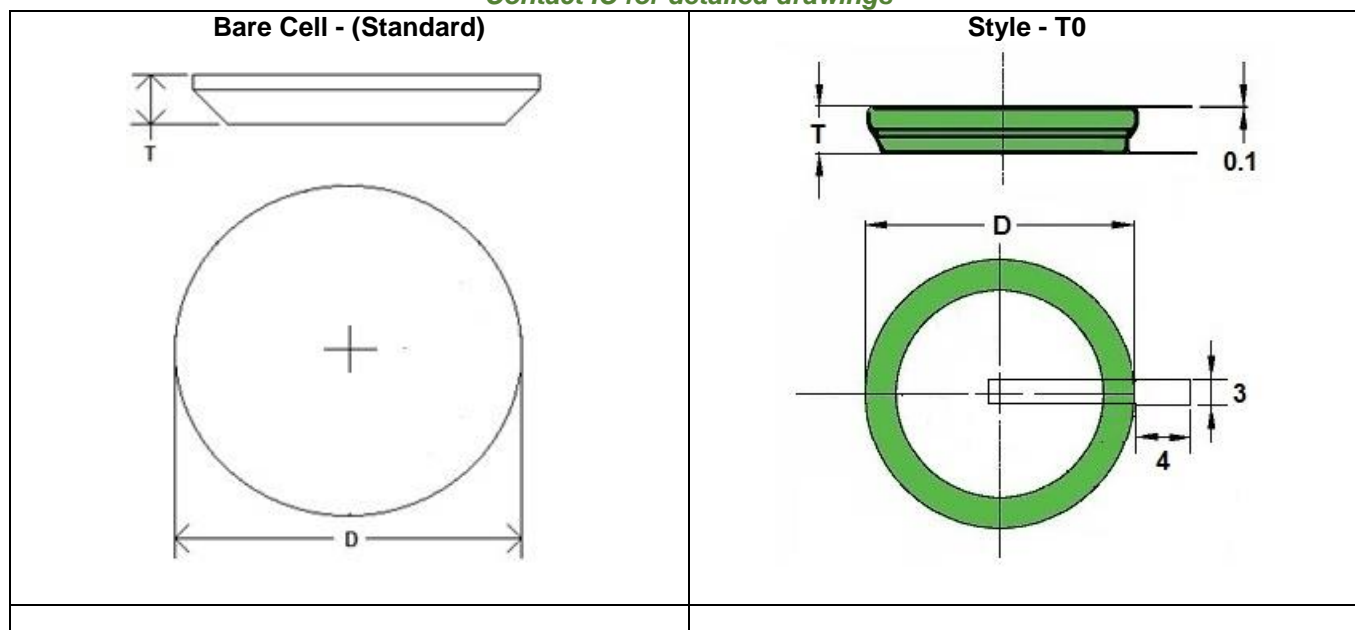

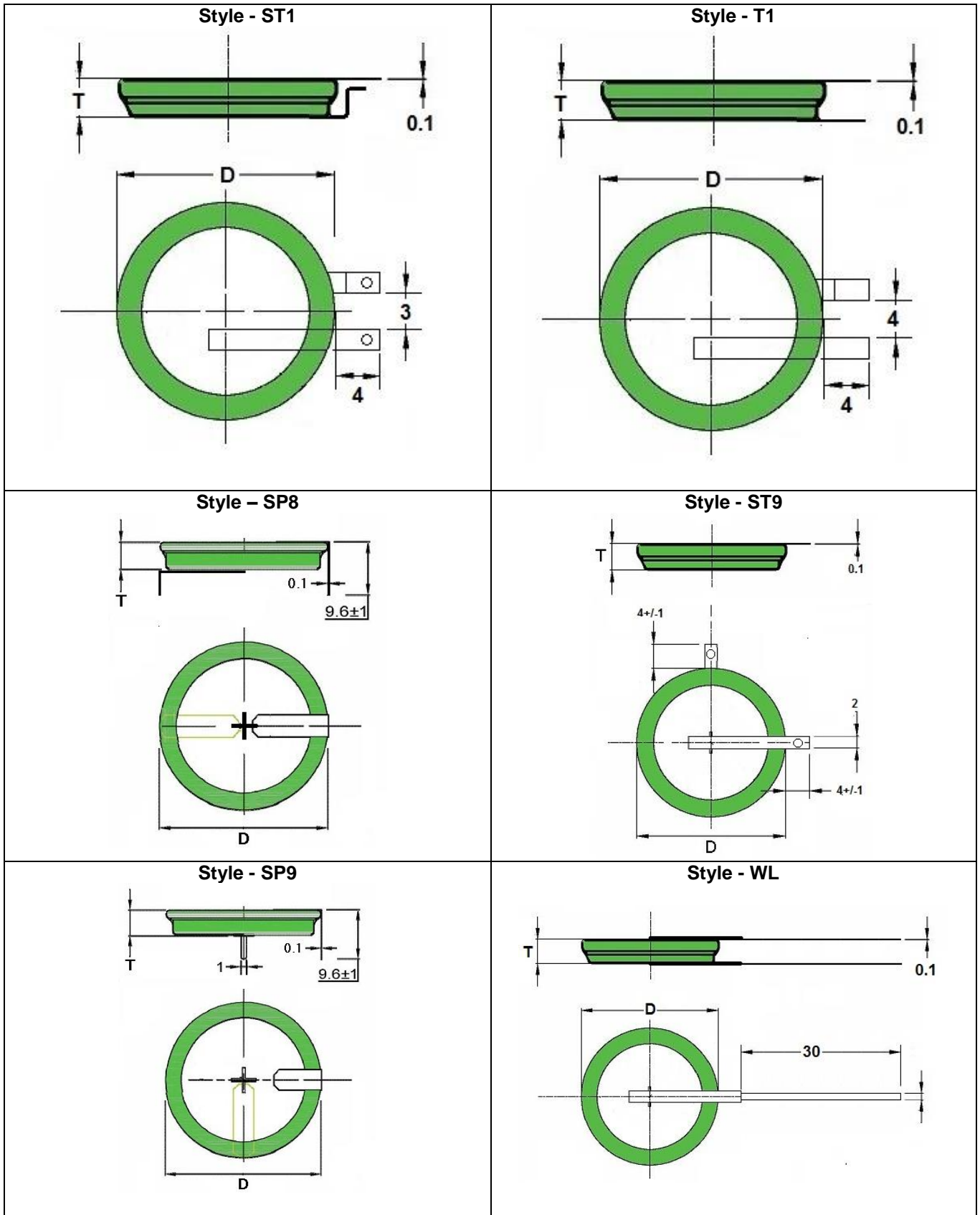

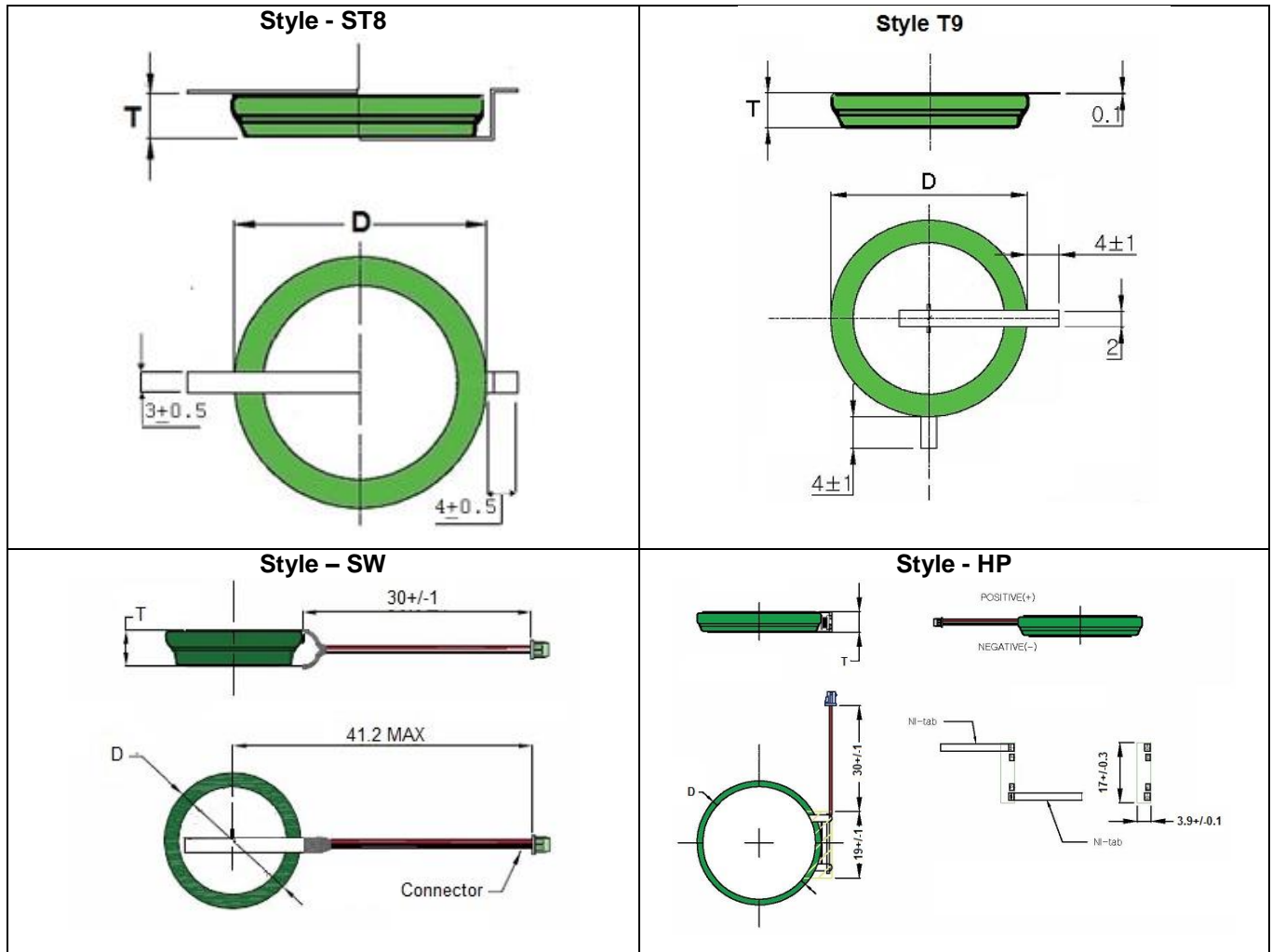

Contact IC if other termination type is preferred

**Section 3** – Connector supplied with PCM indicator, with connector is standard (Code P)

Connector with PCM	Connector without PCM
P	N

**Section 4** - Wire gauge for types SW and HP, 30 gauge is standard (Code V).

\*Contact IC if a different wire gauge is needed.

**Section 5** – Lead Length for types SW and HP, 30mm. is the standard. (Code 30)

\*Contact IC if a different wire length is needed.

**Section 6** – Connector option for types SW and HP, Molex is standard (Code M)





### Connector types

IC Code	M (Standard)	J
Connector Manufacturer	Molex	JST
Connector Part Number	51021-0200	ACHR-02V-S
Drawing		
Detailed specifications location	<a href="http://www.molex.com/pdm_docs/sd/51021_0200_sd.pdf">http://www.molex.com/pdm_docs/sd/51021_0200_sd.pdf</a>	<a href="http://www.jst.com/home23.html">http://www.jst.com/home23.html</a>

HP lead style are supplied with a PCM (Protection Circuit Module).  
 PCM Type: Powerlogics part # RJD 201 or RJD 9901 (see Protection Circuit Module section below for complete specifications).

#### PCM option

### Protection Circuit Module

(Only for HP lead style)

Specification	RJD 9901	RJD 201
PCM used with indicated corresponding bare cell part number	RJD3032 RJD3048 RJD3555	RJD2032C1, RJD2048, RJD2430C1, RJD2440, RJD2450
Main IC	SP31ABE	MP29A
PCB	SALTEK, APEX	SALTEK, APEX
FET	X	X
PTC	MicroSMD175F-2 (TE)	X
L terminal	X	X
Capacitor	2Point	2Point
Resistor	2Point	1Point
Dimension(L*W*T)	16.9*3.9*2.0mm	11.0X3.5X1.75mm
Wake-up Function	NO	NO
Overcharge Detection Voltage	4.275V ± 25mV	4.25V~4.3V
Overcharge Detection Delay Time	700.0mSec ~ 1300mSec	800.0mSec ~ 1200mSec
Over-Discharge Detection Voltage	2.242V~2.358V	2.76V~2.84V
Over-Discharge Detection Delay Time	14.0mSec~26.0mSec	16.0mSec~24.0mSec



Over-Discharge Current Detection	1.2 ~ 4.0A	0.77 ~ 1.76A
Overcharge Current Detection	0.9A ~ 4.4A	0.9A ~ 4.4A
Over-Discharge Current Protection Delay Time	8.0mSec ~ 16.0mSec	4.8mSec ~ 7.2mSec
Short Detection Delay Time	100μs ~ 500μs	280μs ~ 560μs
PCM Impedance	< 220mΩ	< 46mΩ
Operation Current Consumption	Max 6.0μA(TYP 4.0μA)	Max 6.0μA(TYP 3.0μA)
Power-Down Mode Current Consumption	Max 0.1μA	Max 0.1μA
Distance Between B+, B- Tab	13.93mm	5.25mm

### Battery Operation Instruction:

#### Charging

- Charge the battery in a temperature range of 0°C to + 45°C.
- Charge the battery at a constant current of 0.5C until 4.20VDC±0.03VDC per cell is attained. Charge rates greater than 1C are NOT recommended. (C: Rated Capacity of Battery)
- Maintain charge voltage at 4.20VDC per cell for 3.0 hours (recommended for maximum capacity).  
*\* Use a constant current, constant voltage (CC/CV) lithium-ion (Li+) battery charge controller.*  
*\* Do not continue to charge battery over specified time.*

#### Discharging

- Recommended cut-off voltage to 3.0VDC. Recommended maximum discharge rate is 2C at constant current.
- For maximum performance, discharge the battery in a temperature range of -20°C to + 45°C.

#### Protection Circuit

Protection circuit can be provided upon request. However, protection circuit may be omitted for most applications without damaging performance and safety. Please consult our engineering staff for technical advice.

#### Storage Recommendations

##### Storage Temperature and Humidity

Store the battery within a temperature range of -20°C to +45°C, low humidity, non-corrosive gas atmosphere and no condensation on the battery.

##### Long Period Storage

In case of a long storage period (more than 3 months), store the battery within a temperature range of -20°C to +25°C, low humidity and non-corrosive gas atmosphere. Extended storage periods will reduce the capacity of the battery.

##### Standard Test Conditions

Unless otherwise specified, all tests are conducted at 25°C ± 3°C and relative humidity of 65% ± 20%.



### Electrical Characteristics

#### Standard Charge and Discharge Conditions

- A. The "Standard Charge" means charging the Cell with initial charge current (0.5C) and with a constant voltage of 4.2VDC (+ 0.03VDC) and the specified cut-off current (see table 1) at 25°C for 3 hours.
- B. Standard discharge means discharging cell with constant discharge current (0.2C)(see table 1) and with 3.0VDC cut-off voltage at 25°C
- C. Initial Discharge Capacity
- D. The initial capacity measured under the standard test conditions
- E. Initial Discharge Capacity: See standard part listing
- F. Initial Internal resistance: see standard part listing
- G. Internal resistance measured at 1 kHz after Standard Charge.
- H. Cycle life (500 cycles with constant charge listed in note A above and constant discharge rate of 0.5C)
- I. Temperature dependence of discharge capacity. See discharge table below.
- J. Relative capacity at each temperature measured with a constant discharge current (0.2C) with 3.0VDC cutoff after the standard charge shown below.

IC Part Number	Discharge Temperature			
	-20°C	-10°C	25°C	60°C
RJD2032C1	>60 %	>80%	100 %	>95%
RJD2048	>60 %	>80%	100 %	>80%
RJD2430C1	>60 %	>80%	100 %	>95%
RJD2440	>60 %	>80%	100 %	>80%
RJD2450	>60 %	>80%	100 %	>80%
RJD3032	>60 %	>80%	100 %	>80%
RJD3048	>60 %	>80%	100 %	>80%
RJD3555	>60 %	>80%	100 %	>80%

**Table 1**

IC Part Number	Charging Current (0.5C) (mA)	Constant Discharge Current (0.2C) (mA)	Charging end condition (at CV mode) (mA)	Capacity after 500 cycles (mAh)
RJD2032C1	40	16	2.4	56
RJD2048	60	24	3.6	77
RJD2430C1	55	22	3.3	72.8
RJD2440	75	30	4.5	98
RJD2450	100	40	6	133
RJD3032	100	40	6	133
RJD3048	150	60	9	203
RJD3555	250	100	15	350





### Discharge Characteristics on Current Load (C-Rate)

Relative capacity at each load, measured with constant discharge current 0.2C, 0.5C, 1.0C, 2C with 3.0VDC cut-off after Standard Charge shown below.

Charge Current	Discharge Current			
Standard Charge	0.2 CA	0.5 CA	1 CA	2.0 CA
	100 %	> 95 %	> 90 %	> 50%

### Shipment

The Cell shall be shipped with 30% of the nominal voltage. (Nominal Cell voltage range: 3.7 ~ 3.8 V). 30% SOC is only for air transport.

### Storage Characteristics

After storage at the conditions listed below, the battery is measured at the standard charge and discharge conditions stated under the electrical characteristics.

Storage Condition	Charge State	Capacity Retention	Capacity Recovery
20 days at 60°C	Shipping charge	-	> 85%
20 days at 60°C	Full charge	> 70%	> 85%
60 days at 60°C	Full charge	> 40%	> 60%
30 days at 60°C, 90%RH	Full charge	> 40%	> 70%

### Safety Test

Test	Test Method	Criteria
High Temperature	Storing a cell at 90°C for 4 hours after being charged to 4.2VDC	No leakage
High Temperature and High Humidity	Storing a cell at 60°C and 90% RH for 1 week after being charged to 4.2VDC	No leakage
Thermal Shock Test	Store a fully charged cell (4.2VDC) at 60°C for 2 hours then at -20°C for 2 hours. 10 cycles with a maximum transition time of 5 minutes.	No leakage
Hot Box Test	A cell is to be heated in a gravity convection oven. The temperature of the oven is to be raised 5°C+/- 2°C per minute to a temperature of 130°C and remain at that temperature for 10 minutes	No explosion, No fire
Overcharge Test	Charge the test samples with constant current (3C) and voltage 4.5VDC. Test samples remain on test for 2.5 hours	No explosion, No fire
Impact Test	A test cell is to be placed on a flat surface. The bar of 9.1 kg weight and 15.8 mm diameter is dropped from a height of 610 mm onto the cell.	No explosion, No fire



Short-Circuit Test	A cell is to be short-circuited by connecting the positive and negative terminals of the battery with copper wire having a maximum resistance load of 100mΩ.	No fire or explosion, until battery is completely discharged
Nail Test	A stainless steel nail having a diameter of 4.0 mm is punched through the cell until the nail has passed through the opposite side of the cell.	No explosion, No fire
Applying Pressure	Placing pressure on entire surface of a fully charged cell with 7kg for 72 hours	No leakage, No weight decrease

### Precautions and Safety Instructions

Lithium-Ion rechargeable batteries subjected to abusive conditions can become damaged and/or cause personal injury. Please read and observe the standard battery precautions below before using.

**Note 1.** The customer is required to contact Illinois Capacitor in advance, if and when the customer needs other applications or operating conditions other than those described in this document.

**Note 2.** Illinois Capacitor will take no responsibility for any accident where the cell is used under other conditions than those described in this document.

### Precautions and Safety Instructions:

- a. Do not expose the battery to extreme heat or flame.
- b. Do not short circuit, over-charge or over-discharge the battery.
- c. Do not subject the battery to strong mechanical shocks.
- d. Do not immerse the battery in water or sea water, or get it wet.
- e. Do not reverse the polarity of the battery for any reason.
- f. Do not disassemble or modify the battery.
- g. Do not remove charge/discharge protection circuitry.
- h. Do not handle or store with metallic objects like necklaces, coins or hairpins, etc.
- i. Do not use the battery if possible damage or deformation is present.
- j. Do not connect battery to the plug socket or car-cigarette-plug.
- k. Do not directly solder onto the battery. Only spot weld lead onto battery. Soldering iron temperature should be limited to 350°C with a soldering time of <5 seconds.
- l. Do not place batteries in a solder bath.
- m. Do not touch a leaked battery directly.
- n. Do not use for other equipment.
- o. Do not mix Lithium-ion batteries.
- p. Do not use or leave the battery in direct sunlight (or in heated car by sunshine).
- q. Keep battery away from children.
- r. Use only the specified charger and observe charging requirement.
- s. Do not drive a nail into battery or strike battery with another battery or insert a screw into the battery
- t. Do not smash or throw battery.
- u. Recharge the battery every 6 months.
- v. Follow recommended charging conditions when charging battery.



### Warnings:

- a. Do not swallow. Keep out of reach of infants and children. If swallowed call physician immediately.
- b. Do not put battery in microwave or pressure cooker.
- c. Do not use battery together with a primary battery, such as dry battery types or batteries with different capacities.
- d. Do not replace battery with a different type or model.
- e. Discontinue use of battery if an unusual odor, discoloration, deformation, internal heating or other unusual characteristic changes are detected.
- f. Do not have any leaked electrolyte come in contact with eyes. If contact occurs flush eyes immediately with water and consult a doctor.
- g. If charging does not stop after expected charging time, stop charging battery.

### Requirement for Safety Assurance

For safety assurance, please discuss the equipment design, its system and protection circuit of Lithium-ion battery with Illinois capacitor in advance.

Consult with Illinois Capacitor about high rate current, rapid charge and special application.

Компания «Life Electronics» занимается поставками электронных компонентов импортного и отечественного производства от производителей и со складов крупных дистрибьюторов Европы, Америки и Азии.

С конца 2013 года компания активно расширяет линейку поставок компонентов по направлению коаксиальный кабель, кварцевые генераторы и конденсаторы (керамические, пленочные, электролитические), за счёт заключения дистрибьюторских договоров

Мы предлагаем:

- Конкурентоспособные цены и скидки постоянным клиентам.
- Специальные условия для постоянных клиентов.
- Подбор аналогов.
- Поставку компонентов в любых объемах, удовлетворяющих вашим потребностям.
- Приемлемые сроки поставки, возможна ускоренная поставка.
- Доставку товара в любую точку России и стран СНГ.
- Комплексную поставку.
- Работу по проектам и поставку образцов.
- Формирование склада под заказчика.
- Сертификаты соответствия на поставляемую продукцию (по желанию клиента).
- Тестирование поставляемой продукции.
- Поставку компонентов, требующих военную и космическую приемку.
- Входной контроль качества.
- Наличие сертификата ISO.

В составе нашей компании организован Конструкторский отдел, призванный помогать разработчикам, и инженерам.

Конструкторский отдел помогает осуществить:

- Регистрацию проекта у производителя компонентов.
- Техническую поддержку проекта.
- Защиту от снятия компонента с производства.
- Оценку стоимости проекта по компонентам.
- Изготовление тестовой платы монтаж и пусконаладочные работы.



Тел: +7 (812) 336 43 04 (многоканальный)

Email: [org@lifeelectronics.ru](mailto:org@lifeelectronics.ru)