

### FEATURES

- Isolated PWM controller
- Integrated transformer driver
- Regulated adjustable output: 3.3 V to 24 V
- 2 W output power
- 70% efficiency at guaranteed load of 400 mA at 5.0 V output
- Quad dc-to-25 Mbps (NRZ) signal isolation channels
- 20-lead SSOP package
- High temperature operation: 105°C maximum
- High common-mode transient immunity: >25 kV/μs
- 200 kHz to 1 MHz adjustable oscillator frequency
- Soft start function at power-up
- Pulse-by-pulse overcurrent protection
- Thermal shutdown
- Safety and regulatory approvals**
  - UL recognition: 2500 V rms for 1 minute per UL 1577
  - CSA Component Acceptance Notice #5A
  - VDE certificate of conformity
  - DIN V VDE V 0884-10 (VDE V 0884-10):2006-12
  - $V_{IORM} = 560$  V peak

Qualified for automotive applications

### APPLICATIONS

- RS-232/RS-422/RS-485 transceivers
- Industrial field bus isolation
- Power supply start-up bias and gate drives
- Isolated sensor interfaces
- Process controls
- Automotive

### GENERAL DESCRIPTION

The ADuM3470/ADuM3471/ADuM3472/ADuM3473/ADuM3474 devices<sup>1</sup> are quad-channel digital isolators with an integrated PWM controller and transformer driver for an isolated dc-to-dc converter. Based on the Analog Devices, Inc., iCoupler® technology, the dc-to-dc converter provides up to 2 W of regulated, isolated power at 3.3 V to 24 V from a 5.0 V input supply or from a 3.3 V supply. This eliminates the need for a separate, isolated dc-to-dc converter in 2 W isolated designs. The iCoupler chip scale transformer technology is used to isolate the logic signals, and the integrated transformer driver with isolated secondary side control provides higher efficiency for the isolated dc-to-dc converter. The result is a small form factor, total isolation solution. The ADuM347x isolators provide four independent isolation channels in a variety of channel configurations and data rates (see the Ordering Guide).

<sup>1</sup> Protected by U.S. Patents 5,952,849; 6,873,065; and 7,075,329. Other patents pending.

**Rev. B** **Document Feedback**  
 Information furnished by Analog Devices is believed to be accurate and reliable. However, no responsibility is assumed by Analog Devices for its use, nor for any infringements of patents or other rights of third parties that may result from its use. Specifications subject to change without notice. No license is granted by implication or otherwise under any patent or patent rights of Analog Devices. Trademarks and registered trademarks are the property of their respective owners.

### FUNCTIONAL BLOCK DIAGRAMS

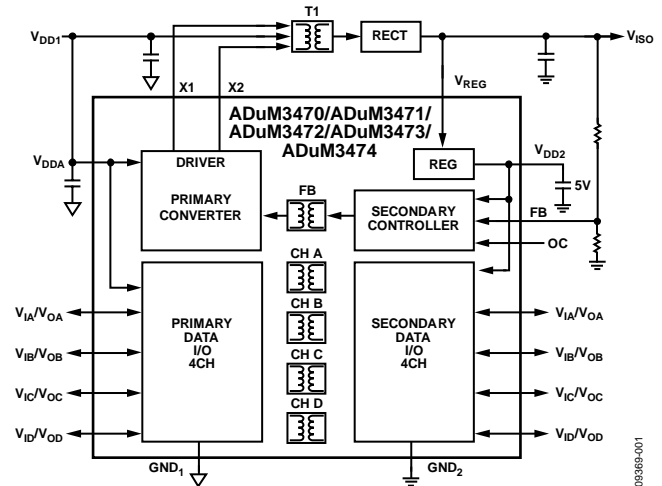

Figure 1. Functional Block Diagram



Figure 2. Block Diagrams of I/O Channels

## TABLE OF CONTENTS

Features .....	1	Typical Performance Characteristics .....	19
Applications.....	1	Terminology.....	24
General Description.....	1	Applications Information.....	25
Functional Block Diagrams.....	1	Application Schematics .....	25
Revision History .....	2	Transformer Design .....	26
Specifications.....	3	Transformer Turns Ratio.....	26
Electrical Characteristics—5 V Primary Input Supply/ 5 V Secondary Isolated Supply .....	3	Transformer ET Constant .....	27
Electrical Characteristics—3.3 V Primary Input Supply/ 3.3 V Secondary Isolated Supply .....	5	Transformer Primary Inductance and Resistance .....	27
Electrical Characteristics—5 V Primary Input Supply/ 3.3 V Secondary Isolated Supply .....	7	Transformer Isolation Voltage.....	27
Electrical Characteristics—5 V Primary Input Supply/ 15 V Secondary Isolated Supply .....	9	Switching Frequency.....	27
Package Characteristics .....	11	Transient Response .....	27
Regulatory Approvals.....	11	Component Selection .....	27
Insulation and Safety-Related Specifications.....	11	Printed Circuit Board (PCB) Layout.....	28
DIN V VDE V 0884-10 (VDE V 0884-10):2006-12		Thermal Analysis .....	28
Insulation Characteristics.....	12	Propagation Delay-Related Parameters.....	28
Recommended Operating Conditions .....	12	DC Correctness and Magnetic Field Immunity.....	29
Absolute Maximum Ratings.....	13	Power Consumption .....	30
ESD Caution.....	13	Power Considerations.....	30
Pin Configurations and Function Descriptions .....	14	Insulation Lifetime.....	31
		Outline Dimensions .....	32
		Ordering Guide .....	33
		Automotive Products.....	33

## REVISION HISTORY

### 5/14—Rev. A to Rev. B

Change to Table 4 .....	9
-------------------------	---

### 7/13—Rev. 0 to Rev. A

Changed V <sub>DD1</sub> Pin to NC Pin .....	Throughout
Changes to Features Section, Applications Section, General Description Section, and Figure 1 .....	1
Created Hyperlink for Safety and Regulatory Approvals Entry in Features Section.....	1
Changes to Table 1.....	3
Changes to Table 2.....	5
Changes to Table 3.....	7
Changes to Table 4.....	9
Changes to Regulatory Approvals Section .....	11
Changes to Figure 3 and Table 9.....	12
Changes to Figure 4 and Table 12.....	14
Changes to Figure 5 and Table 13.....	15

Changes to Figure 6 and Table 14.....	16
Changes to Figure 7 and Table 15.....	17
Changes to Figure 8, Table 16, and Table 17.....	18
Change to Figure 9 .....	19
Changes to Terminology Section .....	24
Changes to Applications Information Section, Application Schematics Section, Figure 38, Figure 39, and Figure 40 .....	25
Changes to Transformer Turns Ratio Section .....	26
Changes to Transformer ET Constant Section, Transient Response Section, and Table 19 .....	27
Changes to Figure 41.....	28
Changes to Power Consumption Section and Figure 45.....	30
Changes to Insulation Lifetime Section and Figure 48 .....	31
Changes to Ordering Guide .....	33
Added Automotive Products Section .....	33

### 10/10—Revision 0: Initial Version

## SPECIFICATIONS

## ELECTRICAL CHARACTERISTICS—5 V PRIMARY INPUT SUPPLY/5 V SECONDARY ISOLATED SUPPLY

$4.5\text{ V} \leq V_{DD1} = V_{DDA} \leq 5.5\text{ V}$ ;  $V_{DD2} = V_{REG} = V_{ISO} = 5.0\text{ V}$ ;  $f_{SW} = 500\text{ kHz}$ ; all voltages are relative to their respective grounds (see the application schematic in Figure 38). All minimum/maximum specifications apply over the entire recommended operating range, unless otherwise noted. All typical specifications are at  $T_A = 25^\circ\text{C}$ ,  $V_{DD1} = V_{DDA} = 5.0\text{ V}$ ,  $V_{DD2} = V_{REG} = V_{ISO} = 5.0\text{ V}$ .

Table 1.

Parameter	Symbol	Min	Typ	Max	Unit	Test Conditions/Comments
<b>DC-TO-DC CONVERTER POWER SUPPLY</b>						
Isolated Output Voltage	$V_{ISO}$	4.5	5.0	5.5	V	$I_{ISO} = 0\text{ mA}$ , $V_{ISO} = V_{FB} \times (R1 + R2)/R2$
Feedback Voltage Setpoint	$V_{FB}$	1.125	1.25	1.375	V	$I_{ISO} = 0\text{ mA}$
Line Regulation	$V_{ISO(LINE)}$		1	10	mV/V	$I_{ISO} = 50\text{ mA}$ , $V_{DD1} = 4.5\text{ V to } 5.5\text{ V}$
Load Regulation	$V_{ISO(LOAD)}$		1	2	%	$I_{ISO} = 50\text{ mA to } 200\text{ mA}$
Output Ripple	$V_{ISO(RIP)}$		50		mV p-p	20 MHz bandwidth, $C_{OUT} = 0.1\text{ }\mu\text{F}  47\text{ }\mu\text{F}$ , $I_{ISO} = 100\text{ mA}$
Output Noise	$V_{ISO(N)}$		100		mV p-p	20 MHz bandwidth, $C_{OUT} = 0.1\text{ }\mu\text{F}  47\text{ }\mu\text{F}$ , $I_{ISO} = 100\text{ mA}$
Switching Frequency	$f_{SW}$		1000		kHz	$R_{OC} = 50\text{ k}\Omega$
			200		kHz	$R_{OC} = 270\text{ k}\Omega$
		192	318	515	kHz	$V_{OC} = V_{DD2}$ (open loop)
Switch On Resistance	$R_{ON}$		0.5		$\Omega$	
Undervoltage Lockout, $V_{DD1}$ , $V_{DD2}$ Supplies						
Positive Going Threshold	$V_{UV+}$		2.8		V	
Negative Going Threshold	$V_{UV-}$		2.6		V	
Hysteresis	$V_{UVH}$		0.2		V	
DC to 2 Mbps Data Rate <sup>1</sup>						$f \leq 1\text{ MHz}$
Maximum Output Supply Current <sup>2</sup>	$I_{ISO(MAX)}$	400			mA	$V_{ISO} = 5.0\text{ V}$
Efficiency at Maximum Output Supply Current <sup>3</sup>			70		%	$I_{ISO} = I_{ISO(MAX)}$
<b>iCOUPLER DATA CHANNELS</b>						
DC to 2 Mbps Data Rate <sup>1</sup>						
$I_{DD1}$ Supply Current, No $V_{ISO}$ Load	$I_{DD1(Q)}$					$I_{ISO} = 0\text{ mA}$ , $f \leq 1\text{ MHz}$
ADuM3470			14	30	mA	
ADuM3471			15	30	mA	
ADuM3472			16	30	mA	
ADuM3473			17	30	mA	
ADuM3474			18	30	mA	
25 Mbps Data Rate (C Grade Only)						
$I_{DD1}$ Supply Current, No $V_{ISO}$ Load	$I_{DD1(D)}$					$I_{ISO} = 0\text{ mA}$ , $C_L = 15\text{ pF}$ , $f = 12.5\text{ MHz}$
ADuM3470			44		mA	
ADuM3471			46		mA	
ADuM3472			48		mA	
ADuM3473			50		mA	
ADuM3474			52		mA	
Available $V_{ISO}$ Supply Current <sup>4</sup>	$I_{ISO(LOAD)}$					$C_L = 15\text{ pF}$ , $f = 12.5\text{ MHz}$
ADuM3470			390		mA	
ADuM3471			388		mA	
ADuM3472			386		mA	
ADuM3473			384		mA	
ADuM3474			382		mA	
$I_{DD1}$ Supply Current, Full $V_{ISO}$ Load	$I_{DD1(MAX)}$		550		mA	$C_L = 0\text{ pF}$ , $f = 0\text{ MHz}$ , $V_{DD1} = 5\text{ V}$ , $I_{ISO} = 400\text{ mA}$

Parameter	Symbol	Min	Typ	Max	Unit	Test Conditions/Comments
I/O Input Currents	$I_{IA}, I_{IB}, I_{IC}, I_{ID}$	-20	+0.01	+20	$\mu\text{A}$	
Logic High Input Threshold	$V_{IH}$	2.0			V	
Logic Low Input Threshold	$V_{IL}$			0.8	V	
Logic High Output Voltages	$V_{OAH}, V_{OBH}, V_{OCH}, V_{ODH}$	$V_{DD1} - 0.3,$ $V_{ISO} - 0.3$	5.0		V	$I_{OX} = -20 \mu\text{A}, V_{IX} = V_{IXH}$
		$V_{DD1} - 0.5,$ $V_{ISO} - 0.5$	4.8		V	$I_{OX} = -4 \text{ mA}, V_{IX} = V_{IXH}$
Logic Low Output Voltages	$V_{OAL}, V_{OBL}, V_{OCL}, V_{ODL}$		0.0	0.1	V	$I_{OX} = 20 \mu\text{A}, V_{IX} = V_{IXL}$
			0.0	0.4	V	$I_{OX} = 4 \text{ mA}, V_{IX} = V_{IXL}$
<b>AC SPECIFICATIONS</b>						
<b>A Grade</b>						
Minimum Pulse Width	PW			1000	ns	$C_L = 15 \text{ pF}$ , CMOS signal levels
Maximum Data Rate		1			Mbps	
Propagation Delay	$t_{PHL}, t_{PLH}$		55	100	ns	
Pulse Width Distortion, $ t_{PLH} - t_{PHL} $	PWD			40	ns	
Propagation Delay Skew	$t_{PSK}$			50	ns	
Channel-to-Channel Matching	$t_{PSKCD}/t_{PSKOD}$			50	ns	
<b>C Grade</b>						
Minimum Pulse Width	PW			40	ns	$C_L = 15 \text{ pF}$ , CMOS signal levels
Maximum Data Rate		25			Mbps	
Propagation Delay	$t_{PHL}, t_{PLH}$	30	45	60	ns	
Pulse Width Distortion, $ t_{PLH} - t_{PHL} $	PWD			8	ns	
Change vs. Temperature			5		ps/ $^{\circ}\text{C}$	
Propagation Delay Skew	$t_{PSK}$			15	ns	
Channel-to-Channel Matching						
Codirectional Channels	$t_{PSKCD}$			8	ns	
Opposing Directional Channels	$t_{PSKOD}$			15	ns	
Output Rise/Fall Time (10% to 90%)	$t_R/t_F$		2.5		ns	$C_L = 15 \text{ pF}$ , CMOS signal levels
Common-Mode Transient Immunity						$V_{CM} = 1000 \text{ V}$ , transient magnitude = 800 V
At Logic High Output	$ CM_H $	25	35		kV/ $\mu\text{s}$	$V_{IX} = V_{DD1}$ or $V_{ISO}$
At Logic Low Output	$ CM_L $	25	35		kV/ $\mu\text{s}$	$V_{IX} = 0 \text{ V}$
Refresh Rate	$f_r$		1.0		Mbps	

<sup>1</sup> The contributions of supply current values for all four channels are combined at identical data rates.

<sup>2</sup> The  $V_{ISO}$  supply current is available for external use when all data rates are below 2 Mbps. At data rates above 2 Mbps, the data I/O channels draw additional current proportional to the data rate. Additional supply current associated with an individual channel operating at a given data rate can be calculated as described in the Power Consumption section. The dynamic I/O channel load must be treated as an external load and included in the  $V_{ISO}$  power budget.

<sup>3</sup> The power demands of the quiescent operation of the data channels is not separated from the power supply section. Efficiency includes the quiescent power consumed by the I/O channels as part of the internal power consumption.

<sup>4</sup> This current is available for driving external loads at the  $V_{ISO}$  output. All channels are simultaneously driven at a maximum data rate of 25 Mbps with full capacitive load representing the maximum dynamic load conditions. Refer to the Power Consumption section for calculation of the available current at less than the maximum data rate.

**ELECTRICAL CHARACTERISTICS—3.3 V PRIMARY INPUT SUPPLY/3.3 V SECONDARY ISOLATED SUPPLY**

$3.0\text{ V} \leq V_{DD1} = V_{DDA} \leq 3.6\text{ V}$ ;  $V_{DD2} = V_{REG} = V_{ISO} = 3.3\text{ V}$ ;  $f_{SW} = 500\text{ kHz}$ ; all voltages are relative to their respective grounds (see the application schematic in Figure 38). All minimum/maximum specifications apply over the entire recommended operating range, unless otherwise noted. All typical specifications are at  $T_A = 25^\circ\text{C}$ ,  $V_{DD1} = V_{DDA} = 3.3\text{ V}$ ,  $V_{DD2} = V_{REG} = V_{ISO} = 3.3\text{ V}$ .

**Table 2.**

Parameter	Symbol	Min	Typ	Max	Unit	Test Conditions/Comments
<b>DC-TO-DC CONVERTER POWER SUPPLY</b>						
Isolated Output Voltage	$V_{ISO}$	3.0	3.3	3.6	V	$I_{ISO} = 0\text{ mA}$ , $V_{ISO} = V_{FB} \times (R1 + R2)/R2$
Feedback Voltage Setpoint	$V_{FB}$	1.125	1.25	1.375	V	$I_{ISO} = 0\text{ mA}$
Line Regulation	$V_{ISO(LINE)}$		1	10	mV/V	$I_{ISO} = 50\text{ mA}$ , $V_{DD1} = 3.0\text{ V to }3.6\text{ V}$
Load Regulation	$V_{ISO(LOAD)}$		1	2	%	$I_{ISO} = 20\text{ mA to }100\text{ mA}$
Output Ripple	$V_{ISO(RIP)}$		50		mV p-p	20 MHz bandwidth, $C_{OUT} = 0.1\text{ }\mu\text{F}  47\text{ }\mu\text{F}$ , $I_{ISO} = 100\text{ mA}$
Output Noise	$V_{ISO(N)}$		100		mV p-p	20 MHz bandwidth, $C_{OUT} = 0.1\text{ }\mu\text{F}  47\text{ }\mu\text{F}$ , $I_{ISO} = 100\text{ mA}$
Switching Frequency	$f_{SW}$		1000		kHz	$R_{OC} = 50\text{ k}\Omega$
			200		kHz	$R_{OC} = 270\text{ k}\Omega$
		192	318	515	kHz	$V_{OC} = V_{DD2}$ (open loop)
Switch On Resistance	$R_{ON}$		0.6		$\Omega$	
Undervoltage Lockout, $V_{DD1}$ , $V_{DD2}$ Supplies						
Positive Going Threshold	$V_{UV+}$		2.8		V	
Negative Going Threshold	$V_{UV-}$		2.6		V	
Hysteresis	$V_{UVH}$		0.2		V	
DC to 2 Mbps Data Rate <sup>1</sup>						$f \leq 1\text{ MHz}$ ,
Maximum Output Supply Current <sup>2</sup>	$I_{ISO(MAX)}$	250			mA	$V_{ISO} = 3.3\text{ V}$
Efficiency at Maximum Output Supply Current <sup>3</sup>			70		%	$I_{ISO} = I_{ISO(MAX)}$
<b>iCOUPLER DATA CHANNELS</b>						
DC to 2 Mbps Data Rate <sup>1</sup>						
$I_{DD1}$ Supply Current, No $V_{ISO}$ Load	$I_{DD1(Q)}$					$I_{ISO} = 0\text{ mA}$ , $f \leq 1\text{ MHz}$
ADuM3470			9	20	mA	
ADuM3471			10	20	mA	
ADuM3472			11	20	mA	
ADuM3473			11	20	mA	
ADuM3474			12	20	mA	
25 Mbps Data Rate (C Grade Only)						
$I_{DD1}$ Supply Current, No $V_{ISO}$ Load	$I_{DD1(D)}$					$I_{ISO} = 0\text{ mA}$ , $C_L = 15\text{ pF}$ , $f = 12.5\text{ MHz}$
ADuM3470			28		mA	
ADuM3471			29		mA	
ADuM3472			31		mA	
ADuM3473			32		mA	
ADuM3474			34		mA	
Available $V_{ISO}$ Supply Current <sup>4</sup>	$I_{ISO(LOAD)}$					$C_L = 15\text{ pF}$ , $f = 12.5\text{ MHz}$
ADuM3470			244		mA	
ADuM3471			243		mA	
ADuM3472			241		mA	
ADuM3473			240		mA	
ADuM3474			238		mA	
$I_{DD1}$ Supply Current, Full $V_{ISO}$ Load	$I_{DD1(MAX)}$		350		mA	$C_L = 0\text{ pF}$ , $f = 0\text{ MHz}$ , $V_{DD1} = 3.3\text{ V}$ , $I_{ISO} = 250\text{ mA}$
I/O Input Currents	$I_{IA}$ , $I_{IB}$ , $I_{IC}$ , $I_{ID}$	-10	+0.01	+10	$\mu\text{A}$	

Parameter	Symbol	Min	Typ	Max	Unit	Test Conditions/Comments
Logic High Input Threshold	$V_{IH}$	1.6			V	
Logic Low Input Threshold	$V_{IL}$			0.4	V	
Logic High Output Voltages	$V_{OAH}, V_{OBH}, V_{OCH}, V_{ODH}$	$V_{DD1} - 0.3,$ $V_{ISO} - 0.3$	5.0		V	$I_{Ox} = -20 \mu A, V_{ix} = V_{ixH}$
		$V_{DD1} - 0.5,$ $V_{ISO} - 0.5$	4.8		V	$I_{Ox} = -4 \text{ mA}, V_{ix} = V_{ixH}$
Logic Low Output Voltages	$V_{OAL}, V_{OBL}, V_{OCL}, V_{ODL}$		0.0	0.1	V	$I_{Ox} = 20 \mu A, V_{ix} = V_{ixL}$
			0.0	0.4	V	$I_{Ox} = 4 \text{ mA}, V_{ix} = V_{ixL}$
<b>AC SPECIFICATIONS</b>						
<b>A Grade</b>						
Minimum Pulse Width	PW			1000	ns	$C_L = 15 \text{ pF}$ , CMOS signal levels
Maximum Data Rate		1			Mbps	
Propagation Delay	$t_{PHL}, t_{PLH}$		60	100	ns	
Pulse Width Distortion, $ t_{PLH} - t_{PHL} $	PWD			40	ns	
Propagation Delay Skew	$t_{PSK}$			50	ns	
Channel-to-Channel Matching	$t_{PSKCD}/t_{PSKOD}$			50	ns	
<b>C Grade</b>						
Minimum Pulse Width	PW			40	ns	$C_L = 15 \text{ pF}$ , CMOS signal levels
Maximum Data Rate		25			Mbps	
Propagation Delay	$t_{PHL}, t_{PLH}$	30	60	75	ns	
Pulse Width Distortion, $ t_{PLH} - t_{PHL} $	PWD			8	ns	
Change vs. Temperature			5		ps/°C	
Propagation Delay Skew	$t_{PSK}$			45	ns	
Channel-to-Channel Matching						
Codirectional Channels	$t_{PSKCD}$			8	ns	
Opposing Directional Channels	$t_{PSKOD}$			15	ns	
Output Rise/Fall Time (10% to 90%)	$t_R/t_F$		2.5		ns	$C_L = 15 \text{ pF}$ , CMOS signal levels
Common-Mode Transient Immunity						$V_{CM} = 1000 \text{ V}$ , transient magnitude = 800 V
At Logic High Output	$ CM_H $	25	35		kV/ $\mu$ s	$V_{ix} = V_{DD1}$ or $V_{ISO}$
At Logic Low Output	$ CM_L $	25	35		kV/ $\mu$ s	$V_{ix} = 0 \text{ V}$
Refresh Rate	$f_r$		1.0		Mbps	

<sup>1</sup> The contributions of supply current values for all four channels are combined at identical data rates.

<sup>2</sup> The  $V_{ISO}$  supply current is available for external use when all data rates are below 2 Mbps. At data rates above 2 Mbps, the data I/O channels draw additional current proportional to the data rate. Additional supply current associated with an individual channel operating at a given data rate can be calculated as described in the Power Consumption section. The dynamic I/O channel load must be treated as an external load and included in the  $V_{ISO}$  power budget.

<sup>3</sup> The power demands of the quiescent operation of the data channels is not separated from the power supply section. Efficiency includes the quiescent power consumed by the I/O channels as part of the internal power consumption.

<sup>4</sup> This current is available for driving external loads at the  $V_{ISO}$  output. All channels are simultaneously driven at a maximum data rate of 25 Mbps with full capacitive load representing the maximum dynamic load conditions. Refer to the Power Consumption section for calculation of the available current at less than the maximum data rate.

**ELECTRICAL CHARACTERISTICS—5 V PRIMARY INPUT SUPPLY/3.3 V SECONDARY ISOLATED SUPPLY**

$4.5\text{ V} \leq V_{DD1} = V_{DDA} \leq 5.5\text{ V}$ ;  $V_{DD2} = V_{REG} = V_{ISO} = 3.3\text{ V}$ ;  $f_{SW} = 500\text{ kHz}$ ; all voltages are relative to their respective grounds (see the application schematic in Figure 38). All minimum/maximum specifications apply over the entire recommended operating range, unless otherwise noted. All typical specifications are at  $T_A = 25^\circ\text{C}$ ,  $V_{DD1} = V_{DDA} = 5.0\text{ V}$ ,  $V_{DD2} = V_{REG} = V_{ISO} = 3.3\text{ V}$ .

**Table 3.**

Parameter	Symbol	Min	Typ	Max	Unit	Test Conditions/Comments
<b>DC-TO-DC CONVERTER POWER SUPPLY</b>						
Isolated Output Voltage	$V_{ISO}$	3.0	3.3	3.6	V	$I_{ISO} = 0\text{ mA}$ , $V_{ISO} = V_{FB} \times (R1 + R2)/R2$
Feedback Voltage Setpoint	$V_{FB}$	1.125	1.25	1.375	V	$I_{ISO} = 0\text{ mA}$
Line Regulation	$V_{ISO(LINE)}$		1	10	mV/V	$I_{ISO} = 50\text{ mA}$ , $V_{DD1} = 4.5\text{ V to }5.5\text{ V}$
Load Regulation	$V_{ISO(LOAD)}$		1	2	%	$I_{ISO} = 50\text{ mA to }200\text{ mA}$
Output Ripple	$V_{ISO(RIP)}$		50		mV p-p	20 MHz bandwidth, $C_{OUT} = 0.1\text{ }\mu\text{F}  47\text{ }\mu\text{F}$ , $I_{ISO} = 100\text{ mA}$
Output Noise	$V_{ISO(N)}$		100		mV p-p	20 MHz bandwidth, $C_{OUT} = 0.1\text{ }\mu\text{F}  47\text{ }\mu\text{F}$ , $I_{ISO} = 100\text{ mA}$
Switching Frequency	$f_{SW}$		1000		kHz	$R_{OC} = 50\text{ k}\Omega$
			200		kHz	$R_{OC} = 270\text{ k}\Omega$
		192	318	515	kHz	$V_{OC} = V_{DD2}$ (open loop)
Switch On Resistance	$R_{ON}$		0.5		$\Omega$	
Undervoltage Lockout, $V_{DD1}$ , $V_{DD2}$ Supplies						
Positive Going Threshold	$V_{UV+}$		2.8		V	
Negative Going Threshold	$V_{UV-}$		2.6		V	
Hysteresis	$V_{UVH}$		0.2		V	
DC to 2 Mbps Data Rate <sup>1</sup>						$f \leq 1\text{ MHz}$
Maximum Output Supply Current <sup>2</sup>	$I_{ISO(MAX)}$	400			mA	$V_{ISO} = 3.3\text{ V}$
Efficiency at Maximum Output Supply Current <sup>3</sup>			70		%	$I_{ISO} = I_{ISO(MAX)}$
<b>iCOUPLER DATA CHANNELS</b>						
DC to 2 Mbps Data Rate <sup>1</sup>						
$I_{DD1}$ Supply Current, No $V_{ISO}$ Load	$I_{DD1(Q)}$					$I_{ISO} = 0\text{ mA}$ , $f \leq 1\text{ MHz}$
ADuM3470			9	30	mA	
ADuM3471			9	30	mA	
ADuM3472			10	30	mA	
ADuM3473			10	30	mA	
ADuM3474			10	30	mA	
25 Mbps Data Rate (C Grade Only)						
$I_{DD1}$ Supply Current, No $V_{ISO}$ Load	$I_{DD1(D)}$					$I_{ISO} = 0\text{ mA}$ , $C_L = 15\text{ pF}$ , $f = 12.5\text{ MHz}$
ADuM3470			33		mA	
ADuM3471			33		mA	
ADuM3472			33		mA	
ADuM3473			33		mA	
ADuM3474			33		mA	
Available $V_{ISO}$ Supply Current <sup>4</sup>	$I_{ISO(LOAD)}$					$C_L = 15\text{ pF}$ , $f = 12.5\text{ MHz}$
ADuM3470			393		mA	
ADuM3471			392		mA	
ADuM3472			390		mA	
ADuM3473			389		mA	
ADuM3474			388		mA	
$I_{DD1}$ Supply Current, Full $V_{ISO}$ Load	$I_{DD1(MAX)}$		375		mA	$C_L = 0\text{ pF}$ , $f = 0\text{ MHz}$ , $V_{DD1} = 5\text{ V}$ , $I_{ISO} = 400\text{ mA}$
I/O Input Currents	$I_{IA}$ , $I_{IB}$ , $I_{IC}$ , $I_{ID}$	-20	+0.01	+20	$\mu\text{A}$	

Parameter	Symbol	Min	Typ	Max	Unit	Test Conditions/Comments
Logic High Input Threshold	$V_{IH}$	2.0			V	
Logic Low Input Threshold	$V_{IL}$			0.8	V	
Logic High Output Voltages	$V_{OAH}, V_{OBH}, V_{OCH}, V_{ODH}$	$V_{DD1} - 0.3,$ $V_{ISO} - 0.3$	5.0		V	$I_{Ox} = -20 \mu A, V_{Ix} = V_{IxH}$
		$V_{DD1} - 0.5,$ $V_{ISO} - 0.5$	4.8		V	$I_{Ox} = -4 \text{ mA}, V_{Ix} = V_{IxH}$
Logic Low Output Voltages	$V_{OAL}, V_{OBL}, V_{OCL}, V_{ODL}$		0.0	0.1	V	$I_{Ox} = 20 \mu A, V_{Ix} = V_{IxL}$
			0.0	0.4	V	$I_{Ox} = 4 \text{ mA}, V_{Ix} = V_{IxL}$
<b>AC SPECIFICATIONS</b>						
<b>A Grade</b>						
Minimum Pulse Width	PW			1000	ns	$C_L = 15 \text{ pF}$ , CMOS signal levels
Maximum Data Rate		1			Mbps	
Propagation Delay	$t_{PHL}, t_{PLH}$		55	100	ns	
Pulse Width Distortion, $ t_{PLH} - t_{PHL} $	PWD			40	ns	
Propagation Delay Skew	$t_{PSK}$			50	ns	
Channel-to-Channel Matching	$t_{PSKCD}/t_{PSKOD}$			50	ns	
<b>C Grade</b>						
Minimum Pulse Width	PW			40	ns	$C_L = 15 \text{ pF}$ , CMOS signal levels
Maximum Data Rate		25			Mbps	
Propagation Delay	$t_{PHL}, t_{PLH}$	30	50	70	ns	
Pulse Width Distortion, $ t_{PLH} - t_{PHL} $	PWD			8	ns	
Change vs. Temperature			5		ps/ $^{\circ}C$	
Propagation Delay Skew	$t_{PSK}$			15	ns	
Channel-to-Channel Matching						
Codirectional Channels	$t_{PSKCD}$			8	ns	
Opposing Directional Channels	$t_{PSKOD}$			15	ns	
Output Rise/Fall Time (10% to 90%)	$t_R/t_F$		2.5		ns	$C_L = 15 \text{ pF}$ , CMOS signal levels
Common-Mode Transient Immunity						$V_{CM} = 1000 \text{ V}$ , transient magnitude = 800 V
At Logic High Output	$ CM_H $	25	35		kV/ $\mu s$	$V_{Ix} = V_{DD1}$ or $V_{ISO}$
At Logic Low Output	$ CM_L $	25	35		kV/ $\mu s$	$V_{Ix} = 0 \text{ V}$
Refresh Rate	$f_r$		1.0		Mbps	

<sup>1</sup> The contributions of supply current values for all four channels are combined at identical data rates.

<sup>2</sup> The  $V_{ISO}$  supply current is available for external use when all data rates are below 2 Mbps. At data rates above 2 Mbps, the data I/O channels draw additional current proportional to the data rate. Additional supply current associated with an individual channel operating at a given data rate can be calculated as described in the Power Consumption section. The dynamic I/O channel load must be treated as an external load and included in the  $V_{ISO}$  power budget.

<sup>3</sup> The power demands of the quiescent operation of the data channels is not separated from the power supply section. Efficiency includes the quiescent power consumed by the I/O channels as part of the internal power consumption.

<sup>4</sup> This current is available for driving external loads at the  $V_{ISO}$  output. All channels are simultaneously driven at a maximum data rate of 25 Mbps with full capacitive load representing the maximum dynamic load conditions. Refer to the Power Consumption section for calculation of the available current at less than the maximum data rate.



**ELECTRICAL CHARACTERISTICS—5 V PRIMARY INPUT SUPPLY/15 V SECONDARY ISOLATED SUPPLY**

4.5 V ≤ V<sub>DD1</sub> = V<sub>DDA</sub> ≤ 5.5 V; V<sub>REG</sub> = V<sub>ISO</sub> = 15 V; V<sub>DD2</sub> = 5.0 V; f<sub>SW</sub> = 500 kHz; all voltages are relative to their respective grounds (see the application schematic in Figure 39). All minimum/maximum specifications apply over the entire recommended operating range, unless otherwise noted. All typical specifications are at T<sub>A</sub> = 25°C, V<sub>DD1</sub> = V<sub>DDA</sub> = 5.0 V, V<sub>REG</sub> = V<sub>ISO</sub> = 15 V, V<sub>DD2</sub> = 5.0 V.

**Table 4.**

Parameter	Symbol	Min	Typ	Max	Unit	Test Conditions/Comments
<b>DC-TO-DC CONVERTER POWER SUPPLY</b>						
Isolated Output Voltage	V <sub>ISO</sub>	13.5	15	16.5	V	I <sub>ISO</sub> = 0 mA, V <sub>ISO</sub> = V <sub>FB</sub> × (R1 + R2)/R2
Feedback Voltage Setpoint	V <sub>FB</sub>	1.125	1.25	1.375	V	I <sub>ISO</sub> = 0 mA
V <sub>DD2</sub> Linear Regulator Regulator Voltage	V <sub>DD2</sub>	4.6	5.0	5.7	V	V <sub>REG</sub> = 7 V to 15 V, I <sub>DD2</sub> = 0 mA to 50 mA
Dropout Voltage	V <sub>DD2</sub> (DO)		0.5	1.5	V	I <sub>DD2</sub> = 50 mA
Line Regulation	V <sub>ISO</sub> (LINE)		1	20	mV/V	I <sub>ISO</sub> = 50 mA, V <sub>DD1</sub> = 4.5 V to 5.5 V
Load Regulation	V <sub>ISO</sub> (LOAD)		1	3	%	I <sub>ISO</sub> = 20 mA to 100 mA
Output Ripple	V <sub>ISO</sub> (RIP)		200		mV p-p	20 MHz bandwidth, C <sub>OUT</sub> = 0.1 μF  47 μF, I <sub>ISO</sub> = 100 mA
Output Noise	V <sub>ISO</sub> (N)		500		mV p-p	20 MHz bandwidth, C <sub>OUT</sub> = 0.1 μF  47 μF, I <sub>ISO</sub> = 100 mA
Switching Frequency	f <sub>SW</sub>		1000		kHz	R <sub>OC</sub> = 50 kΩ
			200		kHz	R <sub>OC</sub> = 270 kΩ
		192	318	515	kHz	V <sub>OC</sub> = V <sub>DD2</sub> (open loop)
Switch On Resistance	R <sub>ON</sub>		0.5		Ω	
Undervoltage Lockout, V <sub>DD1</sub> , V <sub>DD2</sub> Supplies						
Positive Going Threshold	V <sub>UV+</sub>		2.8		V	
Negative Going Threshold	V <sub>UV-</sub>		2.6		V	
Hysteresis	V <sub>UVH</sub>		0.2		V	
DC to 2 Mbps Data Rate <sup>1</sup>						f ≤ 1 MHz
Maximum Output Supply Current <sup>2</sup>	I <sub>ISO</sub> (MAX)	100			mA	V <sub>ISO</sub> = 5.0 V
Efficiency at Maximum Output Supply Current <sup>3</sup>			70		%	I <sub>ISO</sub> = I <sub>ISO</sub> (MAX)
<b>iCOUPLER DATA CHANNELS</b>						
DC to 2 Mbps Data Rate <sup>1</sup>						
I <sub>DD1</sub> Supply Current, No V <sub>ISO</sub> Load	I <sub>DD1</sub> (Q)					I <sub>ISO</sub> = 0 mA, f ≤ 1 MHz
ADuM3470			25	45	mA	
ADuM3471			27	45	mA	
ADuM3472			29	45	mA	
ADuM3473			31	45	mA	
ADuM3474			33	45	mA	
25 Mbps Data Rate (C Grade Only)						
I <sub>DD1</sub> Supply Current, No V <sub>ISO</sub> Load	I <sub>DD1</sub> (D)					I <sub>ISO</sub> = 0 mA, C <sub>L</sub> = 15 pF, f = 12.5 MHz
ADuM3470			73		mA	
ADuM3471			83		mA	
ADuM3472			93		mA	
ADuM3473			102		mA	
ADuM3474			112		mA	
Available V <sub>ISO</sub> Supply Current <sup>4</sup>	I <sub>ISO</sub> (LOAD)					C <sub>L</sub> = 15 pF, f = 12.5 MHz
ADuM3470			91		mA	
ADuM3471			89		mA	
ADuM3472			86		mA	
ADuM3473			83		mA	
ADuM3474			80		mA	
I <sub>DD1</sub> Supply Current, Full V <sub>ISO</sub> Load	I <sub>DD1</sub> (MAX)		425		mA	C <sub>L</sub> = 0 pF, f = 0 MHz, V <sub>DD1</sub> = 5 V, I <sub>ISO</sub> = 100 mA

Parameter	Symbol	Min	Typ	Max	Unit	Test Conditions/Comments
I/O Input Currents	$I_{IA}, I_{IB}, I_{IC}, I_{ID}$	-20	+0.01	+20	$\mu\text{A}$	
Logic High Input Threshold	$V_{IH}$	2.0			V	
Logic Low Input Threshold	$V_{IL}$			0.8	V	
Logic High Output Voltages	$V_{OAH}, V_{OBH}, V_{OCH}, V_{ODH}$	$V_{DD1} - 0.3,$ $V_{ISO} - 0.3$	5.0		V	$I_{Ox} = -20 \mu\text{A}, V_{Ix} = V_{IxH}$
		$V_{DD1} - 0.5,$ $V_{ISO} - 0.5$	4.8		V	$I_{Ox} = -4 \text{ mA}, V_{Ix} = V_{IxH}$
Logic Low Output Voltages	$V_{OAL}, V_{OBL}, V_{OCL}, V_{ODL}$		0.0	0.1	V	$I_{Ox} = 20 \mu\text{A}, V_{Ix} = V_{IxL}$
			0.0	0.4	V	$I_{Ox} = 4 \text{ mA}, V_{Ix} = V_{IxL}$
<b>AC SPECIFICATIONS</b>						
<b>A Grade</b>						
Minimum Pulse Width	PW			1000	ns	$C_L = 15 \text{ pF}$ , CMOS signal levels
Maximum Data Rate		1			Mbps	
Propagation Delay	$t_{PHL}, t_{PLH}$		55	100	ns	
Pulse Width Distortion, $ t_{PLH} - t_{PHL} $	PWD			40	ns	
Propagation Delay Skew	$t_{PSK}$			50	ns	
Channel-to-Channel Matching	$t_{PSKCD}/t_{PSKOD}$			50	ns	
<b>C Grade</b>						
Minimum Pulse Width	PW			40	ns	$C_L = 15 \text{ pF}$ , CMOS signal levels
Maximum Data Rate		25			Mbps	
Propagation Delay	$t_{PHL}, t_{PLH}$	30	45	60	ns	
Pulse Width Distortion, $ t_{PLH} - t_{PHL} $	PWD			8	ns	
Change vs. Temperature			5		ps/°C	
Propagation Delay Skew	$t_{PSK}$			15	ns	
Channel-to-Channel Matching						
Codirectional Channels	$t_{PSKCD}$			8	ns	
Opposing Directional Channels	$t_{PSKOD}$			15	ns	
Output Rise/Fall Time (10% to 90%)	$t_R/t_F$		2.5		ns	$C_L = 15 \text{ pF}$ , CMOS signal levels
Common-Mode Transient Immunity						$V_{CM} = 1000 \text{ V}$ , transient magnitude = 800 V
At Logic High Output	$ CM_H $	25	35		kV/ $\mu\text{s}$	$V_{Ix} = V_{DD1}$ or $V_{ISO}$
At Logic Low Output	$ CM_L $	25	35		kV/ $\mu\text{s}$	$V_{Ix} = 0 \text{ V}$
Refresh Rate	$f_r$		1.0		Mbps	

<sup>1</sup> The contributions of supply current values for all four channels are combined at identical data rates.

<sup>2</sup> The  $V_{ISO}$  supply current is available for external use when all data rates are below 2 Mbps. At data rates above 2 Mbps, the data I/O channels draw additional current proportional to the data rate. Additional supply current associated with an individual channel operating at a given data rate can be calculated as described in the Power Consumption section. The dynamic I/O channel load must be treated as an external load and included in the  $V_{ISO}$  power budget.

<sup>3</sup> The power demands of the quiescent operation of the data channels is not separated from the power supply section. Efficiency includes the quiescent power consumed by the I/O channels as part of the internal power consumption.

<sup>4</sup> This current is available for driving external loads at the  $V_{ISO}$  output. All channels are simultaneously driven at a maximum data rate of 25 Mbps with full capacitive load representing the maximum dynamic load conditions. Refer to the Power Consumption section for calculation of the available current at less than the maximum data rate.

**PACKAGE CHARACTERISTICS**

Table 5.

Parameter	Symbol	Min	Typ	Max	Unit	Test Conditions/Comments
RESISTANCE AND CAPACITANCE						
Resistance (Input to Output) <sup>1</sup>	R <sub>I-O</sub>		10 <sup>12</sup>		Ω	f = 1 MHz  Thermocouple is located at the center of the package underside; test conducted on a 4-layer board with thin traces <sup>3</sup>
Capacitance (Input to Output) <sup>1</sup>	C <sub>I-O</sub>		2.2		pF	
Input Capacitance <sup>2</sup>	C <sub>I</sub>		4.0		pF	
IC Junction to Ambient Thermal Resistance	θ <sub>JA</sub>		50.5		°C/W	
THERMAL SHUTDOWN						
Thermal Shutdown Threshold	T <sub>SD</sub>		150		°C	T <sub>J</sub> rising
Thermal Shutdown Hysteresis	T <sub>SD-HYS</sub>		20		°C	

<sup>1</sup> The device is considered a 2-terminal device: Pin 1 to Pin 10 are shorted together, and Pin 11 to Pin 20 are shorted together.

<sup>2</sup> Input capacitance is from any input data pin to ground.

<sup>3</sup> See the Thermal Analysis section for thermal model definitions.

**REGULATORY APPROVALS**

The [ADuM3470/ADuM3471/ADuM3472/ADuM3473/ADuM3474](#) are approved by the organizations listed in Table 6. Refer to Table 11 and the Insulation Lifetime section for more information about the recommended maximum working voltages for specific cross-insulation waveforms and insulation levels.

Table 6.

UL	CSA	VDE
Recognized under the UL 1577 component recognition program <sup>1</sup>	Approved under CSA Component Acceptance Notice #5A	Certified according to DIN V VDE V 0884-10 (VDE V 0884-10):2006-12 <sup>2</sup>
Single protection, 2500 V rms isolation voltage	Basic insulation per CSA 60950-1-03 and IEC 60950-1, 600 V rms (848 V peak) maximum working voltage	Reinforced insulation, 560 V peak
File E214100	File 205078	File 2471900-4880-0001

<sup>1</sup> In accordance with UL 1577, each [ADuM3470/ADuM3471/ADuM3472/ADuM3473/ADuM3474](#) is proof tested by applying an insulation test voltage of ≥3000 V rms for 1 sec (current leakage detection limit = 10 μA).

<sup>2</sup> In accordance with DIN V VDE V 0884-10 (VDE V 0884-10):2006-12, each [ADuM3470/ADuM3471/ADuM3472/ADuM3473/ADuM3474](#) is proof tested by applying an insulation test voltage of ≥1050 V peak for 1 sec (partial discharge detection limit = 5 pC). The asterisk (\*) marking branded on the component designates DIN V VDE V 0884-10 (VDE V 0884-10):2006-12 approval.

**INSULATION AND SAFETY-RELATED SPECIFICATIONS**

Table 7.

Parameter	Symbol	Value	Unit	Test Conditions/Comments
Rated Dielectric Insulation Voltage		2500	V rms	1-minute duration
Minimum External Air Gap (Clearance)	L(I01)	>5.1	mm	Measured from input terminals to output terminals, shortest distance through air
Minimum External Tracking (Creepage)	L(I02)	>5.1	mm	Measured from input terminals to output terminals, shortest distance path along body
Minimum Internal Distance (Internal Clearance)		0.017 min	mm	Distance through insulation
Tracking Resistance (Comparative Tracking Index)	CTI	>400	V	DIN IEC 112/VDE 0303, Part 1
Isolation Group		II		Material Group (DIN VDE 0110, 1/89, Table 1)

**DIN V VDE V 0884-10 (VDE V 0884-10):2006-12 INSULATION CHARACTERISTICS**

These isolators are suitable for reinforced electrical isolation only within the safety limit data. Maintenance of the safety data is ensured by protective circuits. The asterisk (\*) marking branded on the component denotes DIN V VDE V 0884-10 (VDE V 0884-10):2006-12 approval.

**Table 8.**

Description	Test Conditions/Comments	Symbol	Characteristic	Unit
Installation Classification per DIN VDE 0110 For Rated Mains Voltage ≤ 150 V rms For Rated Mains Voltage ≤ 300 V rms For Rated Mains Voltage ≤ 400 V rms			I to IV I to III I to II	
Climatic Classification			40/105/21	
Pollution Degree per DIN VDE 0110, Table 1			2	
Maximum Working Insulation Voltage		V <sub>IORM</sub>	560	V peak
Input-to-Output Test Voltage, Method B1	V <sub>IORM</sub> × 1.875 = V <sub>PR</sub> , 100% production test, t <sub>m</sub> = 1 sec, partial discharge < 5 pC	V <sub>PR</sub>	1050	V peak
Input-to-Output Test Voltage, Method A		V <sub>PR</sub>		
After Environmental Tests Subgroup 1	V <sub>IORM</sub> × 1.6 = V <sub>PR</sub> , t <sub>m</sub> = 60 sec, partial discharge < 5 pC		896	V peak
After Input and/or Safety Tests Subgroup 2 and Subgroup 3	V <sub>IORM</sub> × 1.2 = V <sub>PR</sub> , t <sub>m</sub> = 60 sec, partial discharge < 5 pC		672	V peak
Highest Allowable Overvoltage	Transient overvoltage, t <sub>TR</sub> = 10 sec	V <sub>TR</sub>	4000	V peak
Safety Limiting Values	Maximum value allowed in the event of a failure (see Figure 3)			
Case Temperature		T <sub>S</sub>	150	°C
Side 1 Current		I <sub>S1</sub>	1.25	A
Insulation Resistance at T <sub>S</sub>	V <sub>IO</sub> = 500 V	R <sub>S</sub>	>10 <sup>9</sup>	Ω



Figure 3. Thermal Derating Curve, Dependence of Safety Limiting Values on Case Temperature, per DIN EN 60747-5-2

**RECOMMENDED OPERATING CONDITIONS**

**Table 9.**

Parameter	Symbol	Min	Max	Unit
Operating Temperature	T <sub>A</sub>	-40	+105	°C
Supply Voltages <sup>1</sup>				
V <sub>DD1</sub> at V <sub>ISO</sub> = 3.3 V	V <sub>DD1</sub>	3.0	3.6	V
V <sub>DD1</sub> at V <sub>ISO</sub> = 5.0 V	V <sub>DD1</sub>	3.0	3.6	V
V <sub>DD1</sub> at V <sub>ISO</sub> = 5.0 V	V <sub>DD1</sub>	4.5	5.5	V
Minimum Load	I <sub>ISO (MIN)</sub>	10		mA

<sup>1</sup> All voltages are relative to their respective grounds.

## ABSOLUTE MAXIMUM RATINGS

Ambient temperature = 25°C, unless otherwise noted.

Table 10.

Parameter	Rating
Storage Temperature Range (T <sub>ST</sub> )	–55°C to +150°C
Ambient Operating Temperature Range (T <sub>A</sub> )	–40°C to +105°C
Supply Voltages <sup>1</sup>	
V <sub>DD1</sub> , <sup>2</sup> V <sub>DDA</sub> , V <sub>DD2</sub>	–0.5 V to +7.0 V
V <sub>REG</sub> , X1, X2	–0.5 V to +20.0 V
Input Voltage (V <sub>IA</sub> , V <sub>IB</sub> , V <sub>IC</sub> , V <sub>ID</sub> ) <sup>1,3</sup>	–0.5 V to V <sub>DD1</sub> + 0.5 V
Output Voltage (V <sub>OA</sub> , V <sub>OB</sub> , V <sub>OC</sub> , V <sub>OD</sub> ) <sup>1,3</sup>	–0.5 V to V <sub>DDO</sub> + 0.5 V
Average Output Current per Pin <sup>4</sup>	–10 mA to +10 mA
Common-Mode Transients <sup>5</sup>	–100 kV/μs to +100 kV/μs

<sup>1</sup> All voltages are relative to their respective grounds.

<sup>2</sup> V<sub>DD1</sub> is the power supply for the push-pull transformer.

<sup>3</sup> V<sub>DDi</sub> and V<sub>DDO</sub> refer to the supply voltages on the input and output sides of a given channel, respectively. See the Printed Circuit Board (PCB) Layout section.

<sup>4</sup> See Figure 3 for maximum rated current values for various temperatures.

<sup>5</sup> Refers to common-mode transients across the insulation barrier. Common-mode transients exceeding the absolute maximum ratings may cause latch-up or permanent damage.

Stresses above those listed under Absolute Maximum Ratings may cause permanent damage to the device. This is a stress rating only; functional operation of the device at these or any other conditions above those indicated in the operational section of this specification is not implied. Exposure to absolute maximum rating conditions for extended periods may affect device reliability.

Table 11. Maximum Continuous Working Voltage Supporting 50-Year Minimum Lifetime<sup>1</sup>

Parameter	Max	Unit	Applicable Certification
AC Voltage, Bipolar Waveform	565	V peak	All certifications
AC Voltage, Unipolar Waveform			
Basic Insulation	848	V peak	Working voltage per IEC 60950-1
DC Voltage			
Basic Insulation	848	V peak	Working voltage per IEC 60950-1

<sup>1</sup> Refers to the continuous voltage magnitude imposed across the isolation barrier. See the Insulation Lifetime section for more information.

### ESD CAUTION



**ESD (electrostatic discharge) sensitive device.** Charged devices and circuit boards can discharge without detection. Although this product features patented or proprietary protection circuitry, damage may occur on devices subjected to high energy ESD. Therefore, proper ESD precautions should be taken to avoid performance degradation or loss of functionality.

## PIN CONFIGURATIONS AND FUNCTION DESCRIPTIONS



## NOTES

1. NC = NO INTERNAL CONNECTION.
2. PIN 2 AND PIN 10 ARE INTERNALLY CONNECTED TO EACH OTHER; IT IS RECOMMENDED THAT BOTH PINS BE CONNECTED TO A COMMON GROUND.
3. PIN 11 AND PIN 19 ARE INTERNALLY CONNECTED TO EACH OTHER; IT IS RECOMMENDED THAT BOTH PINS BE CONNECTED TO A COMMON GROUND.

09368-004

Figure 4. ADuM3470 Pin Configuration

Table 12. ADuM3470 Pin Function Descriptions

Pin No.	Mnemonic	Description
1	X1	Transformer Driver Output 1.
2, 10	GND <sub>1</sub>	Ground Reference for the Primary Side of the Isolator. Pin 2 and Pin 10 are internally connected to each other; it is recommended that both pins be connected to a common ground.
3	NC	No Internal Connection.
4	X2	Transformer Driver Output 2.
5	V <sub>1A</sub>	Logic Input A.
6	V <sub>1B</sub>	Logic Input B.
7	V <sub>1C</sub>	Logic Input C.
8	V <sub>1D</sub>	Logic Input D.
9	V <sub>DDA</sub>	Supply Voltage for the Primary Side, 3.0 V to 5.5 V. Connect a 0.1 μF bypass capacitor from V <sub>DDA</sub> to GND <sub>1</sub> .
11, 19	GND <sub>2</sub>	Ground Reference for the Secondary Side of the Isolator. Pin 11 and Pin 19 are internally connected to each other; it is recommended that both pins be connected to a common ground.
12	OC	Oscillator Control Pin. When the OC pin is connected high to the V <sub>DD2</sub> pin, the secondary controller runs in open-loop (unregulated) mode. To regulate the output voltage, connect a resistor between the OC pin and GND <sub>2</sub> ; the secondary controller runs at a frequency of 200 kHz to 1 MHz, as programmed by the resistor value.
13	V <sub>OD</sub>	Logic Output D.
14	V <sub>OC</sub>	Logic Output C.
15	V <sub>OB</sub>	Logic Output B.
16	V <sub>OA</sub>	Logic Output A.
17	FB	Feedback Input from the Secondary Output Voltage, V <sub>ISO</sub> . Use a resistor divider from the V <sub>ISO</sub> output to the FB pin to set the V <sub>FB</sub> voltage equal to the 1.25 V internal reference level using the formula $V_{ISO} = V_{FB} \times (R1 + R2)/R2$ . The resistor divider is required even in open-loop mode to provide soft start.
18	V <sub>DD2</sub>	Internal Supply Voltage for the Secondary Side Controller and the Side 2 Data Channels. When a sufficient external voltage is supplied to V <sub>REG</sub> , the internal regulator regulates the V <sub>DD2</sub> pin to 5.0 V. Otherwise, V <sub>DD2</sub> should be in the 3.0 V to 5.5 V range. Connect a 0.1 μF bypass capacitor from V <sub>DD2</sub> to GND <sub>2</sub> .
20	V <sub>REG</sub>	Input of the Internal Regulator to Power the Secondary Side Controller and the Side 2 Data Channels. V <sub>REG</sub> should be in the 5.5 V to 15 V range to regulate the V <sub>DD2</sub> output to 5.0 V.

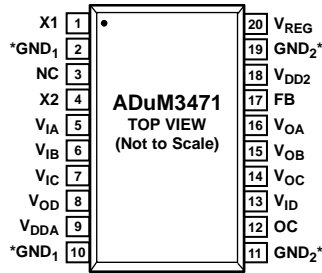

## NOTES

1. NC = NO INTERNAL CONNECTION.
2. PIN 2 AND PIN 10 ARE INTERNALLY CONNECTED TO EACH OTHER; IT IS RECOMMENDED THAT BOTH PINS BE CONNECTED TO A COMMON GROUND.
3. PIN 11 AND PIN 19 ARE INTERNALLY CONNECTED TO EACH OTHER; IT IS RECOMMENDED THAT BOTH PINS BE CONNECTED TO A COMMON GROUND.

09389-005

Figure 5. ADuM3471 Pin Configuration

Table 13. ADuM3471 Pin Function Descriptions

Pin No.	Mnemonic	Description
1	X1	Transformer Driver Output 1.
2, 10	GND <sub>1</sub>	Ground Reference for the Primary Side of the Isolator. Pin 2 and Pin 10 are internally connected to each other; it is recommended that both pins be connected to a common ground.
3	NC	No Internal Connection.
4	X2	Transformer Driver Output 2.
5	V <sub>1A</sub>	Logic Input A.
6	V <sub>1B</sub>	Logic Input B.
7	V <sub>1C</sub>	Logic Input C.
8	V <sub>1D</sub>	Logic Output D.
9	V <sub>DDA</sub>	Supply Voltage for the Primary Side, 3.0 V to 5.5 V. Connect a 0.1 $\mu$ F bypass capacitor from V <sub>DDA</sub> to GND <sub>1</sub> .
11, 19	GND <sub>2</sub>	Ground Reference for the Secondary Side of the Isolator. Pin 11 and Pin 19 are internally connected to each other; it is recommended that both pins be connected to a common ground.
12	OC	Oscillator Control Pin. When the OC pin is connected high to the V <sub>DD2</sub> pin, the secondary controller runs in open-loop (unregulated) mode. To regulate the output voltage, connect a resistor between the OC pin and GND <sub>2</sub> ; the secondary controller runs at a frequency of 200 kHz to 1 MHz, as programmed by the resistor value.
13	V <sub>1D</sub>	Logic Input D.
14	V <sub>1C</sub>	Logic Output C.
15	V <sub>1B</sub>	Logic Output B.
16	V <sub>1A</sub>	Logic Output A.
17	FB	Feedback Input from the Secondary Output Voltage, V <sub>ISO</sub> . Use a resistor divider from the V <sub>ISO</sub> output to the FB pin to set the V <sub>FB</sub> voltage equal to the 1.25 V internal reference level using the formula $V_{ISO} = V_{FB} \times (R1 + R2)/R2$ . The resistor divider is required even in open-loop mode to provide soft start.
18	V <sub>DD2</sub>	Internal Supply Voltage for the Secondary Side Controller and the Side 2 Data Channels. When a sufficient external voltage is supplied to V <sub>REG</sub> , the internal regulator regulates the V <sub>DD2</sub> pin to 5.0 V. Otherwise, V <sub>DD2</sub> should be in the 3.0 V to 5.5 V range. Connect a 0.1 $\mu$ F bypass capacitor from V <sub>DD2</sub> to GND <sub>2</sub> .
20	V <sub>REG</sub>	Input of the Internal Regulator to Power the Secondary Side Controller and the Side 2 Data Channels. V <sub>REG</sub> should be in the 5.5 V to 15 V range to regulate the V <sub>DD2</sub> output to 5.0 V.



## NOTES

1. NC = NO INTERNAL CONNECTION.
2. PIN 2 AND PIN 10 ARE INTERNALLY CONNECTED TO EACH OTHER; IT IS RECOMMENDED THAT BOTH PINS BE CONNECTED TO A COMMON GROUND.
3. PIN 11 AND PIN 19 ARE INTERNALLY CONNECTED TO EACH OTHER; IT IS RECOMMENDED THAT BOTH PINS BE CONNECTED TO A COMMON GROUND.

09389-006

Figure 6. ADuM3472 Pin Configuration

Table 14. ADuM3472 Pin Function Descriptions

Pin No.	Mnemonic	Description
1	X1	Transformer Driver Output 1.
2, 10	GND <sub>1</sub>	Ground Reference for the Primary Side of the Isolator. Pin 2 and Pin 10 are internally connected to each other; it is recommended that both pins be connected to a common ground.
3	NC	No Internal Connection.
4	X2	Transformer Driver Output 2.
5	V <sub>1A</sub>	Logic Input A.
6	V <sub>1B</sub>	Logic Input B.
7	V <sub>1OC</sub>	Logic Output C.
8	V <sub>1OD</sub>	Logic Output D.
9	V <sub>1DDA</sub>	Supply Voltage for the Primary Side, 3.0 V to 5.5 V. Connect a 0.1 μF bypass capacitor from V <sub>1DDA</sub> to GND <sub>1</sub> .
11, 19	GND <sub>2</sub>	Ground Reference for the Secondary Side of the Isolator. Pin 11 and Pin 19 are internally connected to each other; it is recommended that both pins be connected to a common ground.
12	OC	Oscillator Control Pin. When the OC pin is connected high to the V <sub>1DD2</sub> pin, the secondary controller runs in open-loop (unregulated) mode. To regulate the output voltage, connect a resistor between the OC pin and GND <sub>2</sub> ; the secondary controller runs at a frequency of 200 kHz to 1 MHz, as programmed by the resistor value.
13	V <sub>1ID</sub>	Logic Input D.
14	V <sub>1IC</sub>	Logic Input C.
15	V <sub>1OB</sub>	Logic Output B.
16	V <sub>1OA</sub>	Logic Output A.
17	FB	Feedback Input from the Secondary Output Voltage, V <sub>1SO</sub> . Use a resistor divider from the V <sub>1SO</sub> output to the FB pin to set the V <sub>1FB</sub> voltage equal to the 1.25 V internal reference level using the formula $V_{1SO} = V_{1FB} \times (R1 + R2)/R2$ . The resistor divider is required even in open-loop mode to provide soft start.
18	V <sub>1DD2</sub>	Internal Supply Voltage for the Secondary Side Controller and the Side 2 Data Channels. When a sufficient external voltage is supplied to V <sub>1REG</sub> , the internal regulator regulates the V <sub>1DD2</sub> pin to 5.0 V. Otherwise, V <sub>1DD2</sub> should be in the 3.0 V to 5.5 V range. Connect a 0.1 μF bypass capacitor from V <sub>1DD2</sub> to GND <sub>2</sub> .
20	V <sub>1REG</sub>	Input of the Internal Regulator to Power the Secondary Side Controller and the Side 2 Data Channels. V <sub>1REG</sub> should be in the 5.5 V to 15 V range to regulate the V <sub>1DD2</sub> output to 5.0 V.



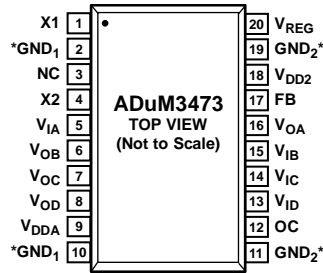

## NOTES

1. NC = NO INTERNAL CONNECTION.
2. PIN 2 AND PIN 10 ARE INTERNALLY CONNECTED TO EACH OTHER; IT IS RECOMMENDED THAT BOTH PINS BE CONNECTED TO A COMMON GROUND.
3. PIN 11 AND PIN 19 ARE INTERNALLY CONNECTED TO EACH OTHER; IT IS RECOMMENDED THAT BOTH PINS BE CONNECTED TO A COMMON GROUND.

09386-007

Figure 7. ADuM3473 Pin Configuration

Table 15. ADuM3473 Pin Function Descriptions

Pin No.	Mnemonic	Description
1	X1	Transformer Driver Output 1.
2, 10	GND <sub>1</sub>	Ground Reference for the Primary Side of the Isolator. Pin 2 and Pin 10 are internally connected to each other; it is recommended that both pins be connected to a common ground.
3	NC	No Internal Connection.
4	X2	Transformer Driver Output 2.
5	V <sub>1A</sub>	Logic Input A.
6	V <sub>0B</sub>	Logic Output B.
7	V <sub>0C</sub>	Logic Output C.
8	V <sub>0D</sub>	Logic Output D.
9	V <sub>DDA</sub>	Supply Voltage for the Primary Side, 3.0 V to 5.5 V. Connect a 0.1 μF bypass capacitor from V <sub>DDA</sub> to GND <sub>1</sub> .
11, 19	GND <sub>2</sub>	Ground Reference for the Secondary Side of the Isolator. Pin 11 and Pin 19 are internally connected to each other; it is recommended that both pins be connected to a common ground.
12	OC	Oscillator Control Pin. When the OC pin is connected high to the V <sub>DD2</sub> pin, the secondary controller runs in open-loop (unregulated) mode. To regulate the output voltage, connect a resistor between the OC pin and GND <sub>2</sub> ; the secondary controller runs at a frequency of 200 kHz to 1 MHz, as programmed by the resistor value.
13	V <sub>ID</sub>	Logic Input D.
14	V <sub>IC</sub>	Logic Input C.
15	V <sub>IB</sub>	Logic Input B.
16	V <sub>OA</sub>	Logic Output A.
17	FB	Feedback Input from the Secondary Output Voltage, V <sub>ISO</sub> . Use a resistor divider from the V <sub>ISO</sub> output to the FB pin to set the V <sub>FB</sub> voltage equal to the 1.25 V internal reference level using the formula $V_{ISO} = V_{FB} \times (R1 + R2)/R2$ . The resistor divider is required even in open-loop mode to provide soft start.
18	V <sub>DD2</sub>	Internal Supply Voltage for the Secondary Side Controller and the Side 2 Data Channels. When a sufficient external voltage is supplied to V <sub>REG</sub> , the internal regulator regulates the V <sub>DD2</sub> pin to 5.0 V. Otherwise, V <sub>DD2</sub> should be in the 3.0 V to 5.5 V range. Connect a 0.1 μF bypass capacitor from V <sub>DD2</sub> to GND <sub>2</sub> .
20	V <sub>REG</sub>	Input of the Internal Regulator to Power the Secondary Side Controller and the Side 2 Data Channels. V <sub>REG</sub> should be in the 5.5 V to 15 V range to regulate the V <sub>DD2</sub> output to 5.0 V.



## NOTES

1. NC = NO INTERNAL CONNECTION.
2. PIN 2 AND PIN 10 ARE INTERNALLY CONNECTED TO EACH OTHER; IT IS RECOMMENDED THAT BOTH PINS BE CONNECTED TO A COMMON GROUND.
3. PIN 11 AND PIN 19 ARE INTERNALLY CONNECTED TO EACH OTHER; IT IS RECOMMENDED THAT BOTH PINS BE CONNECTED TO A COMMON GROUND.

09389-008

Figure 8. ADuM3474 Pin Configuration

Table 16. ADuM3474 Pin Function Descriptions

Pin No.	Mnemonic	Description
1	X1	Transformer Driver Output 1.
2, 10	GND <sub>1</sub>	Ground Reference for the Primary Side of the Isolator. Pin 2 and Pin 10 are internally connected to each other; it is recommended that both pins be connected to a common ground.
3	NC	No Internal Connection.
4	X2	Transformer Driver Output 2.
5	V <sub>OA</sub>	Logic Output A.
6	V <sub>OB</sub>	Logic Output B.
7	V <sub>OC</sub>	Logic Output C.
8	V <sub>OD</sub>	Logic Output D.
9	V <sub>DDA</sub>	Supply Voltage for the Primary Side, 3.0 V to 5.5 V. Connect a 0.1 μF bypass capacitor from V <sub>DDA</sub> to GND <sub>1</sub> .
11, 19	GND <sub>2</sub>	Ground Reference for the Secondary Side of the Isolator. Pin 11 and Pin 19 are internally connected to each other; it is recommended that both pins be connected to a common ground.
12	OC	Oscillator Control Pin. When the OC pin is connected high to the V <sub>DD2</sub> pin, the secondary controller runs in open-loop (unregulated) mode. To regulate the output voltage, connect a resistor between the OC pin and GND <sub>2</sub> ; the secondary controller runs at a frequency of 200 kHz to 1 MHz, as programmed by the resistor value.
13	V <sub>ID</sub>	Logic Input D.
14	V <sub>IC</sub>	Logic Input C.
15	V <sub>IB</sub>	Logic Input B.
16	V <sub>IA</sub>	Logic Input A.
17	FB	Feedback Input from the Secondary Output Voltage, V <sub>ISO</sub> . Use a resistor divider from the V <sub>ISO</sub> output to the FB pin to set the V <sub>FB</sub> voltage equal to the 1.25 V internal reference level using the formula $V_{ISO} = V_{FB} \times (R1 + R2)/R2$ . The resistor divider is required even in open-loop mode to provide soft start.
18	V <sub>DD2</sub>	Internal Supply Voltage for the Secondary Side Controller and the Side 2 Data Channels. When a sufficient external voltage is supplied to V <sub>REG</sub> , the internal regulator regulates the V <sub>DD2</sub> pin to 5.0 V. Otherwise, V <sub>DD2</sub> should be in the 3.0 V to 5.5 V range. Connect a 0.1 μF bypass capacitor from V <sub>DD2</sub> to GND <sub>2</sub> .
20	V <sub>REG</sub>	Input of the Internal Regulator to Power the Secondary Side Controller and the Side 2 Data Channels. V <sub>REG</sub> should be in the 5.5 V to 15 V range to regulate the V <sub>DD2</sub> output to 5.0 V.

Table 17. Truth Table (Positive Logic)

V <sub>ix</sub> Input <sup>1</sup>	V <sub>DD1</sub> State	V <sub>DD2</sub> State	V <sub>ox</sub> Output <sup>1</sup>	Notes
High	Powered	Powered	High	Normal operation, data is high
Low	Powered	Powered	Low	Normal operation, data is low

<sup>1</sup> V<sub>ix</sub> and V<sub>ox</sub> refer to the input and output signals of a given channel (A, B, C, or D).

TYPICAL PERFORMANCE CHARACTERISTICS



Figure 9. Switching Frequency (f<sub>sw</sub>) vs. R<sub>oc</sub> Resistance

08389-009



Figure 12. Typical Efficiency over Temperature with Coilcraft Transformer, f<sub>sw</sub> = 500 kHz, 5 V Input to 5 V Output

08389-012



Figure 10. Typical Efficiency at Various Switching Frequencies with Coilcraft Transformer, 5 V Input to 5 V Output

08389-010



Figure 13. Single-Supply Efficiency with Coilcraft Transformer, f<sub>sw</sub> = 500 kHz

08389-013



Figure 11. Typical Efficiency at Various Switching Frequencies with Halo Transformer, 5 V Input to 5 V Output

08389-011



Figure 14. Typical Efficiency at Various Switching Frequencies with Coilcraft Transformer, 5 V Input to 15 V Output

08389-014



Figure 15. Typical Efficiency at Various Switching Frequencies with Halo Transformer, 5 V Input to 15 V Output



Figure 18. Typical Single-Supply  $I_{CH}$  Supply Current per Forward Data Channel (15 pF Output Load)



Figure 16. Typical Efficiency over Temperature with Coilcraft Transformer,  $f_{SW} = 500$  kHz, 5 V Input to 15 V Output



Figure 19. Typical Single-Supply  $I_{CH}$  Supply Current per Reverse Data Channel (15 pF Output Load)



Figure 17. Double-Supply Efficiency with Coilcraft Transformer,  $f_{SW} = 500$  kHz



Figure 20. Typical Single-Supply  $I_{ISO(D)}$  Dynamic Supply Current per Output Channel (15 pF Output Load)



Figure 21. Typical Single-Supply  $I_{ISO(D)}$  Dynamic Supply Current per Input Channel



Figure 24. Typical Double-Supply  $I_{ISO(D)}$  Dynamic Supply Current per Output Channel (15 pF Output Load)



Figure 22. Typical Double-Supply  $I_{CH}$  Supply Current per Forward Data Channel (15 pF Output Load)



Figure 25. Typical Double-Supply  $I_{ISO(D)}$  Dynamic Supply Current per Input Channel



Figure 23. Typical Double-Supply  $I_{CH}$  Supply Current per Reverse Data Channel (15 pF Output Load)



Figure 26. Typical  $V_{ISO}$  Startup with 10 mA, 50 mA, and 400 mA Output Load, 5 V Input to 5 V Output



Figure 27. Typical  $V_{ISO}$  Startup with 10 mA, 50 mA, and 400 mA Output Load, 5 V Input to 3.3 V Output



Figure 30. Typical  $V_{ISO}$  Load Transient Response at 10% to 90% of 400 mA Load,  $f_{sw} = 500$  kHz, 5 V Input to 5 V Output



Figure 28. Typical  $V_{ISO}$  Startup with 10 mA, 50 mA, and 250 mA Output Load, 3.3 V Input to 3.3 V Output



Figure 31. Typical  $V_{ISO}$  Load Transient Response at 10% to 90% of 400 mA Load,  $f_{sw} = 500$  kHz, 5 V Input to 3.3 V Output



Figure 29. Typical  $V_{ISO}$  Startup with 10 mA, 20 mA, and 100 mA Output Load, 5 V Input to 15 V Output



Figure 32. Typical  $V_{ISO}$  Load Transient Response at 10% to 90% of 250 mA Load,  $f_{sw} = 500$  kHz, 3.3 V Input to 3.3 V Output



Figure 33. Typical  $V_{ISO}$  Load Transient Response at 10% to 90% of 100 mA Load,  $f_{SW} = 500$  kHz, 5 V Input to 15 V Output



Figure 36. Typical  $V_{ISO}$  Output Voltage Ripple at 250 mA Load,  $f_{SW} = 500$  kHz, 3.3 V Input to 3.3 V Output

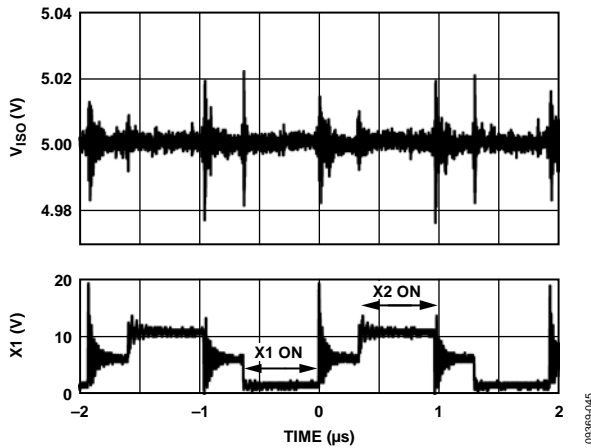

Figure 34. Typical  $V_{ISO}$  Output Voltage Ripple at 400 mA Load,  $f_{SW} = 500$  kHz, 5 V Input to 5 V Output

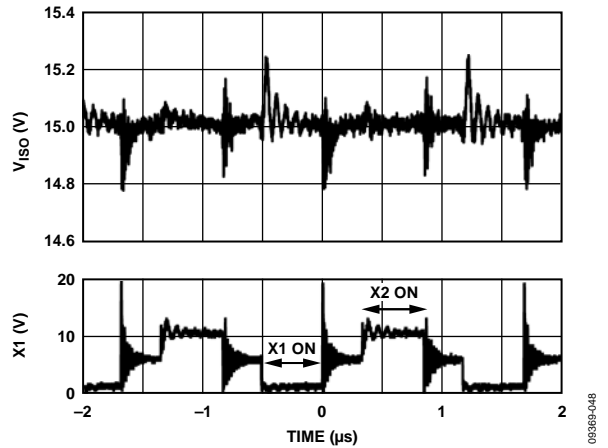

Figure 37. Typical  $V_{ISO}$  Output Voltage Ripple at 100 mA Load,  $f_{SW} = 500$  kHz, 5 V Input to 15 V Output

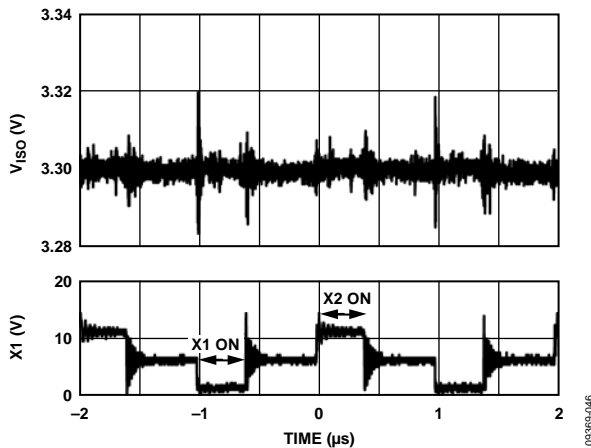

Figure 35. Typical  $V_{ISO}$  Output Voltage Ripple at 400 mA Load,  $f_{SW} = 500$  kHz, 5 V Input to 3.3 V Output

## TERMINOLOGY

### $I_{DD1(Q)}$

$I_{DD1(Q)}$  is the minimum operating current drawn at the  $V_{DD1}$  power input when there is no external load at  $V_{ISO}$  and the I/O pins are operating below 2 Mbps, requiring no additional dynamic supply current.

### $I_{DD1(D)}$

$I_{DD1(D)}$  is the typical input supply current with all channels simultaneously driven at a maximum data rate of 25 Mbps with the full capacitive load representing the maximum dynamic load conditions. Treat resistive loads on the outputs separately from the dynamic load.

### $I_{DD1(MAX)}$

$I_{DD1(MAX)}$  is the input current under full dynamic and  $V_{ISO}$  load conditions.

### $t_{PHL}$ Propagation Delay

The  $t_{PHL}$  propagation delay is measured from the 50% level of the falling edge of the  $V_{Ix}$  signal to the 50% level of the falling edge of the  $V_{Ox}$  signal.

### $t_{PLH}$ Propagation Delay

The  $t_{PLH}$  propagation delay is measured from the 50% level of the rising edge of the  $V_{Ix}$  signal to the 50% level of the rising edge of the  $V_{Ox}$  signal.

### Propagation Delay Skew ( $t_{PSK}$ )

$t_{PSK}$  is the magnitude of the worst-case difference in  $t_{PHL}$  and/or  $t_{PLH}$  that is measured between units at the same operating temperature, supply voltages, and output load within the recommended operating conditions.

### Channel-to-Channel Matching

Channel-to-channel matching is the absolute value of the difference in propagation delays between two channels when operated with identical loads.

### Minimum Pulse Width

The minimum pulse width is the shortest pulse width at which the specified pulse width distortion is guaranteed.

### Maximum Data Rate

The maximum data rate is the fastest data rate at which the specified pulse width distortion is guaranteed.



### APPLICATIONS INFORMATION

The dc-to-dc converter section of the ADuM347x uses a secondary side controller architecture with isolated pulse-width modulation (PWM) feedback. V<sub>DD1</sub> power is supplied to an oscillating circuit that switches current to the primary side of an external power transformer using internal push-pull switches at the X1 and X2 pins. Power transferred to the secondary side of the transformer is full wave rectified with external Schottky diodes (D1 and D2), filtered with the L1 inductor and C<sub>OUT</sub> capacitor, and regulated to the isolated power supply voltage from 3.3 V to 15 V.

The secondary (V<sub>ISO</sub>) side controller regulates the output using a feedback voltage, V<sub>FB</sub>, from a resistor divider on the output to create a PWM control signal that is sent to the primary (V<sub>DD1</sub>) side by a dedicated iCoupler data channel labeled V<sub>FB</sub>. The primary side PWM converter varies the duty cycle of the X1 and X2 switches to modulate the oscillator circuit and control the power being sent to the secondary side. This feedback allows for significantly higher power and efficiency.

The ADuM347x devices implement undervoltage lockout (UVLO) with hysteresis on the V<sub>D<sub>DDA</sub></sub> power input. This feature ensures that the converter does not go into oscillation due to noisy input power or slow power-on ramp rates.

A minimum load current of 10 mA is recommended to ensure optimum load regulation. Smaller loads can generate excess noise on the output due to short or erratic PWM pulses. Excess noise generated in this way can cause regulation problems in some circumstances.

### APPLICATION SCHEMATICS

The ADuM347x devices have three main application schematics, as shown in Figure 38 to Figure 40. Figure 38 has a center-tapped secondary and two Schottky diodes that provide full wave rectification for a single output, typically for power supplies of 3.3 V, 5 V, 12 V, and 15 V. For single supplies when V<sub>ISO</sub> = 3.3 V or 5 V, V<sub>REG</sub>, V<sub>DD2</sub>, and V<sub>ISO</sub> can be connected together.

Figure 39 shows a voltage doubling circuit that can be used for a single supply with an output that exceeds 15 V; 15 V is the largest supply that can be connected to the regulator input, V<sub>REG</sub> (Pin 20). In the circuit shown in Figure 39, the output voltage can be as high as 24 V, and the voltage at the V<sub>REG</sub> pin can be as high as 12 V. When using the circuit shown in Figure 39 to obtain an output voltage lower than 10 V (for example, V<sub>DD1</sub> = 3.3 V, V<sub>ISO</sub> = 5 V), connect V<sub>REG</sub> to V<sub>ISO</sub> directly.

Figure 40, which also uses a voltage doubling secondary circuit, is an example of a coarsely regulated, positive power supply and an unregulated, negative power supply for outputs of approximately ±5 V, ±12 V, and ±15 V.

For all the circuits shown in Figure 38 to Figure 40, the isolated output voltage (V<sub>ISO</sub>) can be set with the voltage dividers, R1 and R2 (values 1 kΩ to 100 kΩ) using the following equation:

$$V_{ISO} = V_{FB} \times (R1 + R2)/R2$$

where V<sub>FB</sub> is the internal feedback voltage (approximately 1.25 V).



Figure 38. Single Power Supply



Figure 39. Doubling Power Supply



Figure 40. Positive Supply and Unregulated Negative Supply

## TRANSFORMER DESIGN

Custom transformers were designed for use in the circuits shown in Figure 38, Figure 39, and Figure 40 (see Table 18). The transformers designed for use with the ADuM347x differ from other transformers used with isolated dc-to-dc converters that do not regulate the output voltage. The output voltage is regulated by a PWM controller in the ADuM347x that varies the duty cycle of the primary side switches in response to a secondary side feedback voltage,  $V_{FB}$ , received through an isolated digital channel. The internal controller has a maximum duty cycle of 40%.

## TRANSFORMER TURNS RATIO

To determine the transformer turns ratio—taking into account the losses for the primary switches and the losses for the secondary diodes and inductors—the external transformer turns ratio for the ADuM347x can be calculated using Equation 1.

$$\frac{N_S}{N_P} = \frac{V_{ISO} + V_D}{V_{DD1(MIN)} \times D \times 2} \quad (1)$$

where:

$N_S/N_P$  is the primary to secondary turns ratio.

$V_{ISO}$  is the isolated output supply voltage.

$V_D$  is the Schottky diode voltage drop (0.5 V maximum).

$V_{DD1(MIN)}$  is the minimum input supply voltage.

$D$  is the duty cycle = 0.30 for a 30% typical duty cycle (40% is the maximum duty cycle).

2 is a multiplier factor used for the push-pull switching cycle.

For the circuit shown in Figure 38 using the 5 V to 5 V reference design in Table 18 and with  $V_{DD1(MIN)} = 4.5$  V, the turns ratio is  $N_S/N_P = 2$ .

For a 3.3 V input to 3.3 V output isolated single power supply and with  $V_{DD1(MIN)} = 3.0$  V, the turns ratio is also  $N_S/N_P = 2$ .

Therefore, the same transformer turns ratio,  $N_S/N_P = 2$ , can be used for the three single power applications: 5 V to 5 V, 5 V to 3.3 V, and 3.3 V to 3.3 V.

The circuit shown in Figure 39 uses double windings and diode pairs to create a doubler circuit; therefore, half the output voltage,  $V_{ISO}/2$ , is used, as shown in Equation 2.

$$\frac{N_S}{N_P} = \frac{\frac{V_{ISO}}{2} + V_D}{V_{DD1(MIN)} \times D \times 2} \quad (2)$$

where:

$N_S/N_P$  is the primary to secondary turns ratio.

$V_{ISO}$  is the isolated output supply voltage.  $V_{ISO}/2$  is used because the circuit uses two pairs of diodes, creating a doubler circuit.

$V_D$  is the Schottky diode voltage drop (0.5 V maximum).

$V_{DD1(MIN)}$  is the minimum input supply voltage.

$D$  is the duty cycle = 0.30 for a 30% typical duty cycle (40% is the maximum duty cycle).

2 is a multiplier factor used for the push-pull switching cycle.

For the circuit shown in Figure 39 using the 5 V to 15 V reference design in Table 18 and with  $V_{DD1(MIN)} = 4.5$  V, the turns ratio is  $N_S/N_P = 3$ .

The circuit shown in Figure 40 also uses double windings and diode pairs to create a doubler circuit. However, because a positive and negative output voltage are created,  $V_{ISO}$  is used, and the external transformer turns ratio can be calculated using Equation 3.

$$\frac{N_S}{N_P} = \frac{V_{ISO} + V_D}{V_{DD1(MIN)} \times D \times 2} \quad (3)$$

where:

$N_S/N_P$  is the primary to secondary turns ratio.

$V_{ISO}$  is the isolated output supply voltage.

$V_D$  is the Schottky diode voltage drop (0.5 V maximum).

$V_{DD1(MIN)}$  is the minimum input supply voltage.

$D$  is the duty cycle = 0.35 for a 35% typical duty cycle (40% is the maximum duty cycle).

2 is a multiplier factor used for the push-pull switching cycle.

For the circuit shown in Figure 40, the duty cycle,  $D$ , is set to 0.35 for a 35% typical duty cycle to reduce the maximum voltages seen by the diodes for a  $\pm 15$  V supply.

For the circuit shown in Figure 40 using the +5 V to  $\pm 15$  V reference design in Table 18 and with  $V_{DD1(MIN)} = 4.5$  V, the turns ratio is  $N_S/N_P = 5$ .

Table 18. Transformer Reference Designs

Part No.	Manufacturer	Turns Ratio, PRI:SEC	ET Constant (V $\times$ $\mu$ s Min)	Total Primary Inductance ( $\mu$ H)	Total Primary Resistance ( $\Omega$ )	Isolation Voltage (rms)	Isolation Type	Reference
JA4631-BL	Coilcraft	1CT:2CT	18	255	0.2	2500	Basic	Figure 38
JA4650-BL	Coilcraft	1CT:3CT	18	255	0.2	2500	Basic	Figure 39
KA4976-AL	Coilcraft	1CT:5CT	18	255	0.2	2500	Basic	Figure 40
TGSAD-260V6LF	Halo Electronics	1CT:2CT	14	389	0.8	2500	Supplemental	Figure 38
TGSAD-290V6LF	Halo Electronics	1CT:3CT	14	389	0.8	2500	Supplemental	Figure 39
TGSAD-292V6LF	Halo Electronics	1CT:5CT	14	389	0.8	2500	Supplemental	Figure 40
TGAD-260NARL	Halo Electronics	1CT:2CT	14	389	0.8	1500	Functional	Figure 38
TGAD-290NARL	Halo Electronics	1CT:3CT	14	389	0.8	1500	Functional	Figure 39
TGAD-292NARL	Halo Electronics	1CT:5CT	14	389	0.8	1500	Functional	Figure 40

## TRANSFORMER ET CONSTANT

The next transformer design factor to consider is the ET constant. This constant determines the minimum  $V \times \mu\text{s}$  constant of the transformer over the operating temperature. ET values of  $14 V \times \mu\text{s}$  and  $18 V \times \mu\text{s}$  were selected for the ADuM347x transformer designs listed in Table 18 using the following equation:

$$ET(MIN) = \frac{V_{DD1(MAX)}}{f_{SW(MIN)} \times 2}$$

where:

$V_{DD1(MAX)}$  is the maximum input supply voltage.

$f_{SW(MIN)}$  is the minimum primary switching frequency = 300 kHz in startup.

2 is a multiplier factor used for the push-pull switching cycle.

## TRANSFORMER PRIMARY INDUCTANCE AND RESISTANCE

Another important characteristic of the transformer for designs with the ADuM347x is the primary inductance. Transformers for the ADuM347x are recommended to have between 60  $\mu\text{H}$  to 100  $\mu\text{H}$  of inductance per primary winding. Values of primary inductance in this range are needed for smooth operation of the ADuM347x pulse-by-pulse current-limit circuit, which can help protect against a build-up of saturation currents in the transformer. If the inductance is specified for the total of both primary windings, for example, as 400  $\mu\text{H}$ , the inductance of one winding is one-fourth of two equal windings, or 100  $\mu\text{H}$ .

Another important characteristic of the transformer for designs with the ADuM347x is primary resistance. Primary resistance as low as is practical (less than 1  $\Omega$ ) helps to reduce losses and improves efficiency. The dc primary resistance can be measured and specified, and is shown for the transformers in Table 18.

## TRANSFORMER ISOLATION VOLTAGE

Isolation voltage and isolation type should be determined for the requirements of the application and then specified. The transformers in Table 18 have been specified for 2500 V rms for supplemental or basic isolation and for 1500 V rms functional isolation. Other isolation levels and isolation voltages can be specified and requested from the transformer manufacturers listed in Table 18 or from other manufacturers.

## SWITCHING FREQUENCY

The ADuM347x switching frequency can be adjusted from 200 kHz to 1 MHz by changing the value of the  $R_{OC}$  resistor shown in Figure 38, Figure 39, and Figure 40. The value of the  $R_{OC}$  resistor needed for the desired switching frequency can be determined from the switching frequency vs.  $R_{OC}$  resistance curve shown in Figure 9. The output filter inductor value and output capacitor value for the ADuM347x application schematics have been designed to be stable over the switching frequency range of 500 kHz to 1 MHz, when loaded from 10% to 90% of the maximum load.

The ADuM347x devices also have an open-loop mode where the output voltage is not regulated and is dependent on the transformer turns ratio,  $N_S/N_P$ , and the conditions of the output including output load current and the losses in the dc-to-dc converter circuit. This open-loop mode is selected when the OC pin is connected high to the  $V_{DD2}$  pin. In open-loop mode, the switching frequency is 318 kHz.

## TRANSIENT RESPONSE

The load transient response of the ADuM347x output voltage for 10% to 90% of the full load is shown in Figure 30 to Figure 33 for the application schematics in Figure 38 and Figure 39. The response shown is slow but stable and can have more output change than desired for some applications. The output voltage change with load transient is reduced, and the output is shown to remain stable by adding more inductance to the output circuits, as shown in the second  $V_{ISO}$  output waveform in Figure 30 to Figure 33. For additional improvement in transient response, add a 0.1  $\mu\text{F}$  ceramic capacitor ( $C_{FB}$ ) in parallel with the high feedback resistor. This value helps to reduce the overshoot and undershoot during load transients.

## COMPONENT SELECTION

The ADuM347x digital isolators with 2 W dc-to-dc converters require no external interface circuitry for the logic interfaces. Power supply bypassing is required at the input and output supply pins. Note that a low ESR ceramic bypass capacitor of 0.1  $\mu\text{F}$  is required on Side 1 between Pin 9 and Pin 10, and on Side 2 between Pin 18 and Pin 19, as close to the chip pads as possible.

The power supply section of the ADuM347x uses a high oscillator frequency to efficiently pass power through the external power transformer. In addition, normal operation of the data section of the iCoupler introduces switching transients on the power supply pins. Bypass capacitors are required for several operating frequencies. Noise suppression requires a low inductance, high frequency capacitor; ripple suppression and proper regulation require a large value capacitor. To suppress noise and reduce ripple, large value ceramic capacitors of X5R or X7R dielectric type are recommended. The recommended capacitor value is 10  $\mu\text{F}$  for  $V_{DD1}$  and 47  $\mu\text{F}$  for  $V_{ISO}$ . These capacitors have a low ESR and are available in moderate 1206 or 1210 sizes for voltages up to 10 V. For output voltages larger than 10 V, two 22  $\mu\text{F}$  ceramic capacitors can be used in parallel. See Table 19 for recommended components.

Table 19. Recommended Components

Part No.	Manufacturer	Value
GRM32ER71A476KE15L	Murata	47 $\mu\text{F}$ , 10 V, X7R, 1210
GRM32ER71C226KEA8L	Murata	22 $\mu\text{F}$ , 16 V, X7R, 1210
GRM31CR71A106KA01L	Murata	10 $\mu\text{F}$ , 10 V, X7R, 1206
MBR0540T1G	ON Semiconductor	Schottky, 0.5 A, 40 V, SOD-123
LQH3NPN470MM0	Murata	47 $\mu\text{H}$ , 0.41 A, 1212
ME3220-104KL	Coilcraft	100 $\mu\text{H}$ , 0.34 A, 1210
LQH6PPN470M43	Murata	47 $\mu\text{H}$ , 1.10 A, 2424
LQH6PPN101M43	Murata	100 $\mu\text{H}$ , 0.80 A, 2424

Inductors must be selected based on the value and supply current needed. Most applications with switching frequencies between 500 kHz and 1 MHz and load transients between 10% and 90% of full load are stable with the 47  $\mu\text{H}$  inductor value listed in Table 19. Values as large as 200  $\mu\text{H}$  can be used for power supply applications with a switching frequency as low as 200 kHz to help stabilize the output voltage or for improved load transient response (see Figure 30 to Figure 33). Inductors in a small 1212 or 1210 size are listed in Table 19 with a 47  $\mu\text{H}$  value and a 0.41 A current rating to handle the majority of applications below a 400 mA load, and with a 100  $\mu\text{H}$  value and a 0.34 A current rating to handle a load up to 300 mA.

Recommended Schottky diodes have low forward voltage to reduce losses and high reverse voltage of up to 40 V to withstand the peak voltages available in the doubling circuits shown in Figure 39 and Figure 40.

**PRINTED CIRCUIT BOARD (PCB) LAYOUT**

Figure 41 shows the recommended PCB layout for the ADuM347x. Note that the total lead length between the ends of the low ESR capacitor and the  $V_{\text{DDx}}$  and  $\text{GND}_x$  pins must not exceed 2 mm. Installing a bypass capacitor with traces more than 2 mm in length can result in data corruption.



Figure 41. Recommended PCB Layout

In applications that involve high common-mode transients, ensure that board coupling across the isolation barrier is minimized. Furthermore, design the board layout such that any coupling that does occur affects all pins equally on a given component side. Failure to ensure this can cause voltage differentials between pins that exceed the absolute maximum ratings specified in Table 10, thereby leading to latch-up and/or permanent damage.

The ADuM3470/ADuM3471/ADuM3472/ADuM3473/ADuM3474 are power devices that dissipate approximately 1 W of power when fully loaded and running at maximum speed. Because it is not possible to apply a heat sink to an isolation device, the devices primarily depend on heat dissipation into the PCB through the  $\text{GND}_x$  pins. If the devices are used at high ambient temperatures, provide a thermal path from the  $\text{GND}_x$  pins to the PCB ground plane.

The board layout in Figure 41 shows enlarged pads for Pin 2 and Pin 10 ( $\text{GND}_1$ ) on Side 1 and Pin 11 and Pin 19 ( $\text{GND}_2$ ) on Side 2. Large diameter vias should be implemented from the pad to the ground planes and power planes to increase thermal conductivity and to reduce inductance. Multiple vias in the thermal pads can significantly reduce temperatures inside the chip. The dimensions of the expanded pads are left to the discretion of the designer and depend on the available board space.

**THERMAL ANALYSIS**

The ADuM347x parts consist of two internal die attached to a split lead frame with two die attach paddles. For the purposes of thermal analysis, the die are treated as a thermal unit, with the highest junction temperature reflected in the  $\theta_{\text{JA}}$  value from Table 5. The value of  $\theta_{\text{JA}}$  is based on measurements taken with the parts mounted on a JEDEC standard, 4-layer board with fine width traces and still air.

Under normal operating conditions, the ADuM347x devices operate at full load across the full temperature range without derating the output current. However, following the recommendations in the Printed Circuit Board (PCB) Layout section decreases thermal resistance to the PCB, allowing increased thermal margins at high ambient temperatures.

The ADuM347x devices have a thermal shutdown circuit that shuts down the dc-to-dc converter and the outputs of the ADuM347x when a die temperature of approximately 160°C is reached. When the die cools below approximately 140°C, the ADuM347x dc-to-dc converter and outputs turn on again.

**PROPAGATION DELAY-RELATED PARAMETERS**

Propagation delay is a parameter that describes the length of time it takes for a logic signal to propagate through a component (see Figure 42). The propagation delay to a logic low output can differ from the propagation delay to a logic high output.

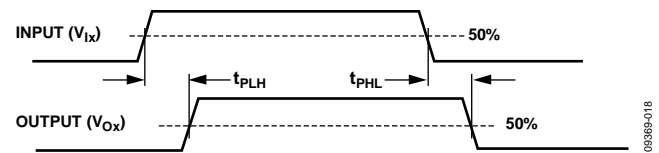

Figure 42. Propagation Delay Parameters

Pulse width distortion is the maximum difference between these two propagation delay values and is an indication of how accurately the timing of the input signal is preserved.

Channel-to-channel matching refers to the maximum amount that the propagation delay differs between channels within a single ADuM347x component.

Propagation delay skew refers to the maximum amount that the propagation delay differs between multiple ADuM347x components operating under the same conditions.

**DC CORRECTNESS AND MAGNETIC FIELD IMMUNITY**

Positive and negative logic transitions at the isolator input cause narrow (~1 ns) pulses to be sent to the decoder via the transformer. The decoder is bistable and is, therefore, either set or reset by the pulses, indicating input logic transitions. In the absence of logic transitions at the input for more than 1 μs, periodic sets of refresh pulses indicative of the correct input state are sent to ensure dc correctness at the output. If the decoder receives no internal pulses for more than approximately 5 μs, the input side is assumed to be unpowered or nonfunctional, and the isolator output is forced to a default state by the watchdog timer circuit (see Table 17). This situation should occur in the ADuM347x devices only during power-up and power-down operations.

The limitation on the magnetic field immunity of the ADuM347x is set by the condition in which induced voltage in the transformer receiving coil is sufficiently large to either falsely set or reset the decoder. The following analysis defines the conditions under which this can occur.

The 3.3 V operating condition of the ADuM347x is examined because it represents the most susceptible mode of operation.

The pulses at the transformer output have an amplitude of >1.0 V. The decoder has a sensing threshold of approximately 0.5 V, thus establishing a 0.5 V margin in which induced voltages can be tolerated. The voltage induced across the receiving coil is given by

$$V = (-d\beta/dt) \sum \pi r_n^2; n = 1, 2, \dots, N$$

where:

$\beta$  is the magnetic flux density (gauss).

$r_n$  is the radius of the  $n^{\text{th}}$  turn in the receiving coil (cm).

$N$  is the number of turns in the receiving coil.

Given the geometry of the receiving coil in the ADuM347x and an imposed requirement that the induced voltage be, at most, 50% of the 0.5 V margin at the decoder, a maximum allowable magnetic field is calculated as shown in Figure 43.



Figure 43. Maximum Allowable External Magnetic Flux Density

For example, at a magnetic field frequency of 1 MHz, the maximum allowable magnetic field of 0.2 kgauss induces a voltage of 0.25 V at the receiving coil. This voltage is approximately 50% of the sensing threshold and does not cause a faulty output transition. Similarly, if such an event occurs during a transmitted pulse (and is of the worst-case polarity), it reduces the received pulse from >1.0 V to 0.75 V—still well above the 0.5 V sensing threshold of the decoder.

The preceding magnetic flux density values correspond to specific current magnitudes at given distances from the ADuM347x transformers. Figure 44 expresses these allowable current magnitudes as a function of frequency for selected distances. As shown in Figure 44, the ADuM347x is extremely immune and can be affected only by extremely large currents operated at high frequency very close to the component. For the 1 MHz example, a 0.5 kA current must be placed 5 mm away from the ADuM347x to affect the operation of the component.



Figure 44. Maximum Allowable Current for Various Current-to-ADuM347x Spacings

At combinations of strong magnetic field and high frequency, any loops formed by PCB traces can induce error voltages sufficiently large to trigger the thresholds of succeeding circuitry. Care should be taken in the layout of such traces to avoid this possibility.

## POWER CONSUMPTION

The  $V_{DD1}$  power supply provides power to the *iCoupler* data channels, as well as to the power converter. For this reason, the quiescent currents drawn by the power converter and the primary and secondary I/O channels cannot be determined separately. All of these quiescent power demands are combined in the  $I_{DD1(Q)}$  current (see the simplified diagram in Figure 45). The total  $I_{DD1}$  supply current is equal to the sum of the quiescent operating current; the dynamic current,  $I_{DD1(D)}$ , demanded by the I/O channels; and any external  $I_{ISO}$  load.



Figure 45. Power Consumption Within the ADuM347x

Dynamic I/O current is consumed only when operating a channel at speeds higher than the refresh rate of  $f_r$ . The dynamic current of each channel is determined by its data rate. Figure 18 and Figure 22 show the current for a channel in the forward direction, meaning that the input is on the primary side of the part. Figure 19 and Figure 23 show the current for a channel in the reverse direction, meaning that the input is on the secondary side of the part. Figure 18, Figure 19, Figure 22, and Figure 23 assume a typical 15 pF output load.

The following relationship allows the total  $I_{DD1}$  current to be

$$I_{DD1} = (I_{ISO} \times V_{ISO}) / (E \times V_{DD1}) + \sum I_{CHn}; n = 1 \text{ to } 4 \quad (1)$$

where:

$I_{DD1}$  is the total supply input current.

$I_{ISO}$  is the current drawn by the secondary side external load.

$E$  is the power supply efficiency at the given output load from

Figure 13 or Figure 17 at the  $V_{ISO}$  and  $V_{DD1}$  condition of interest.

$I_{CHn}$  is the current drawn by a single channel, determined from Figure 18, Figure 19, Figure 22, or Figure 23, depending on channel direction.

The maximum external load can be calculated by subtracting the dynamic output load from the maximum allowable load.

$$I_{ISO(LOAD)} = I_{ISO(MAX)} - \sum I_{ISO(D)n}; n = 1 \text{ to } 4 \quad (2)$$

where:

$I_{ISO(LOAD)}$  is the current available to supply an external secondary side load.

$I_{ISO(MAX)}$  is the maximum external secondary side load current available at  $V_{ISO}$ .

$I_{ISO(D)n}$  is the dynamic load current drawn from  $V_{ISO}$  by an output or input channel, as shown for a single supply in Figure 20 or Figure 21 or for a double supply in Figure 24 or Figure 25.

The preceding analysis assumes a 15 pF capacitive load on each data output. If the capacitive load is larger than 15 pF, the additional current must be included in the analysis of  $I_{DD1}$  and  $I_{ISO(LOAD)}$ .

## POWER CONSIDERATIONS

### Soft Start Mode and Current-Limit Protection

When the ADuM347x device first receives power from  $V_{DD1}$ , it is in soft start mode, and the output voltage,  $V_{ISO}$ , is increased gradually while it is below the start-up threshold. In soft start mode, the width of the PWM signal is increased gradually by the primary converter to limit the peak current during  $V_{ISO}$  power-up. When the output voltage is larger than the start-up threshold, the PWM signal can be transferred from the secondary controller to the primary converter, and the dc-to-dc converter switches from soft start mode to the normal PWM control mode.

If a short circuit occurs, the push-pull converter shuts down for approximately 2 ms and then enters soft start mode. If, at the end of soft start, a short circuit still exists, the process is repeated, which is called hiccup mode. If the short circuit is cleared, the ADuM347x device enters normal operation.

The ADuM347x devices also have a pulse-by-pulse current limit, which is active in startup and normal operation. This current limit protects the primary switches, X1 and X2, from exceeding approximately 1.2 A peak and also protects the transformer windings.

### Data Channel Power Cycle

The ADuM347x data input channels on the primary side and the data input channels on the secondary side are protected from premature operation by UVLO circuitry. Below the minimum operating voltage, the power converter holds its oscillator inactive, and all input channel drivers and refresh circuits are idle. Outputs are held in a low state to prevent transmission of undefined states during power-up and power-down operations.

During application of power to  $V_{DD1}$ , the primary side circuitry is held idle until the UVLO preset voltage is reached. At that time, the data channels are initialized to their default low output state until they receive data pulses from the secondary side.

The primary side input channels sample the input and send a pulse to the inactive secondary output. The secondary side converter begins to accept power from the primary, and the  $V_{ISO}$  voltage starts to rise. When the secondary side UVLO is reached, the secondary side outputs are initialized to their default low state until data, either a transition or a dc refresh pulse, is received from the corresponding primary side input. It can take up to 1  $\mu$ s after the secondary side is initialized for the state of the output to correlate with the primary side input.

Secondary side inputs sample their state and transmit it to the primary side. Outputs are valid one propagation delay after the secondary side becomes active.

Because the rate of charge of the secondary side is dependent on the soft start cycle, loading conditions, input voltage, and output voltage level selected, care should be taken in the design to allow the converter to stabilize before valid data is required.

When power is removed from  $V_{DD1}$ , the primary side converter and coupler shut down when the UVLO level is reached. The secondary side stops receiving power and starts to discharge. The outputs on the secondary side hold the last state that they received from the primary side until either the UVLO level is reached and the outputs are placed in their default low state, or the outputs detect a lack of activity from the inputs and the outputs are set to their default value before the secondary power reaches UVLO.

### INSULATION LIFETIME

All insulation structures eventually break down when subjected to voltage stress over a sufficiently long period. The rate of insulation degradation is dependent on the characteristics of the voltage waveform applied across the insulation. Analog Devices conducts an extensive set of evaluations to determine the lifetime of the insulation structure within the ADuM347x devices.

Accelerated life testing is performed using voltage levels higher than the rated continuous working voltage. Acceleration factors for several operating conditions are determined, allowing calculation of the time to failure at the working voltage of interest. The values shown in Table 11 summarize the peak voltages for 50 years of service life in several operating conditions. In many cases, the working voltage approved by agency testing is higher than the 50-year service life voltage. Operation at working voltages higher than the service life voltage listed in Table 11 leads to premature insulation failure.

The insulation lifetime of the ADuM347x depends on the voltage waveform type imposed across the isolation barrier. The iCoupler insulation structure degrades at different rates, depending on whether the waveform is bipolar ac, dc, or unipolar ac. Figure 46, Figure 47, and Figure 48 illustrate these different isolation voltage waveforms.

Bipolar ac voltage is the most stringent environment. A 50-year operating lifetime under the bipolar ac condition determines the maximum working voltage recommended by Analog Devices.

In the case of unipolar ac or dc voltage, the stress on the insulation is significantly lower. This allows operation at higher working voltages while still achieving a 50-year service life. The working voltages listed in Table 11 can be applied while maintaining the 50-year minimum lifetime, provided that the voltage conforms to either the unipolar ac or dc voltage cases. Treat any cross-insulation voltage waveform that does not conform to Figure 47 or Figure 48 as a bipolar ac waveform, and limit its peak voltage to the 50-year lifetime voltage value listed in Table 11.

The voltage presented in Figure 48 is shown as sinusoidal for illustration purposes only. It is meant to represent any voltage waveform varying between 0 V and some limiting value. The limiting value can be positive or negative, but the voltage cannot cross 0 V.



Figure 46. Bipolar AC Waveform



Figure 47. DC Waveform



Figure 48. Unipolar AC Waveform

OUTLINE DIMENSIONS



COMPLIANT TO JEDEC STANDARDS MO-150-AE

Figure 49. 20-Lead Shrink Small Outline Package [SSOP] (RS-20)

Dimensions shown in millimeters

060106-A



## ORDERING GUIDE

Model <sup>1, 2, 3</sup>	Number of Inputs, V <sub>DD1</sub> Side	Number of Inputs, V <sub>ISO</sub> Side	Maximum Data Rate (Mbps)	Maximum Propagation Delay, 5 V (ns)	Maximum Pulse Width Distortion (ns)	Temperature Range (°C)	Package Description	Package Option
ADuM3470ARSZ	4	0	1	100	40	-40 to +105	20-Lead SSOP	RS-20
ADuM3470CRSZ	4	0	25	60	8	-40 to +105	20-Lead SSOP	RS-20
ADuM3470WARSZ	4	0	1	100	40	-40 to +105	20-Lead SSOP	RS-20
ADuM3470WCRSZ	4	0	25	60	8	-40 to +105	20-Lead SSOP	RS-20
ADuM3471ARSZ	3	1	1	100	40	-40 to +105	20-Lead SSOP	RS-20
ADuM3471CRSZ	3	1	25	60	8	-40 to +105	20-Lead SSOP	RS-20
ADuM3471WARSZ	3	1	1	100	40	-40 to +105	20-Lead SSOP	RS-20
ADuM3471WCRSZ	3	1	25	60	8	-40 to +105	20-Lead SSOP	RS-20
ADuM3472ARSZ	2	2	1	100	40	-40 to +105	20-Lead SSOP	RS-20
ADuM3472CRSZ	2	2	25	60	8	-40 to +105	20-Lead SSOP	RS-20
ADuM3472WARSZ	2	2	1	100	40	-40 to +105	20-Lead SSOP	RS-20
ADuM3472WCRSZ	2	2	25	60	8	-40 to +105	20-Lead SSOP	RS-20
ADuM3473ARSZ	1	3	1	100	40	-40 to +105	20-Lead SSOP	RS-20
ADuM3473CRSZ	1	3	25	60	8	-40 to +105	20-Lead SSOP	RS-20
ADuM3473WARSZ	1	3	1	100	40	-40 to +105	20-Lead SSOP	RS-20
ADuM3473WCRSZ	1	3	25	60	8	-40 to +105	20-Lead SSOP	RS-20
ADuM3474ARSZ	0	4	1	100	40	-40 to +105	20-Lead SSOP	RS-20
ADuM3474CRSZ	0	4	25	60	8	-40 to +105	20-Lead SSOP	RS-20
ADuM3474WARSZ	0	4	1	100	40	-40 to +105	20-Lead SSOP	RS-20
ADuM3474WCRSZ	0	4	25	60	8	-40 to +105	20-Lead SSOP	RS-20

<sup>1</sup> Z = RoHS Compliant Part.

<sup>2</sup> W = Qualified for Automotive Applications.

<sup>3</sup> Tape and reel are available. The addition of an RL7 suffix designates a 7" (500 units) tape and reel option.

## AUTOMOTIVE PRODUCTS

The [ADuM3470W](#), [ADuM3471W](#), [ADuM3472W](#), [ADuM3473W](#), and [ADuM3474W](#) models are available with controlled manufacturing to support the quality and reliability requirements of automotive applications. Note that these automotive models may have specifications that differ from the commercial models; therefore, designers should review the Specifications section of this data sheet carefully. Only the automotive grade products shown are available for use in automotive applications. Contact your local Analog Devices account representative for specific product ordering information and to obtain the specific Automotive Reliability reports for these models.

**NOTES**

**NOTES**

NOTES

Компания «Life Electronics» занимается поставками электронных компонентов импортного и отечественного производства от производителей и со складов крупных дистрибьюторов Европы, Америки и Азии.

С конца 2013 года компания активно расширяет линейку поставок компонентов по направлению коаксиальный кабель, кварцевые генераторы и конденсаторы (керамические, пленочные, электролитические), за счёт заключения дистрибьюторских договоров

Мы предлагаем:

- Конкурентоспособные цены и скидки постоянным клиентам.
- Специальные условия для постоянных клиентов.
- Подбор аналогов.
- Поставку компонентов в любых объемах, удовлетворяющих вашим потребностям.
- Приемлемые сроки поставки, возможна ускоренная поставка.
- Доставку товара в любую точку России и стран СНГ.
- Комплексную поставку.
- Работу по проектам и поставку образцов.
- Формирование склада под заказчика.
- Сертификаты соответствия на поставляемую продукцию (по желанию клиента).
- Тестирование поставляемой продукции.
- Поставку компонентов, требующих военную и космическую приемку.
- Входной контроль качества.
- Наличие сертификата ISO.

В составе нашей компании организован Конструкторский отдел, призванный помогать разработчикам, и инженерам.

Конструкторский отдел помогает осуществить:

- Регистрацию проекта у производителя компонентов.
- Техническую поддержку проекта.
- Защиту от снятия компонента с производства.
- Оценку стоимости проекта по компонентам.
- Изготовление тестовой платы монтаж и пусконаладочные работы.



Тел: +7 (812) 336 43 04 (многоканальный)

Email: [org@lifeelectronics.ru](mailto:org@lifeelectronics.ru)