

| LOC | DIST | REVISIONS | | | |
|-----|------|-----------------------------------|-----------|-----|------|
| P | LTN | DESCRIPTION | DATE | DMN | APVD |
| E1 | | ADD 3-6450140-4 | 02APR2011 | OL | SZ |
| E2 | | REV PER ECR-11-008606 | 29APR2011 | OL | SZ |
| E3 | | ADDED NEW DASH NUMBER 3-5 AND 3-6 | 09MAR2012 | CZ | SZ |
| E4 | | REVISED | 23APR2012 | CZ | SZ |

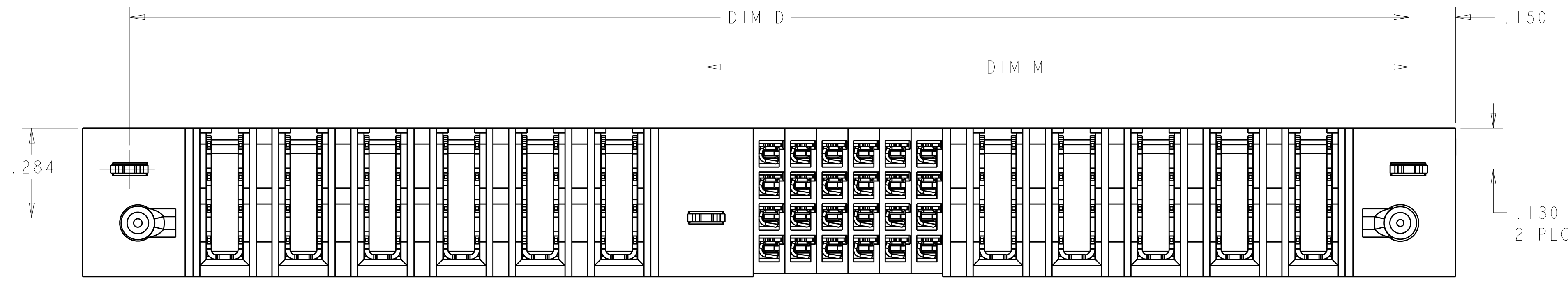

- 1 OPTIONAL CENTER MODULE, WITH Ø.150 THRU HOLE OR HOLD DOWN FEATURE
- 2 "AMP", TRADEMARK, PART NUMBER AND DATE CODE TO BE MARKED IN AREA SHOWN.
- 3 MATERIAL: HOUSING - GLASS FILLED HIGH TEMP THERMO PLASTIC, UL94 V-0
SIGNAL CONTACT - HIGH CONDUCTIVITY COPPER ALLOY
POWER CONTACT - HIGH CONDUCTIVITY COPPER ALLOY
- 4 CONTACT PLATING: NOBLE METAL PLATING ON CONTACT FUNCTIONAL AREA OF POWER AND SIGNAL CONTACTS
- 5 MECHANICAL CONNECTOR KEEP OUT ZONE
- 6 DATUM AND BASIC DIMENSIONS ESTABLISHED BY CUSTOMER
- 7 PCB - ALL HOLE DIAMETERS ARE FINISHED HOLE SIZES
- 8 PCB - .0453±.0010 DRILLED HOLES PLATED WITH .0003 MIN Sn OVER .001 TO .003 Cu PLATING TO ACHIEVE A .040 HOLE

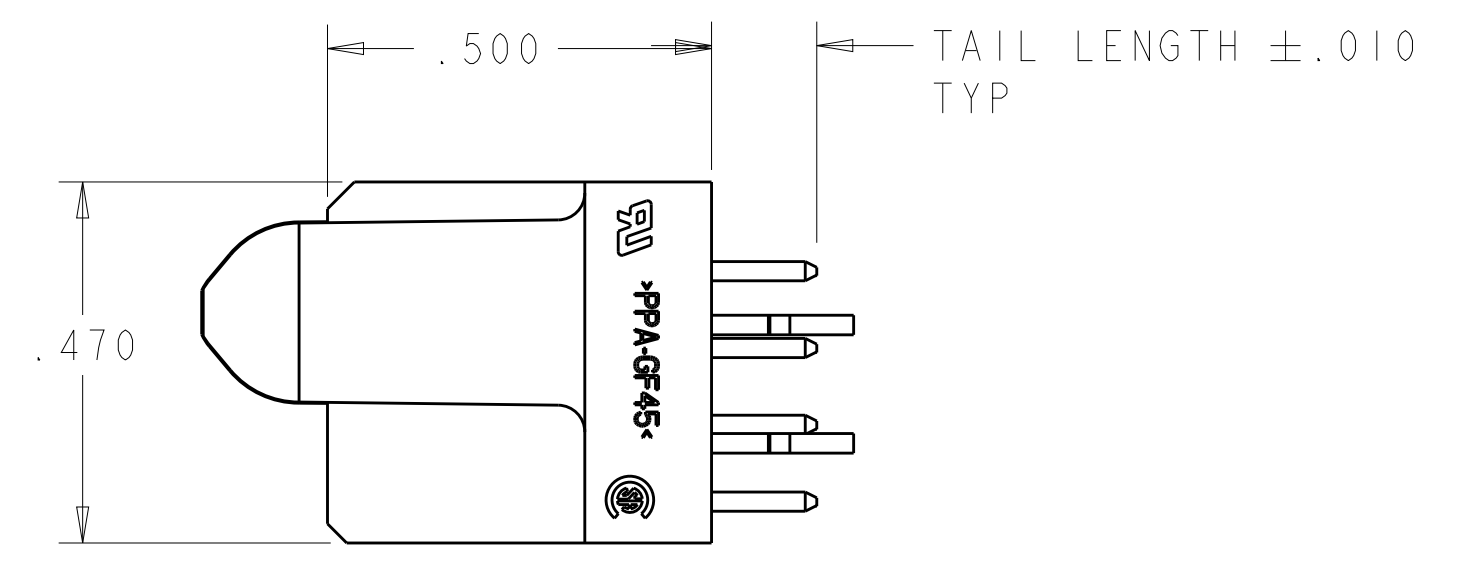
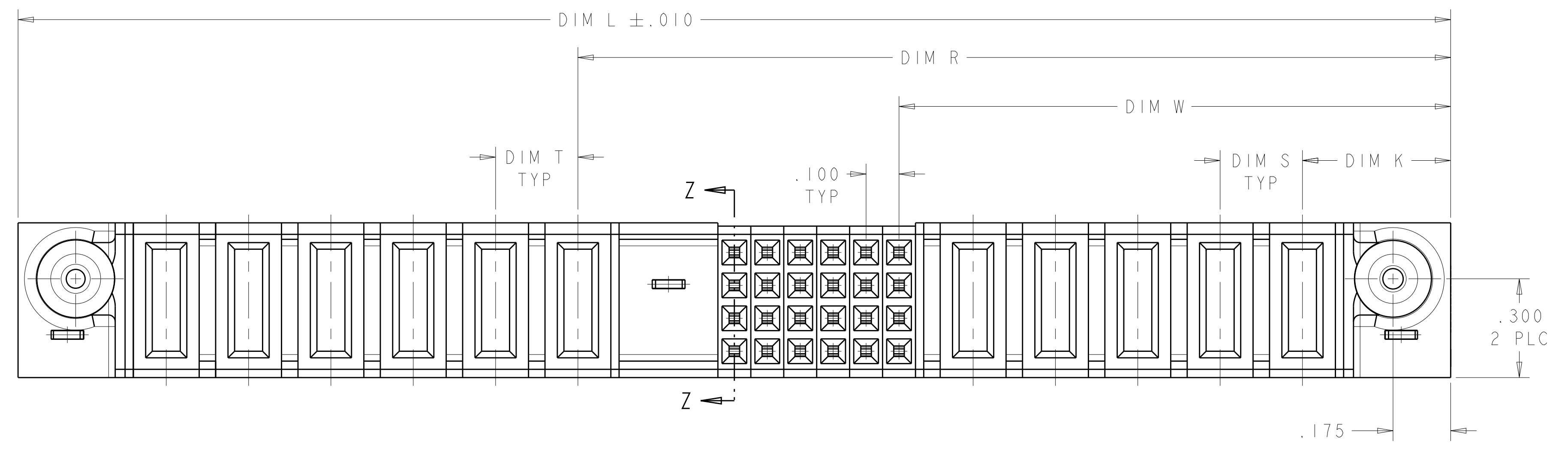
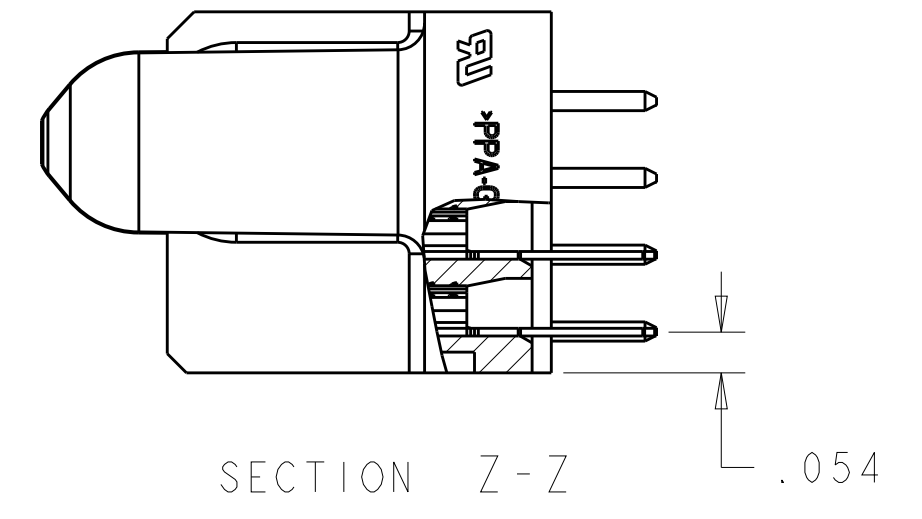
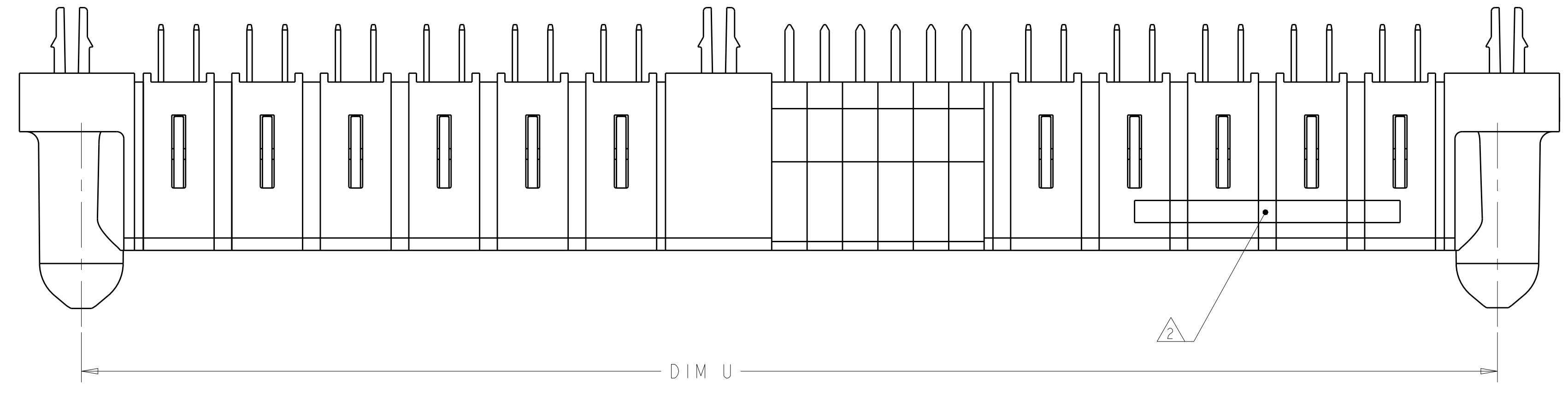

| | | | |
|--|-------------|-----------------------------|--|
| THIS DRAWING IS A CONTROLLED DOCUMENT. | | DMN: R.GRZYBOWSKI 15FEB05 | TE Connectivity |
| DIMENSIONS: INCHES | | CHK: M.PERCHEKKE 15FEB05 | |
| TOLERANCES UNLESS OTHERWISE SPECIFIED: | | APVD: M.PERCHEKKE | NAME: VERTICAL RECEPTACLE ASSEMBLY WITH GUIDES MULTI-BEAM XL |
| 0 PLC ±.01 | 1 PLC ±.01 | PRODUCT SPEC: 108-1973 | SIZE: A1 |
| 2 PLC ±.005 | 3 PLC ±.005 | APPLICATION SPEC: 114-13038 | CAGE CODE: C=6450140 |
| 4 PLC ±.0020 | ANGLES ±.7° | WEIGHT: - | RESTRICTED TO: - |
| MATERIAL: 3 | FINISH: 4 | CUSTOMER DRAWING | SCALE: 2:1 SHEET 1 OF 11 REV: E4 |

THIS DRAWING IS UNPUBLISHED. RELEASED FOR PUBLICATION 20
 © COPYRIGHT 20 BY - ALL RIGHTS RESERVED.

| LOC | DIST | REVISIONS | | | | | |
|-----|------|-----------|-----|-------------|------|-----|------|
| | | P | LTN | DESCRIPTION | DATE | OWN | APVD |
| ES | 00 | - | - | SEE SHEET 1 | - | - | - |
| | | | | | | | |
| | | | | | | | |

| | | | | | | | | | | |
|-------|------|------|-------|-------|-------|-------|-------|------|-------------------|-------------|
| 1.575 | - | - | 1.425 | .700 | 1.625 | - | 1.925 | .475 | 1P + 24S + 1P | 3-6450140-6 |
| 1.575 | - | - | 1.425 | .700 | 1.625 | - | 1.925 | .475 | 1P + 24S + 1P | 3-6450140-5 |
| 2.700 | .250 | .250 | 2.100 | 1.125 | 2.750 | - | 3.050 | .450 | 3P + 36S + 3P | 3-6450140-4 |
| 3.200 | .250 | .250 | 2.350 | 1.375 | 3.250 | - | 3.550 | .450 | 4P + 36S + 4P | 3-6450140-1 |
| 3.500 | .250 | .250 | 2.150 | 1.875 | 3.550 | - | 3.850 | .450 | 6P + 8S + 6P | 3-6450140-0 |
| 2.500 | .250 | .250 | 1.650 | 1.375 | 2.550 | - | 2.850 | .450 | 4P + 8S + 4P | 2-6450140-9 |
| 2.900 | .250 | .250 | 2.050 | 1.375 | 2.950 | - | 3.250 | .450 | 4P + 24S + 4P | 2-6450140-8 |
| 2.400 | .250 | .250 | 2.050 | 1.375 | 2.450 | - | 2.750 | .450 | 4P + 24S + 2P | 2-6450140-7 |
| 3.700 | .300 | .200 | 2.700 | 2.025 | 3.750 | - | 4.050 | .450 | 8P + 24S + 4ACP | 2-6450140-6 |
| 2.400 | .250 | .250 | 1.800 | 1.125 | 2.450 | - | 2.750 | .450 | 3P + 24S + 3P | 2-6450140-5 |
| 1.900 | .250 | .250 | 1.550 | .875 | 1.950 | - | 2.250 | .450 | 2P + 24S + 2P | 2-6450140-0 |
| 2.600 | .200 | .200 | 1.900 | 1.225 | 2.650 | - | 2.950 | .450 | 4HDP + 24S + 4HDP | 1-6450140-9 |
| 1.700 | .250 | .250 | 1.350 | .875 | 1.750 | - | 2.050 | .450 | 2P + 16S + 2P | 1-6450140-8 |
| 4.500 | .250 | .250 | 2.900 | 2.125 | 4.550 | - | 4.850 | .450 | 7P + 28S + 7P | 1-6450140-3 |
| 4.250 | .250 | .250 | 2.650 | 1.875 | 4.300 | - | 4.600 | .450 | 6P + 28S + 7P | 1-6450140-2 |
| 2.800 | .250 | .250 | 1.950 | 1.375 | 2.850 | - | 3.150 | .450 | 4P + 20S + 4P | 1-6450140-1 |
| 2.400 | .250 | .250 | 1.800 | 1.125 | 2.450 | - | 2.750 | .450 | 3P + 24S + 3P | 1-6450140-0 |
| 4.000 | .250 | .250 | 2.650 | 1.675 | 4.050 | 2.225 | 4.350 | .450 | 5P+24S+1M+6P | 6450140-9 |
| 4.150 | .250 | .250 | 2.800 | 2.125 | 4.200 | - | 4.500 | .450 | 7P + 24S + 6P | 6450140-8 |
| 4.350 | .250 | .250 | 3.500 | 2.625 | 4.400 | - | 4.700 | .450 | 9P + 32S + 4P | 6450140-7 |
| 1.575 | - | - | 1.425 | .700 | 1.625 | - | 1.925 | .475 | 1P + 24S + 1P | 6450140-6 |
| 1.900 | .250 | .250 | 1.550 | .875 | 1.950 | - | 2.250 | .450 | 2P + 24S + 2P | 6450140-5 |
| 7.400 | .250 | .250 | 5.050 | 2.875 | 7.450 | - | 7.750 | .450 | 10P + 84S + 10P | 6450140-4 |
| 3.650 | .250 | .250 | 2.550 | 1.875 | 3.700 | - | 4.000 | .450 | 6P + 24S + 5P | 6450140-3 |
| 4.350 | .250 | .250 | 3.000 | 2.125 | 4.400 | - | 4.700 | .450 | 7P + 32S + 6P | 6450140-2 |
| 5.100 | .250 | .250 | 3.250 | 2.375 | 5.150 | - | 5.450 | .450 | 8P + 32S + 8P | 6450140-1 |
| U | T | S | R | W | D | M | L | K | DESCRIPTION | PART NUMBER |

E3

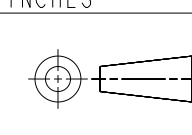
| | | | | |
|---|--|---|--------------------------------|---|
| THIS DRAWING IS A CONTROLLED DOCUMENT. | | OWN R. GRZYBOWSKI CHK M. PERCHERKE APVD M. PERCHERKE | 15FEB05 15FEB05 |  TE Connectivity NAME VERTICAL RECEPTACLE ASSEMBLY WITH GUIDES MULTI-BEAM XL |
| DIMENSIONS: INCHES | TOLERANCES UNLESS OTHERWISE SPECIFIED: | PRODUCT SPEC 108-1973 | APPLICATION SPEC 114-13038 | |
|  | 0 PLC ±. 1 PLC ±.01 2 PLC ±.01 3 PLC ±.005 4 PLC ±.002 ANGLES ±.020 FINISH | RESTRICTED TO | SIZE A100779 | |
| MATERIAL | FINISH | WEIGHT | SCALE 2:1 SHEET 2 OF 11 REV E4 | |
| CUSTOMER DRAWING | | DRAWING NO. 6450140 | | |

| LOC | DIST | REVISIONS | | | |
|-----|------|-------------|------|-----|------|
| P | LTN | DESCRIPTION | DATE | DMN | APVD |
| ES | 00 | SEE SHEET 1 | | | |

| PART NUMBER | ROWS | POWER | | | | | | | SIGNAL | | | | | | | POWER | | | | | | | | |
|-------------|------------------|-------|-----|-----|-----|-----|-----|-----|--------|---|---|---|---|---|---|-------|----|----|----|----|----|----|----|----|
| | | P16 | P15 | P14 | P13 | P12 | P11 | P10 | P9 | 8 | 7 | 6 | 5 | 4 | 3 | 2 | 1 | P8 | P7 | P6 | P5 | P4 | P3 | P2 |
| 6450140-1 | D C B A | VA | VA | VA | VA | VA | VA | VA | E | E | E | E | E | E | E | E | VA | VA | VA | VA | VA | VA | VA | VA |

9P + 32S + 8P

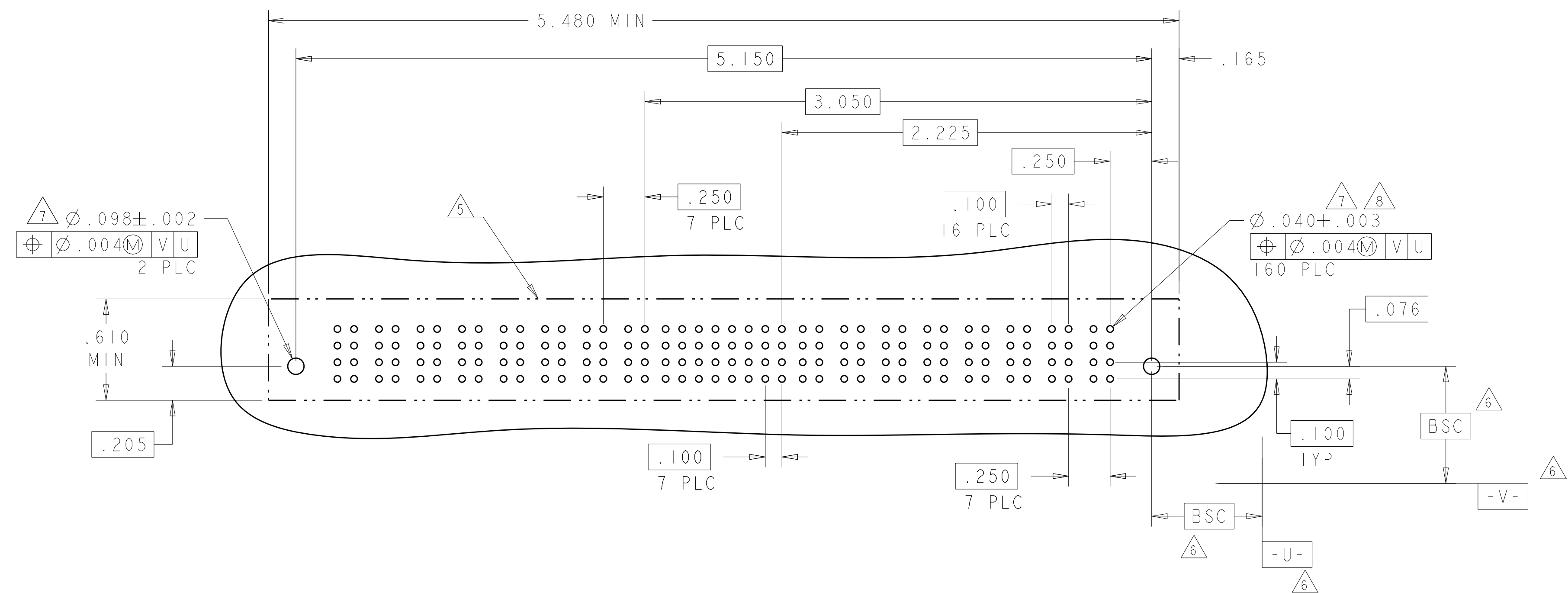

| PART NUMBER | ROWS | POWER | | | | | | | SIGNAL | | | | | | | POWER | | | | | | |
|-------------|------------------|-------|-----|-----|-----|----|----|---|--------|---|---|---|---|---|----|-------|----|----|----|----|----|----|
| | | P13 | P12 | P11 | P10 | P9 | P8 | 8 | 7 | 6 | 5 | 4 | 3 | 2 | 1 | P7 | P6 | P5 | P4 | P3 | P2 | P1 |
| 6450140-2 | D C B A | VA | VA | VA | VA | VA | VA | E | E | E | E | E | E | E | VA | VA | VA | VA | VA | VA | VA | |

7P + 32S + 6P

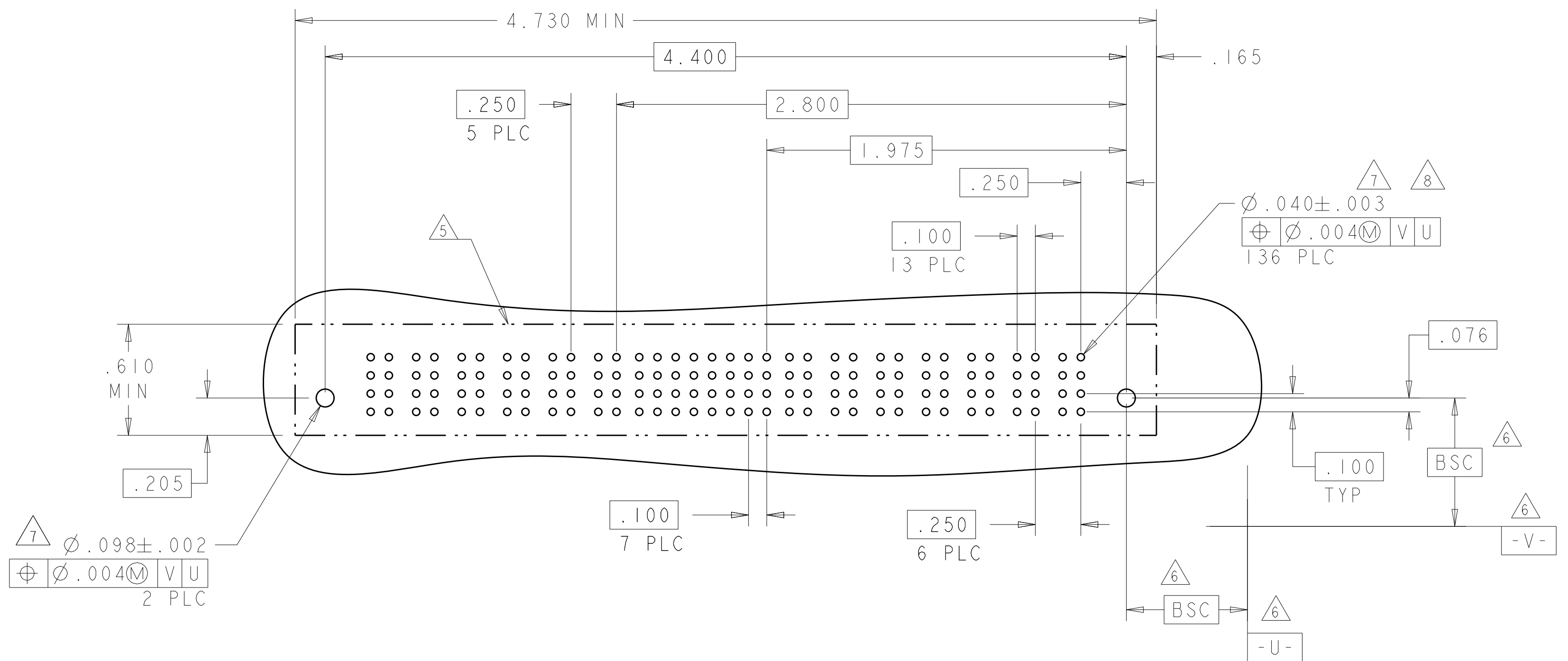

| CODE | TAIL LENGTH | DESCRIPTION |
|---------------|-------------|----------------|
| VB | .090 | MFBL |
| VM | .135 | STD |
| VA | .135 | MFBL |
| POWER CONTACT | | |
| CODE | TAIL LENGTH | SIGNAL CONTACT |
| J | .090 | |
| E | .135 | |

THIS DRAWING IS A CONTROLLED DOCUMENT. DWN: R. GRZYBOWSKI 15FEB05
 CHK: M. PERCHERKE 15FEB05

STE TE Connectivity

VERTICAL RECEPTACLE ASSEMBLY WITH GUIDES MULTI-BEAM XL

SIZE: A1 00779 C=6450140

CUSTOMER DRAWING SCALE: 2:1 SHEET 3 OF 11 REV: E4

| LOC | DIST | REVISIONS | | | |
|-----|------|-----------|------|----|------|
| ES | 00 | REV | DATE | BY | APPD |
| | | 1 | | | |
| | | 2 | | | |
| | | 3 | | | |
| | | 4 | | | |
| | | 5 | | | |
| | | 6 | | | |
| | | 7 | | | |
| | | 8 | | | |
| | | 9 | | | |
| | | 10 | | | |
| | | 11 | | | |
| | | 12 | | | |
| | | 13 | | | |
| | | 14 | | | |
| | | 15 | | | |
| | | 16 | | | |
| | | 17 | | | |
| | | 18 | | | |
| | | 19 | | | |
| | | 20 | | | |

| PART NUMBER | ROWS | POWER | | | | | SIGNAL | | | | | POWER | | | | | |
|-------------|------------------|-------|----|----|----|----|--------|----|----|----|----|-------|----|----|----|----|----|
| | | P2 | 6 | 5 | 4 | 3 | 2 | 1 | P1 | P2 | 6 | 5 | 4 | 3 | 2 | 1 | P1 |
| 6450140-6 | D C B A | VA | VA | VA | VA | VA | VA | VA | VA | VA | VA | VA | VA | VA | VA | VA | VA |
| | | VA | VA | VA | VA | VA | VA | VA | VA | VA | VA | VA | VA | VA | VA | VA | VA |

IP + 24S + IP

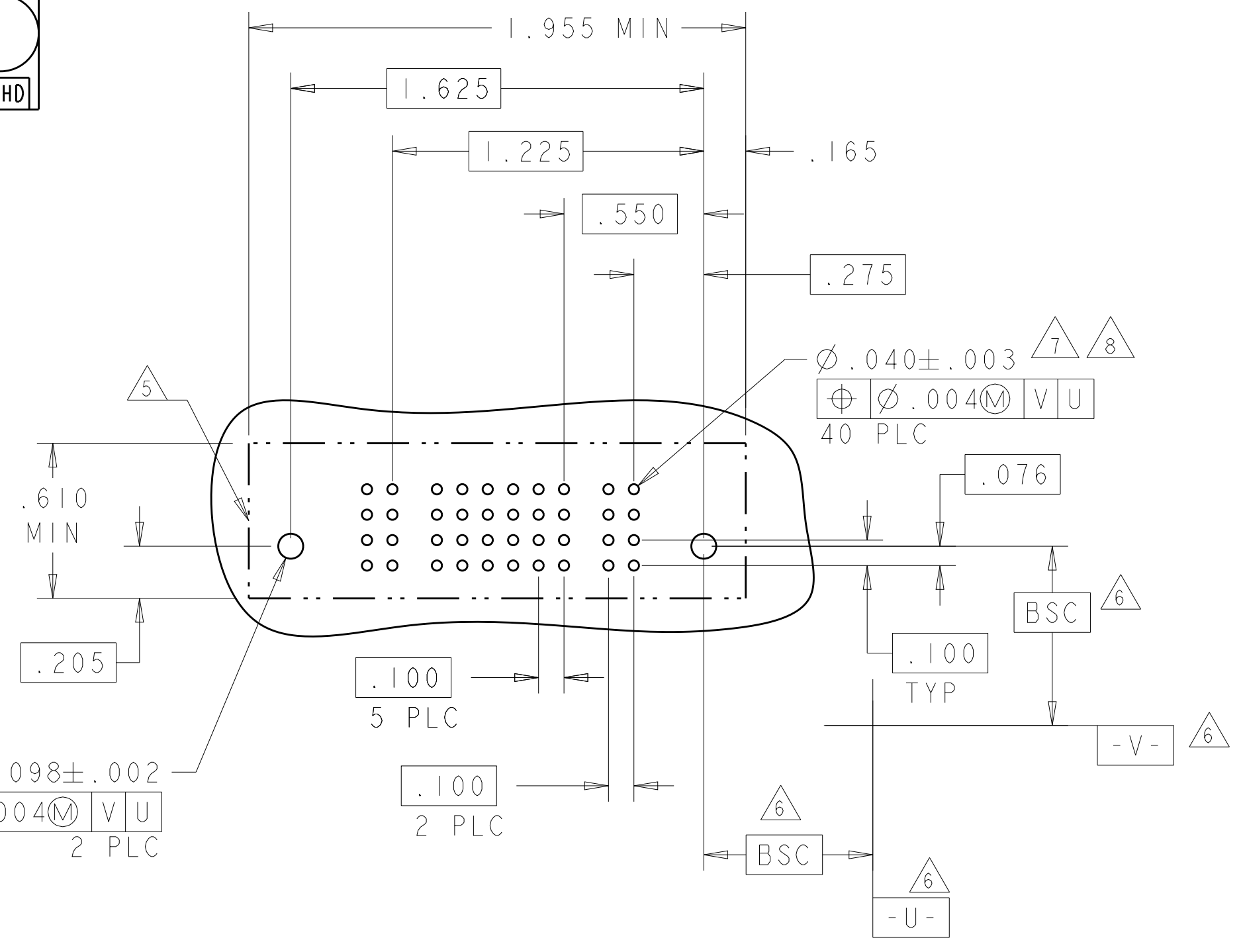

| PART NUMBER | ROWS | POWER | | | | | SIGNAL | | | | | POWER | | | | | | | | |
|-------------|------------------|-------|-----|-----|-----|----|--------|----|----|----|----|-------|----|----|----|----|----|----|----|----|
| | | P13 | P12 | P11 | P10 | P9 | P8 | 6 | 5 | 4 | 3 | 2 | 1 | P7 | P6 | P5 | P4 | P3 | P2 | P1 |
| 6450140-8 | D C B A | VA | VA | VA | VA | VA | VA | VA | VA | VA | VA | VA | VA | VA | VA | VA | VA | VA | VA | VA |
| | | VA | VA | VA | VA | VA | VA | VA | VA | VA | VA | VA | VA | VA | VA | VA | VA | VA | VA | VA |

7P + 24S + 6P

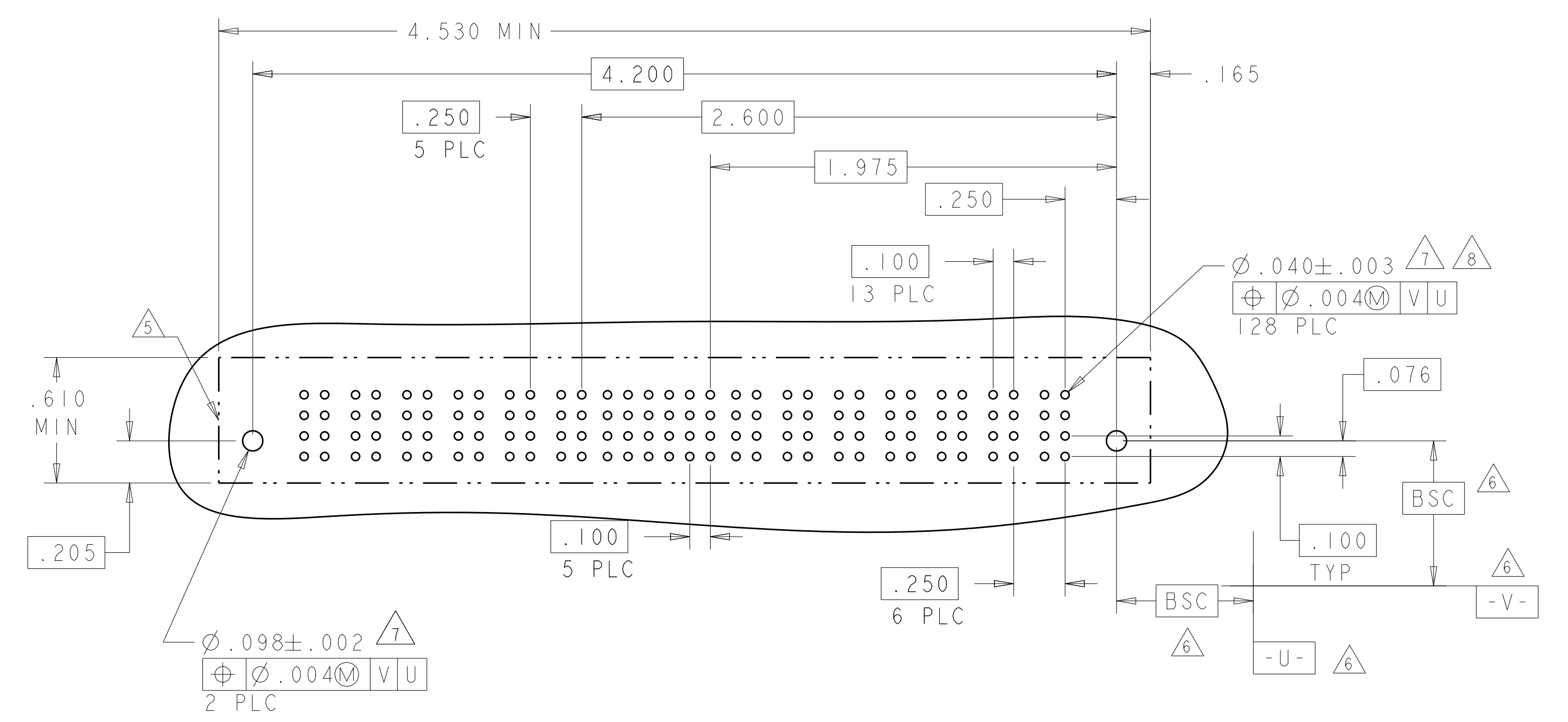

| PART NUMBER | ROWS | POWER | | | | | SIGNAL | | | | | | | | POWER | | | | | | | |
|-------------|------------------|-------|-----|-----|-----|----|--------|----|----|----|----|----|----|----|-------|----|----|----|----|----|----|----|
| | | P13 | P12 | P11 | P10 | 8 | 7 | 6 | 5 | 4 | 3 | 2 | 1 | P9 | P8 | P7 | P6 | P5 | P4 | P3 | P2 | P1 |
| 6450140-7 | D C B A | VA | VA | VA | VA | VA | VA | VA | VA | VA | VA | VA | VA | VA | VA | VA | VA | VA | VA | VA | VA | VA |
| | | VA | VA | VA | VA | VA | VA | VA | VA | VA | VA | VA | VA | VA | VA | VA | VA | VA | VA | VA | VA | VA |

J2 + 36S + 4P

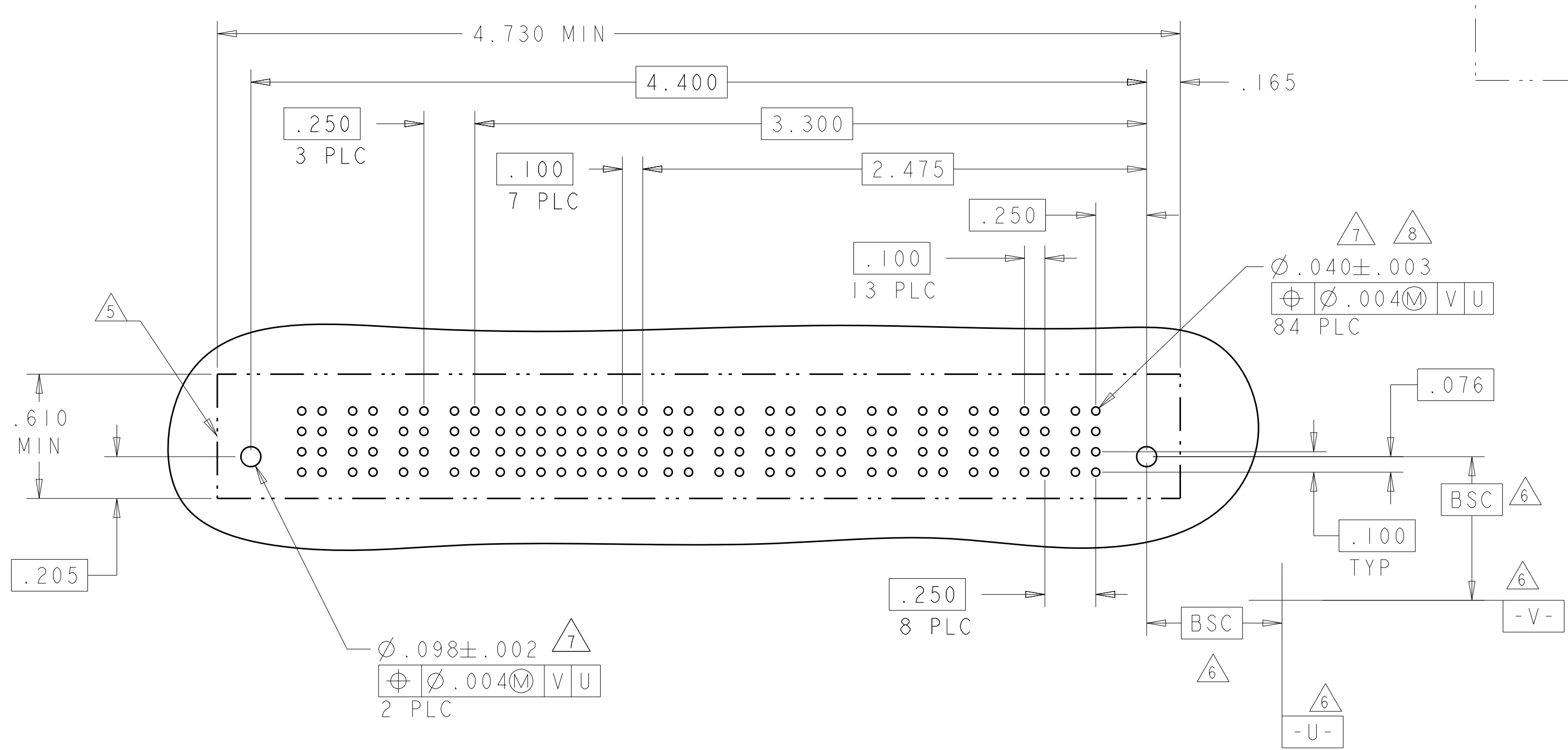

THIS DRAWING IS A CONTROLLED DOCUMENT. DWN: R. GRZYBOWSKI 15FEB05
 CHK: M. PERCHERKE 15FEB05
 APVD: M. PERCHERKE

TE Connectivity

VERTICAL RECEPTACLE ASSEMBLY WITH GUIDES MULTI-BEAM XL

SIZE: A1 CAGE CODE: 6450140 DRAWING NO: 114-13038
 WEIGHT: 108-1973 APPLICATION SPEC: 108-1973
 CUSTOMER DRAWING

SCALE: 2:1 SHEET 5 OF 11 REV: E4

| PART NUMBER | ROWS | POWER | | | | | | | | SIGNAL | | | | | | | | POWER | | | | | | | |
|---------------|------|-------|-----|-----|-----|-----|----|----|----|--------|---|---|---|---|---|----|----|-------|----|----|----|----|--|--|--|
| | | P14 | P13 | P12 | P11 | P10 | P9 | P8 | 7 | 6 | 5 | 4 | 3 | 2 | 1 | P7 | P6 | P5 | P4 | P3 | P2 | P1 | | | |
| I-6450140-3 | DCBA | VA | VA | VA | VA | VA | VA | VA | VA | E | E | E | E | E | E | VA | VA | VA | VA | VA | VA | VA | | | |
| | | VA | VA | VA | VA | VA | VA | VA | VA | E | E | E | E | E | E | VA | VA | VA | VA | VA | VA | VA | | | |
| | | VA | VA | VA | VA | VA | VA | VA | VA | E | E | E | E | E | E | VA | VA | VA | VA | VA | VA | VA | | | |
| | | VA | VA | VA | VA | VA | VA | VA | VA | E | E | E | E | E | E | VA | VA | VA | VA | VA | VA | VA | | | |
| 7P + 28S + 7P | | | | | | | | | | | | | | | | | | | | | | | | | |

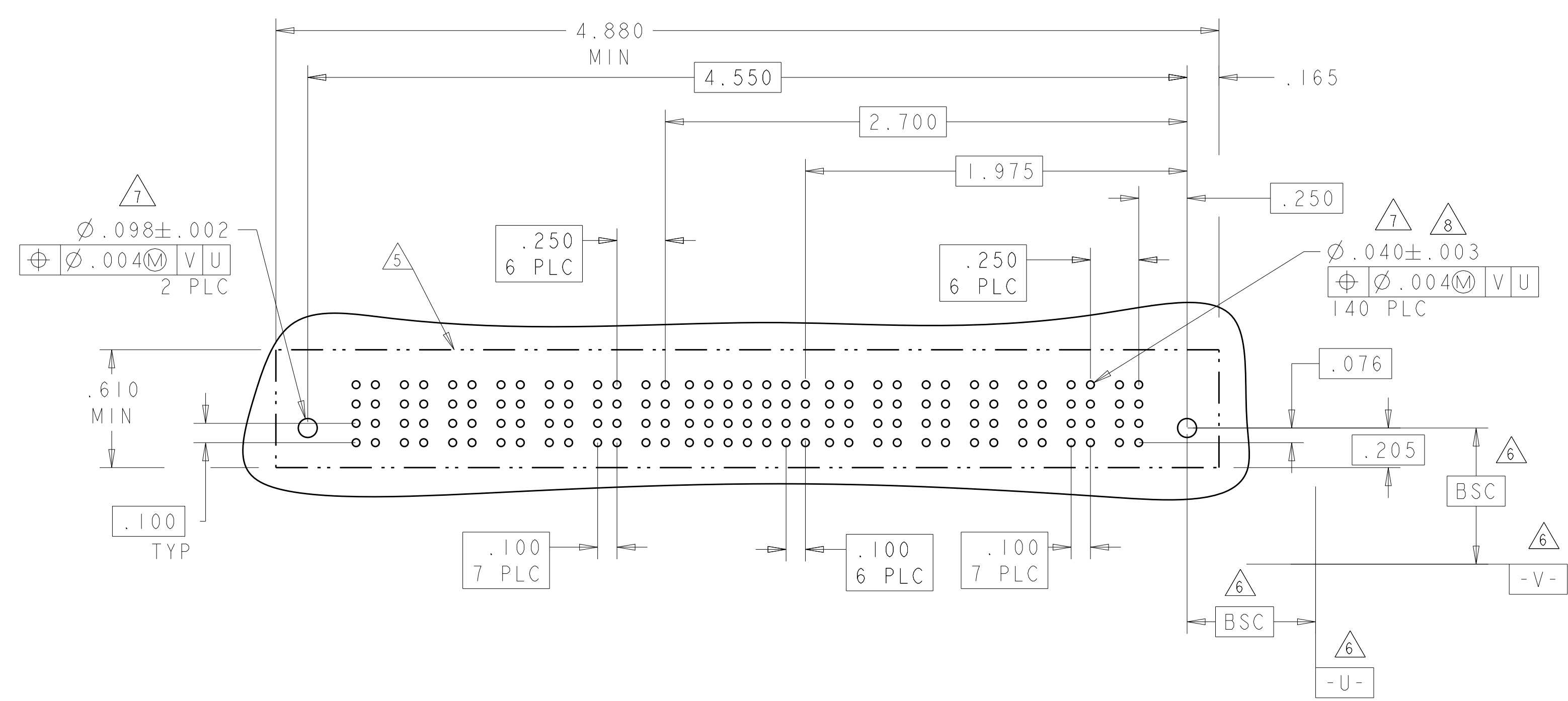

| PART NUMBER | ROWS | POWER | | | | | SIGNAL | | | | | POWER | | | | |
|-------------------|------|-------|----|----|----|----|--------|---|---|---|---|-------|----|----|----|--|
| | | P8 | P7 | P6 | P5 | 6 | 5 | 4 | 3 | 2 | 1 | P4 | P3 | P2 | P1 | |
| I-6450140-9 | DCBA | VA | VA | VA | VA | VA | E | E | E | E | E | VA | VA | VA | VA | |
| | | VA | VA | VA | VA | VA | E | E | E | E | E | VA | VA | VA | VA | |
| | | VA | VA | VA | VA | VA | E | E | E | E | E | VA | VA | VA | VA | |
| | | VA | VA | VA | VA | VA | E | E | E | E | E | VA | VA | VA | VA | |
| 4HDP + 24S + 4HDP | | | | | | | | | | | | | | | | |

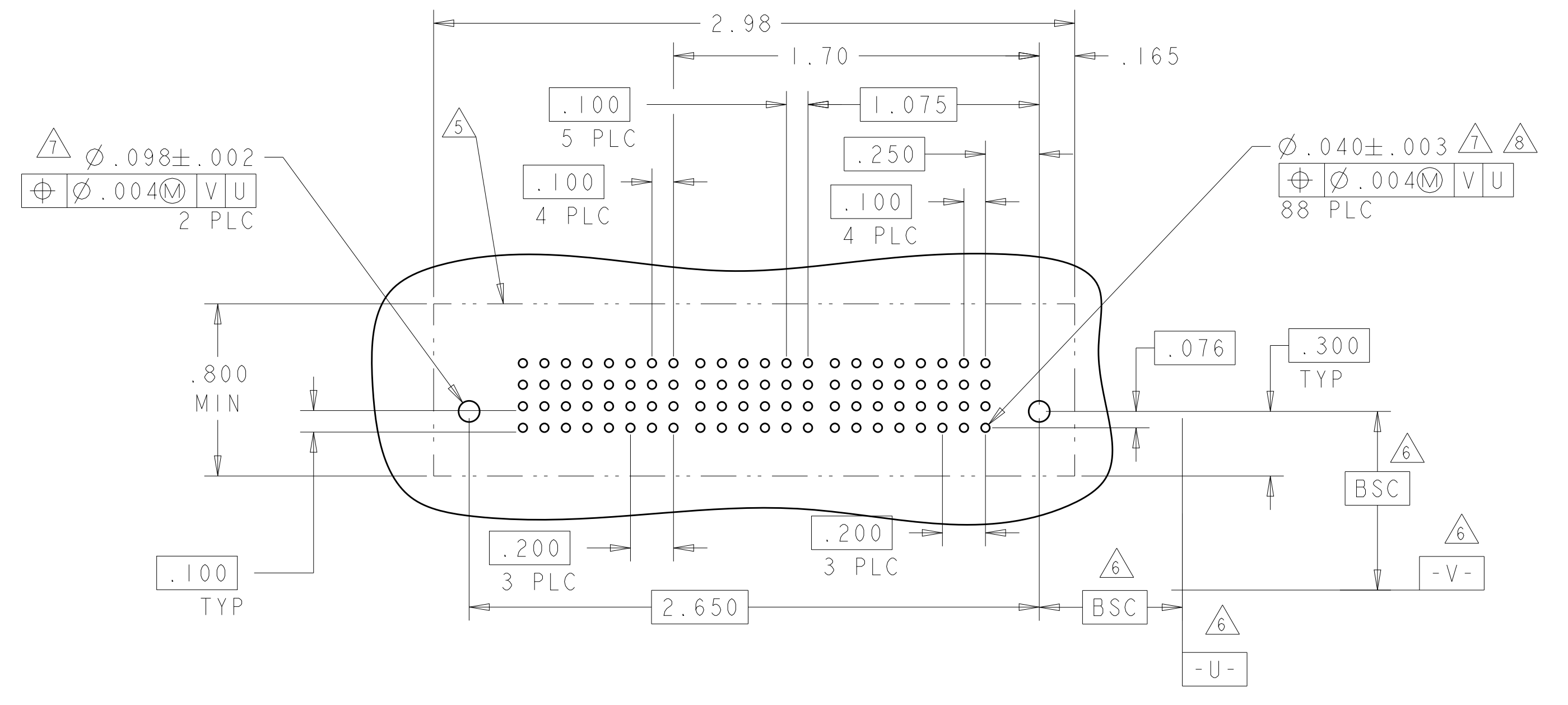

| PART NUMBER | ROWS | POWER | | | | SIGNAL | | | | POWER | | | |
|---------------|------|-------|----|---|---|--------|---|----|----|-------|----|----|----|
| | | P4 | P3 | 4 | 3 | 2 | 1 | P2 | P1 | P2 | P1 | P2 | P1 |
| I-6450140-8 | DCBA | VA | VA | E | E | E | E | VA | VA | VA | VA | VA | VA |
| | | VA | VA | E | E | E | E | VA | VA | VA | VA | VA | VA |
| | | VA | VA | E | E | E | E | VA | VA | VA | VA | VA | VA |
| | | VA | VA | E | E | E | E | VA | VA | VA | VA | VA | VA |
| 2P + 16S + 2P | | | | | | | | | | | | | |

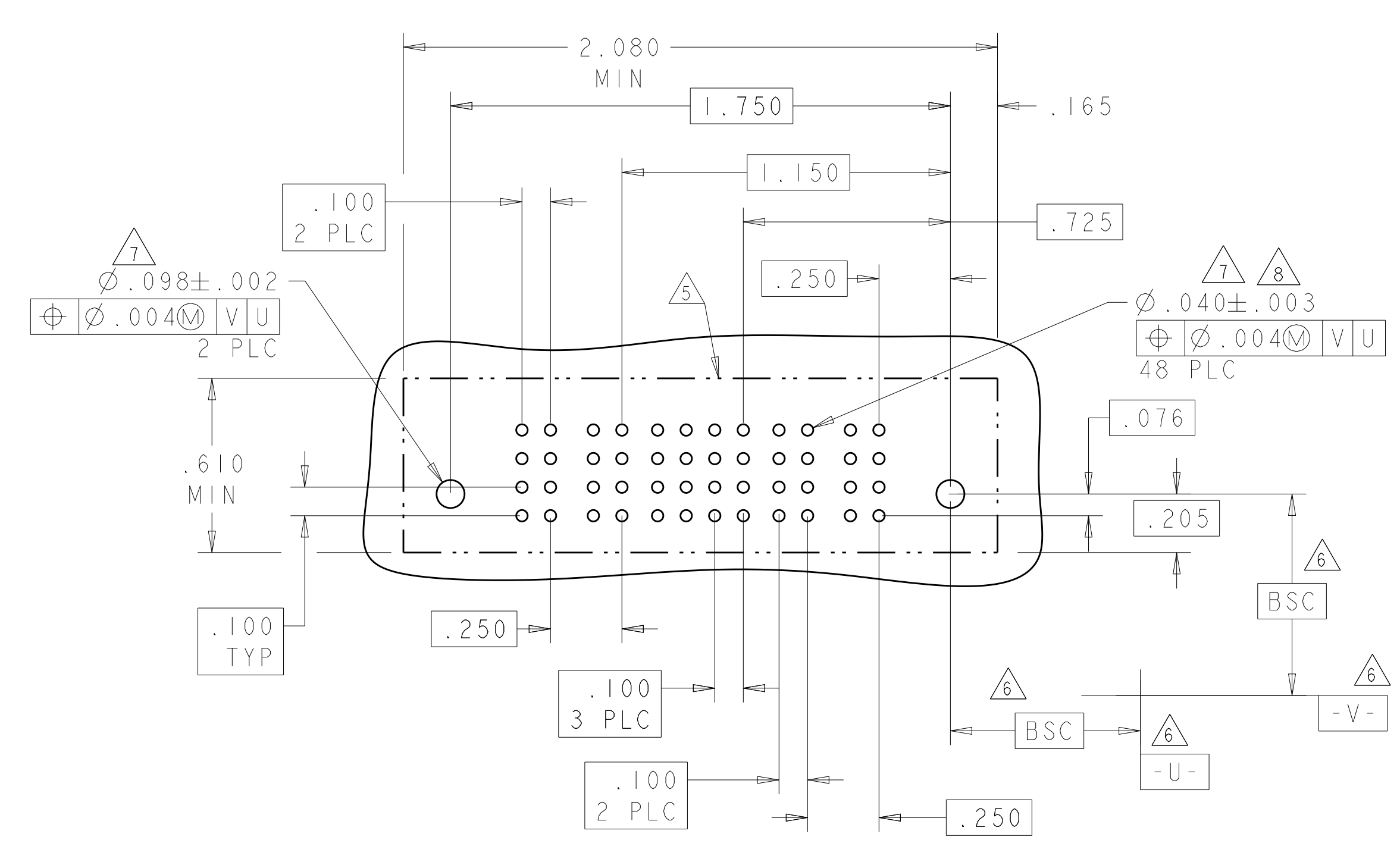

| PART NUMBER | ROWS | POWER | | | | | SIGNAL | | | | | POWER | | | | |
|---------------|------|-------|----|---|---|---|--------|---|---|----|----|-------|----|----|----|--|
| | | P4 | P3 | 6 | 5 | 4 | 3 | 2 | 1 | P2 | P1 | P2 | P1 | P2 | P1 | |
| 2-6450140-0 | DCBA | VA | VA | E | E | E | E | E | E | VA | VA | VA | VA | VA | VA | |
| | | VA | VA | E | E | E | E | E | E | VA | VA | VA | VA | VA | VA | |
| | | VA | VA | E | E | E | E | E | E | VA | VA | VA | VA | VA | VA | |
| | | VA | VA | E | E | E | E | E | E | VA | VA | VA | VA | VA | VA | |
| 2P + 24S + 2P | | | | | | | | | | | | | | | | |

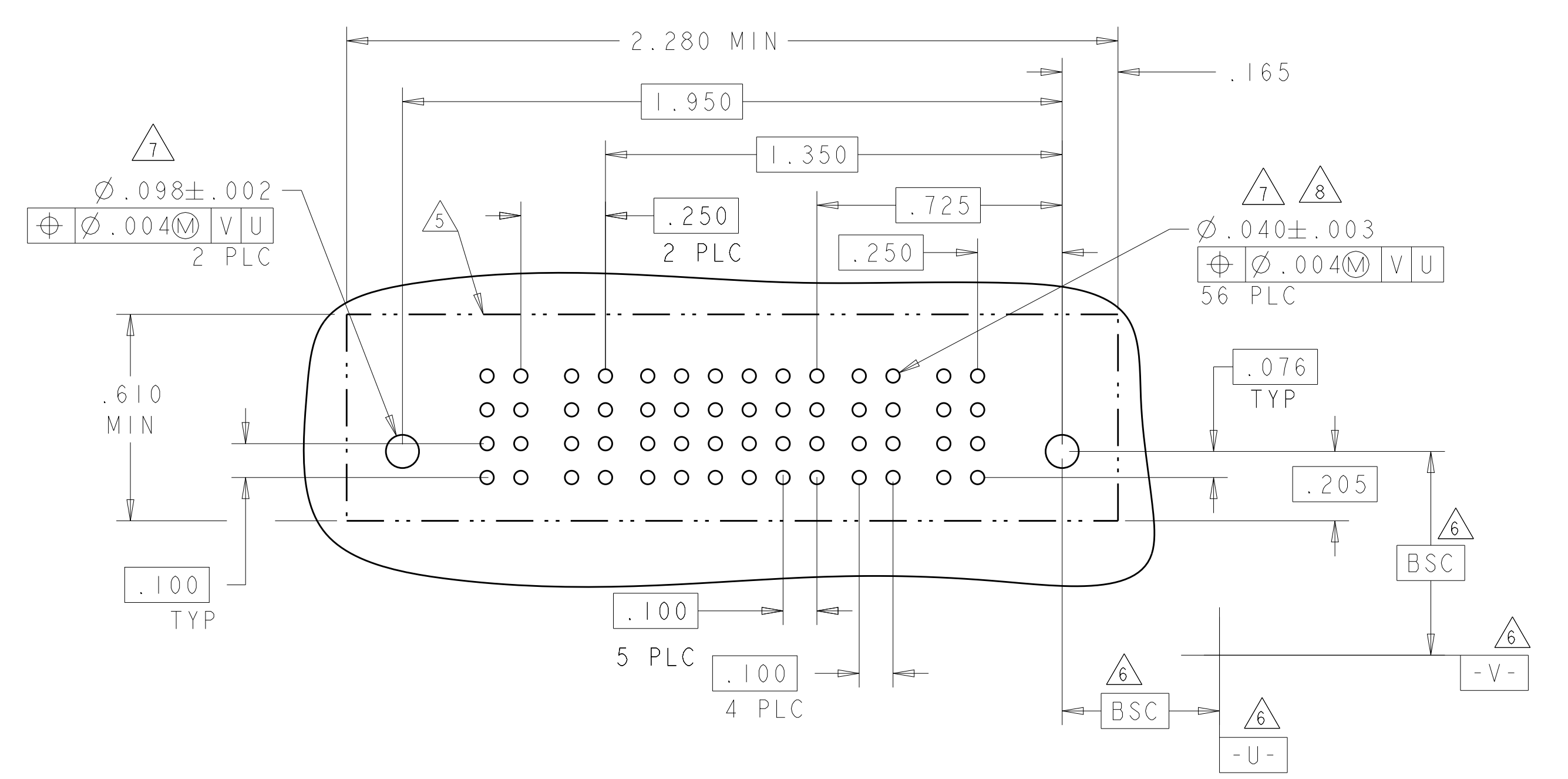

THIS DRAWING IS A CONTROLLED DOCUMENT.

OWN: R. GRZYBOWSKI 15FEB05
 CHK: M. PERCHERKE 15FEB05
 APVD: M. PERCHERKE

DIMENSIONS: INCHES
 TOLERANCES UNLESS OTHERWISE SPECIFIED:
 0 PLC ±.01
 1 PLC ±.01
 2 PLC ±.01
 3 PLC ±.005
 4 PLC ±.002
 ANGLES ±.020

MATERIAL: FINISH:

PRODUCT SPEC: 108-1973
 APPLICATION SPEC: 114-13038
 WEIGHT: A100779
 CUSTOMER DRAWING

NAME: VERTICAL RECEPTACLE ASSEMBLY WITH GUIDES MULTI-BEAM XL
 SIZE: CAGE CODE: DRAWING NO: 6450140
 SCALE: 2:1 SHEET 7 OF 11 REV: E4

STE TE Connectivity

| LOC | DIST | REV | DATE | BY | APPV |
|-----|------|-----|------|----|------|
| ES | 00 | | | | |

| PART NUMBER | ROWS | POWER | | | SIGNAL | | | | | | POWER | | |
|---------------|------------------|-------|----|----|--------|---|---|---|---|---|-------|----|----|
| | | P6 | P5 | P4 | 6 | 5 | 4 | 3 | 2 | 1 | P3 | P2 | P1 |
| 2-6450140-5 | D C B A | VM | VM | VA | E | E | E | E | E | E | E | VM | VM |
| 3P + 24S + 3P | | | | | | | | | | | | | |

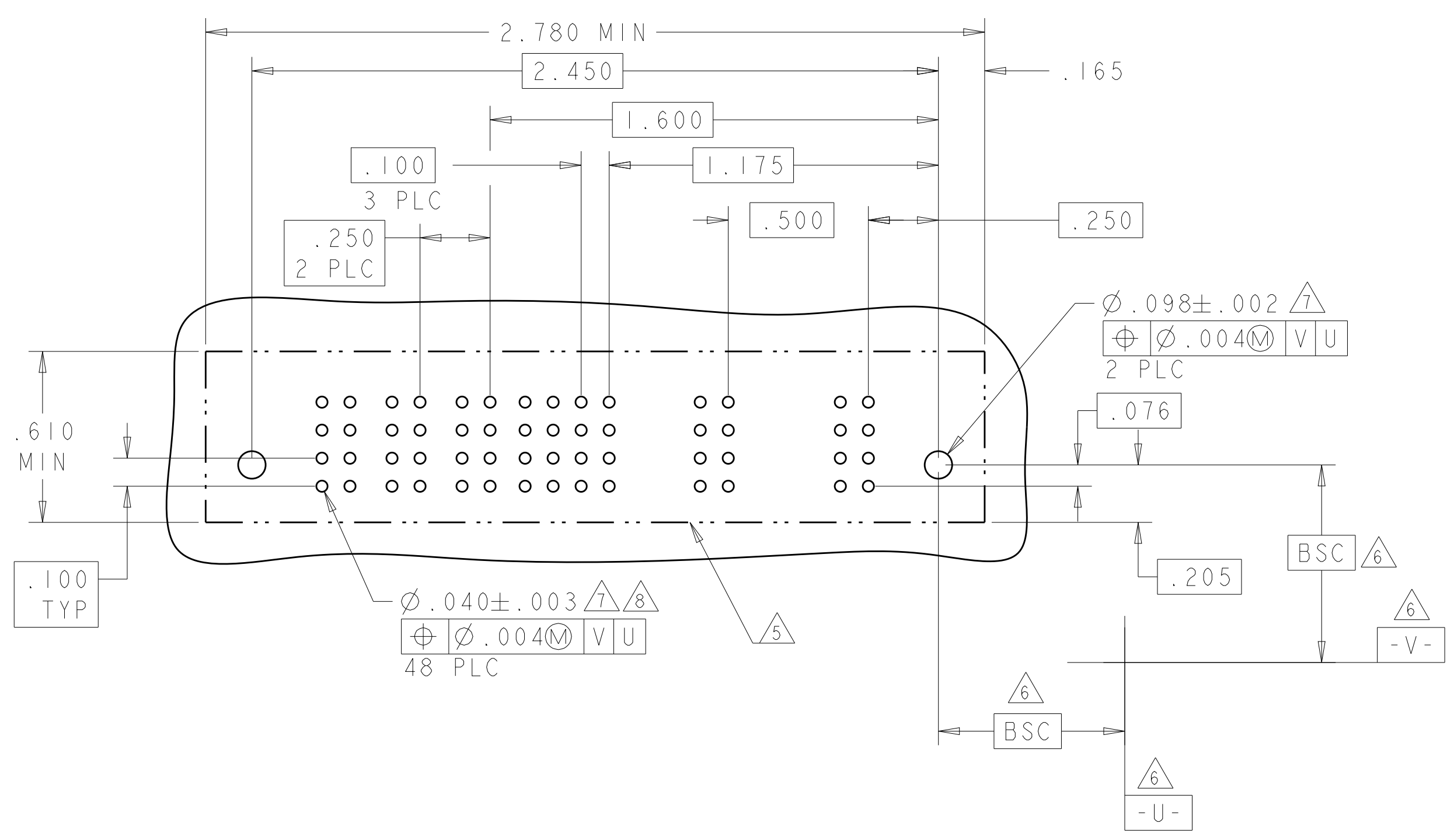

| PART NUMBER | ROWS | POWER | | SIGNAL | | | | | | POWER | | | | | |
|---------------|------------------|-------|----|--------|---|---|---|---|---|-------|----|----|----|----|----|
| | | P6 | P5 | 6 | 5 | 4 | 3 | 2 | 1 | P4 | P3 | P2 | P1 | | |
| 2-6450140-7 | D C B A | VM | VM | E | E | E | E | E | E | E | E | VM | VM | VM | VM |
| 4P + 24S + 2P | | | | | | | | | | | | | | | |

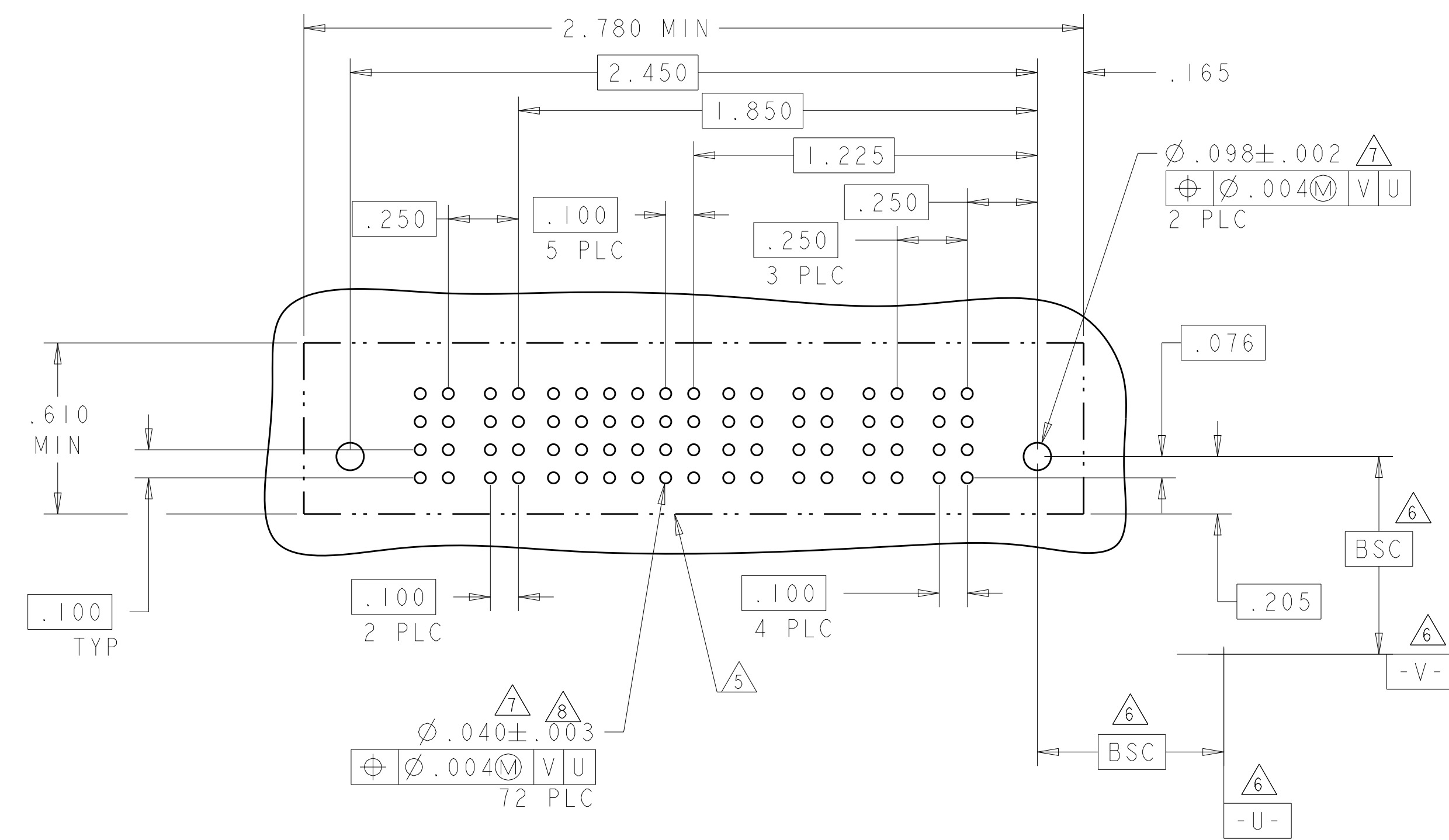

| PART NUMBER | ROWS | POWER | | | | SIGNAL | | | | | | POWER | | | | | | | | | | | | | |
|-----------------|------------------|-------|-----|-----|----|--------|---|---|---|---|---|-------|----|----|----|----|----|----|----|----|----|----|----|----|----|
| | | P12 | P11 | P10 | P9 | 6 | 5 | 4 | 3 | 2 | 1 | P8 | P7 | P6 | P5 | P4 | P3 | P2 | P1 | | | | | | |
| 2-6450140-6 | D C B A | VM | VM | VM | VM | E | E | E | E | E | E | E | E | E | E | E | E | VM | VM | VM | VM | VM | VM | VM | VM |
| 8P + 24S + 4ACP | | | | | | | | | | | | | | | | | | | | | | | | | |

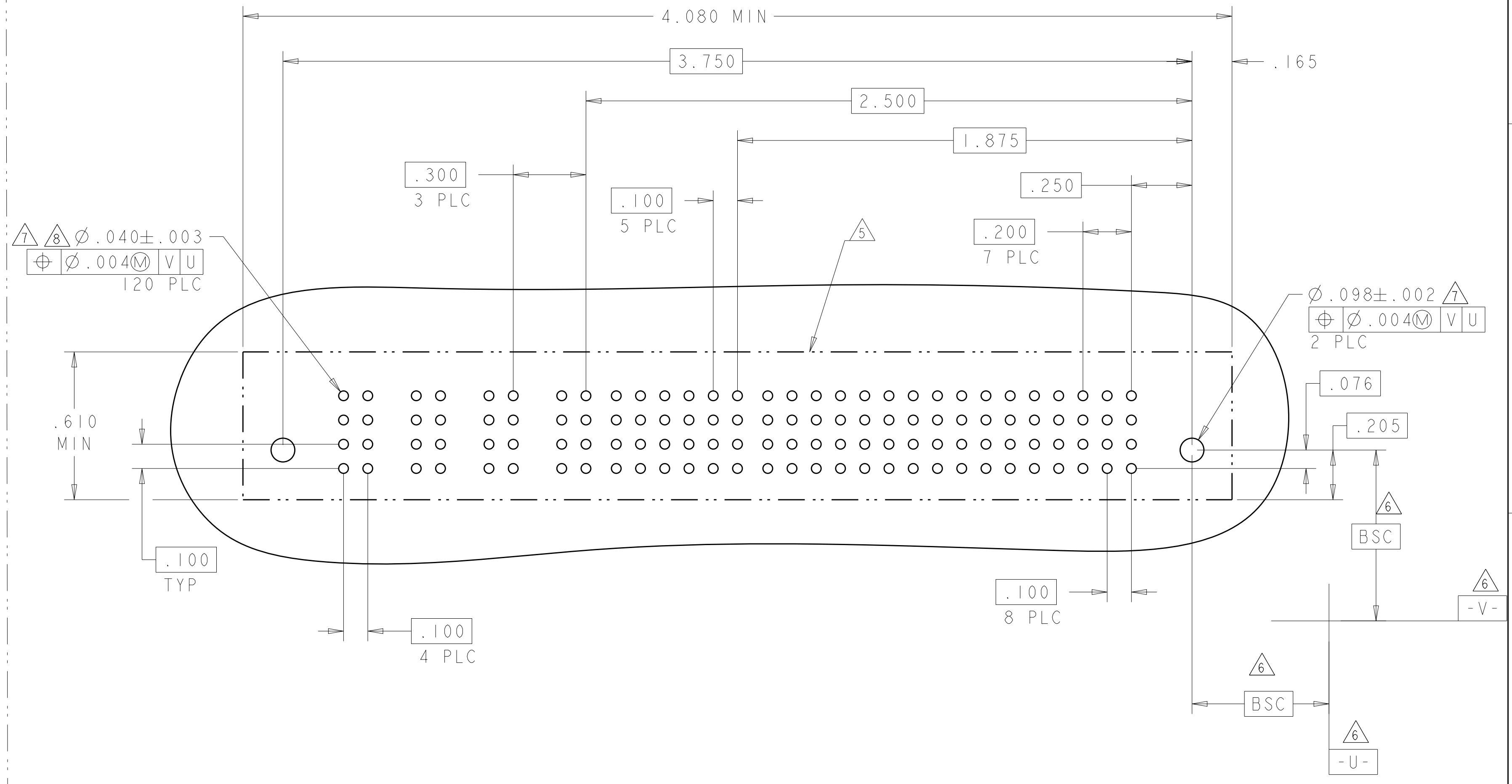

| | | | |
|---|--|-----------------------------|--|
| THIS DRAWING IS A CONTROLLED DOCUMENT. | | OWN: R. GRZYBOWSKI 15FEB05 | TE Connectivity |
| DIMENSIONS: INCHES | | CHK: M. PERCHERKE 15FEB05 | |
| TOLERANCES UNLESS OTHERWISE SPECIFIED: | | APVD: M. PERCHERKE | NAME: VERTICAL RECEPTACLE ASSEMBLY WITH GUIDES MULTI-BEAM XL |
| 0 PLC ±.01 1 PLC ±.01 2 PLC ±.01 3 PLC ±.005 4 PLC ±.0020 ANGLES ±.020 | | PRODUCT SPEC: 108-1973 | SIZE: CAGE CODE DRAWING NO: A100779C=6450140 |
| MATERIAL: FINISH: | | APPLICATION SPEC: 114-13038 | RESTRICTED TO: - |
| CUSTOMER DRAWING | | WEIGHT: - | SCALE: 2:1 SHEET 8 OF 11 REV: E4 |

| LOC | DIST | REVISIONS | | | |
|-----|------|-------------|------|-----|------|
| P | LTN | DESCRIPTION | DATE | DMN | APVD |
| ES | 00 | SEE SHEET 1 | | | |

| PART NUMBER | ROWS | POWER | | | | SIGNAL | | | | | | POWER | | | | | |
|---------------|------|-------|----|----|----|--------|---|---|---|---|---|-------|----|----|----|---|----|
| | | P8 | P7 | P6 | P5 | 6 | 5 | 4 | 3 | 2 | 1 | P4 | P3 | P2 | P1 | | |
| 2-6450140-8 | DCBA | VM | VM | VM | VM | E | E | E | E | E | E | E | E | E | E | E | E |
| | | VM | VM | VM | VM | E | E | E | E | E | E | E | E | E | E | E | E |
| | | VM | VM | VM | VM | E | E | E | E | E | E | E | E | E | E | E | E |
| | | VM | VM | VM | VM | E | E | E | E | E | E | E | E | E | E | E | E |
| 4P + 24S + 4P | | HD | | | | | | | | | | | | | | | HD |

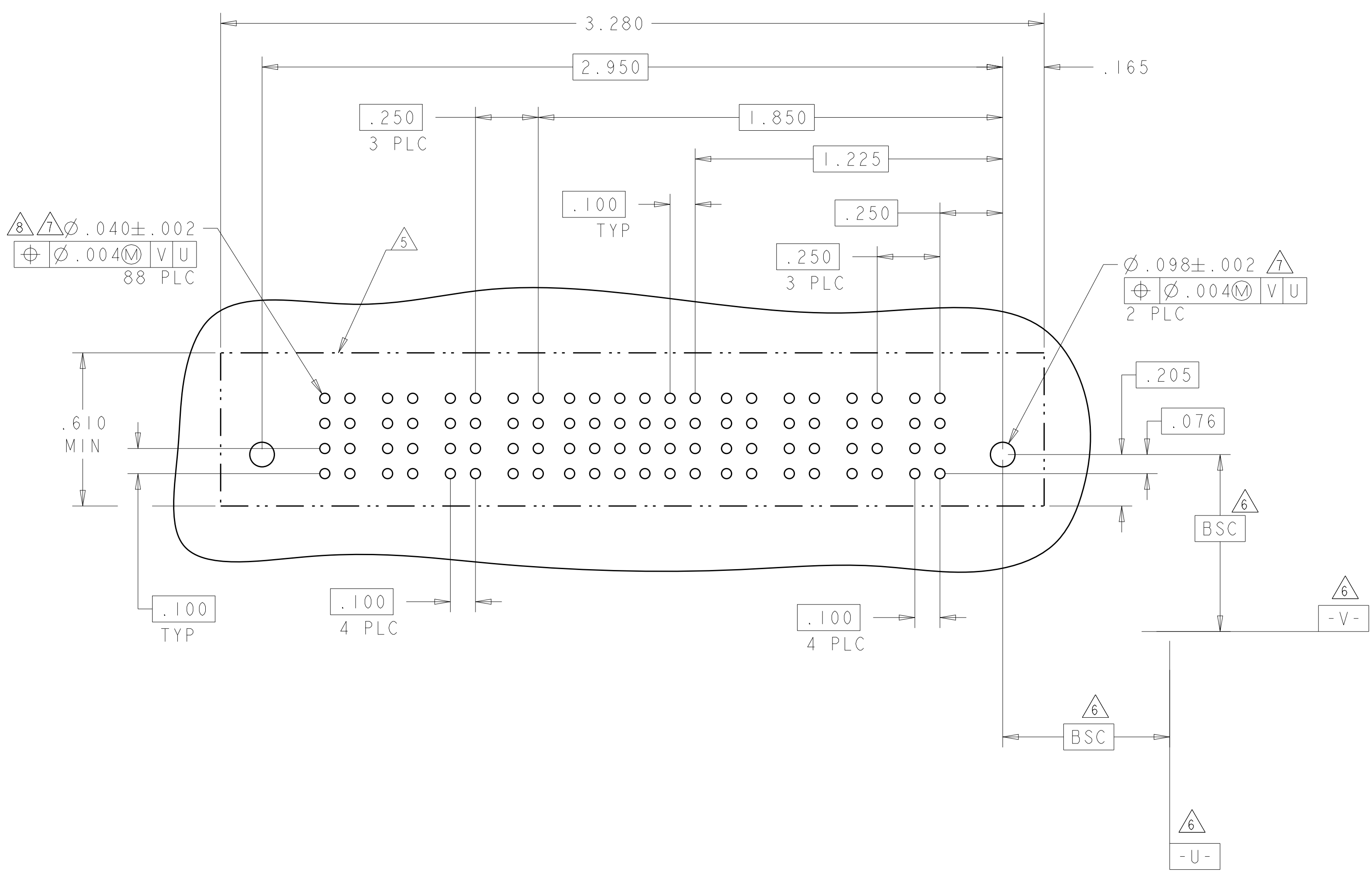

| PART NUMBER | ROWS | POWER | | SIGNAL | | | | | | POWER | | | |
|---------------|------|-------|----|--------|---|---|---|---|---|-------|----|---|----|
| | | P2 | P1 | 6 | 5 | 4 | 3 | 2 | 1 | P4 | P3 | | |
| 3-6450140-5 | DCBA | VA | VA | E | E | E | E | E | E | E | E | E | E |
| | | VA | VA | E | E | E | E | E | E | E | E | E | E |
| | | VA | VA | E | E | E | E | E | E | E | E | E | E |
| | | VA | VA | E | E | E | E | E | E | E | E | E | E |
| IP + 24S + IP | | HD | | | | | | | | | | | HD |

| PART NUMBER | ROWS | POWER | | SIGNAL | | | | | | POWER | | | |
|---------------|------|-------|----|--------|---|---|---|---|---|-------|----|---|----|
| | | P2 | P1 | 6 | 5 | 4 | 3 | 2 | 1 | P4 | P3 | | |
| 3-6450140-6 | DCBA | VA | VA | E | E | E | E | E | E | E | E | E | E |
| | | VA | VA | E | E | E | E | E | E | E | E | E | E |
| | | VA | VA | E | E | E | E | E | E | E | E | E | E |
| | | VA | VA | E | E | E | E | E | E | E | E | E | E |
| IP + 24S + IP | | HD | | | | | | | | | | | HD |

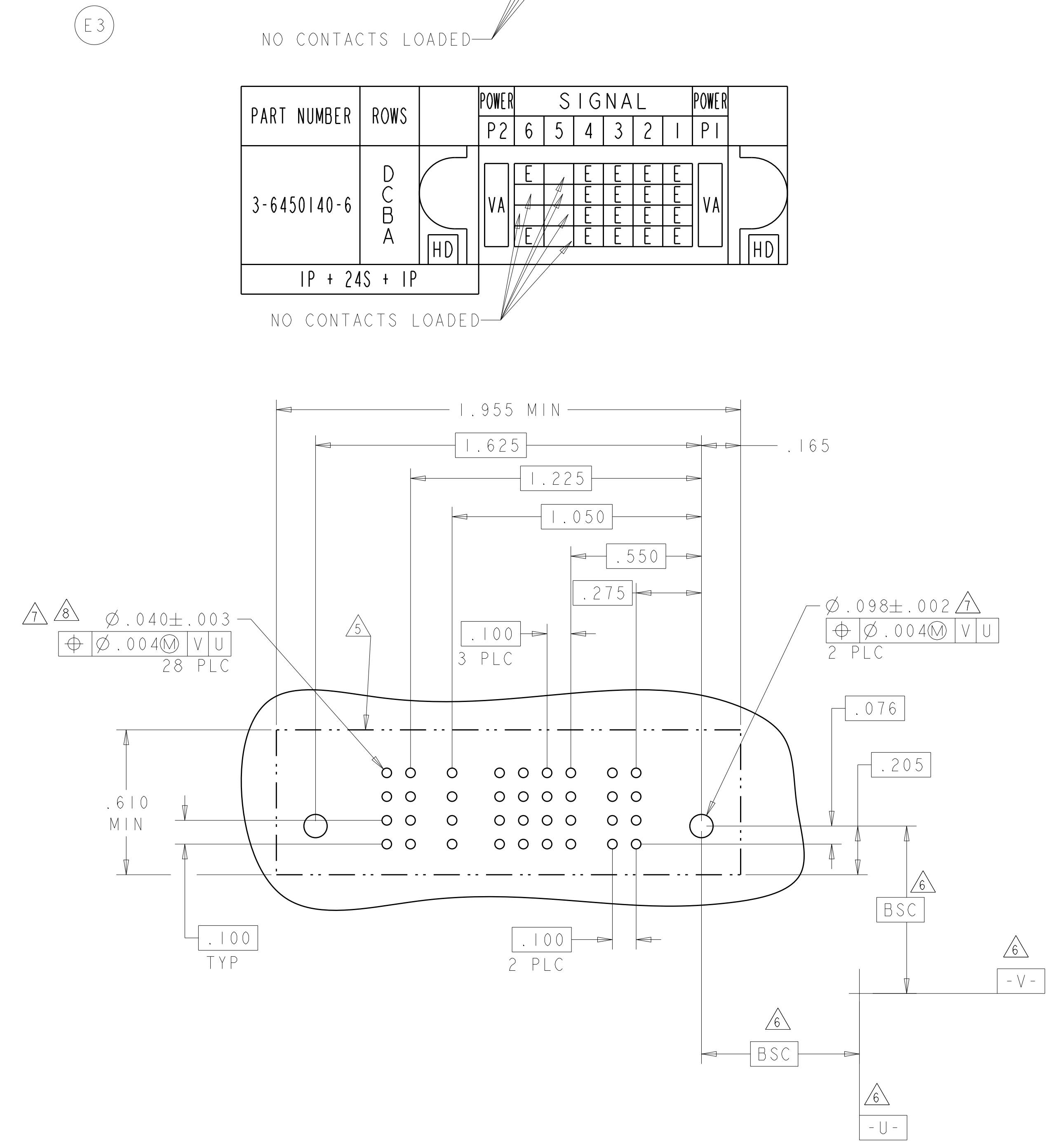

THIS DRAWING IS A CONTROLLED DOCUMENT.

| | | | |
|-----------------------|--|-----------------------------|--|
| DIMENSIONS: INCHES | TOLERANCES UNLESS OTHERWISE SPECIFIED: 0 PLC ±. 1 PLC ±.01 2 PLC ±.01 3 PLC ±.005 4 PLC ±.002 ANGLES ±.020 | DMN: R. GRZYBOWSKI 15FEB05 | NAME: VERTICAL RECEPTACLE ASSEMBLY WITH GUIDES MULTI-BEAM XL |
| | | CHK: M. PERCHERKE | |
| MATERIAL: - | | APVD: M. PERCHERKE | RESTRICTED TO: - |
| FINISH: - | | PRODUCT SPEC: 108-1973 | SIZE: A1 |
| | | APPLICATION SPEC: 114-13038 | CAGE CODE: 6450140 |
| | | WEIGHT: - | SCALE: 2:1 |
| | | CUSTOMER DRAWING | SHEET 9 OF 11 |

4805 (3/11)

| LOC | | DIST | | REVISIONS | | | |
|-----|----|------|-----|-------------|------|-----|------|
| ES | 00 | P | LTN | DESCRIPTION | DATE | DMN | APVD |
| | | - | | SEE SHEET 1 | | | |

| PART NUMBER | ROWS | SIGNAL | | | | | | | | | | | | P4 | P3 | P2 | P1 | | | | | |
|---------------|------|--------|----|----|----|---|---|---|---|---|---|---|---|----|----|----|----|----|----|----|----|---|
| | | P8 | P7 | P6 | P5 | 9 | 8 | 7 | 6 | 5 | 4 | 3 | 2 | | | | | 1 | | | | |
| 3-6450140-1 | D | VM | VM | VM | VM | E | E | E | E | E | E | E | E | E | E | E | E | VM | VM | VM | VM | |
| | C | | | | | E | E | E | E | E | E | E | E | E | E | E | E | | | | | |
| | B | | | | | E | E | E | E | E | E | E | E | E | E | E | E | | | | | E |
| | A | | | | | E | E | E | E | E | E | E | E | E | E | E | E | | | | | E |
| 4P + 36S + 4P | | HD | | | | | | | | | | | | | | | | | | | | |

| PART NUMBER | ROWS | POWER | | | SIGNAL | | | | | | | | POWER | | | | | | | |
|---------------|------|-------|----|----|--------|---|---|---|---|---|---|---|-------|----|----|----|---|---|---|---|
| | | P6 | P5 | P4 | 9 | 8 | 7 | 6 | 5 | 4 | 3 | 2 | 1 | P3 | P2 | P1 | | | | |
| 3-6450140-4 | DCBA | VM | VM | VM | E | E | E | E | E | E | E | E | E | E | E | E | E | E | | |
| | | | | | E | E | E | E | E | E | E | E | E | E | E | E | E | E | E | |
| | | | | | E | E | E | E | E | E | E | E | E | E | E | E | E | E | E | E |
| | | | | | E | E | E | E | E | E | E | E | E | E | E | E | E | E | E | E |
| 3P + 36S + 3P | | HD | | | | | | | | | | | | | | | | | | |

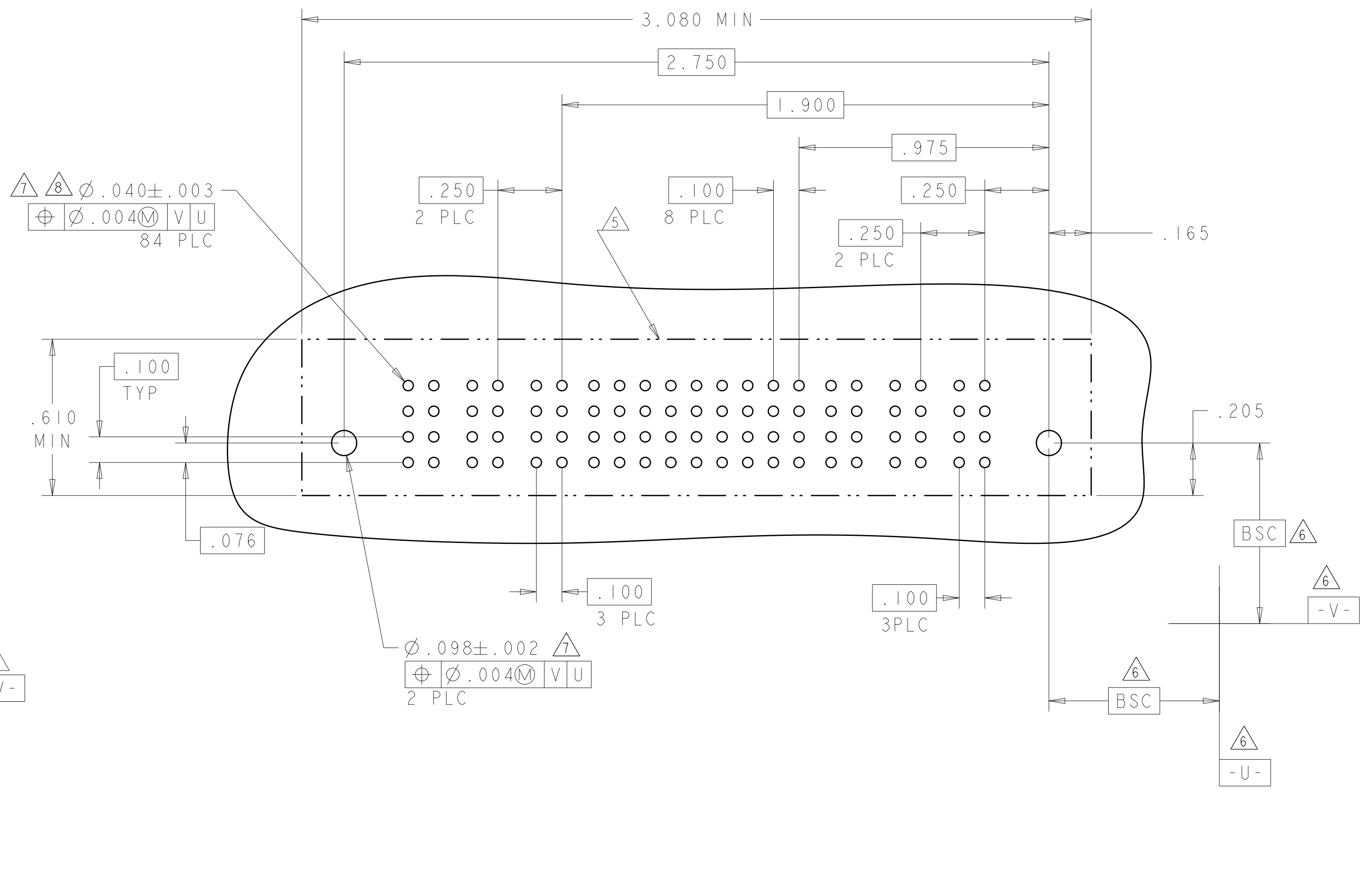
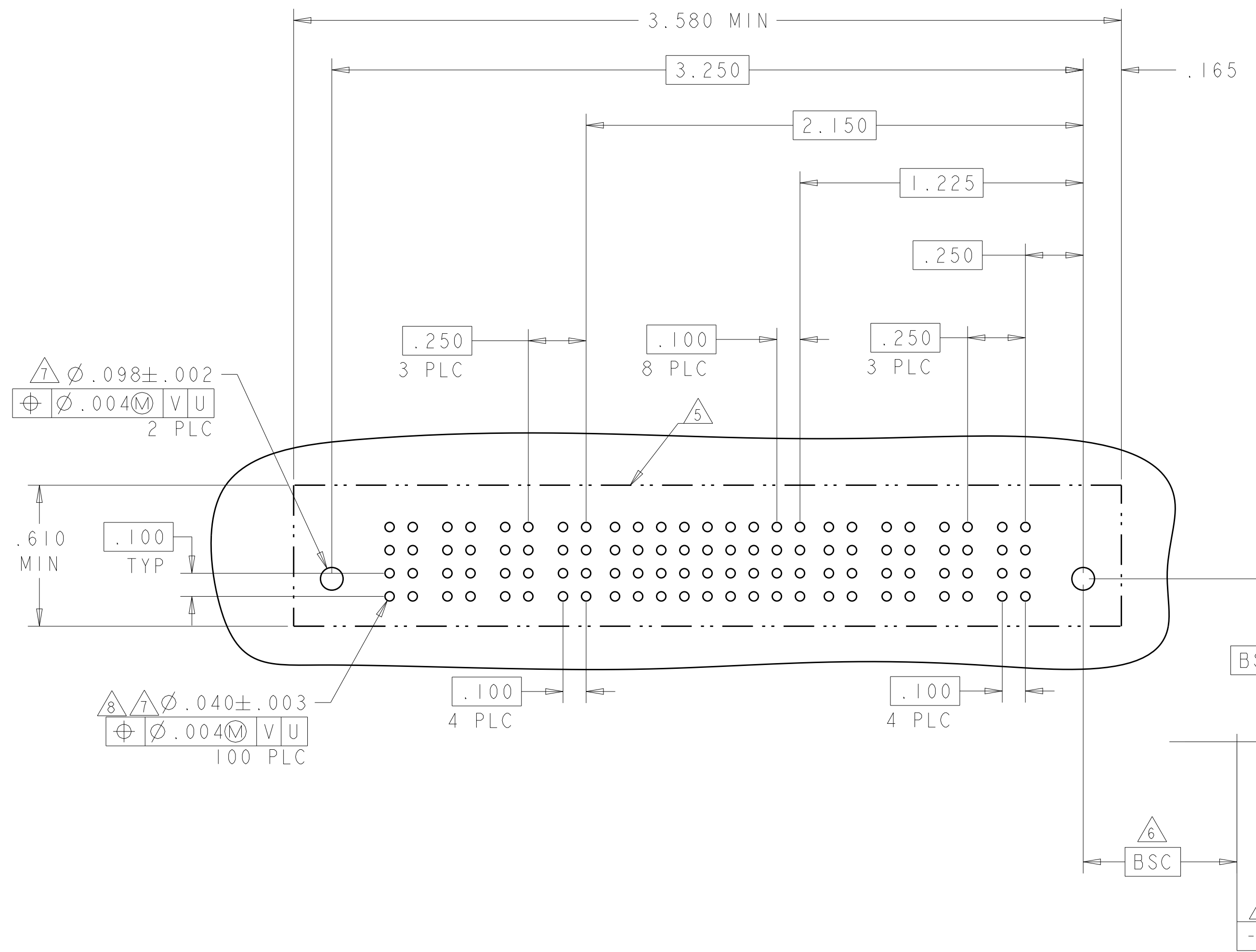

| | | | |
|--|--|-----------------------------|--|
| THIS DRAWING IS A CONTROLLED DOCUMENT. | | DMN: R. GRZYBOWSKI 15FEB05 | TE Connectivity |
| DIMENSIONS: INCHES | | CHK: M. PERCHERKE 15FEB05 | |
| TOLERANCES UNLESS OTHERWISE SPECIFIED: | | APVD: M. PERCHERKE | NAME: VERTICAL RECEPTACLE ASSEMBLY WITH GUIDES MULTI-BEAM XL |
| 0 PLC ± .01 1 PLC ± .01 2 PLC ± .01 3 PLC ± .005 4 PLC ± .002 ANGLES ± .020 | | PRODUCT SPEC: 108-1973 | SIZE: A1 |
| MATERIAL: - | | APPLICATION SPEC: 114-13038 | CAGE CODE: 6450140 |
| FINISH: - | | WEIGHT: - | RESTRICTED TO: - |
| | | CUSTOMER DRAWING | SCALE: 2:1 SHEET 11 OF 11 REV: E4 |

Компания «Life Electronics» занимается поставками электронных компонентов импортного и отечественного производства от производителей и со складов крупных дистрибьюторов Европы, Америки и Азии.

С конца 2013 года компания активно расширяет линейку поставок компонентов по направлению коаксиальный кабель, кварцевые генераторы и конденсаторы (керамические, пленочные, электролитические), за счёт заключения дистрибьюторских договоров

Мы предлагаем:

- Конкурентоспособные цены и скидки постоянным клиентам.
- Специальные условия для постоянных клиентов.
- Подбор аналогов.
- Поставку компонентов в любых объемах, удовлетворяющих вашим потребностям.
- Приемлемые сроки поставки, возможна ускоренная поставка.
- Доставку товара в любую точку России и стран СНГ.
- Комплексную поставку.
- Работу по проектам и поставку образцов.
- Формирование склада под заказчика.
- Сертификаты соответствия на поставляемую продукцию (по желанию клиента).
- Тестирование поставляемой продукции.
- Поставку компонентов, требующих военную и космическую приемку.
- Входной контроль качества.
- Наличие сертификата ISO.

В составе нашей компании организован Конструкторский отдел, призванный помогать разработчикам, и инженерам.

Конструкторский отдел помогает осуществить:

- Регистрацию проекта у производителя компонентов.
- Техническую поддержку проекта.
- Защиту от снятия компонента с производства.
- Оценку стоимости проекта по компонентам.
- Изготовление тестовой платы монтаж и пусконаладочные работы.



Тел: +7 (812) 336 43 04 (многоканальный)

Email: org@lifeelectronics.ru