

## Bulk Metal® Foil Technology Ultra High Precision Trimming Potentiometers, 1/4" Square, RJ26 Style, Designed to Meet or Exceed The Requirements of MIL-PRF-39035, Char. H with a Smooth and Unidirectional Output

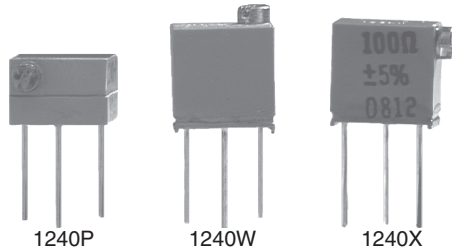

### INTRODUCTION

Vishay Foil precision trimmers have the Bulk Metal® Foil resistive element which possesses a unique inherent temperature and load life stability. Plus, their advanced virtually backlash-free adjustment mechanism makes them easy to set quickly and accurately and keeps the setting exactly on target.

### FEATURES

- Temperature coefficient of resistance (TCR):  $\pm 10$  ppm/°C. (- 55 °C to + 150 °C ref. at + 25 °C); through the wiper <sup>(3)</sup>;  $\pm 25$  ppm/°C (see table 2 for low values)
- A smooth and unidirectional resistance with leadscrew adjustment
- Load life stability: 0.1 % typical  $\Delta R$ , 1.0 % maximum  $\Delta R$  under full rated power at + 85 °C for 10 000 h
- Settability: 0.05 % typical; 0.1 % maximum
- Setting stability: 0.1 % typical; 0.5 % maximum, DSS
- Power rating: 0.25 W at + 85 °C
- Resistance range: 5  $\Omega$  to 10 k $\Omega$
- Tolerance:  $\pm 5$  %,  $\pm 10$  %
- Electrostatic discharge (ESD) up to 25 000 V
- Terminal finish: gold plated (tin/lead finish is available on request)



RoHS  
COMPLIANT

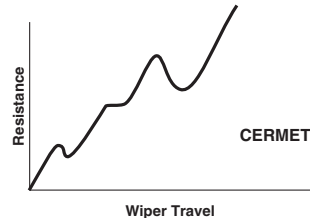
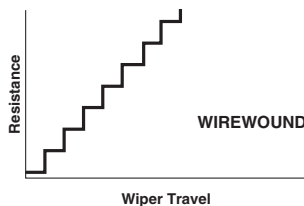
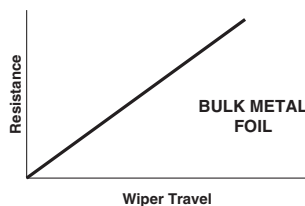

TABLE 1 - MODEL SELECTION				
MODEL	TERMINATION STYLE	AVERAGE WEIGHT (g)	POWER RATING at + 85 °C AMBIENT	NO. OF TURNS
1240	W-edge mount, top adjust	0.4	0.25 W	21 $\pm$ 2
	X-edge mount, side adjust			
	P-horizontal mount, side adjust			

#### Note

- See Figure 1, next page

TABLE 2 - 1240 (RJ26) SERIES ELECTRICAL SPECIFICATIONS	
Temperature Coefficient of Resistance (TCR) 50 $\Omega$ to 10 k $\Omega$ End-to-end <sup>(2)</sup>	$\pm 10$ ppm/°C maximum (- 55 °C to + 150 °C, + 25 °C ref.)
Temperature Coefficient of Resistance 5, 10 and 20 $\Omega$ Through the wiper <sup>(3)</sup>	$\pm 20$ ppm/°C $\pm 25$ ppm/°C
Stability Load life at 10 000 h End-to-end <sup>(2)</sup>	0.1 % typical $\Delta R$ 1.0 % maximum $\Delta R$ (under full rated power of 0.25 W at + 85 °C)
Power Rating <sup>(4)</sup>	0.25 W at + 85 °C
Settability	0.05 % typical; 0.1 % maximum
Setting Stability	0.1 % typical; 0.5 % maximum
Contact Resistance Variation - CRV (noise) <sup>(5)</sup>	3 $\Omega$ typical; 10 $\Omega$ maximum
Hop-off	0.25 % typical; 1.0 % maximum
High-Frequency Operation Rise time Inductance Capacitance	1.0 ns without ringing 0.08 $\mu$ H typical 0.5 pF typical
Operating Temperature Range	- 55 °C to + 150 °C

TABLE 3 - VALUES VS. TOLERANCES	
STANDARD RESISTANCE VALUES (in $\Omega$ )	STANDARD TOLERANCE
5, 10	$\pm 10$ %
20, 50, 100, 200, 500, 1K, 2K, 5K, 10K	$\pm 5$ %

TABLE 4 - MECHANICAL SPECIFICATIONS	
Adjustment Turns	21 $\pm$ 2
Mechanical Stops	Wiper idles - no discontinuity
Internal Terminations	All welded - no flux
Case Material	1240X - diallyl-phthalate: green (DAP) 1240W - diallyl-phthalate: green (DAP) 1240P - thermoplastic: black
Shaft Torque	3 oz. in. maximum
Backlash	0.005 % typical

**FIGURE 1 - SCHEMATIC AND DIMENSIONS** in Inches (Millimeters)

### 1240X

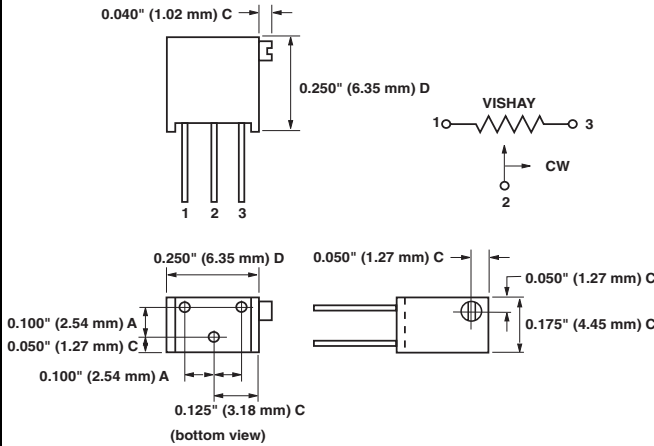

### 1240W

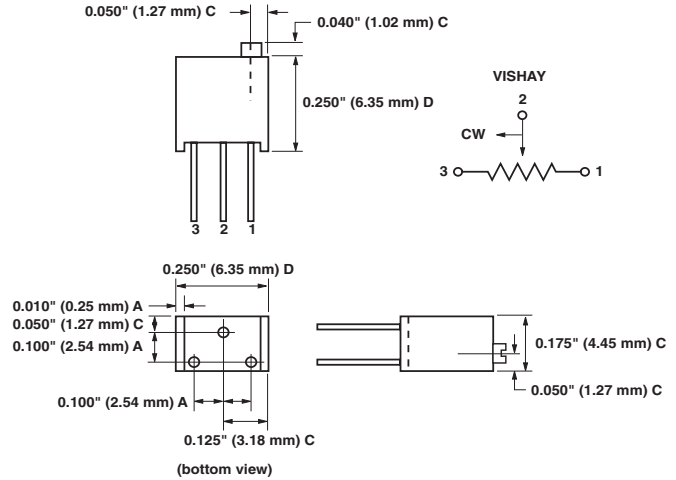

### 1240P

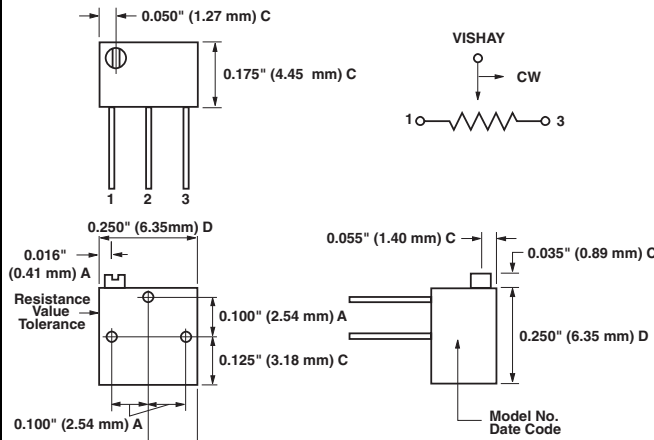

**TOLERANCES:**

- A = ± 0.005" (0.13 mm)
- C = ± 0.010" (0.25 mm)
- D = ± 0.020" (0.51 mm)

**STANDARD MARKING:**

- Model No.
- Date Code
- Resistance Value
- Tolerance

**NOTES:**

Adjustment screw 0.080" (2.03 mm) diameter with 0.025" (0.64 mm) X 0.030" (0.76 mm) slot. Tolerance on screw dimensions is ± 0.005" (0.13 mm). Model 1240 has gold plated terminal pins 0.016" (0.41 mm) ± 0.001" (0.03 mm) diameter, 0.200" (5.08 mm) length minimum.

**FIGURE 2 - POWER DERATING CURVE**

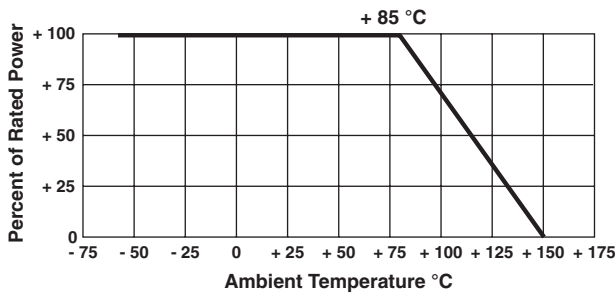

**FIGURE 3 - 1240W 10 kΩ LOAD LIFE, 20 UNITS, 10 000 h at 0.25 W, + 85 °C (Wiper at CW)**

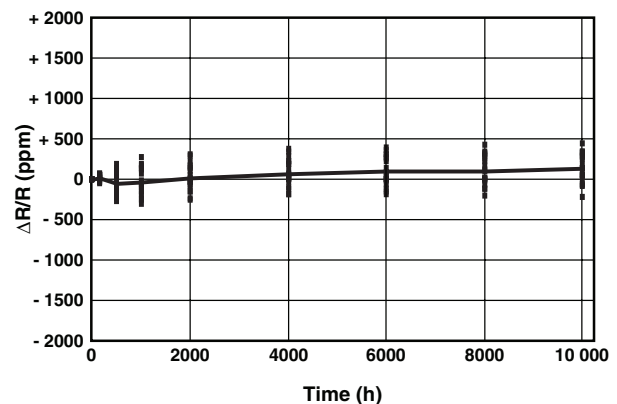

**TABLE 5 - COMPARISON**

	MIL-PRF-39035/3 CHARACTERISTIC H <sup>(6)</sup>	MODEL 1240 MAXIMUM
<b>TEST GROUP I</b> Conditioning Contact resistance variation - CRV (noise) Immersion	± 1.0 % ± 3.0 % or 3 Ω <sup>(7)</sup> No continuous stream of bubbles	± 0.5 % 3 Ω typical, 10 Ω maximum No continuous stream of bubbles
<b>TEST GROUP I a</b> Visual and mechanical Actual effective electrical travel End resistance  Dielectric withstanding voltage - DWV Per MIL-STD-202, methods 301 and 105 Atmospheric pressure Barometric pressure Insulation resistance Shaft torque Thermal shock Setting stability	No failures 10 to 25 turns 2 % or 2 Ω <sup>(7)</sup>  600 V <sub>AC</sub> , 1 min 250 V <sub>AC</sub> , 1 min ≥ 1000 MΩ 3 oz. in. maximum ± 1.0 % ± 1.0 %	No failures 21 ± 2 turns 2 Ω for values ≤ 1 kΩ; 5 Ω for values ≥ 2 kΩ;  600 V <sub>AC</sub> , 1 min 250 V <sub>AC</sub> , 1 min > 1000 MΩ 3 oz. in. maximum ± 0.5 % ± 0.5 %
<b>TEST GROUP II</b> Solderability	Per MIL-STD-202, method 208	Per MIL-STD-202, method 208
<b>TEST GROUP III</b> Resistance temperature characteristic - TCR Moisture resistance Contact resistance variation - CRV (noise)	± 0.005 %/°C (± 50 ppm/°C) ± 1.0 % 3.0 % or 3 Ω <sup>(7)</sup>	± 0.001 %/°C (± 10 ppm/°C) ± 0.5 % 3 Ω typical, 10 Ω maximum
<b>TEST GROUP IV</b> Settability Shock Setting stability Vibration Setting stability Contact resistance variation - CRV (noise) Salt spray	± 1.0 % ± 1.0 % ± 1.0 % ± 1.0 % ± 1.0 % 3.0 % or 3 Ω <sup>(7)</sup> No corrosion	± 0.1 % ± 0.5 % ± 0.5 % ± 0.5 % ± 0.5 % 3 Ω typical, 10 Ω maximum No corrosion
<b>TEST GROUP V</b> Solder heat Low-temperature operation Setting stability Low-temperature storage High-temperature exposure Setting stability Contact resistance variation - CRV (noise) Integrity of shaft	± 1.0 % ± 1.0 % ± 2.0 % ± 1.0 % ± 3.0 % ± 2.0 % 3 % or 3 Ω <sup>(7)</sup> No loosening or breakage	± 0.1 % ± 0.5 % ± 0.5 % ± 0.5 % ± 0.5 % ± 0.5 % 3 Ω typical, 10 Ω maximum No loosening or breakage
<b>TEST GROUP VI</b> Rotational life (200 cycles) Contact resistance variation - CRV (noise) Terminal strength	± 2.0 % 3 % or 3 Ω <sup>(7)</sup> 2 lbs.	± 2.0 % 3 Ω typical, 10 Ω maximum 2 lbs.
<b>TEST GROUP VII</b> Life (2000 h) at + 85 °C Life (10 000 h) at + 85 °C	± 3.0 % ± 5.0 %	± 0.1 % typical, ± 1.0 % maximum ± 0.1 % typical, ± 1.0 % maximum
<b>TEST GROUP VIII</b> Solvent resistance	No failures	No failures

**Notes**

- (1) Maximum is 1.0 % A.Q.L. standard for all specifications except TCR. (For TCR information, see notes 2 and 3.)
- (2) Maximum TCR applies to the 3 σ (sigma) limit or 99.73 % of a production lot. (Measured end-to-end with wiper off the element.)
- (3) Measurements of TCR through the wiper are influenced more by setting stability and the percentage of the total resistance in use (at the wiper) than by fundamental resistance change due to temperature alone. The parameter shown in table 2 is a 2 s distribution typifying the behavior of the device when used with 40 % or more of the total resistance in use.
- (4) Derated linearly for full power at + 85 °C to zero power at + 150 °C. See Figure 2 on previous page.
- (5) Independent of resistance value. 3 Ω maximum available on special request.
- (6) All ΔR's are measured to the tolerance specified + 0.01 Ω.
- (7) Whichever is greater.  
Special Available Options:  
Special marking  
Burn-in and screening operations.

**VISHAY TRIMMERS ARE INSPECTED**

- 100 % for:
- Immersion
  - Resistance tolerance check
  - End resistance
  - Visual-mechanical
  - Dynamic tests for continuity, CRV
- By sample for:
- TCR
  - DWV

**TABLE 6 - GLOBAL PART NUMBER INFORMATION**

NEW GLOBAL PART NUMBER: Y4053500R000J0L (preferred part number format)

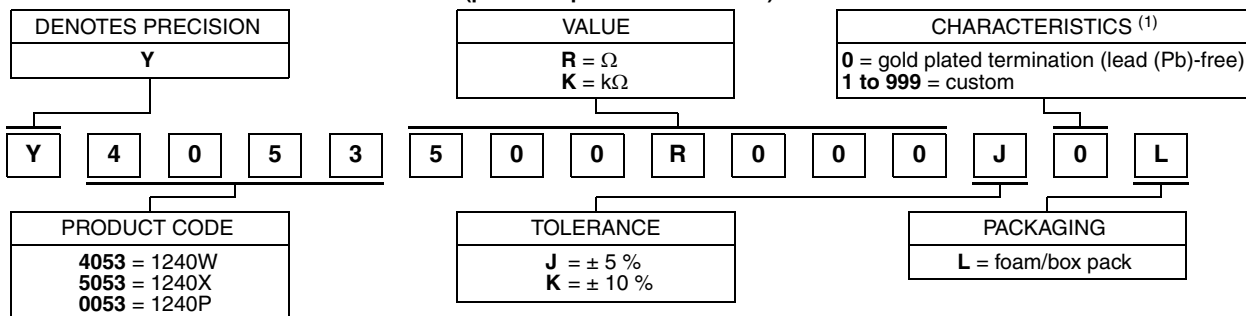

FOR EXAMPLE: ABOVE GLOBAL ORDER Y4053 500R000 J 0 L:

TYPE: 1240W

VALUE: 500.0 Ω

ABSOLUTE TOLERANCE: ± 5.0 %

TERMINATION: gold plated termination (lead (Pb)-free)

PACKAGING: foam/box pack

HISTORICAL PART NUMBER: 1240W 500R00 J B (will continue to be used)

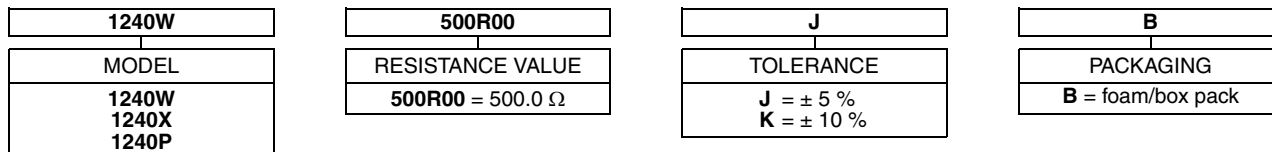

**Note**

<sup>(1)</sup> For non-standard requests, please contact application engineering.

## Disclaimer

ALL PRODUCTS, PRODUCT SPECIFICATIONS AND DATA ARE SUBJECT TO CHANGE WITHOUT NOTICE.

Vishay Precision Group, Inc., its affiliates, agents, and employees, and all persons acting on its or their behalf (collectively, "Vishay Precision Group"), disclaim any and all liability for any errors, inaccuracies or incompleteness contained herein or in any other disclosure relating to any product.

The product specifications do not expand or otherwise modify Vishay Precision Group's terms and conditions of purchase, including but not limited to, the warranty expressed therein.

Vishay Precision Group makes no warranty, representation or guarantee other than as set forth in the terms and conditions of purchase. **To the maximum extent permitted by applicable law, Vishay Precision Group disclaims (i) any and all liability arising out of the application or use of any product, (ii) any and all liability, including without limitation special, consequential or incidental damages, and (iii) any and all implied warranties, including warranties of fitness for particular purpose, non-infringement and merchantability.**

Information provided in datasheets and/or specifications may vary from actual results in different applications and performance may vary over time. Statements regarding the suitability of products for certain types of applications are based on Vishay Precision Group's knowledge of typical requirements that are often placed on Vishay Precision Group products. It is the customer's responsibility to validate that a particular product with the properties described in the product specification is suitable for use in a particular application.

No license, express, implied, or otherwise, to any intellectual property rights is granted by this document, or by any conduct of Vishay Precision Group.

The products shown herein are not designed for use in life-saving or life-sustaining applications unless otherwise expressly indicated. Customers using or selling Vishay Precision Group products not expressly indicated for use in such applications do so entirely at their own risk and agree to fully indemnify Vishay Precision Group for any damages arising or resulting from such use or sale. Please contact authorized Vishay Precision Group personnel to obtain written terms and conditions regarding products designed for such applications.

Product names and markings noted herein may be trademarks of their respective owners.

Компания «Life Electronics» занимается поставками электронных компонентов импортного и отечественного производства от производителей и со складов крупных дистрибьюторов Европы, Америки и Азии.

С конца 2013 года компания активно расширяет линейку поставок компонентов по направлению коаксиальный кабель, кварцевые генераторы и конденсаторы (керамические, пленочные, электролитические), за счёт заключения дистрибьюторских договоров

Мы предлагаем:

- Конкуренспособные цены и скидки постоянным клиентам.
- Специальные условия для постоянных клиентов.
- Подбор аналогов.
- Поставку компонентов в любых объемах, удовлетворяющих вашим потребностям.
- Приемлемые сроки поставки, возможна ускоренная поставка.
- Доставку товара в любую точку России и стран СНГ.
- Комплексную поставку.
- Работу по проектам и поставку образцов.
- Формирование склада под заказчика.
- Сертификаты соответствия на поставляемую продукцию (по желанию клиента).
- Тестирование поставляемой продукции.
- Поставку компонентов, требующих военную и космическую приемку.
- Входной контроль качества.
- Наличие сертификата ISO.

В составе нашей компании организован Конструкторский отдел, призванный помогать разработчикам, и инженерам.

Конструкторский отдел помогает осуществить:

- Регистрацию проекта у производителя компонентов.
- Техническую поддержку проекта.
- Защиту от снятия компонента с производства.
- Оценку стоимости проекта по компонентам.
- Изготовление тестовой платы монтаж и пусконаладочные работы.



Тел: +7 (812) 336 43 04 (многоканальный)

Email: [org@lifeelectronics.ru](mailto:org@lifeelectronics.ru)