

## Optocoupler, Phototransistor Output (Dual, Quad Channel)

### Features

- Current Transfer Ratio at  $I_F = 10 \text{ mA}$
- Isolation Test Voltage, 5300  $V_{RMS}$
- Lead-free component
- Component in accordance to RoHS 2002/95/EC and WEEE 2002/96/EC

### Agency Approvals

- UL1577, File No. E52744 System Code H or J, Double Protection
- CSA 93751
- BSI IEC60950 IEC60065
- DIN EN 60747-5-2 (VDE0884)  
DIN EN 60747-5-5 pending  
Available with Option 1
- FIMKO

### Description

The ILD1/ 2/ 5/ ILQ1/ 2/ 5 are optically coupled isolated pairs employing GaAs infrared LEDs and silicon NPN phototransistor. Signal information, including a DC level, can be transmitted by the drive while maintaining a high degree of electrical isolation between input and output. The ILD1/ 2/ 5/ ILQ1/ 2/ 5 are especially designed for driving medium-speed logic and can be used to eliminate troublesome ground loop and noise problems. Also these couplers can be used to replace relays and transformers in many digital interface applications such as CTR modulation.

The ILD1/ 2/ 5 has two isolated channels in a single DIP package and the ILQ1/ 2/ 5 has four isolated channels per package.

The ILD1/ 2/ 5 has two isolated channels in a single DIP package and the ILQ1/ 2/ 5 has four isolated channels per package.

Dual Channel

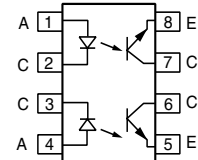
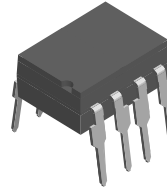

Quad Channel

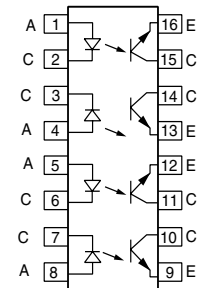
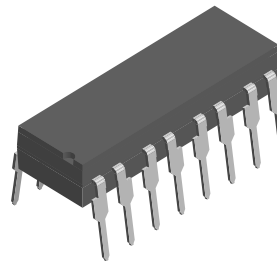

1179012



### Order Information

Part	Remarks
ILD1	CTR > 20 %, DIP-8
ILQ1	CTR > 20 %, DIP-16
ILD2	CTR > 100 %, DIP-8
ILQ2	CTR > 100 %, DIP-16
ILD5	CTR > 50 %, DIP-8
ILQ5	CTR > 50 %, DIP-16
ILD1-X007	CTR > 20 %, SMD-8 (option 7)
ILD1-X009	CTR > 20 %, SMD-8 (option 9)
ILD2-X006	CTR > 100 %, DIP-8 400 mil (option 6)
ILD2-X007	CTR > 100 %, SMD-8 (option 7)
ILD2-X009	CTR > 100 %, SMD-8 (option 9)
ILD5-X009	CTR > 50 %, SMD-8 (option 9)
ILQ1-X009	CTR > 20 %, SMD-16 (option 9)
ILQ2-X009	CTR > 100 %, SMD-16 (option 9)

For additional information on the available options refer to Option Information.

### Absolute Maximum Ratings

$T_{amb} = 25\text{ °C}$ , unless otherwise specified

Stresses in excess of the absolute Maximum Ratings can cause permanent damage to the device. Functional operation of the device is not implied at these or any other conditions in excess of those given in the operational sections of this document. Exposure to absolute Maximum Rating for extended periods of the time can adversely affect reliability.

### Input

Parameter	Test condition	Symbol	Value	Unit
Reverse voltage		$V_R$	6.0	V
Forward current		$I_F$	60	mA
Surge current		$I_{FSM}$	2.5	A
Power dissipation		$P_{diss}$	100	mW
Derate linearly from 25 °C			1.3	mW/°C

### Output

Parameter	Test condition	Part	Symbol	Value	Unit
Collector-emitter reverse voltage		ILD1	$V_{CER}$	50	V
		ILQ1	$V_{CER}$	50	V
		ILD2	$V_{CER}$	70	V
		ILQ2	$V_{CER}$	70	V
		ILD5	$V_{CER}$	70	V
		ILQ5	$V_{CER}$	70	V
Collector current			$I_C$	50	mA
	$t < 1.0\text{ ms}$		$I_C$	400	mA
Power dissipation			$P_{diss}$	200	mW
Derate linearly from 25 °C				2.6	mW/°C

### Coupler

Parameter	Test condition	Symbol	Value	Unit
Isolation test voltage (between emitter and detector referred to standard climate 25 °C/ 50 % RH, DIN 50014)		$V_{ISO}$	5300	$V_{RMS}$
Creepage			$\geq 7.0$	mm
Clearance			$\geq 7.0$	mm
Isolation resistance	$V_{IO} = 500\text{ V}, T_{amb} = 25\text{ °C}$	$R_{IO}$	$10^{12}$	$\Omega$
	$V_{IO} = 500\text{ V}, T_{amb} = 100\text{ °C}$	$R_{IO}$	$10^{11}$	$\Omega$
Package power dissipation		$P_{tot}$	250	mW
Derate linearly from 25 °C			3.3	mW/°C
Storage temperature		$T_{stg}$	- 40 to + 150	°C
Operating temperature		$T_{amb}$	- 40 to + 100	°C
Junction temperature		$T_j$	100	°C
Soldering temperature	2.0 mm from case bottom	$T_{sld}$	260	°C



### Electrical Characteristics

T<sub>amb</sub> = 25 °C, unless otherwise specified

Minimum and maximum values are testing requirements. Typical values are characteristics of the device and are the result of engineering evaluation. Typical values are for information only and are not part of the testing requirements.

### Input

Parameter	Test condition	Symbol	Min	Typ.	Max	Unit
Forward voltage	I <sub>F</sub> = 60 mA	V <sub>F</sub>		1.25	1.65	V
Reverse current	V <sub>R</sub> = 6.0 V	I <sub>R</sub>		0.01	10	μA
Capacitance	V <sub>R</sub> = 0 V, f = 1.0 MHz	C <sub>O</sub>		25		pF
Thermal resistance, junction to lead		T <sub>thJL</sub>		750		K/W

### Output

Parameter	Test condition	Symbol	Min	Typ.	Max	Unit
Collector-emitter capacitance	V <sub>CE</sub> = 5.0 V, f = 1.0 MHz	C <sub>CE</sub>		6.8		pF
Collector-emitter leakage current	V <sub>VCE</sub> = 10 V	I <sub>CEO</sub>		5.0	50	nA
Saturation voltage, collector-emitter	I <sub>CE</sub> = 1.0 mA, I <sub>B</sub> = 20 μA	V <sub>CEsat</sub>		0.25	0.4	V
DC forward current gain	V <sub>CE</sub> = 10 V, I <sub>B</sub> = 20 μA	HFE	200	650	1800	
DC forward current gain saturated	V <sub>CE</sub> = 0.4 V, I <sub>B</sub> = 20 μA	HFE <sub>sat</sub>	120	400	600	
Thermal resistance, junction to lead		R <sub>thjl</sub>		500		K/W

### Coupler

Parameter	Test condition	Symbol	Min	Typ.	Max	Unit
Capacitance (input-output)	V <sub>IO</sub> = 0 V, f = 1.0 MHz	C <sub>IO</sub>		0.8		pF

### Current Transfer Ratio

Parameter	Test condition	Part	Symbol	Min	Typ.	Max	Unit
Current Transfer Ratio (collector-emitter saturated)	I <sub>F</sub> = 10 mA, V <sub>CE</sub> = 0.4 V	ILD1 ILQ1	CTR <sub>CEsat</sub>		75		%
		ILD2 ILQ2	CTR <sub>CEsat</sub>		170		%
		ILD5 ILQ5	CTR <sub>CEsat</sub>		100		%
Current Transfer Ratio (collector-emitter)	I <sub>F</sub> = 10 mA, V <sub>CE</sub> = 10 V	ILD1 ILQ1	CTR <sub>CE</sub>	20	80	300	%
		ILD2 ILQ2	CTR <sub>CE</sub>	100	200	500	%
		ILD5 ILQ5	CTR <sub>CE</sub>	50	130	400	%

### Typical Switching Times

#### Non-saturated Switching Timing

Parameter	Current	Delay	Rise time	Storage	Fall time	Propagation H-L	Propagation L-H
Test condition	$V_{CE} = 5.0 \text{ V}, R_L = 75 \Omega, 50 \% \text{ of } V_{PP}$						
Symbol	$I_F$	$t_D$	$t_r$	$t_S$	$t_f$	$t_{PHL}$	$t_{PLH}$
Unit	mA	$\mu\text{s}$	$\mu\text{s}$	$\mu\text{s}$	$\mu\text{s}$	$\mu\text{s}$	$\mu\text{s}$
ILD1 ILQ1	20	0.8	1.9	0.2	1.4	0.7	1.4
ILD2 ILQ2	5.0	1.7	2.6	0.4	2.2	1.2	2.3
ILD5 ILQ5	10	1.7	2.6	0.4	2.2	1.1	2.5

#### Saturated Switching Timing

Parameter	Current	Delay	Rise time	Storage	Fall time	Propagation H-L	Propagation L-H
Test condition	$V_{CE} = 0.4 \text{ V}, R_L = 1.0 \text{ k}\Omega, V_{CC} = 5.0 \text{ V}, V_{TH} = 1.5 \text{ V}$						
Symbol	$I_F$	$t_D$	$t_r$	$t_S$	$t_f$	$t_{PHL}$	$t_{PLH}$
Unit	mA	$\mu\text{s}$	$\mu\text{s}$	$\mu\text{s}$	$\mu\text{s}$	$\mu\text{s}$	$\mu\text{s}$
ILD1 ILQ1	20	0.8	1.2	7.4	7.6	1.6	8.6
ILD2 ILQ2	5.0	1.0	2.0	5.4	13.5	5.4	7.4
ILD5 ILQ5	10	1.7	7.0	4.6	20	2.6	7.2

#### Common Mode Transient Immunity

Parameter	Test condition	Symbol	Min	Typ.	Max	Unit
Common mode rejection, output high	$V_{CM} = 50 \text{ V}_{P-P}, R_L = 1.0 \text{ k}\Omega, I_F = 0 \text{ mA}$	$CM_H$		5000		V/ $\mu\text{s}$
Common mode rejection, output low	$V_{CM} = 50 \text{ V}_{P-P}, R_L = 1.0 \text{ k}\Omega, I_F = 10 \text{ mA}$	$CM_L$		5000		V/ $\mu\text{s}$
Common mode coupling capacitance		$C_{CM}$		0.01		pF

## Typical Characteristics (Tamb = 25 °C unless otherwise specified)

ild1\_01

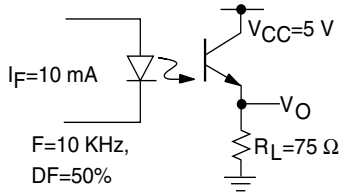
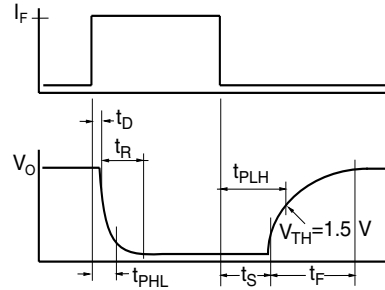

Figure 1. Non-saturated Switching Schematic



ild1\_04

Figure 4. Saturated Switching Timing

ild1\_02

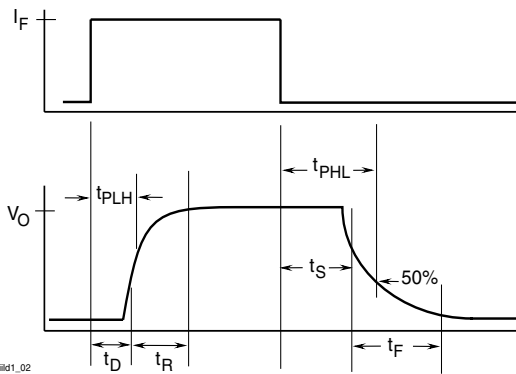
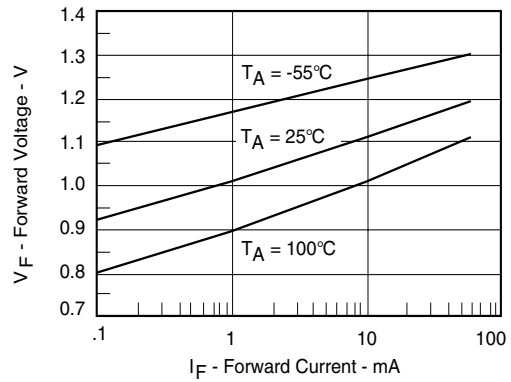

Figure 2. Non-saturated Switching Timing



ild1\_05

Figure 5. Normalized Non-Saturated and Saturated CTR vs. LED Current

ild1\_03

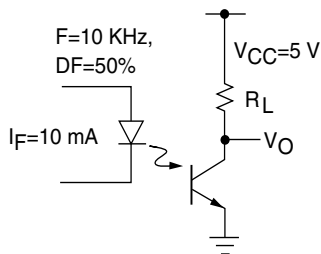
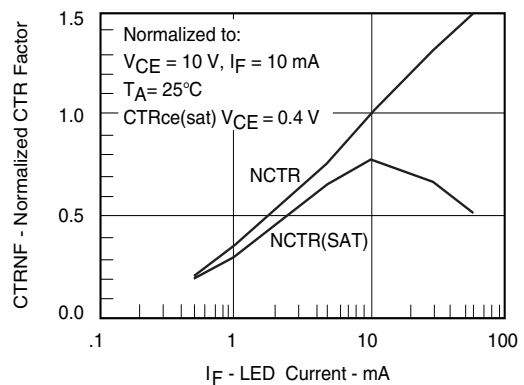
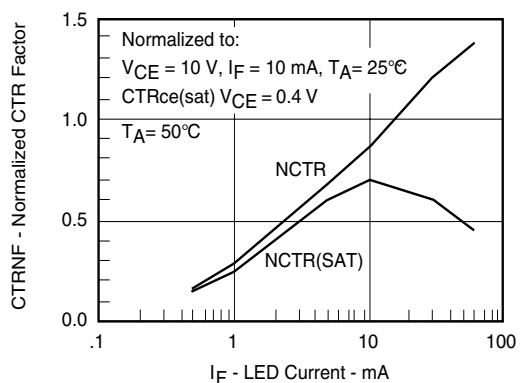

Figure 3. Saturated Switching Schematic



ild1\_06

Figure 6. Normalized Non-Saturated and Saturated CTR vs. LED Current



ild1\_07

Figure 7. Normalized Non-Saturated and Saturated CTR vs. LED Current

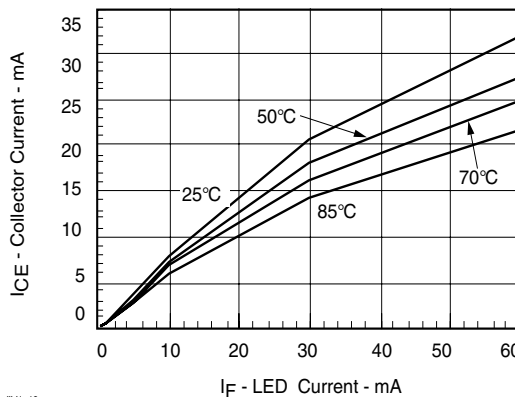

ild1\_10

Figure 10. Collector-Emitter Current vs. Temperature and LED Current

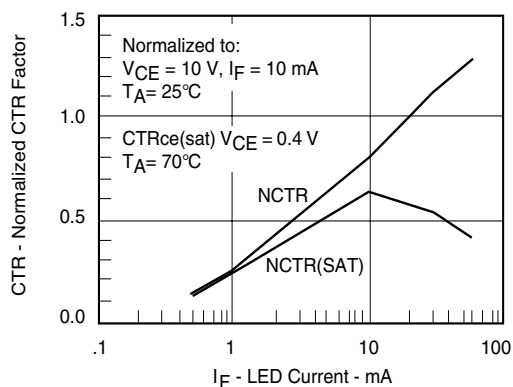

ild1\_08

Figure 8. Normalized Non-Saturated and Saturated CTR vs. LED Current

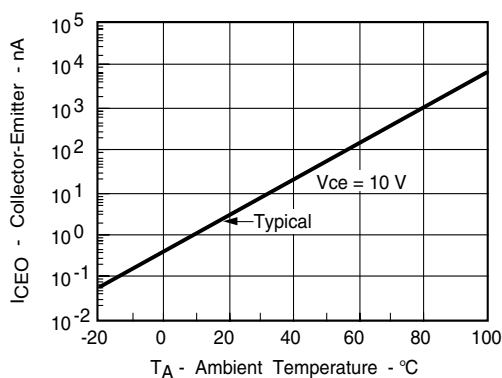

ild1\_11

Figure 11. Collector-Emitter Leakage Current vs. Temp.

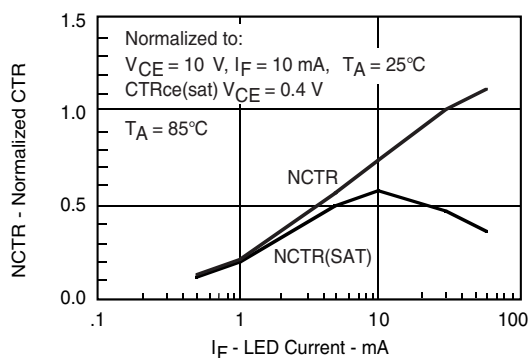

ild1\_09

Figure 9. Normalized Non-Saturated and Saturated CTR vs. LED Current

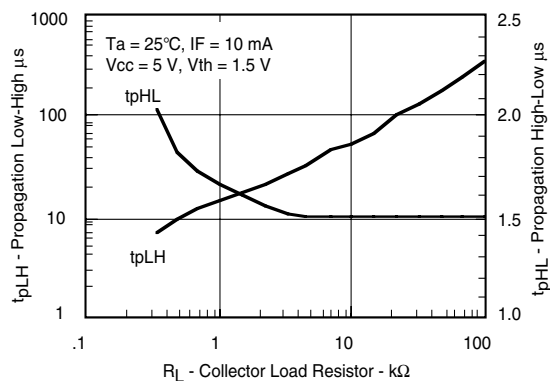

ild1\_12

Figure 12. Propagation Delay vs. Collector Load Resistor

## Package Dimensions in Inches (mm)

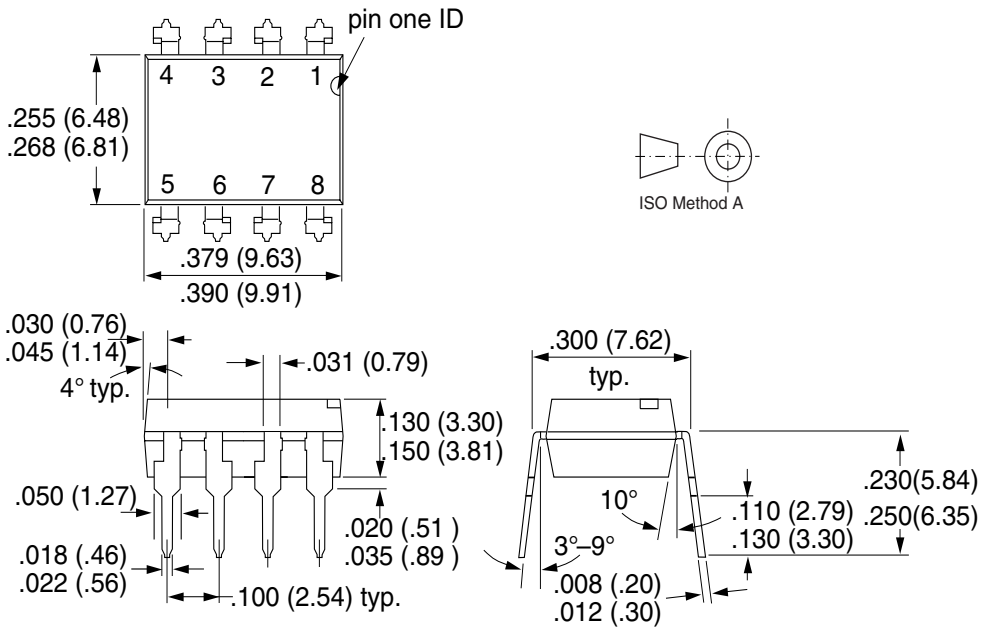

## Package Dimensions in Inches (mm)

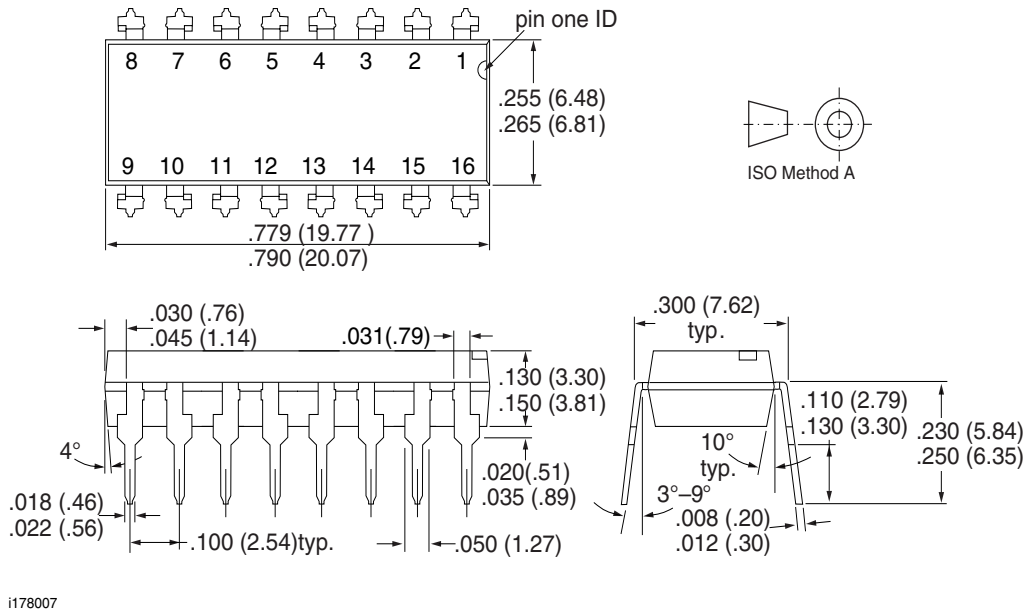

Option 6

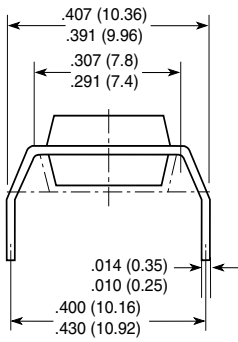

Option 7

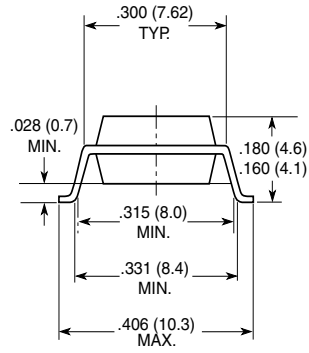

Option 9

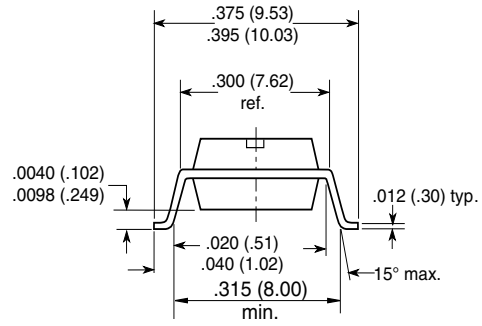

18450





## **Ozone Depleting Substances Policy Statement**

It is the policy of Vishay Semiconductor GmbH to

1. Meet all present and future national and international statutory requirements.
2. Regularly and continuously improve the performance of our products, processes, distribution and operating systems with respect to their impact on the health and safety of our employees and the public, as well as their impact on the environment.

It is particular concern to control or eliminate releases of those substances into the atmosphere which are known as ozone depleting substances (ODSs).

The Montreal Protocol (1987) and its London Amendments (1990) intend to severely restrict the use of ODSs and forbid their use within the next ten years. Various national and international initiatives are pressing for an earlier ban on these substances.

Vishay Semiconductor GmbH has been able to use its policy of continuous improvements to eliminate the use of ODSs listed in the following documents.

1. Annex A, B and list of transitional substances of the Montreal Protocol and the London Amendments respectively
2. Class I and II ozone depleting substances in the Clean Air Act Amendments of 1990 by the Environmental Protection Agency (EPA) in the USA
3. Council Decision 88/540/EEC and 91/690/EEC Annex A, B and C (transitional substances) respectively.

Vishay Semiconductor GmbH can certify that our semiconductors are not manufactured with ozone depleting substances and do not contain such substances.

We reserve the right to make changes to improve technical design and may do so without further notice.

Parameters can vary in different applications. All operating parameters must be validated for each customer application by the customer. Should the buyer use Vishay Semiconductors products for any unintended or unauthorized application, the buyer shall indemnify Vishay Semiconductors against all claims, costs, damages, and expenses, arising out of, directly or indirectly, any claim of personal damage, injury or death associated with such unintended or unauthorized use.

Vishay Semiconductor GmbH, P.O.B. 3535, D-74025 Heilbronn, Germany  
Telephone: 49 (0)7131 67 2831, Fax number: 49 (0)7131 67 2423

Компания «Life Electronics» занимается поставками электронных компонентов импортного и отечественного производства от производителей и со складов крупных дистрибьюторов Европы, Америки и Азии.

С конца 2013 года компания активно расширяет линейку поставок компонентов по направлению коаксиальный кабель, кварцевые генераторы и конденсаторы (керамические, пленочные, электролитические), за счёт заключения дистрибьюторских договоров

Мы предлагаем:

- Конкурентоспособные цены и скидки постоянным клиентам.
- Специальные условия для постоянных клиентов.
- Подбор аналогов.
- Поставку компонентов в любых объемах, удовлетворяющих вашим потребностям.
- Приемлемые сроки поставки, возможна ускоренная поставка.
- Доставку товара в любую точку России и стран СНГ.
- Комплексную поставку.
- Работу по проектам и поставку образцов.
- Формирование склада под заказчика.
- Сертификаты соответствия на поставляемую продукцию (по желанию клиента).
- Тестирование поставляемой продукции.
- Поставку компонентов, требующих военную и космическую приемку.
- Входной контроль качества.
- Наличие сертификата ISO.

В составе нашей компании организован Конструкторский отдел, призванный помогать разработчикам, и инженерам.

Конструкторский отдел помогает осуществить:

- Регистрацию проекта у производителя компонентов.
- Техническую поддержку проекта.
- Защиту от снятия компонента с производства.
- Оценку стоимости проекта по компонентам.
- Изготовление тестовой платы монтаж и пусконаладочные работы.



Тел: +7 (812) 336 43 04 (многоканальный)

Email: [org@lifeelectronics.ru](mailto:org@lifeelectronics.ru)