

LISA2-O-90-CLIP

~20° x 50° turned oval beam optimized for CREE XP-E. 6.8 mm high variant with clip installation.

TECHNICAL SPECIFICATIONS:

Dimensions	Ø 9.9 mm
Height	6.8 mm
Fastening	glue, clips
ROHS compliant	yes ⓘ

MATERIAL SPECIFICATIONS:

Component	Type	Material	Colour	Finish
LISA2-O-XP	Single lens	PMMA	clear	
LISA2-HLD-CLIP16-XP	Holder	PC	black	



ORDERING INFORMATION:

Component		Qty in box	MOQ	MPQ	Box weight (kg)
FP11856_LISA2-O-90-CLIP	Single lens	2000		100	1.4
» Box size:					

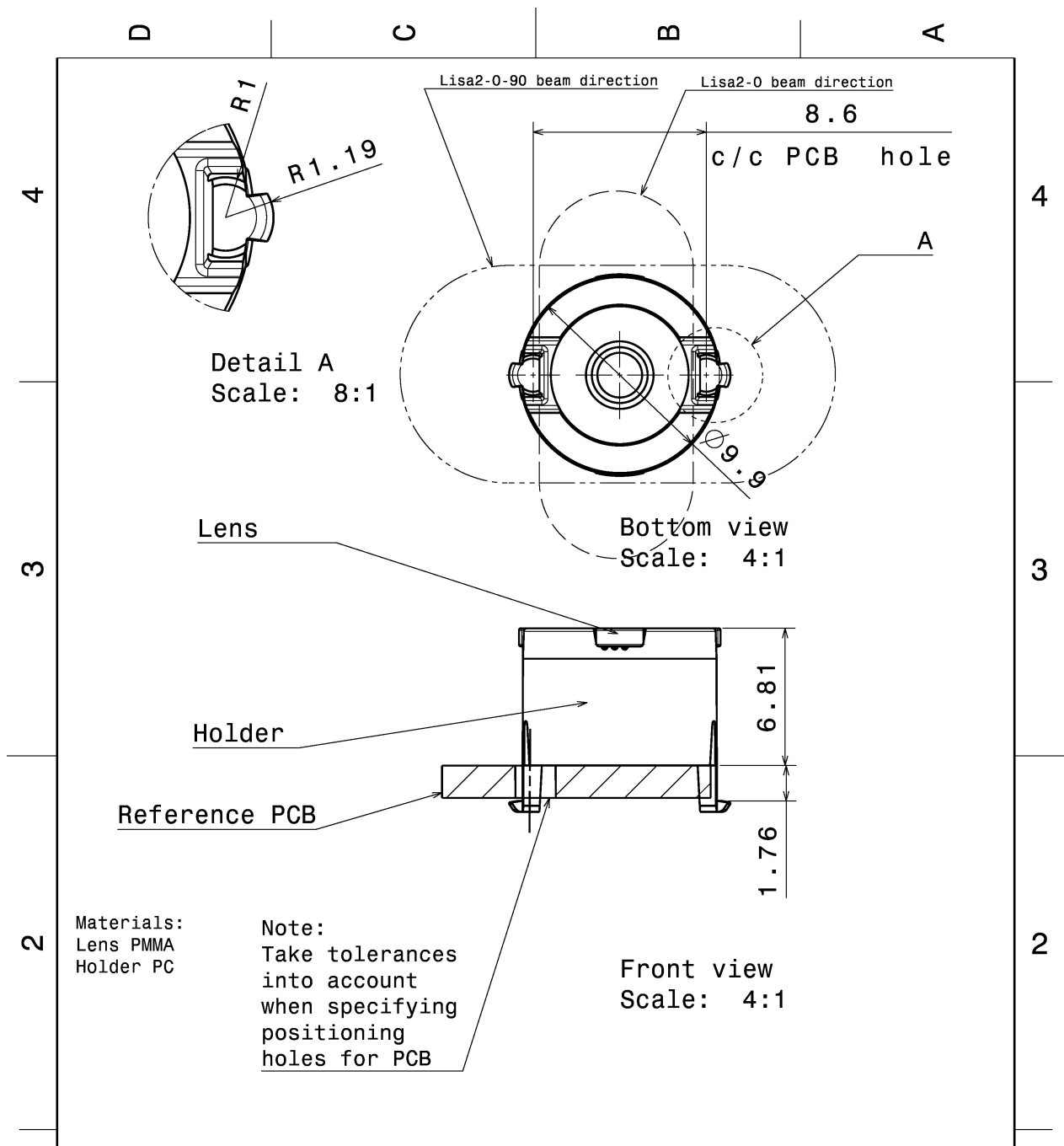

Materials:
 Lens PMMA
 Holder PC

Note:
 Take tolerances into account when specifying positioning holes for PCB

This drawing is our property. It can't be reproduced or communicated without our written agreement.



Ledil Oy
 Tehdaskatu 13
 FIN-24100 SALO
 Finland

DRAWN BY ch		DATE 20.7.2011		DRAWING TITLE Datasheet Lisa2-clip16-XP series Assy			
CHECKED BY sn		DATE 20.7.2011		SIZE A4	DRAWING NUMBER		REV 2
DESIGNED BY hh		DATE 19.10.2009		SCALE 4:1	WEIGHT (g)	SHEET 1/1	

PHOTOMETRIC DATA (MEASURED):



LED XP-E
 FWHM 48.0 + 18.0°
 Efficiency 83 %
 LEDs/each optic 1
 Light colour White
 Required components:

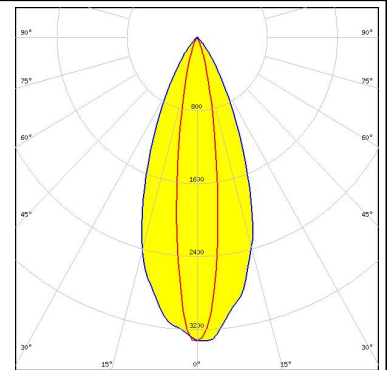

LED XP-G
 FWHM 48.0 + 18.0°
 Efficiency 86 %
 LEDs/each optic 1
 Light colour White
 Required components:



LED LUXEON C
 FWHM 17.0 + 47.0°
 Efficiency 80 %
 Peak intensity 2.5 cd/lm
 LEDs/each optic 1
 Light colour White
 Required components:

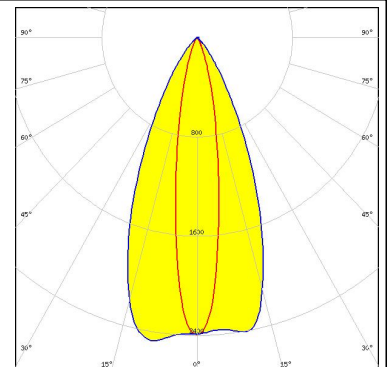
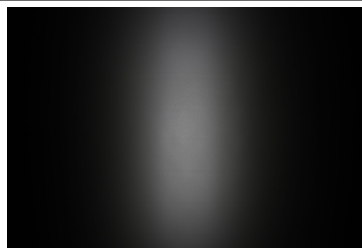

LED LUXEON Z ES
 FWHM 18.0 + 49.0°
 Efficiency 80 %
 Peak intensity 2.2 cd/lm
 LEDs/each optic 1
 Light colour White
 Required components:

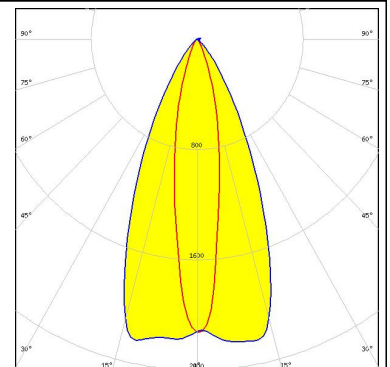
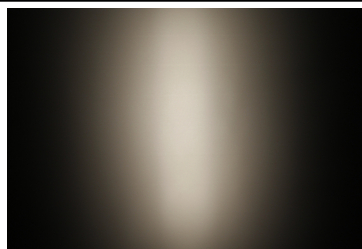

PHOTOMETRIC DATA (MEASURED):

OSRAM
Opto Semiconductors

LED SFH 4170S
FWHM 13.0 + 46.0°
Efficiency %
LEDs/each optic 1
Light colour IR
Required components:

OSRAM
Opto Semiconductors

LED SFH 4180S
FWHM 13.0 + 48.0°
Efficiency %
LEDs/each optic 1
Light colour IR
Required components:

PHOTOMETRIC DATA (SIMULATED):

CREE

LED XQ-E HD
FWHM 40.0 + 13.0°
Efficiency 86 %
Peak intensity 3.5 cd/lm
LEDs/each optic 1
Light colour White
Required components:

CREE

LED XQ-E HI
FWHM 46.0 + 11.0°
Efficiency 83 %
Peak intensity 3.8 cd/lm
LEDs/each optic 1
Light colour White
Required components:

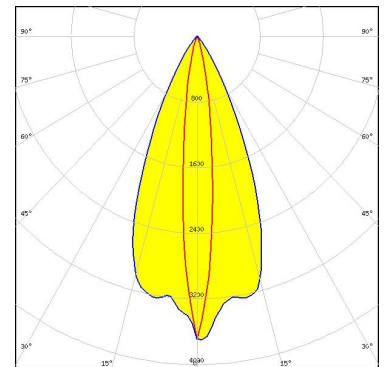

SHARP

LED Double Dome (GM2BB)
FWHM 48.0 + 20.0°
Efficiency %
LEDs/each optic 1
Light colour White
Required components:

GENERAL INFORMATION:

NOTE: The typical beam angle will be changed by different color, chip size and chip position tolerance. The typical total beam angle is the full angle measured where the luminous intensity is half of the peak value.

MATERIALS:

As part of our continuous research and improvement processes, and to ensure the best possible quality and availability of our products, LEDiL reserves the right to change material grades without notice.

PRODUCT DATA USER AGREEMENT AND DISCLAIMER:

The measured data in the provided downloadable LEDiL Product Datasheets and Mechanical 2D-Drawings is rounded and provided as reference for planning. LEDiL Oy's optical specifications have been verified by conducting performance testing of the products in accordance with the company's quality system. The reported data are averaged results of multiple measurements with typical variation. LEDiL Oy reserves the right to without prior notification make changes and improvements to its products.

LEDiL Oy assumes neither warranty, nor guarantee nor any other liability of any kind for the contents and correctness of the provided data. The provided data has been generated with highest diligence but the provided data may in reality not represent the complete possible variation range of all intrinsic parameters. Therefore, in certain cases a deviation from the provided data could occur.

LEDiL Oy reserves the right to undertake technical changes of its products without further notification which could lead to changes in the provided data. LEDiL Oy assumes no liability of any kind for the possible deviation from any provided data or any other damage resulting from the usage of the provided data.

The user agrees to this disclaimer and user agreement with the download or usage of the provided files.

LEDiL Oy

Joensuunkatu 13
FI-24240 SALO
Finland

LEDiL Inc.

228 West Page Street
Suite D
Sycamore IL 60178
USA

Local sales and technical support

[www.ledil.com/
where_to_buy](http://www.ledil.com/where_to_buy)

Shipping locations

Salo, Finland
Hong Kong, China

Distribution Partners

[www.ledil.com/
where_to_buy](http://www.ledil.com/where_to_buy)

Компания «Life Electronics» занимается поставками электронных компонентов импортного и отечественного производства от производителей и со складов крупных дистрибьюторов Европы, Америки и Азии.

С конца 2013 года компания активно расширяет линейку поставок компонентов по направлению коаксиальный кабель, кварцевые генераторы и конденсаторы (керамические, пленочные, электролитические), за счёт заключения дистрибьюторских договоров

Мы предлагаем:

- Конкурентоспособные цены и скидки постоянным клиентам.
- Специальные условия для постоянных клиентов.
- Подбор аналогов.
- Поставку компонентов в любых объемах, удовлетворяющих вашим потребностям.
- Приемлемые сроки поставки, возможна ускоренная поставка.
- Доставку товара в любую точку России и стран СНГ.
- Комплексную поставку.
- Работу по проектам и поставку образцов.
- Формирование склада под заказчика.
- Сертификаты соответствия на поставляемую продукцию (по желанию клиента).
- Тестирование поставляемой продукции.
- Поставку компонентов, требующих военную и космическую приемку.
- Входной контроль качества.
- Наличие сертификата ISO.

В составе нашей компании организован Конструкторский отдел, призванный помогать разработчикам, и инженерам.

Конструкторский отдел помогает осуществить:

- Регистрацию проекта у производителя компонентов.
- Техническую поддержку проекта.
- Защиту от снятия компонента с производства.
- Оценку стоимости проекта по компонентам.
- Изготовление тестовой платы монтаж и пусконаладочные работы.



Тел: +7 (812) 336 43 04 (многоканальный)

Email: org@lifeelectronics.ru