

# PNP - 2N6107, 2N6109, 2N6111; NPN - 2N6288, 2N6292



ON Semiconductor®

<http://onsemi.com>

## Complementary Silicon Plastic Power Transistors

These devices are designed for use in general-purpose amplifier and switching applications.

### Features

- DC Current Gain Specified to 7.0 Amperes
  - $h_{FE} = 30-150 @ I_C$
  - $= 3.0 \text{ Adc} - 2N6111, 2N6288$
  - $= 2.3 (\text{Min}) @ I_C = 7.0 \text{ Adc} - \text{All Devices}$
- Collector-Emitter Sustaining Voltage -
  - $V_{CEO(\text{sus})} = 30 \text{ Vdc (Min)} - 2N6111, 2N6288$
  - $= 50 \text{ Vdc (Min)} - 2N6109$
  - $= 70 \text{ Vdc (Min)} - 2N6107, 2N6292$
- High Current Gain - Bandwidth Product
  - $f_T = 4.0 \text{ MHz (Min)} @ I_C = 500 \text{ mAdc} - 2N6288, 90, 92$
  - $= 10 \text{ MHz (Min)} @ I_C = 500 \text{ mAdc} - 2N6107, 09, 11$
- TO-220AB Compact Package
- Pb-Free Packages are Available\*

### MAXIMUM RATINGS (Note 1)

| Rating  | Symbol         | Value          | Unit                     |
|---|----------------|----------------|--------------------------|
| Collector-Emitter Voltage<br>2N6111, 2N6288<br>2N6109<br>2N6107, 2N6292               | $V_{CEO}$      | 30<br>50<br>70 | Vdc                      |
| Collector-Base Voltage<br>2N6111, 2N6288<br>2N6109<br>2N6107, 2N6292                  | $V_{CB}$       | 40<br>60<br>80 | Vdc                      |
| Emitter-Base Voltage  | $V_{EB}$       | 5.0            | Vdc                      |
| Collector Current - Continuous<br>- Peak  | $I_C$          | 7.0<br>10      | Adc                      |
| Base Current  | $I_B$          | 3.0            | Adc                      |
| Total Power Dissipation @ $T_C = 25^\circ\text{C}$<br>Derate above $25^\circ\text{C}$ | $P_D$          | 40<br>0.32     | W<br>W/ $^\circ\text{C}$ |
| Operating and Storage Junction<br>Temperature Range                                   | $T_J, T_{stg}$ | -65 to +150    | $^\circ\text{C}$         |

### THERMAL CHARACTERISTICS

| Characteristics                      | Symbol          | Max   | Unit               |
|--------------------------------------|-----------------|-------|--------------------|
| Thermal Resistance, Junction-to-Case | $R_{\theta JC}$ | 3.125 | $^\circ\text{C/W}$ |

Stresses exceeding Maximum Ratings may damage the device. Maximum Ratings are stress ratings only. Functional operation above the Recommended Operating Conditions is not implied. Extended exposure to stresses above the Recommended Operating Conditions may affect device reliability.

1. Indicates JEDEC Registered Data.

\*For additional information on our Pb-Free strategy and soldering details, please download the ON Semiconductor Soldering and Mounting Techniques Reference Manual, SOLDERRM/D.

## 7 AMPERE POWER TRANSISTORS COMPLEMENTARY SILICON 30 - 50 - 70 VOLTS, 40 WATTS

### MARKING DIAGRAM

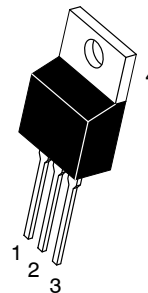

TO-220AB  
CASE 221A  
STYLE 1

PIN 1. BASE  
2. COLLECTOR  
3. EMITTER  
4. COLLECTOR

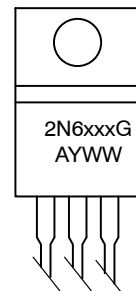

2N6xxx = Specific Device Code  
xxx = See Table on Page 4  
G = Pb-Free Package  
A = Assembly Location  
Y = Year  
WW = Work Week

### ORDERING INFORMATION

See detailed ordering, marking, and shipping information in the package dimensions section on page 4 of this data sheet.

PNP – 2N6107, 2N6109, 2N6111; NPN – 2N6288, 2N6292

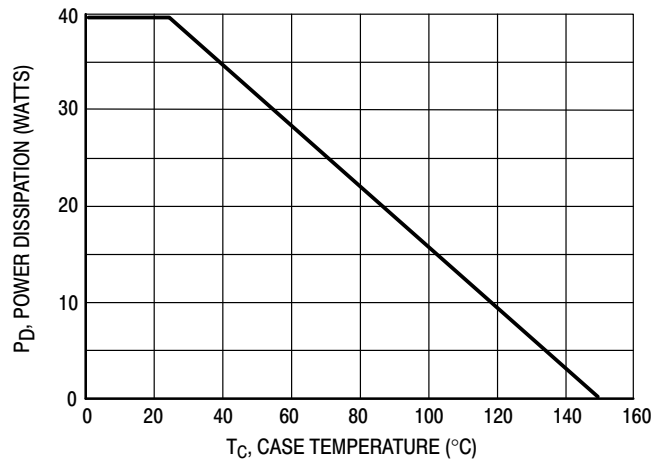

Figure 1. Power Derating

**ELECTRICAL CHARACTERISTICS** (T<sub>C</sub> = 25°C unless otherwise noted) (Note 2)

| Characteristic   | Symbol                | Min | Max | Unit |
|--|-----------------------|-----|-----|------|
| <b>OFF CHARACTERISTICS</b>   |                       |     |     |      |
| Collector–Emitter Sustaining Voltage (Note 3)<br>(I <sub>C</sub> = 100 mAdc, I <sub>B</sub> = 0) | V <sub>CEO(sus)</sub> | 30  | –   | Vdc  |
| 2N6111, 2N6288   |                       | 50  | –   |      |
| 2N6109   |                       | 70  | –   |      |
| 2N6107, 2N6292   |                       |     |     |      |
| Collector Cutoff Current<br>(V <sub>CE</sub> = 20 Vdc, I <sub>B</sub> = 0)                       | I <sub>CEO</sub>      | –   | 1.0 | mAdc |
| (V <sub>CE</sub> = 40 Vdc, I <sub>B</sub> = 0)   |                       | –   | 1.0 |      |
| (V <sub>CE</sub> = 60 Vdc, I <sub>B</sub> = 0)   |                       | –   | 1.0 |      |
| Collector Cutoff Current<br>(V <sub>CE</sub> = 40 Vdc, V <sub>EB(off)</sub> = 1.5 Vdc)           | I <sub>CEX</sub>      | –   | 100 | μAdc |
| (V <sub>CE</sub> = 60 Vdc, V <sub>EB(off)</sub> = 1.5 Vdc)                                       |                       | –   | 100 |      |
| (V <sub>CE</sub> = 80 Vdc, V <sub>EB(off)</sub> = 1.5 Vdc)                                       |                       | –   | 100 |      |
| (V <sub>CE</sub> = 30 Vdc, V <sub>EB(off)</sub> = 1.5 Vdc, T <sub>C</sub> = 150°C)               |                       | –   | 2.0 | mAdc |
| (V <sub>CE</sub> = 50 Vdc, V <sub>EB(off)</sub> = 1.5 Vdc, T <sub>C</sub> = 150°C)               |                       | –   | 2.0 |      |
| (V <sub>CE</sub> = 70 Vdc, V <sub>EB(off)</sub> = 1.5 Vdc, T <sub>C</sub> = 150°C)               |                       | –   | 2.0 |      |
| Emitter Cutoff Current (V <sub>BE</sub> = 5.0 Vdc, I <sub>C</sub> = 0)                           | I <sub>EBO</sub>      | –   | 1.0 | mAdc |

**ON CHARACTERISTICS** (Note 3)

|   |                      |     |     |     |
|---|----------------------|-----|-----|-----|
| DC Current Gain<br>(I <sub>C</sub> = 2.0 Adc, V <sub>CE</sub> = 4.0 Vdc)                  | h <sub>FE</sub>      | 30  | 150 | –   |
| (I <sub>C</sub> = 2.5 Adc, V <sub>CE</sub> = 4.0 Vdc)                                     |                      | 30  | 150 |     |
| (I <sub>C</sub> = 3.0 Adc, V <sub>CE</sub> = 4.0 Vdc)                                     |                      | 30  | 150 |     |
| (I <sub>C</sub> = 7.0 Adc, V <sub>CE</sub> = 4.0 Vdc)                                     |                      | 2.3 | –   |     |
| Collector–Emitter Saturation Voltage (I <sub>C</sub> = 7.0 Adc, I <sub>B</sub> = 3.0 Adc) | V <sub>CE(sat)</sub> | –   | 3.5 | Vdc |
| Base–Emitter On Voltage (I <sub>C</sub> = 7.0 Adc, V <sub>CE</sub> = 4.0 Vdc)             | V <sub>BE(on)</sub>  | –   | 3.0 | Vdc |

**DYNAMIC CHARACTERISTICS**

|  |                 |     |     |     |
|--|-----------------|-----|-----|-----|
| Current Gain — Bandwidth Product (Note 4)<br>(I <sub>C</sub> = 500 mAdc, V <sub>CE</sub> = 4.0 Vdc, f <sub>test</sub> = 1.0 MHz) | f <sub>T</sub>  | 4.0 | –   | MHz |
| 2N6288, 92   |                 | 10  | –   |     |
| 2N6107, 09, 11   |                 |     |     |     |
| Output Capacitance (V <sub>CB</sub> = 10 Vdc, I <sub>E</sub> = 0, f = 1.0 MHz)   | C <sub>ob</sub> | –   | 250 | pF  |
| Small–Signal Current Gain (I <sub>C</sub> = 0.5 Adc, V <sub>CE</sub> = 4.0 Vdc, f = 50 kHz)                                      | h <sub>fe</sub> | 20  | –   | –   |

2. Indicates JEDEC Registered Data.

3. Pulse Test: Pulse Width ≤ 300 μs, Duty Cycle ≤ 2.0%.

4. f<sub>T</sub> = |h<sub>fe</sub>| • f<sub>test</sub>

PNP – 2N6107, 2N6109, 2N6111; NPN – 2N6288, 2N6292

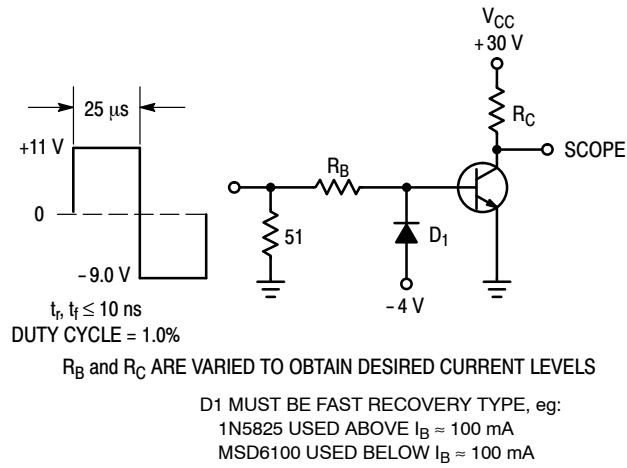

Figure 2. Switching Time Test Circuit

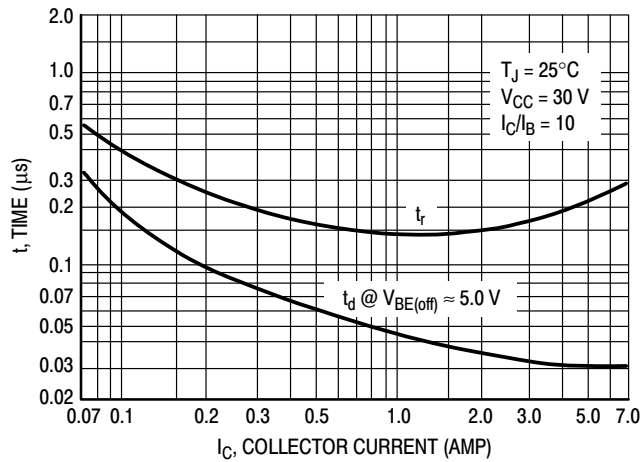

Figure 3. Turn-On Time

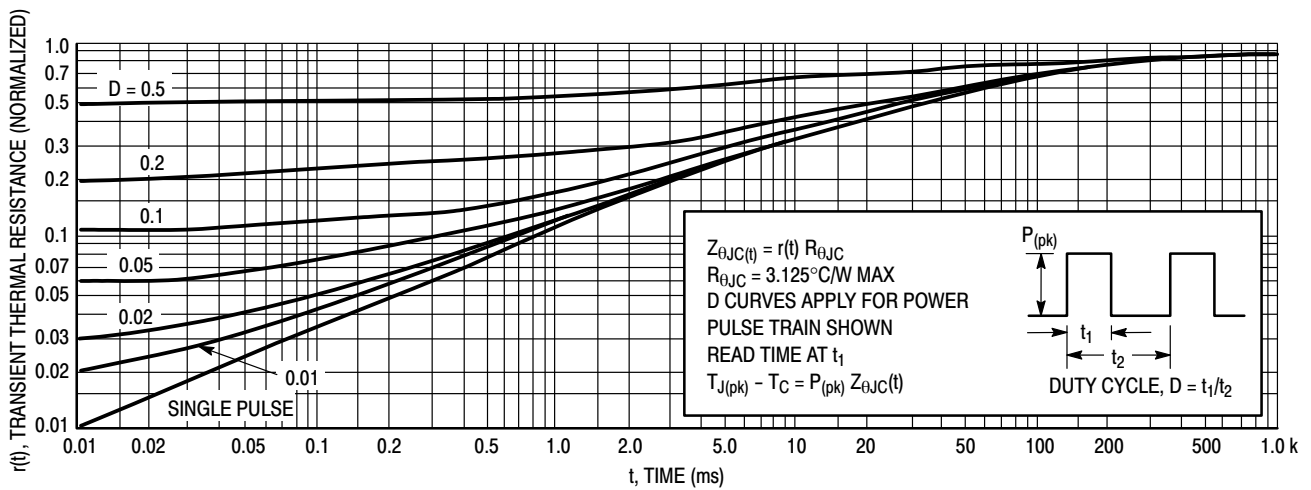
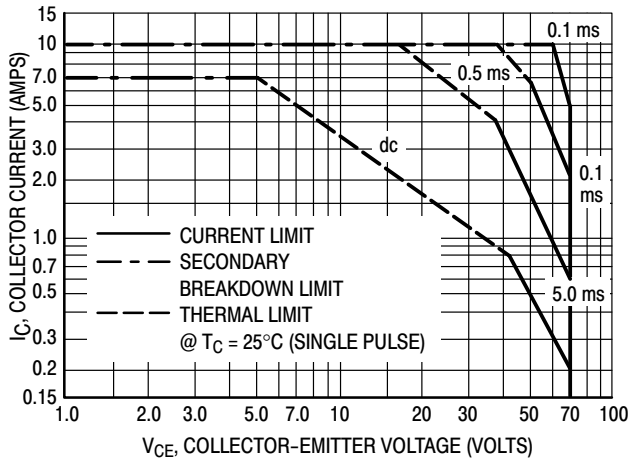

Figure 4. Thermal Response

## PNP – 2N6107, 2N6109, 2N6111; NPN – 2N6288, 2N6292



**Figure 5. Active-Region Safe Operating Area**

There are two limitations on the power handling ability of a transistor: average junction temperature and second breakdown. Safe operating area curves indicate  $I_C - V_{CE}$  limits of the transistor that must be observed for reliable operation; i.e., the transistor must not be subjected to greater dissipation than the curves indicate.

The data of Figure 5 is based on  $T_{J(pk)} = 150^\circ\text{C}$ ;  $T_C$  is variable depending on conditions. Second breakdown pulse limits are valid for duty cycles to 10% provided  $T_{J(pk)} \leq 150^\circ\text{C}$ .  $T_{J(pk)}$  may be calculated from the data in Figure 4. At high case temperatures, thermal limitations will reduce the power that can be handled to values less than the limitations imposed by second breakdown.

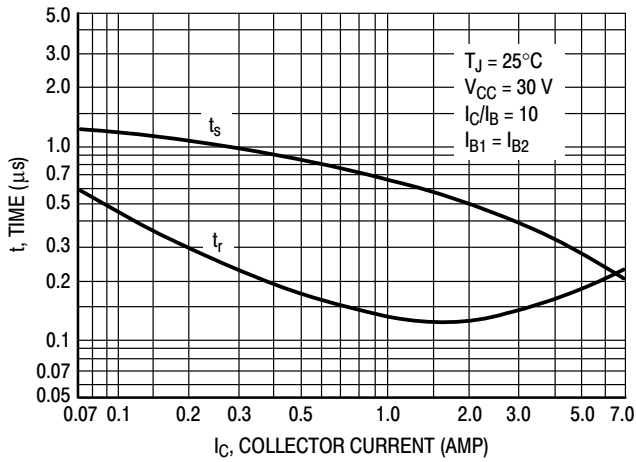

**Figure 6. Turn-Off Time**

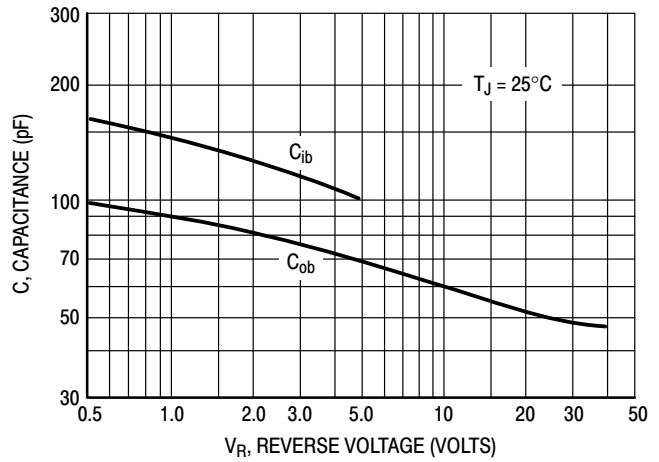

**Figure 7. Capacitance**

### ORDERING INFORMATION

| Device  | Device Marking | Package            | Shipping        |
|---------|----------------|--------------------|-----------------|
| 2N6107  | 2N6107         | TO-220AB           | 50 Units / Rail |
| 2N6107G |                | TO-220AB (Pb-Free) |                 |
| 2N6109  | 2N6109         | TO-220AB           | 50 Units / Rail |
| 2N6109G |                | TO-220AB (Pb-Free) |                 |
| 2N6111  | 2N6111         | TO-220AB           | 50 Units / Rail |
| 2N6111G |                | TO-220AB (Pb-Free) |                 |
| 2N6288  | 2N6288         | TO-220AB           | 50 Units / Rail |
| 2N6288G |                | TO-220AB (Pb-Free) |                 |
| 2N6292  | 2N6292         | TO-220AB           | 50 Units / Rail |
| 2N6292G |                | TO-220AB (Pb-Free) |                 |

# PNP – 2N6107, 2N6109, 2N6111; NPN – 2N6288, 2N6292

## PACKAGE DIMENSIONS

### TO-220 CASE 221A-09 ISSUE AG

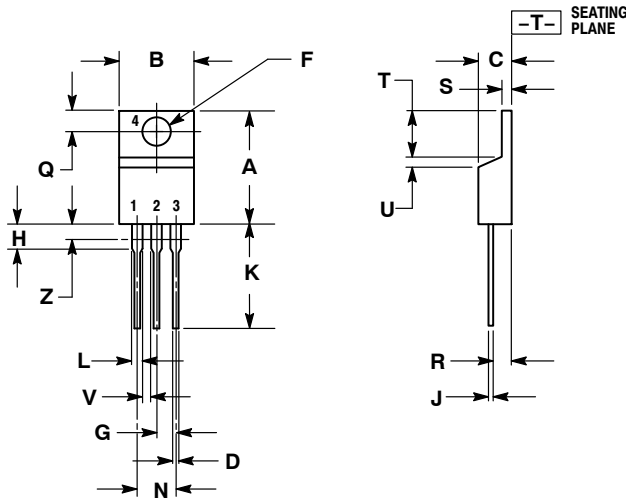

#### NOTES:

1. DIMENSIONING AND TOLERANCING PER ANSI Y14.5M, 1982.
2. CONTROLLING DIMENSION: INCH.
3. DIMENSION Z DEFINES A ZONE WHERE ALL BODY AND LEAD IRREGULARITIES ARE ALLOWED.

| DIM | INCHES |       | MILLIMETERS |       |
|-----|--------|-------|-------------|-------|
|     | MIN    | MAX   | MIN         | MAX   |
| A   | 0.570  | 0.620 | 14.48       | 15.75 |
| B   | 0.380  | 0.405 | 9.66        | 10.28 |
| C   | 0.160  | 0.190 | 4.07        | 4.82  |
| D   | 0.025  | 0.036 | 0.64        | 0.91  |
| F   | 0.142  | 0.161 | 3.61        | 4.09  |
| G   | 0.095  | 0.105 | 2.42        | 2.66  |
| H   | 0.110  | 0.161 | 2.80        | 4.10  |
| J   | 0.014  | 0.025 | 0.36        | 0.64  |
| K   | 0.500  | 0.562 | 12.70       | 14.27 |
| L   | 0.045  | 0.060 | 1.15        | 1.52  |
| N   | 0.190  | 0.210 | 4.83        | 5.33  |
| Q   | 0.100  | 0.120 | 2.54        | 3.04  |
| R   | 0.080  | 0.110 | 2.04        | 2.79  |
| S   | 0.045  | 0.055 | 1.15        | 1.39  |
| T   | 0.235  | 0.255 | 5.97        | 6.47  |
| U   | 0.000  | 0.050 | 0.00        | 1.27  |
| V   | 0.045  | ---   | 1.15        | ---   |
| Z   | ---    | 0.080 | ---         | 2.04  |

#### STYLE 1:

1. BASE
2. COLLECTOR
3. EMITTER
4. COLLECTOR

ON Semiconductor and  are registered trademarks of Semiconductor Components Industries, LLC (SCILLC). SCILLC reserves the right to make changes without further notice to any products herein. SCILLC makes no warranty, representation or guarantee regarding the suitability of its products for any particular purpose, nor does SCILLC assume any liability arising out of the application or use of any product or circuit, and specifically disclaims any and all liability, including without limitation special, consequential or incidental damages. "Typical" parameters which may be provided in SCILLC data sheets and/or specifications can and do vary in different applications and actual performance may vary over time. All operating parameters, including "Typicals" must be validated for each customer application by customer's technical experts. SCILLC does not convey any license under its patent rights nor the rights of others. SCILLC products are not designed, intended, or authorized for use as components in systems intended for surgical implant into the body, or other applications intended to support or sustain life, or for any other application in which the failure of the SCILLC product could create a situation where personal injury or death may occur. Should Buyer purchase or use SCILLC products for any such unintended or unauthorized application, Buyer shall indemnify and hold SCILLC and its officers, employees, subsidiaries, affiliates, and distributors harmless against all claims, costs, damages, and expenses, and reasonable attorney fees arising out of, directly or indirectly, any claim of personal injury or death associated with such unintended or unauthorized use, even if such claim alleges that SCILLC was negligent regarding the design or manufacture of the part. SCILLC is an Equal Opportunity/Affirmative Action Employer. This literature is subject to all applicable copyright laws and is not for resale in any manner.

#### PUBLICATION ORDERING INFORMATION

##### LITERATURE FULFILLMENT:

Literature Distribution Center for ON Semiconductor  
P.O. Box 5163, Denver, Colorado 80217 USA  
Phone: 303-675-2175 or 800-344-3860 Toll Free USA/Canada  
Fax: 303-675-2176 or 800-344-3867 Toll Free USA/Canada  
Email: orderlit@onsemi.com

N. American Technical Support: 800-282-9855 Toll Free  
USA/Canada  
Europe, Middle East and Africa Technical Support:  
Phone: 421 33 790 2910  
Japan Customer Focus Center  
Phone: 81-3-5817-1050

ON Semiconductor Website: [www.onsemi.com](http://www.onsemi.com)

Order Literature: <http://www.onsemi.com/orderlit>

For additional information, please contact your local Sales Representative

Компания «Life Electronics» занимается поставками электронных компонентов импортного и отечественного производства от производителей и со складов крупных дистрибьюторов Европы, Америки и Азии.

С конца 2013 года компания активно расширяет линейку поставок компонентов по направлению коаксиальный кабель, кварцевые генераторы и конденсаторы (керамические, пленочные, электролитические), за счёт заключения дистрибьюторских договоров

Мы предлагаем:

- Конкурентоспособные цены и скидки постоянным клиентам.
- Специальные условия для постоянных клиентов.
- Подбор аналогов.
- Поставку компонентов в любых объемах, удовлетворяющих вашим потребностям.
- Приемлемые сроки поставки, возможна ускоренная поставка.
- Доставку товара в любую точку России и стран СНГ.
- Комплексную поставку.
- Работу по проектам и поставку образцов.
- Формирование склада под заказчика.
- Сертификаты соответствия на поставляемую продукцию (по желанию клиента).
- Тестирование поставляемой продукции.
- Поставку компонентов, требующих военную и космическую приемку.
- Входной контроль качества.
- Наличие сертификата ISO.

В составе нашей компании организован Конструкторский отдел, призванный помогать разработчикам, и инженерам.

Конструкторский отдел помогает осуществить:

- Регистрацию проекта у производителя компонентов.
- Техническую поддержку проекта.
- Защиту от снятия компонента с производства.
- Оценку стоимости проекта по компонентам.
- Изготовление тестовой платы монтаж и пусконаладочные работы.



Тел: +7 (812) 336 43 04 (многоканальный)

Email: [org@lifeelectronics.ru](mailto:org@lifeelectronics.ru)