

General Description

The MIC2287 is a 1.2MHz pulse width modulated (PWM), boost-switching regulator that is optimized for constant-current, white LED driver applications. With a maximum output voltage of 34V and a switch current of over 500mA, the MIC2287 easily drives a string of up to 8 white LEDs in series, ensuring uniform brightness and eliminating several ballast resistors.

The MIC2287 implements a constant frequency, 1.2MHz PWM control scheme. The high frequency PWM operation saves board space by reducing external component sizes. The added benefit of the constant frequency PWM scheme as opposed to variable frequency topologies is much lower noise and input ripple injected back to the battery source.

To optimize efficiency, the feedback voltage is set to only 95mV. This reduces the power dissipation in the current set resistor and allows the lowest total output voltage, hence minimal current draw from the battery.

The MIC2287 is available with 3 levels of overvoltage protection, 15V, 24V, and 34V. This allows designers to choose the smallest possible external components with the appropriate voltage ratings for their applications.

The MIC2287 is available in low profile Thin SOT-235-lead and an 8-lead 2mm × 2mm MLF™ package options. The MIC2287 has a junction temperature range of -40°C to +125°C.

All support documentation can be found on Micrel's web site at www.micrel.com.

Features

- 2.5V to 10V input voltage
- Output voltage up to 34V
- Over 500mA switch current
- 1.2 MHz PWM operation
- 95mV feedback voltage
- Output Overvoltage Protection (OVP)
- Options for 15V, 24V, and 34V OVP
- <1% line and load regulation
- <1µA shutdown current
- Over-temperature protection
- UVLO
- Low profile Thin SOT-23-5 package option
- 8-lead 2mm × 2mm MLF™ package option
- -40°C to +125°C junction temperature range

Applications

- White LED driver for backlighting:
 - Cell phones
 - PDAs
 - GPS systems
 - Digital cameras
 - MP3 players
 - IP phones
- Photo flash LED driver
- LED flashlights
- Constant current power supplies

Typical Application



3-Series White LED Driver in Thin SOT-23

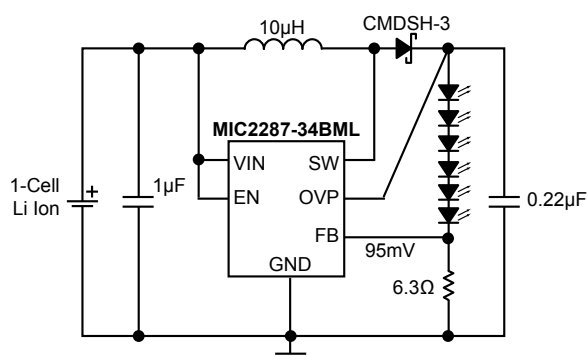

6-Series White LED Driver with Output OVP in 2mm × 2mm MLF™-8

Ordering Information

Part Number	Marking Code	Overvoltage Protection	Junction Temp. Range	Package	Lead Finish
MIC2287BD5	SGAA	N/A	-40°C to 125°C	Thin SOT-23-5	Standard
MIC2287YD5	SGAA	N/A	-40°C to 125°C	Thin SOT-23-5	Lead Free
MIC2287-15BML	SLA	15V	-40°C to 125°C	2mm x 2mm MLF™	Standard
MIC2287-15YML	SLA	15V	-40°C to 125°C	2mm x 2mm MLF™	Lead Free
MIC2287-24BML	SLB	24V	-40°C to 125°C	2mm x 2mm MLF™	Standard
MIC2287-24YML	SLB	24V	-40°C to 125°C	2mm x 2mm MLF™	Lead Free
MIC2287-34BML	SLC	34V	-40°C to 125°C	2mm x 2mm MLF™	Standard
MIC2287-34YML	SLC	34V	-40°C to 125°C	2mm x 2mm MLF™	Lead Free

Pin Configuration



TSOT-23-5 (BD5)



8-Pin MLF™ (BML)
(Top View)

Fused Lead Frame

Pin Description

Pin Number TSOT-23-5	Pin Number 2mm x 2mm MLF™	Pin Name	Pin Function
1	7	SW	Switch node (Input): Internal power BIPOLAR collector.
2		GND	Ground (Return): Ground.
3	6	FB	Feedback (Input): Output voltage sense node. Connect the cathode of the LED to this pin. A resistor from this pin to ground sets the LED current.
4	3	EN	Enable (Input): Logic high enables regulator. Logic low shuts down regulator.
5	2	VIN	Supply (Input): 2.5V to 10V for internal circuitry.
—	1	OVP	Overvoltage protection (Input): Connect to the output.
—	4	AGND	Analog ground.
—	8	PGND	Power ground.
—	5	NC	No connect (no internal connection to die).
—	EP	GND	Ground (Return): Exposed backside pad.

Absolute Maximum Ratings⁽¹⁾

Supply Voltage (V_{IN})	12V
Switch Voltage (V_{SW})	-0.3V to 34V
Enable Pin Voltage (V_{EN})	-0.3 to V_{IN}
FB Voltage (V_{FB})	6V
Switch Current (I_{SW})	2A
Ambient Storage Temperature (T_S)	-65°C to +150°C
ESD Rating ⁽³⁾	2kV

Operating Ratings⁽²⁾

Supply Voltage (V_{IN})	2.5V to 10V
Junction Temperature Range (T_J)	-40°C to +125°C
Package Thermal Impedance	
2mm × 2mmMLF™ (θ_{JA})	93°C/W
Thin SOT-23-5 (θ_{JA})	256°C/W

Electrical Characteristics⁽⁴⁾

$T_A = 25^\circ\text{C}$, $V_{IN} = V_{EN} = 3.6\text{V}$, $V_{OUT} = 10\text{V}$, $I_{OUT} = 10\text{mA}$, unless otherwise noted. **Bold** values indicate $-40^\circ\text{C} \leq T_J \leq 125^\circ\text{C}$.

Symbol	Parameter	Condition	Min	Typ	Max	Units
V_{IN}	Supply Voltage Range		2.5		10	V
V_{UVLO}	Under Voltage Lockout		1.8	2.1	2.4	V
I_{VIN}	Quiescent Current	$V_{FB} > 200\text{mV}$, (not switching)		2.5	5	mA
I_{SD}	Shutdown Current	$V_{EN} = 0\text{V}^{(5)}$		0.1	1	μA
V_{FB}	Feedback Voltage	($\pm 5\%$)	90	95	100	mV
I_{FB}	Feedback Input Current	$V_{FB} = 95\text{mV}$		-450		nA
	Line Regulation ⁽⁶⁾	$3\text{V} \leq V_{IN} \leq 5\text{V}$		0.5	1	%
	Load Regulation ⁽⁶⁾	$5\text{mA} \leq I_{OUT} \leq 20\text{mA}$		0.5	2	%
D_{MAX}	Maximum Duty Cycle		85	90		%
I_{SW}	Switch Current Limit			750		mA
V_{SW}	Switch Saturation Voltage	$I_{SW} = 0.5\text{A}$		450		mV
I_{SW}	Switch Leakage Current	$V_{EN} = 0\text{V}$, $V_{SW} = 10\text{V}$		0.01	5	μA
V_{EN}	Enable Threshold	TURN ON TURN OFF	1.5		0.4	V V
I_{EN}	Enable Pin Current	$V_{EN} = 10\text{V}$		20	40	μA
f_{SW}	Oscillator Frequency		1.05	1.2	1.35	MHz
V_{OVP}	Overvoltage Protection	MIC2287BML- 15 only MIC2287BML- 24 only MIC2287BML- 34 only	13 21 30	14 22.5 32	16 24 34	V V V
T_J	Overtemperature Threshold Shutdown	Hysteresis		150 10		$^\circ\text{C}$ $^\circ\text{C}$

Notes:

1. Absolute maximum ratings indicate limits beyond which damage to the component may occur. Electrical specifications do not apply when operating the device outside of its operating ratings. The maximum allowable power dissipation is a function of the maximum junction temperature, $T_J(\text{max})$, the junction-to-ambient thermal resistance, θ_{JA} , and the ambient temperature, T_A . The maximum allowable power dissipation will result in excessive die temperature, and the regulator will go into thermal shutdown.
2. This device is not guaranteed to operate beyond its specified operating ratings.
3. Devices are inherently ESD sensitive. Handling precautions required. Human body model.
4. Specification for packaged product only.
5. $I_{SD} = I_{VIN}$.
6. Guaranteed by design.

Typical Characteristics

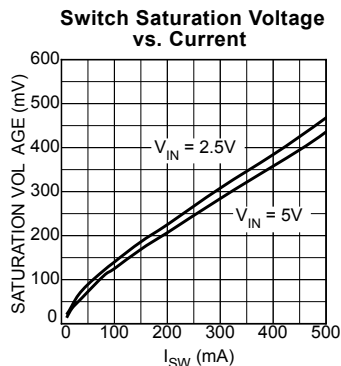
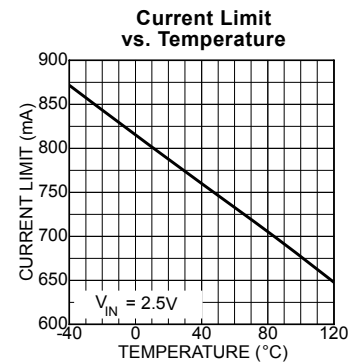
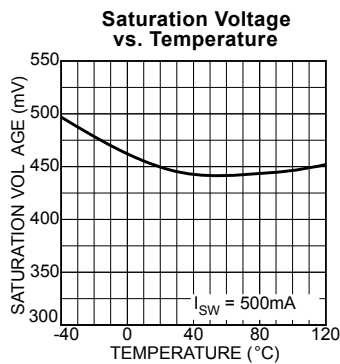
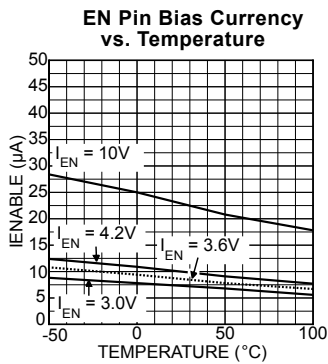
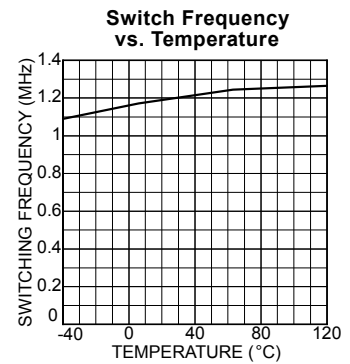
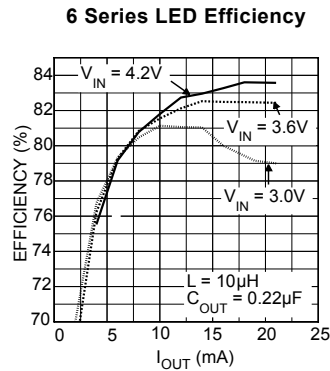
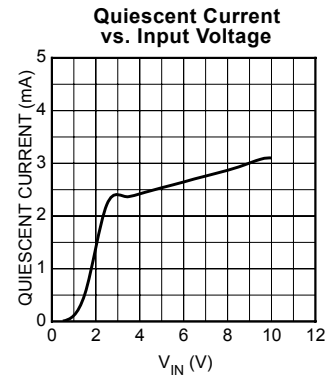

Functional Diagram



*OVP available on MLF™ package option only

MIC2287 Block Diagram

Functional Description

The MIC2287 is a constant frequency, PWM current mode boost regulator. The block diagram is shown above. The MIC2287 is composed of an oscillator, slope compensation ramp generator, current amplifier, g_m error amplifier, PWM generator, and a 500mA bipolar output transistor. The oscillator generates a 1.2MHz clock. The clock's two functions are to trigger the PWM generator that turns on the output transistor and to reset the slope compensation ramp generator. The current amplifier is used to measure the switch current by amplifying the voltage signal from the internal sense resistor. The output of the current amplifier is summed with the output of the slope compensation ramp generator. This summed current-loop signal is fed to one of the inputs of the PWM generator.

The g_m error amplifier measures the LED current through the external sense resistor and amplifies the error between the detected signal and the 95mV reference voltage. The output of the g_m error amplifier provides the voltage-loop signal that is fed to the other input of the PWM generator. When the current-loop signal exceeds the voltage-loop signal, the PWM generator turns off the bipolar output transistor. The next clock period initiates the next switching cycle, maintaining the constant frequency current-mode PWM control. The LED is set by the feedback resistor:

$$I_{LED} = \frac{95\text{mV}}{R_{FB}}$$

The Enable pin shuts down the output switching and disables the control circuitry to reduce input current-to-leakage levels. Enable pin input current is zero at zero volts.

External Component Selection

The MIC2287 can be used across a wide range of applications.

The table below shows recommended inductor and output capacitor values for various series-LED applications.

Series LEDs	L	Manufacturer	Min C _{OUT}	Manufacturer
2	22μH	LQH32CN220K21 (Murata) NLC453232T-220K(TDK)	2.2μF	0805ZD225KAT(AVX) GRM40X5R225K10(Murata)
	15μH	LQH32CN150K21 (Murata) NLC453232T-150K(TDK)	1μF	0805ZD105KAT(AVX) GRM40X5R105K10(Murata)
	10μH	LQH32CN100K21 (Murata) NLC453232T-100K(TDK)	0.22μF	0805ZD224KAT(AVX) GRM40X5R224K10(Murata)
	6.8μH	LQH32CN6R8K21 (Murata) NLC453232T-6R8K(TDK)	0.22μF	0805ZD225KAT(AVX) GRM40X5R225K10(Murata)
	4.7μH	LQH32CN4R7K21 (Murata) NLC453232T-4R7K(TDK)	0.22μF	0805ZD224KAT(AVX) GRM40X5R224K10(Murata)
3	22μH	LQH43MN220K21 (Murata) NLC453232T-220K(TDK)	2.2μF	0805YD225MAT(AVX) GRM40X5R225K16(Murata)
	15μH	LQH43MN 150K21 (Murata) NLC453232T-150K(TDK)	1μF	0805YD105MAT(AVX) GRM40X5R105K16(Murata)
	10μH	LQH43MN 100K21 (Murata) NLC453232T-100K(TDK)	0.22μF	0805YD224MAT(AVX) GRM40X5R224K16(Murata)
	6.8μH	LQH43MN 6R8K21 (Murata) NLC453232T-6R8K(TDK)	0.22μF	0805YD224MAT(AVX) GRM40X5R224K16(Murata)
	4.7μH	LQH43MN 4R7K21 (Murata) NLC453232T-4R7K(TDK)	0.27μF	0805YD274MAT(AVX) GRM40X5R224K16(Murata)
4	22μH	LQH43MN220K21 (Murata) NLC453232T-220K(TDK)	1μF	0805YD105MAT(AVX) GRM40X5R105K25(Murata)
	15μH	LQH43MN 150K21 (Murata) NLC453232T-150K(TDK)	1μF	0805YD105MAT(AVX) GRM40X5R105K25(Murata)
	10μH	LQH43MN 100K21 (Murata) NLC453232T-100K(TDK)	0.27μF	0805YD274MAT(AVX) GRM40X5R274K25(Murata)
	6.8μH	LQH43MN 6R8K21 (Murata) NLC453232T-6R8K(TDK)	0.27μF	0805YD274MAT(AVX) GRM40X5R274K25(Murata)
	4.7μH	LQH43MN 4R7K21 (Murata) NLC453232T-4R7K(TDK)	0.27μF	0805YD274MAT(AVX) GRM40X5R274K25(Murata)
5, 6	22μH	LQH43MN220K21 (Murata) NLC453232T-220K(TDK)	0.22μF	08053D224MAT(AVX) GRM40X5R224K25(Murata)
	15μH	LQH43MN 150K21 (Murata) NLC453232T-150K(TDK)	0.22μF	08053D224MAT(AVX) GRM40X5R224K25(Murata)
	10μH	LQH43MN 100K21 (Murata) NLC453232T-100K(TDK)	0.27μF	08053D274MAT(AVX) GRM40X5R274K25(Murata)
	6.8μH	LQH43MN 6R8K21 (Murata) NLC453232T-6R8K(TDK)	0.27μF	08053D274MAT(AVX) GRM40X5R274K25(Murata)
	4.7μH	LQH43MN 4R7K21 (Murata) NLC453232T-4R7K(TDK)	0.27μF	08053D274MAT(AVX) GRM40X5R274K25(Murata)
7, 8	22μH	LQH43MN220K21 (Murata) NLC453232T-220K(TDK)	0.22μF	08053D224MAT(AVX) GRM40X5R224K25(Murata)
	15μH	LQH43MN 150K21 (Murata) NLC453232T-150K(TDK)	0.22μF	08053D224MAT(AVX) GRM40X5R224K25(Murata)
	10μH	LQH43MN 100K21 (Murata) NLC453232T-100K(TDK)	0.27μF	08053D274MAT(AVX) GRM40X5R274K25(Murata)
	6.8μH	LQH43MN 6R8K21 (Murata) NLC453232T-6R8K(TDK)	0.27μF	08053D274MAT(AVX) GRM40X5R274K25(Murata)
	4.7μH	LQH43MN 4R7K21 (Murata) NLC453232T-4R7K(TDK)	0.27μF	08053D274MAT(AVX) GRM40X5R274K25(Murata)

Dimming Control

There are two techniques for dimming control. One is PWM dimming, and the other is continuous dimming.

1. PWM dimming control is implemented by applying a PWM signal on EN pin as shown in Figure 1. The MIC2287 is turned on and off by the PWM signal. With this method, the LEDs operate with either zero or full current. The average LED current is increased proportionally to the duty-cycle of the PWM signal. This technique has high-efficiency because the IC and the LEDs consume no current during the off cycle of the PWM signal. Typical PWM frequency should be between 100Hz and 10kHz.
2. Continuous dimming control is implemented by applying a DC control voltage to the FB pin of the MIC2287 through a series resistor as shown in Figure 2. The LED intensity (current) can be dynamically varied applying a DC voltage to the FB pin. The DC voltage can come from a DAC signal, or a filtered PWM signal. The advantage of this approach is a high frequency PWM signal (>10kHz) that can be used to control LED intensity.

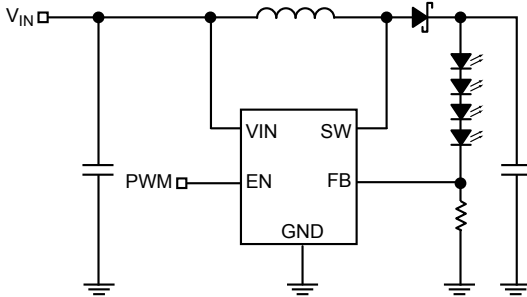

Figure 1. PWM Dimming Method



Figure 2. Continuous Dimming

Open-Circuit Protection

If the LEDs are disconnected from the circuit, or in case an LED fails open, the sense resistor will pull the FB pin to ground. This will cause the MIC2287 to switch with a high duty-cycle, resulting in output overvoltage. This may cause the SW pin voltage to exceed its maximum voltage rating, possibly damaging the IC and the external components. To ensure the highest level of protection, the MIC2287 has 3 product options in the 8-lead 2mm × 2mm MLF™ with over-voltage protection (OVP). The extra pins of the 8-lead 2mm × 2mm MLF™ package allow a dedicated OVP monitor with

options for 15V, 24V, or 34V (see Figure 3). The reason for the three OVP levels is to let users choose the suitable level of OVP for their application. For example, a 3-LED application would typically see an output voltage of no more than 12V, so a 15V OVP option would offer a suitable level of protection. This allows the user to select the output diode and capacitor with the lowest voltage ratings, as well as smallest size and lowest cost. The OVP will clamp the output voltage to within the specified limits. For the Thin SOT-23-5 package, an OVP pin is not available. An external zener diode can be connected from the output of the converter to FB pin as shown in Figure 4. to implement similar protection.



Figure 3. MLF™ Package OVP Circuit

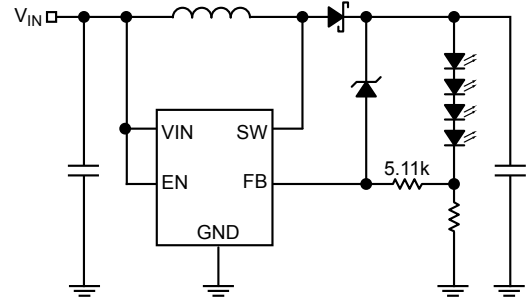

Figure 4. Thin SOT-23 Package OVP Circuit

Start-Up and Inrush Current

During start-up, inrush current of approximately double the nominal current flows to set up the inductor current and the voltage on the output capacitor. If the inrush current needs to be limited, a soft-start circuit similar to Figure 5 could be implemented. The soft-start capacitor, C_{SS}, provides overdrive to the FB pin at start-up, resulting in gradual increase of switch duty cycle and limited inrush current.

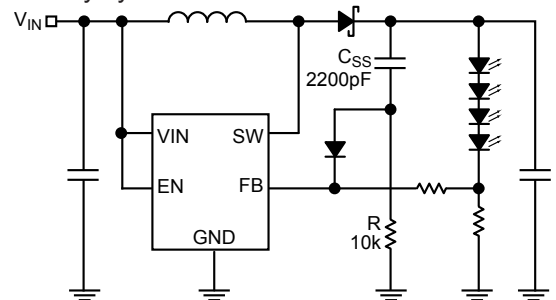
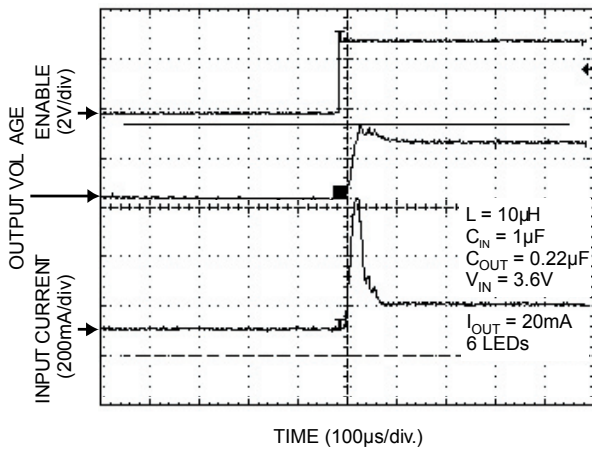
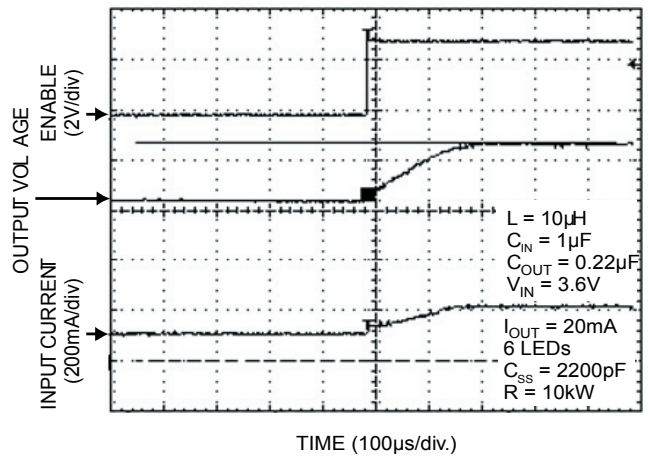

Figure 5. Soft-Start Circuit

6-Series LED Circuit without External Soft-Start



6-Series LED Circuit with External Soft-Start



Package Information



NOTE:

1. Dimensions and tolerances are as per ANSI Y14.5M, 1994.
2. Die is facing up for mold. Die is facing down for trim/form, ie. reverse trim/form.
3. Dimensions are exclusive of mold flash and gate burr.
4. The footlength measuring is based on the gauge plane method.
5. All specification comply to Jedec Spec M0193 Issue C.
6. All dimensions are in millimeters.



5-Pin TSOT (BD5)

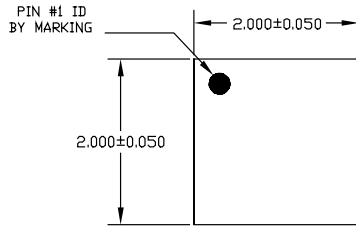

TOP VIEW

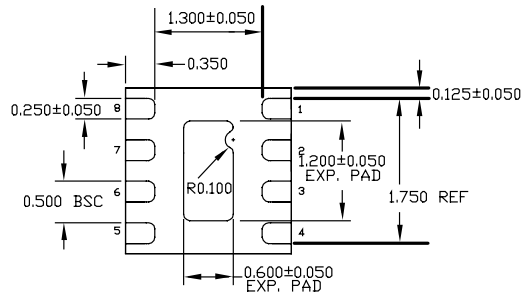

BOTTOM VIEW

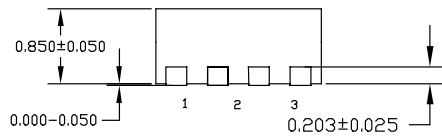

SIDE VIEW

NOTE:

1. ALL DIMENSIONS ARE IN MILLIMETERS.
2. MAX. PACKAGE WARPAGE IS 0.05 mm.
3. MAXIMUM ALLOWABLE BURRS IS 0.076 mm IN ALL DIRECTIONS.
4. PIN #1 ID ON TOP WILL BE LASER/INK MARKED.

8-Pin MLF™ (BML)

Recommended Land Pattern for MLF™ 2×2 8 Lead

MICREL INC. 2180 FORTUNE DRIVE SAN JOSE, CA 95131 USA

TEL + 1 (408) 944-0800 FAX + 1 (408) 474-1000 WEB <http://www.micrel.com>

This information furnished by Micrel in this data sheet is believed to be accurate and reliable. However no responsibility is assumed by Micrel for its use.

Micrel reserves the right to change circuitry and specifications at any time without notification to the customer.

Micrel Products are not designed or authorized for use as components in life support appliances, devices or systems where malfunction of a product can reasonably be expected to result in personal injury. Life support devices or systems are devices or systems that (a) are intended for surgical implant into the body or (b) support or sustain life, and whose failure to perform can be reasonably expected to result in a significant injury to the user. A Purchaser's use or sale of Micrel Products for use in life support appliances, devices or systems is a Purchaser's own risk and Purchaser agrees to fully indemnify

Micrel for any damages resulting from such use or sale.

© 2004 Micrel, Inc.

Компания «Life Electronics» занимается поставками электронных компонентов импортного и отечественного производства от производителей и со складов крупных дистрибьюторов Европы, Америки и Азии.

С конца 2013 года компания активно расширяет линейку поставок компонентов по направлению коаксиальный кабель, кварцевые генераторы и конденсаторы (керамические, пленочные, электролитические), за счёт заключения дистрибьюторских договоров

Мы предлагаем:

- Конкуренспособные цены и скидки постоянным клиентам.
- Специальные условия для постоянных клиентов.
- Подбор аналогов.
- Поставку компонентов в любых объемах, удовлетворяющих вашим потребностям.
- Приемлемые сроки поставки, возможна ускоренная поставка.
- Доставку товара в любую точку России и стран СНГ.
- Комплексную поставку.
- Работу по проектам и поставку образцов.
- Формирование склада под заказчика.
- Сертификаты соответствия на поставляемую продукцию (по желанию клиента).
- Тестирование поставляемой продукции.
- Поставку компонентов, требующих военную и космическую приемку.
- Входной контроль качества.
- Наличие сертификата ISO.

В составе нашей компании организован Конструкторский отдел, призванный помогать разработчикам, и инженерам.

Конструкторский отдел помогает осуществить:

- Регистрацию проекта у производителя компонентов.
- Техническую поддержку проекта.
- Защиту от снятия компонента с производства.
- Оценку стоимости проекта по компонентам.
- Изготовление тестовой платы монтаж и пусконаладочные работы.



Тел: +7 (812) 336 43 04 (многоканальный)

Email: org@lifeelectronics.ru

www.lifeelectronics.ru