

Low voltage fast-switching NPN power transistor

Features

- Very low collector to emitter saturation voltage
- High current gain characteristic
- Fast-switching speed

Applications

- Emergency lighting
- Voltage regulators
- Relay drivers
- High efficiency low voltage switching applications

Description

The device is manufactured in Planar Technology with "Base Island" layout. The resulting transistor shows exceptional high gain performance coupled with very low saturation voltage.

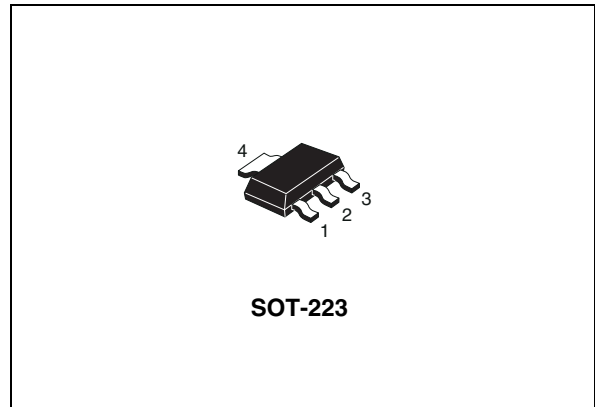

Figure 1. Internal schematic diagram

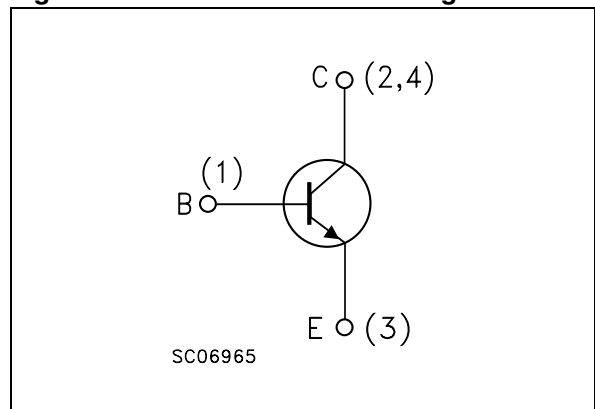

Table 1. Device summary

Order code	Marking	Package	Packaging
STN851	N851	SOT-223	Tape and reel

1 Electrical ratings

Table 2. Absolute maximum ratings

Symbol	Parameter	Value	Unit
V_{CBO}	Collector-base voltage ($I_E = 0$)	150	V
V_{CEO}	Collector-emitter voltage ($I_B = 0$)	60	V
V_{EBO}	Emitter-base voltage ($I_C = 0$)	7	V
I_C	Collector current	5	A
I_{CM}	Collector peak current ($t_P < 5$ ms)	10	A
I_B	Base current	1	A
I_{BM}	Base peak current ($t_P < 5$ ms)	2	A
P_{tot}	Total dissipation at $T_{amb} = 25$ °C	1.6	W
T_{stg}	Storage temperature	-65 to 150	°C
T_J	Max. operating junction temperature	150	°C

Table 3. Thermal data

Symbol	Parameter	Value	Unit
$R_{thj-amb}$	Thermal resistance junction-ambient ⁽¹⁾	78	°C/W

1. Device mounted on a p.c.b. area of 1 cm²

2 Electrical characteristics

($T_{\text{case}} = 25\text{ °C}$ unless otherwise specified)

Table 4. Electrical characteristics

Symbol	Parameter	Test conditions	Min.	Typ.	Max.	Unit
I_{CBO}	Collector cut-off current ($I_{\text{E}} = 0$)	$V_{\text{CB}} = 120\text{ V}$ $V_{\text{CB}} = 120\text{ V } T_{\text{C}} = 100\text{ °C}$			50 1	nA μA
I_{EBO}	Emitter cut-off current ($I_{\text{C}} = 0$)	$V_{\text{EB}} = 7\text{ V}$			10	nA
$V_{(\text{BR})\text{CBO}}$	Collector-base breakdown voltage ($I_{\text{E}} = 0$)	$I_{\text{C}} = 100\text{ }\mu\text{A}$	150			V
$V_{(\text{BR})\text{CEO}}^{(1)}$	Collector-emitter breakdown voltage ($I_{\text{B}} = 0$)	$I_{\text{C}} = 10\text{ mA}$	60			V
$V_{(\text{BR})\text{EBO}}$	Emitter-base breakdown voltage ($I_{\text{C}} = 0$)	$I_{\text{E}} = 100\text{ }\mu\text{A}$	7			V
$V_{\text{CE}(\text{sat})}^{(1)}$	Collector-emitter saturation voltage	$I_{\text{C}} = 100\text{ mA } I_{\text{B}} = 5\text{ mA}$ $I_{\text{C}} = 1\text{ A } I_{\text{B}} = 50\text{ mA}$ $I_{\text{C}} = 2\text{ A } I_{\text{B}} = 50\text{ mA}$ $I_{\text{C}} = 5\text{ A } I_{\text{B}} = 200\text{ mA}$		10 70 140 320	50 120 250 500	mV mV mV mV
$V_{\text{BE}(\text{sat})}^{(1)}$	Base-emitter saturation voltage	$I_{\text{C}} = 4\text{ A } I_{\text{B}} = 200\text{ mA}$		1	1.15	V
$V_{\text{BE}(\text{on})}^{(1)}$	Base-emitter on voltage	$I_{\text{C}} = 4\text{ A } V_{\text{CE}} = 1\text{ V}$		0.89	1	V
$h_{\text{FE}}^{(1)}$	DC current gain	$I_{\text{C}} = 10\text{ mA } V_{\text{CE}} = 1\text{ V}$ $I_{\text{C}} = 2\text{ A } V_{\text{CE}} = 1\text{ V}$ $I_{\text{C}} = 5\text{ A } V_{\text{CE}} = 1\text{ V}$ $I_{\text{C}} = 10\text{ A } V_{\text{CE}} = 1\text{ V}$	150 150 90 30	300 270 140 50	350	
f_{T}	Transition frequency	$V_{\text{CE}} = 10\text{ V } I_{\text{C}} = 100\text{ mA}$		130		MHz
C_{CBO}	Collector-base capacitance ($I_{\text{E}} = 0$)	$V_{\text{CB}} = 10\text{ V } f = 1\text{ MHz}$		50		pF
t_{on} t_{s} t_{f}	Resistive load Turn-on time Storage time Fall time	$I_{\text{C}} = 1\text{ A } V_{\text{CC}} = 10\text{ V}$ $I_{\text{B1}} = -I_{\text{B2}} = 0.1\text{ A}$		50 1.35 120		ns μs ns

1. Pulse duration = 300 μs , duty cycle $\leq 1.5\%$

2.1 Electrical characteristics (curves)

Figure 2. Derating curve

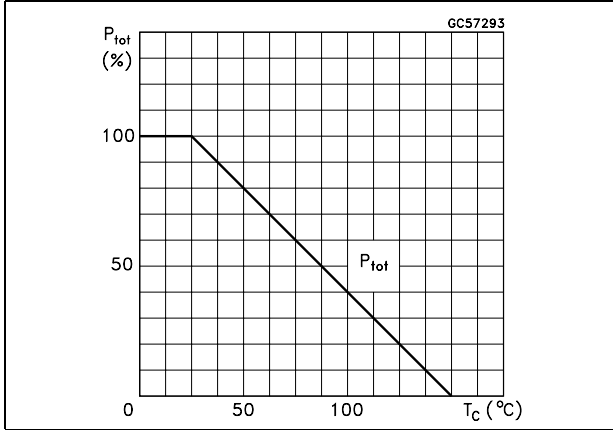

Figure 3. DC current gain

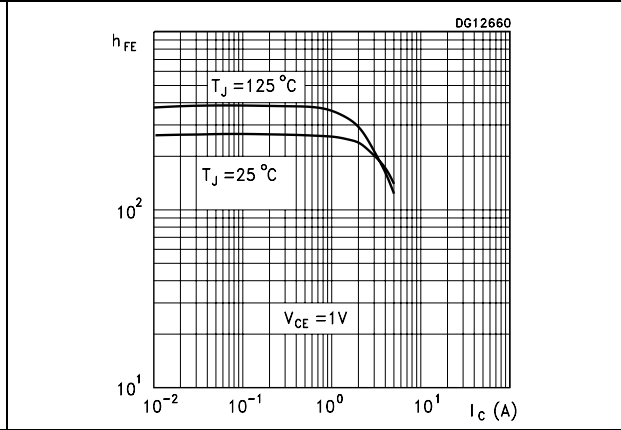

Figure 4. Collector-emitter saturation voltage

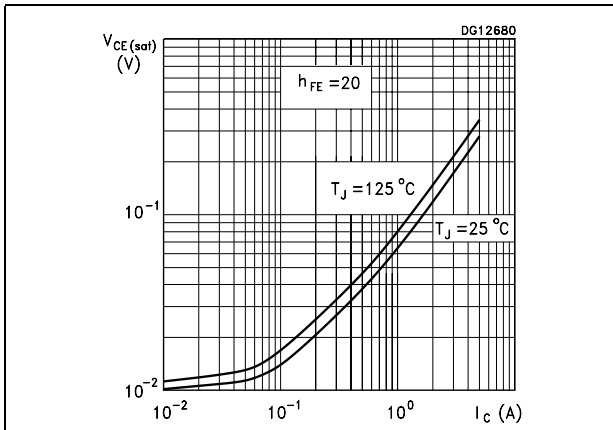

Figure 5. Collector-emitter saturation voltage

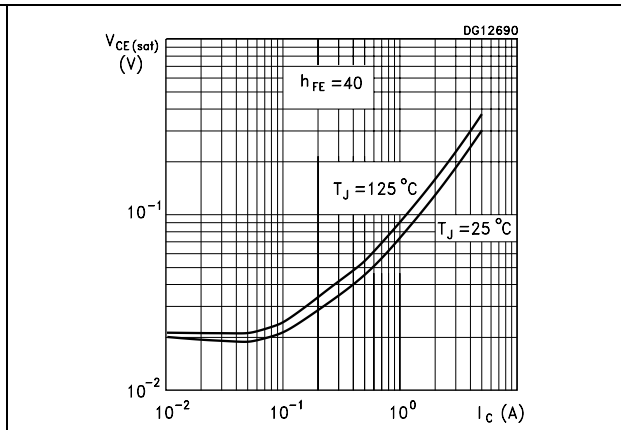

Figure 6. Base-emitter saturation voltage

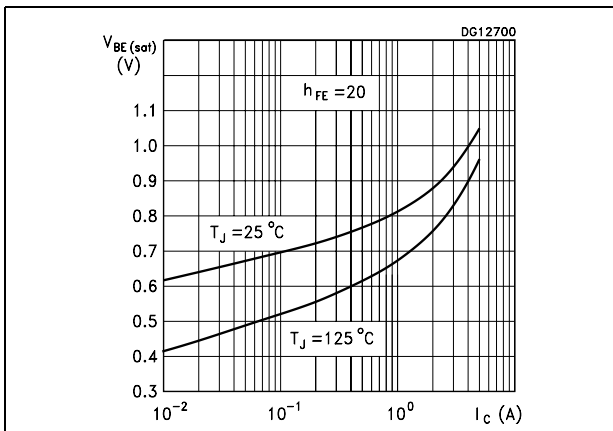

Figure 7. Base-emitter on voltage

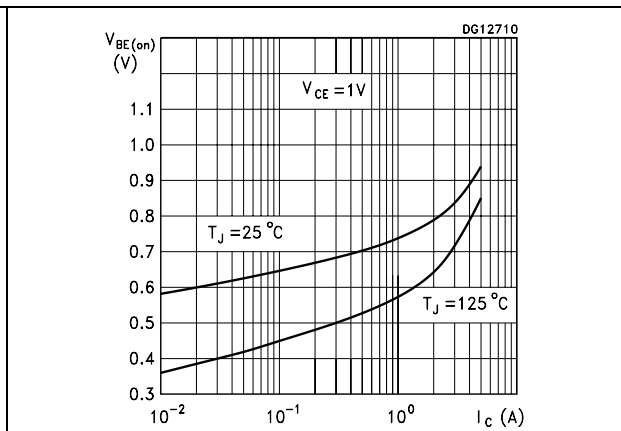

Figure 8. Resistive load switching time

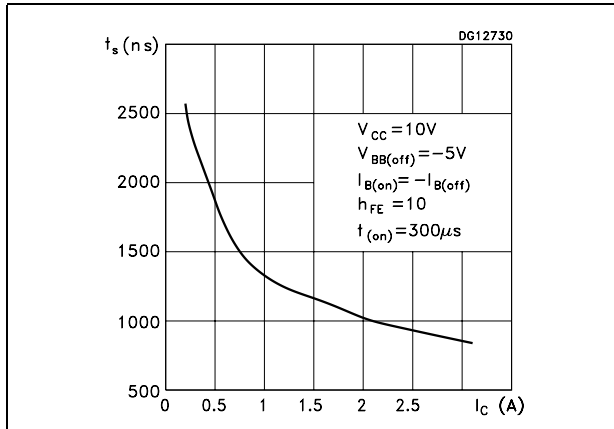

Figure 9. Resistive load switching time

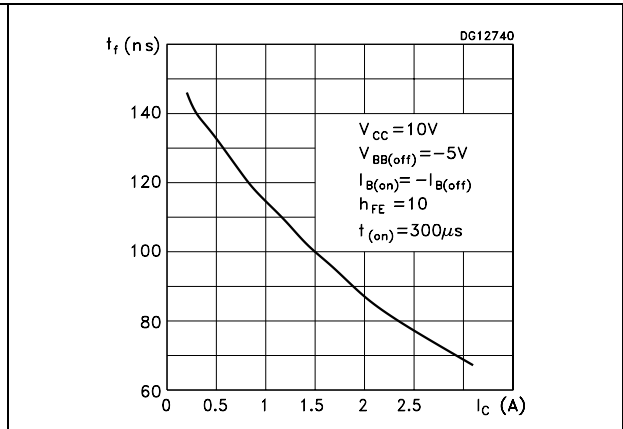

Figure 10. Resistive load switching time

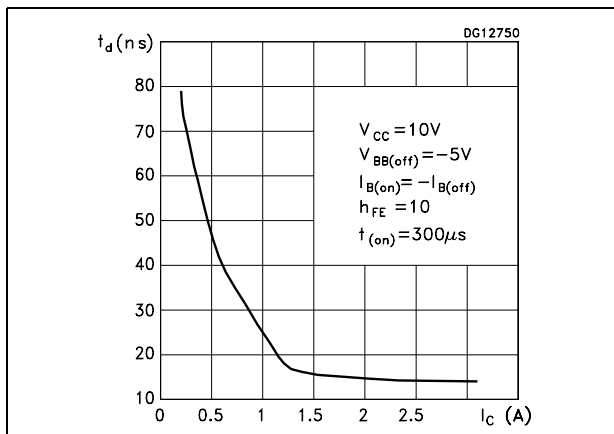

Figure 11. Inductive load switching time

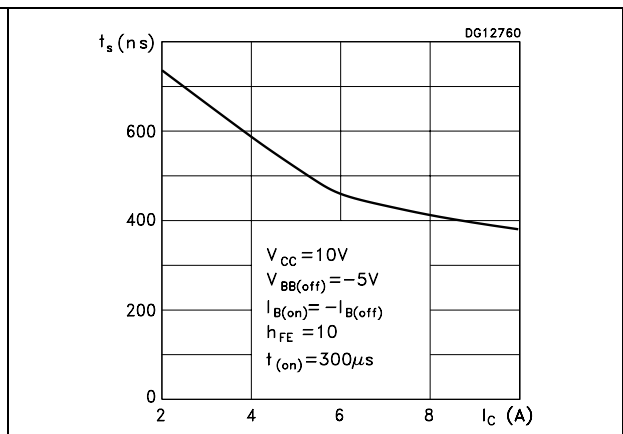
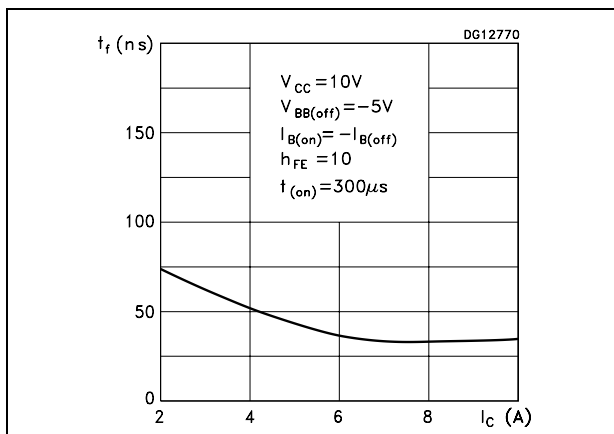
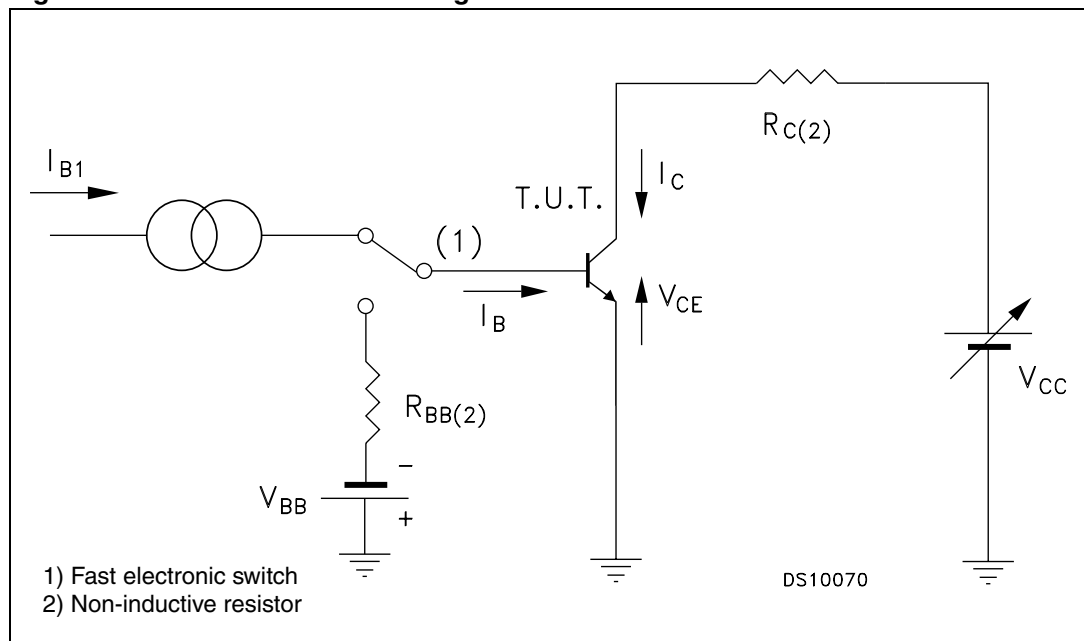

Figure 12. Inductive load switching time



2.2 Test circuit

Figure 13. Resistive load switching test circuit



3 Package mechanical data

In order to meet environmental requirements, ST offers these devices in different grades of ECOPACK® packages, depending on their level of environmental compliance. ECOPACK® specifications, grade definitions and products status are available at: www.st.com. ECOPACK is an ST trademark.

SOT-223 mechanical data

DIM.	mm.		
	min.	typ	max.
A			1.80
A1	0.02		0.1
B	0.60	0.70	0.85
B1	2.90	3.00	3.15
c	0.24	0.26	0.35
D	6.30	6.50	6.70
e		2.30	
e1		4.60	
E	3.30	3.50	3.70
H	6.70	7.00	7.30
V			10 °

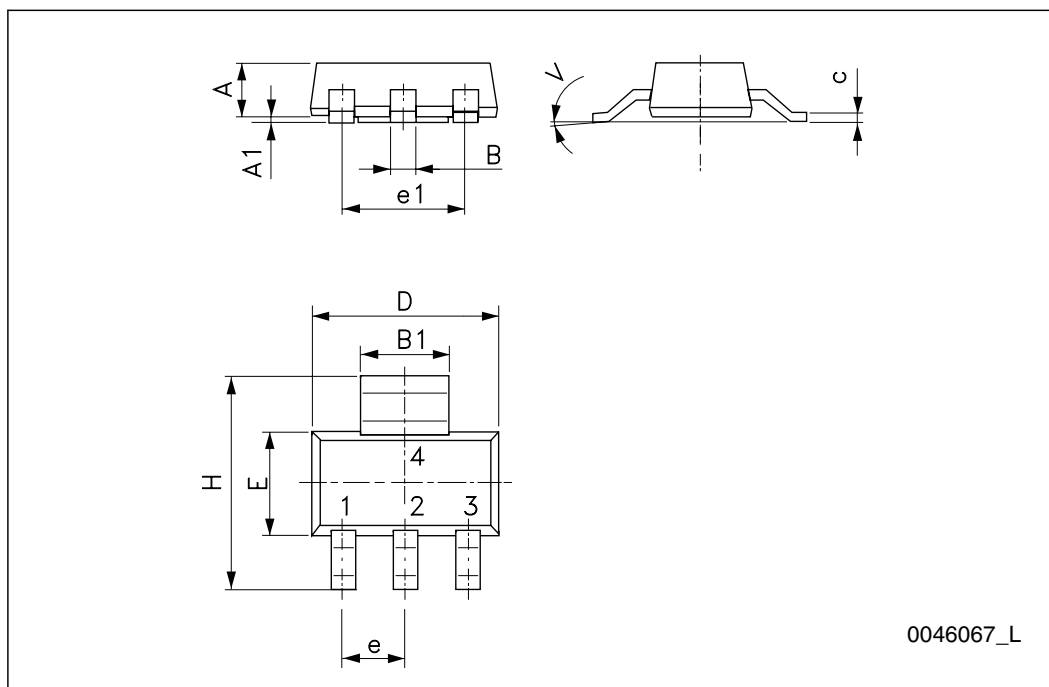

4 Revision history

Table 5. Document revision history

Date	Revision	Changes
09-Sep-2003	6	
16-Mar-2009	7	Updated SOT-223 mechanical data

Please Read Carefully:

Information in this document is provided solely in connection with ST products. STMicroelectronics NV and its subsidiaries ("ST") reserve the right to make changes, corrections, modifications or improvements, to this document, and the products and services described herein at any time, without notice.

All ST products are sold pursuant to ST's terms and conditions of sale.

Purchasers are solely responsible for the choice, selection and use of the ST products and services described herein, and ST assumes no liability whatsoever relating to the choice, selection or use of the ST products and services described herein.

No license, express or implied, by estoppel or otherwise, to any intellectual property rights is granted under this document. If any part of this document refers to any third party products or services it shall not be deemed a license grant by ST for the use of such third party products or services, or any intellectual property contained therein or considered as a warranty covering the use in any manner whatsoever of such third party products or services or any intellectual property contained therein.

UNLESS OTHERWISE SET FORTH IN ST'S TERMS AND CONDITIONS OF SALE ST DISCLAIMS ANY EXPRESS OR IMPLIED WARRANTY WITH RESPECT TO THE USE AND/OR SALE OF ST PRODUCTS INCLUDING WITHOUT LIMITATION IMPLIED WARRANTIES OF MERCHANTABILITY, FITNESS FOR A PARTICULAR PURPOSE (AND THEIR EQUIVALENTS UNDER THE LAWS OF ANY JURISDICTION), OR INFRINGEMENT OF ANY PATENT, COPYRIGHT OR OTHER INTELLECTUAL PROPERTY RIGHT.

UNLESS EXPRESSLY APPROVED IN WRITING BY AN AUTHORIZED REPRESENTATIVE OF ST, ST PRODUCTS ARE NOT RECOMMENDED, AUTHORIZED OR WARRANTED FOR USE IN MILITARY, AIR CRAFT, SPACE, LIFE SAVING, OR LIFE SUSTAINING APPLICATIONS, NOR IN PRODUCTS OR SYSTEMS, WHERE FAILURE OR MALFUNCTION MAY RESULT IN PERSONAL INJURY, DEATH, OR SEVERE PROPERTY OR ENVIRONMENTAL DAMAGE. ST PRODUCTS WHICH ARE NOT SPECIFIED AS "AUTOMOTIVE GRADE" MAY ONLY BE USED IN AUTOMOTIVE APPLICATIONS AT USER'S OWN RISK.

Resale of ST products with provisions different from the statements and/or technical features set forth in this document shall immediately void any warranty granted by ST for the ST product or service described herein and shall not create or extend in any manner whatsoever, any liability of ST.

ST and the ST logo are trademarks or registered trademarks of ST in various countries.

Information in this document supersedes and replaces all information previously supplied.

The ST logo is a registered trademark of STMicroelectronics. All other names are the property of their respective owners.

© 2009 STMicroelectronics - All rights reserved

STMicroelectronics group of companies

Australia - Belgium - Brazil - Canada - China - Czech Republic - Finland - France - Germany - Hong Kong - India - Israel - Italy - Japan - Malaysia - Malta - Morocco - Singapore - Spain - Sweden - Switzerland - United Kingdom - United States of America

www.st.com

Компания «Life Electronics» занимается поставками электронных компонентов импортного и отечественного производства от производителей и со складов крупных дистрибьюторов Европы, Америки и Азии.

С конца 2013 года компания активно расширяет линейку поставок компонентов по направлению коаксиальный кабель, кварцевые генераторы и конденсаторы (керамические, пленочные, электролитические), за счёт заключения дистрибьюторских договоров

Мы предлагаем:

- Конкурентоспособные цены и скидки постоянным клиентам.
- Специальные условия для постоянных клиентов.
- Подбор аналогов.
- Поставку компонентов в любых объемах, удовлетворяющих вашим потребностям.
- Приемлемые сроки поставки, возможна ускоренная поставка.
- Доставку товара в любую точку России и стран СНГ.
- Комплексную поставку.
- Работу по проектам и поставку образцов.
- Формирование склада под заказчика.
- Сертификаты соответствия на поставляемую продукцию (по желанию клиента).
- Тестирование поставляемой продукции.
- Поставку компонентов, требующих военную и космическую приемку.
- Входной контроль качества.
- Наличие сертификата ISO.

В составе нашей компании организован Конструкторский отдел, призванный помогать разработчикам, и инженерам.

Конструкторский отдел помогает осуществить:

- Регистрацию проекта у производителя компонентов.
- Техническую поддержку проекта.
- Защиту от снятия компонента с производства.
- Оценку стоимости проекта по компонентам.
- Изготовление тестовой платы монтаж и пусконаладочные работы.



Тел: +7 (812) 336 43 04 (многоканальный)

Email: org@lifeelectronics.ru