



13 Gbps, 1:4 FANOUT BUFFER w/ PROGRAMMABLE OUTPUT VOLTAGE

Typical Applications

The HMC940LC4B is ideal for:

- RF ATE Applications
- Broadband Test & Measurement
- Serial Data Transmission up to 13 Gbps
- Clock Buffering up to 13 GHz

Features

- Inputs Terminated Internally in 50 Ohms
- Differential Inputs are DC Coupled
- Propagation Delay: 101 ps
- Fast Rise and Fall Times: 26 / 25 ps
- Programmable Differential Output Voltage Swing: 600 - 1400 mV
- Power Dissipation: 440 mW
- 24 Lead Ceramic 4x4 mm SMT Package: 16 mm²

Functional Diagram

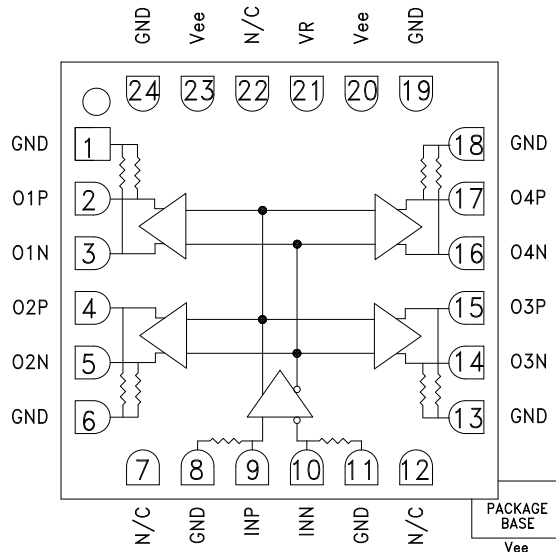

General Description

The HMC940LC4B is a 1:4 Fanout Buffer designed to support data transmission rates up to 13 Gbps, and clock frequencies as high as 13 GHz. All differential inputs and outputs are DC coupled and terminated on chip with 50 Ohm resistors to ground. The outputs may be used in either single-ended or differential modes, and should be AC or DC coupled into 50 Ohm resistors connected to ground.

The HMC940LC4B also features an output level control pin, VR which allows for loss compensation or for signal level optimization. The HMC940LC4B operates from a single -3.3V DC supply and is available in a ceramic RoHS compliant 4x4 mm SMT package.

Electrical Specifications, $T_A = +25\text{ }^\circ\text{C}$, $V_{ee} = -3.3\text{V}$, $VR = 0\text{V}$

Parameter	Conditions	Min.	Typ.	Max	Units
Power Supply Voltage (V _{ee})		-3.6	-3.3	-3.0	V
Power Supply Current			133		mA
Maximum Data Rate			13		Gbps
Maximum Clock Rate			13		GHz
Input High Voltage		-0.5		0.5	V
Input Low Voltage		-1.0		0.0	V
Input Return Loss	Frequency <15 GHz		10		dB
Output Amplitude	Single-Ended, peak-to-peak		585		mVp-p
	Differential, peak-to-peak		1170		mVp-p
Output High Voltage			-15		mV
Output Low Voltage			-600		mV
Output Rise / Fall Time	Single-Ended, 20% - 80%		26 / 25		ps

Information furnished by Analog Devices is believed to be accurate and reliable. However, no responsibility is assumed by Analog Devices for its use, nor for any infringements of patents or other rights of third parties that may result from its use. Specifications subject to change without notice. No license is granted by implication or otherwise under any patent or patent rights of Analog Devices. Trademarks and registered trademarks are the property of their respective owners.

For price, delivery, and to place orders: Analog Devices, Inc., One Technology Way, P.O. Box 9106, Norwood, MA 02062-9106
Phone: 781-329-4700 • Order online at www.analog.com
Application Support: Phone: 1-800-ANALOG-D



**13 Gbps, 1:4 FANOUT BUFFER
w/ PROGRAMMABLE OUTPUT VOLTAGE**

Electrical Specifications (continued)

Parameter	Conditions	Min.	Typ.	Max	Units
Output Return Loss	Frequency <13 GHz		10		dB
Small Signal Gain			20		dB
Random Jitter J_R	rms			0.2	ps rms
Deterministic Jitter, J_D	$\delta - \delta$, 2 ¹⁵ -1 PRBS input [1]		4	6	ps
Propagation Delay, t_d			101		ps
D1 to D2 Data Skew, t_{SKEW}			±3		ps

[1] Deterministic jitter measured at 13 Gbps with a 300 mVp-p, 2¹⁵-1 PRBS input sequence.

DC Current vs. Supply Voltage [1] [2]

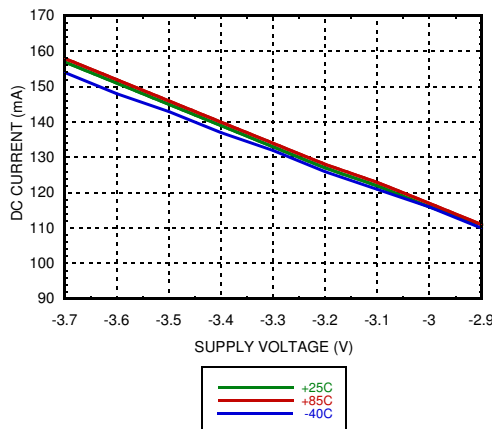

Output Differential vs. Supply Voltage [1] [2]

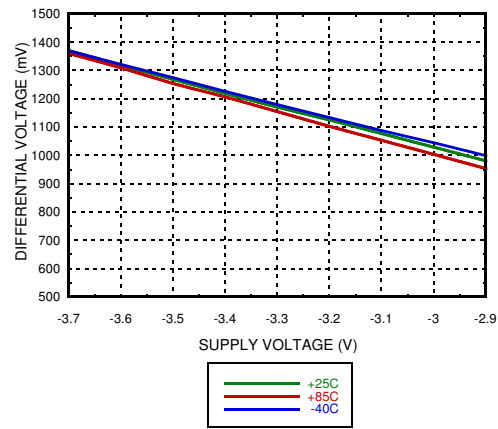

Output Differential vs. VR [2][3]

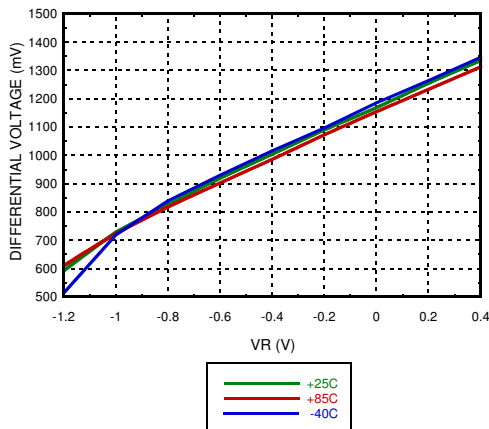

DC Current vs. VR [2][3]

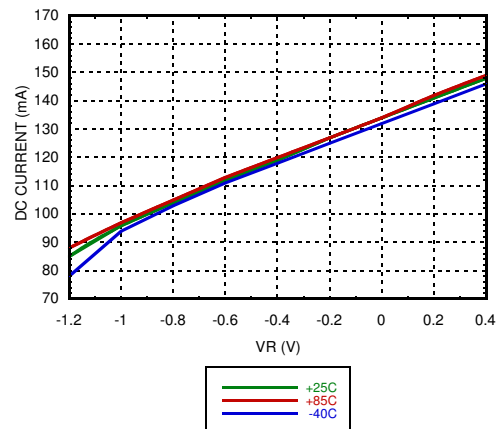

[1] VR = 0.0V

[2] Frequency = 13 GHz

[3] Vee = -3.3V

Information furnished by Analog Devices is believed to be accurate and reliable. However, no responsibility is assumed by Analog Devices for its use, nor for any infringements of patents or other rights of third parties that may result from its use. Specifications subject to change without notice. No license is granted by implication or otherwise under any patent or patent rights of Analog Devices. Trademarks and registered trademarks are the property of their respective owners.

For price, delivery, and to place orders: Analog Devices, Inc., One Technology Way, P.O. Box 9106, Norwood, MA 02062-9106 Phone: 781-329-4700 • Order online at www.analog.com Application Support: Phone: 1-800-ANALOG-D



**13 Gbps, 1:4 FANOUT BUFFER
w/ PROGRAMMABLE OUTPUT VOLTAGE**

Rise / Fall Time vs. Supply Voltage [1][2]

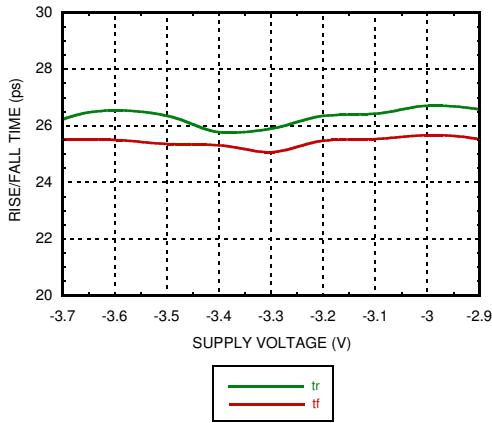

Rise / Fall Time vs. VR [2][5]

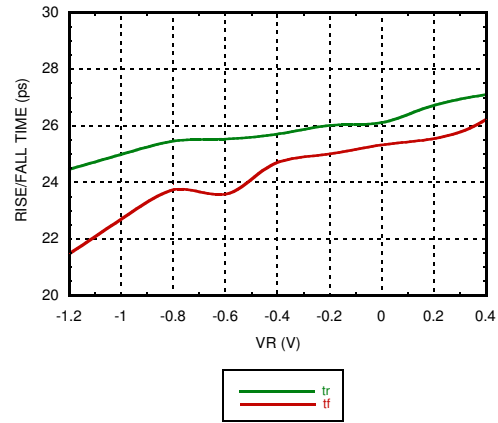

Input Return Loss vs. Frequency [1][3][5]

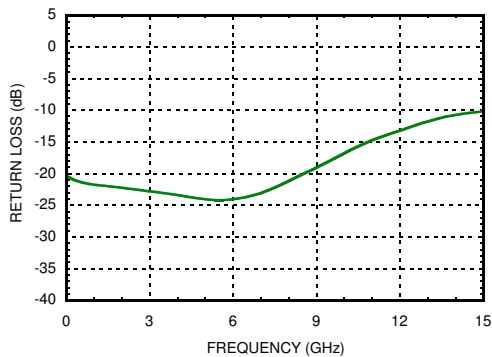

Output Return Loss vs. Frequency [1][3][5]

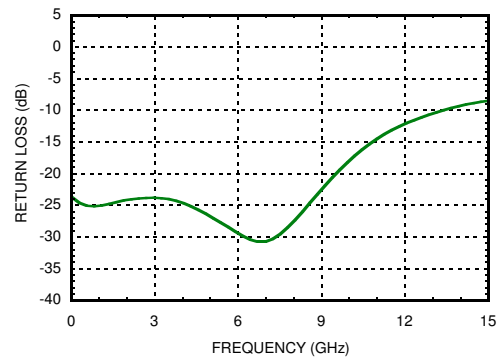

Amplitude vs. Input Power [1][4][5]

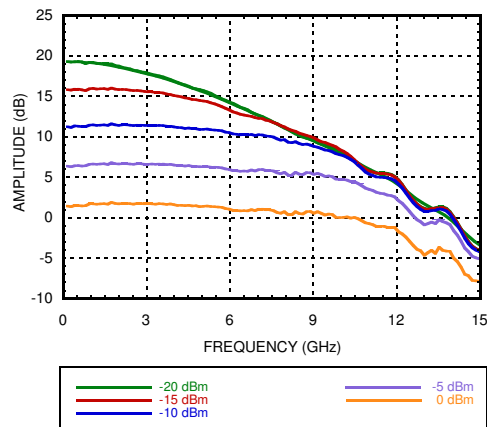

Truth Table

Input	Outputs
IN	Ox
L	L
H	H

Notes:
 IN = INP - INN
 Ox = OxP - OxN

H - Positive differential voltage
 L - Negative differential voltage

[1] VR = 0.0V [2] Frequency = 13 GHz [3] Device measured on evaluation board with gating after connector
 [4] Device measured on evaluation board with port extensions [5] Vee = -3.3V

Information furnished by Analog Devices is believed to be accurate and reliable. However, no responsibility is assumed by Analog Devices for its use, nor for any infringements of patents or other rights of third parties that may result from its use. Specifications subject to change without notice. No license is granted by implication or otherwise under any patent or patent rights of Analog Devices. Trademarks and registered trademarks are the property of their respective owners.

For price, delivery, and to place orders: Analog Devices, Inc., One Technology Way, P.O. Box 9106, Norwood, MA 02062-9106
 Phone: 781-329-4700 • Order online at www.analog.com
 Application Support: Phone: 1-800-ANALOG-D



**13 Gbps, 1:4 FANOUT BUFFER
w/ PROGRAMMABLE OUTPUT VOLTAGE**

Eye Diagram

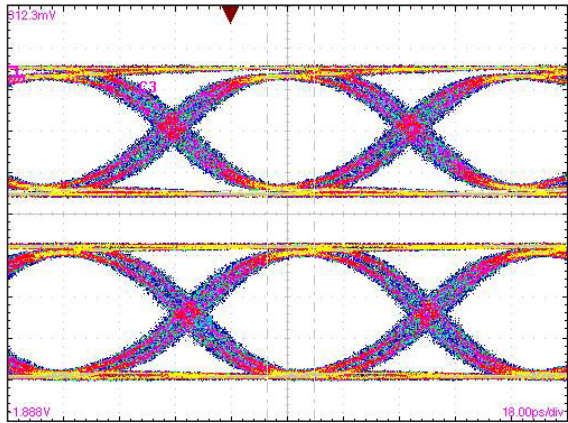

[1] Test Conditions:
 Pattern generated with an Agilent N4903A Serial BERT.
 Eye Diagram presented on a Tektronix CSA 8000.
 Device input = 13 Gbps PN code, $V_{in} = 300$ mVp-p differential.
 Both output channels shown.

Eye Diagram

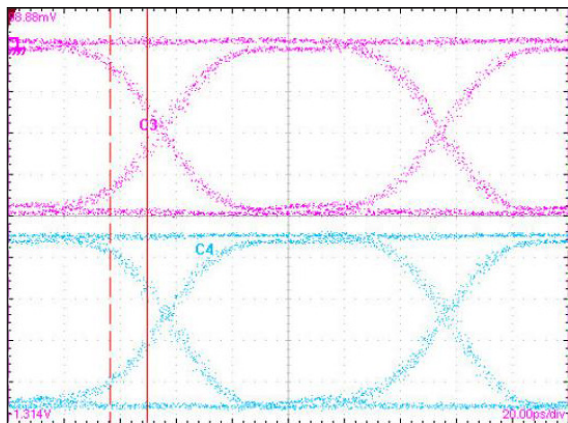

[2] Test Conditions:
 Pattern generated with an Agilent N4903A Serial BERT.
 Eye Diagram presented on a Tektronix CSA 8000.
 Device input = 10 Gbps PN code, $V_{in} = 300$ mVp-p differential.
 Both output channels shown.

Timing Diagram

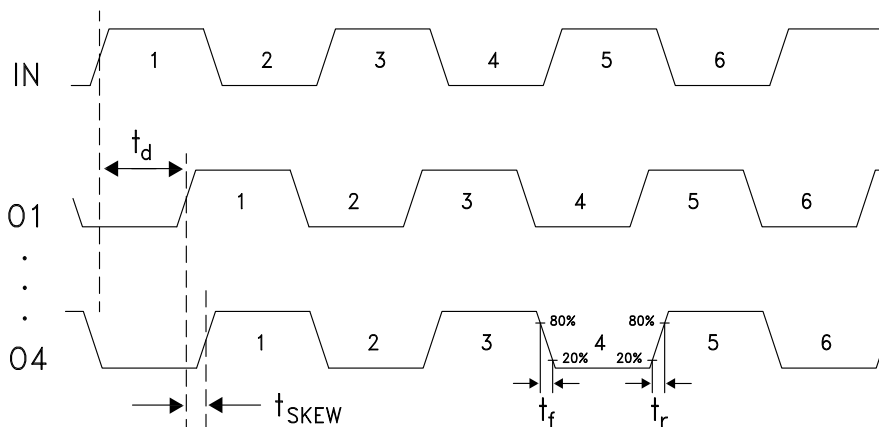

Information furnished by Analog Devices is believed to be accurate and reliable. However, no responsibility is assumed by Analog Devices for its use, nor for any infringements of patents or other rights of third parties that may result from its use. Specifications subject to change without notice. No license is granted by implication or otherwise under any patent or patent rights of Analog Devices. Trademarks and registered trademarks are the property of their respective owners.

For price, delivery, and to place orders: Analog Devices, Inc., One Technology Way, P.O. Box 9106, Norwood, MA 02062-9106
 Phone: 781-329-4700 • Order online at www.analog.com
 Application Support: Phone: 1-800-ANALOG-D



13 Gbps, 1:4 FANOUT BUFFER w/ PROGRAMMABLE OUTPUT VOLTAGE

Absolute Maximum Ratings

Power Supply Voltage (Vee)	-3.75 V to +0.5 V
Input Signals	-2 V to +0.5 V
Output Signals	-1.5 V to +1 V
Junction Temperature	125 °C
Continuous Pdiss (T=85 °C) (derate 30 mW/°C above 85 °C)	1.22 W
Thermal Resistance (R _{th j-p}) Worse case junction to package paddle	32.8 °C/W
Storage Temperature	-65 °C to +150 °C
Operating Temperature	-40 °C to +85 °C
ESD Sensitivity (HBM)	Class 1C



ELECTROSTATIC SENSITIVE DEVICE
OBSERVE HANDLING PRECAUTIONS

Outline Drawing

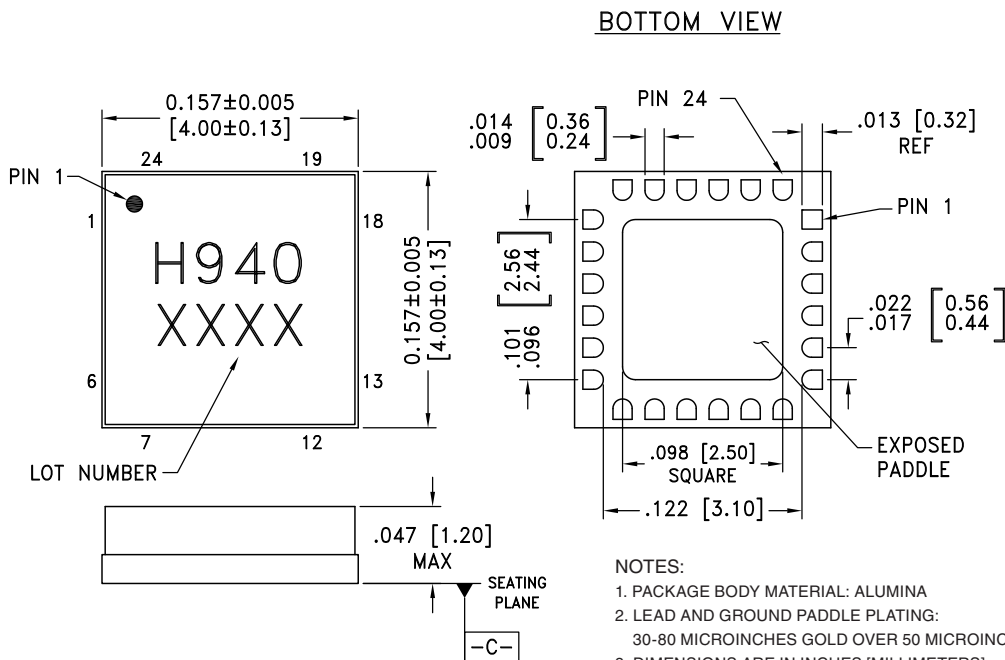

Package Information

Part Number	Package Body Material	Lead Finish	MSL Rating	Package Marking ^[2]
HMC940LC4B	Alumina, White	Gold over Nickel	MSL3 ^[1]	H940 XXXX

[1] Max peak reflow temperature of 260 °C

[2] 4-Digit lot number XXXX



13 Gbps, 1:4 FANOUT BUFFER w/ PROGRAMMABLE OUTPUT VOLTAGE

Pin Descriptions

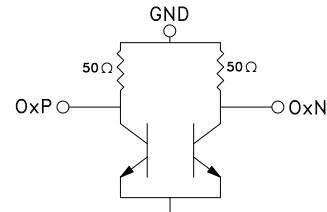
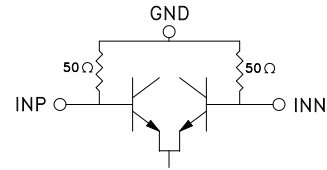
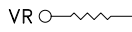
Pin Number	Function	Description	Interface Schematic
1, 6, 8, 11, 13, 18, 19, 24	GND	These pins must be connected to a high quality RF/DC ground.	
2, 3, 4, 5, 14, 15, 16, 17	O1P, O1N, O2P, O2N, O3N, O3P, O4N, O4P	Differential Outputs: Current Mode Logic (CML) referenced to positive supply.	
7, 12, 22	N/C	The pins are not connected internally; however, all data shown herein was measured with these pins connected to RF/DC ground externally.	
9, 10	INP, INN	Differential Inputs: Current Mode Logic (CML) referenced to positive supply	
20, 23 Package Base	Vee	These pins and the exposed paddle must be connected to the negative voltage supply.	
21	VR	Output level control. Output level may be increased or decreased by applying a voltage to VR per "Output Differential vs. VR" plot.	



**13 Gbps, 1:4 FANOUT BUFFER
w/ PROGRAMMABLE OUTPUT VOLTAGE**

Evaluation PCB

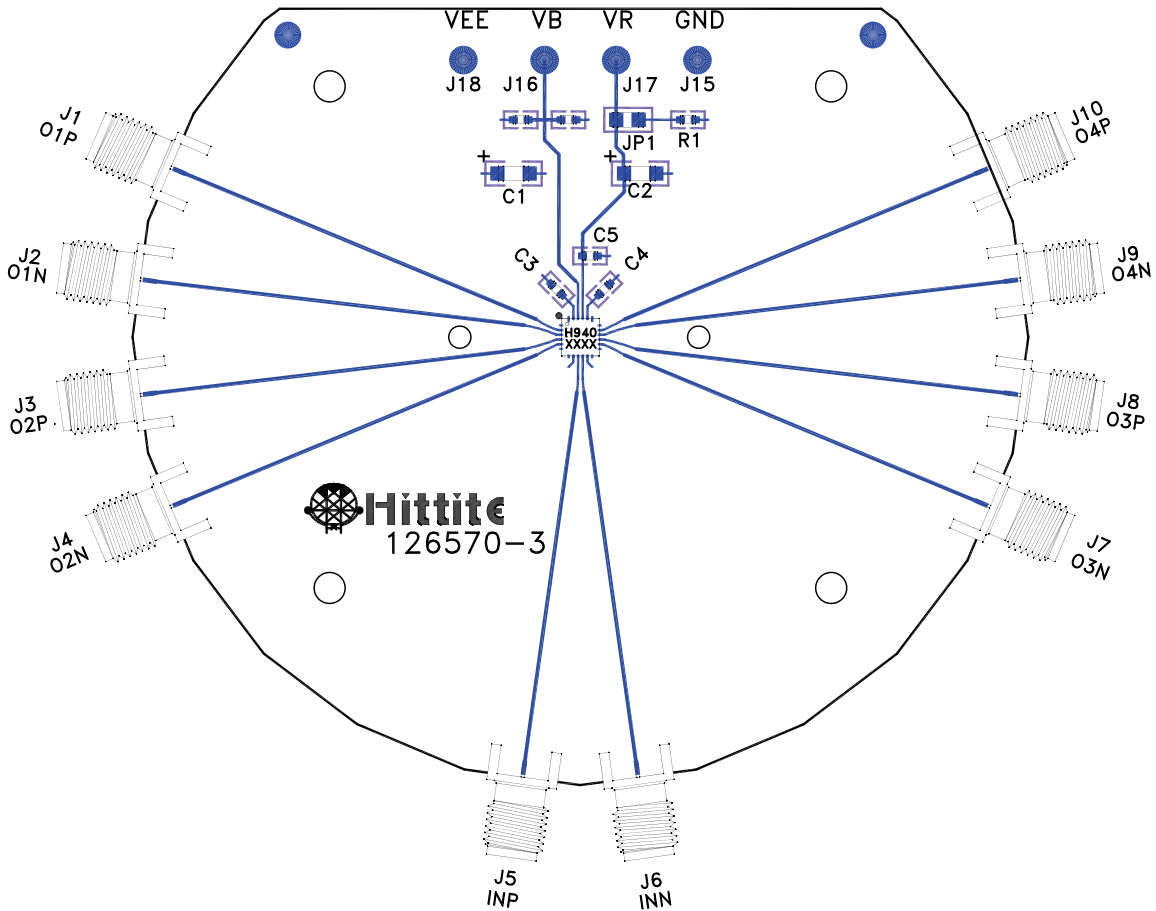

List of Materials for Evaluation PCB 126572 [1]

Item	Description
J1 - J10	PCB Mount SMA RF Connectors
J15 - J18	DC Pin
JP1	0.1" Header with Shorting Jumper
C1, C2	4.7 μ F Capacitor, Tantalum
C3 - C5	100 pF, Capacitor, 0603 Pkg
R1	10 Ohm Resistor, 0603 Pkg.
U1	HMC940LC4B High Speed Logic, Fanout Buffer
PCB [2]	126570 Evaluation Board

[1] Reference this number when ordering complete evaluation PCB

[2] Circuit Board Material: Arlon 25FR or Rogers 4350

The circuit board used in the application should use RF circuit design techniques. Signal lines should have 50 Ohm impedance while the package ground leads should be connected directly to the ground plane similar to that shown. The exposed packaged base should be connected to Vee. A sufficient number of via holes should be used to connect the top and bottom ground planes. The evaluation circuit board shown is available from Hittite upon request. Install jumper on JP1 to short VR to GND for normal operation.



**13 Gbps, 1:4 FANOUT BUFFER
w/ PROGRAMMABLE OUTPUT VOLTAGE**

Application Circuit

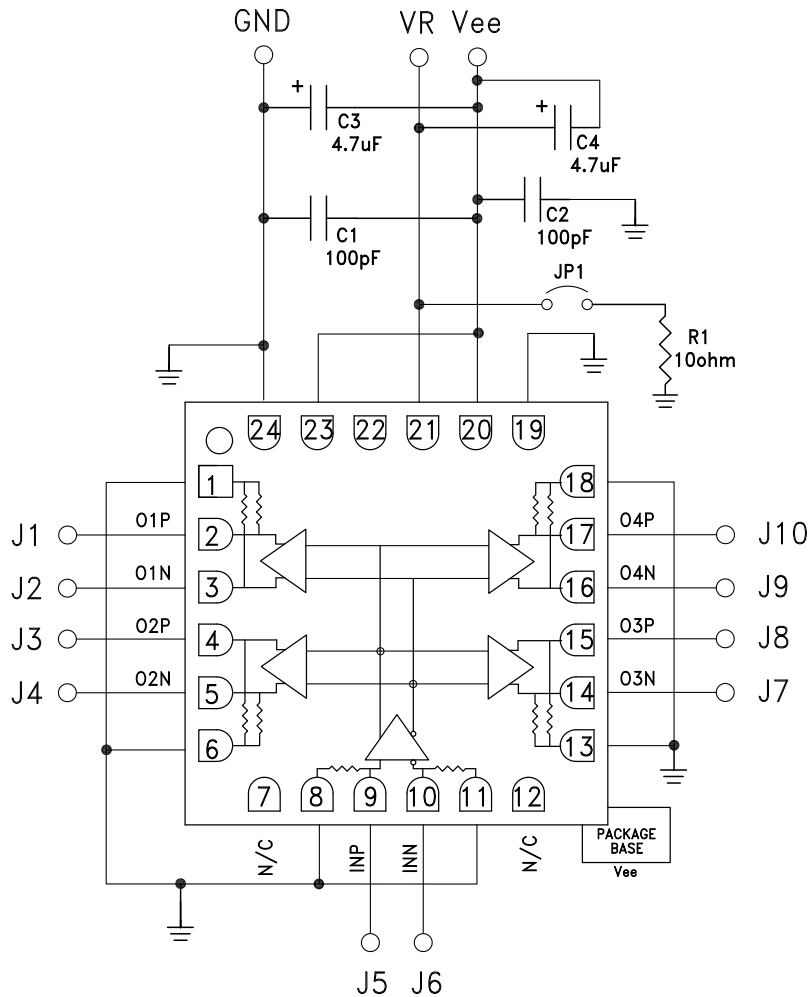

Компания «Life Electronics» занимается поставками электронных компонентов импортного и отечественного производства от производителей и со складов крупных дистрибьюторов Европы, Америки и Азии.

С конца 2013 года компания активно расширяет линейку поставок компонентов по направлению коаксиальный кабель, кварцевые генераторы и конденсаторы (керамические, пленочные, электролитические), за счёт заключения дистрибьюторских договоров

Мы предлагаем:

- Конкурентоспособные цены и скидки постоянным клиентам.
- Специальные условия для постоянных клиентов.
- Подбор аналогов.
- Поставку компонентов в любых объемах, удовлетворяющих вашим потребностям.
- Приемлемые сроки поставки, возможна ускоренная поставка.
- Доставку товара в любую точку России и стран СНГ.
- Комплексную поставку.
- Работу по проектам и поставку образцов.
- Формирование склада под заказчика.
- Сертификаты соответствия на поставляемую продукцию (по желанию клиента).
- Тестирование поставляемой продукции.
- Поставку компонентов, требующих военную и космическую приемку.
- Входной контроль качества.
- Наличие сертификата ISO.

В составе нашей компании организован Конструкторский отдел, призванный помогать разработчикам, и инженерам.

Конструкторский отдел помогает осуществить:

- Регистрацию проекта у производителя компонентов.
- Техническую поддержку проекта.
- Защиту от снятия компонента с производства.
- Оценку стоимости проекта по компонентам.
- Изготовление тестовой платы монтаж и пусконаладочные работы.



Тел: +7 (812) 336 43 04 (многоканальный)

Email: org@lifeelectronics.ru