



## Features

- Compliant with AEC-Q200 Rev-C Stress Test Qualification for Passive Components in Automotive Applications
- Compact design to save board space - 1206 footprint
- Small size results in very fast time to react to fault events
- Symmetrical design
- Low profile
- RoHS compliant\* and halogen free\*\*
- Agency recognition:   

## MF-NSMF Series - PTC Resettable Fuses

### Electrical Characteristics

Model	V max. Volts	I max. Amps	I <sub>hold</sub>	I <sub>trip</sub>	Resistance		Max. Time To Trip		Tripped Power Dissipation
			Amperes at 23 °C		Ohms at 23 °C		Amperes at 23 °C	Seconds at 23 °C	Watts at 23 °C
			Hold	Trip	R <sub>Min.</sub>	R <sub>1Max.</sub>			Typ.
MF-NSMF012	30.0	10	0.12	0.29	1.35	8.50	1.0	0.20	0.4
MF-NSMF020	24.0	10	0.20	0.46	0.60	2.60	1.0	0.60	0.6
MF-NSMF020X***	30.0	60	0.20	0.40	0.60	3.30	1.0	0.60	0.6
MF-NSMF035	6.0	100	0.35	0.75	0.30	1.20	8.0	0.10	0.6
MF-NSMF035X****	16.0	20	0.35	0.75	0.30	1.40	3.5	0.14	0.6
MF-NSMF050	13.2	100	0.50	1.00	0.15	0.70	8.0	0.10	0.4
MF-NSMF075	6.0	100	0.75	1.50	0.10	0.40	8.0	0.10	0.4
MF-NSMF110	6.0	100	1.10	2.20	0.06	0.20	8.0	0.10	0.6
MF-NSMF150	6.0	100	1.50	3.00	0.03	0.13	8.0	0.30	0.6
MF-NSMF150D	6.0	100	1.50	3.00	0.03	0.11	8.0	0.30	1.0
MF-NSMF200	6.0	100	2.00	4.00	0.02	0.085	8.0	1.00	0.7

\*\*\*Features Multifuse® freeXpansion Design™ for MF-NSMF Series (CSA/TÜV pending)

\*\*\*\*Features Multifuse® freeXpansion Design™ for MF-NSMF Series (CSA pending)

### Environmental Characteristics

Operating Temperature.....	-40 °C to +85 °C
Maximum Device Surface Temperature in Tripped State .....	125 °C
Passive Aging .....	+85 °C, 1000 hours..... ±5 % typical resistance change
Humidity Aging.....	+85 °C, 85 % R.H. 1000 hours ..... ±5 % typical resistance change
Thermal Shock .....	+85 °C to -40 °C, 20 times..... ±10 % typical resistance change
Solvent Resistance.....	MIL-STD-202, Method 215..... No change
Vibration .....	MIL-STD-883C, Method 2007.1,..... No change Condition A

### Test Procedures And Requirements For Model MF-NSMF Series

Test	Test Conditions	Accept/Reject Criteria
Visual/Mech.....	Verify dimensions and materials.....	Per MF physical description
Resistance.....	In still air @ 23 °C.....	R <sub>min</sub> ≤ R ≤ R <sub>1max</sub>
Time to Trip.....	At specified current, V <sub>max</sub> , 23 °C.....	T ≤ max. time to trip (seconds)
Hold Current .....	30 min. at I <sub>hold</sub> .....	No trip
Trip Cycle Life.....	V <sub>max</sub> , I <sub>max</sub> , 100 cycles.....	No arcing or burning
Trip Endurance .....	V <sub>max</sub> , 48 hours.....	No arcing or burning
Solderability.....	ANSI/J-STD-002.....	95 % min. coverage

UL File Number .....	E174545 <a href="http://www.ul.com/">http://www.ul.com/</a> Follow link to Certifications, then UL File No., enter E174545
CSA File Number.....	CA110338 <a href="http://directories.csa-international.org/">http://directories.csa-international.org/</a> Under "Certification Record" and "File Number" enter 110338-0-000
TÜV Certificate Number .....	R 02057213 <a href="http://www.tuvdotcom.com/">http://www.tuvdotcom.com/</a> Follow link to "other certificates", enter File No. 2057213

\*RoHS Directive 2002/95/EC Jan. 27, 2003 including annex and RoHS Recast 2011/65/EU June 8, 2011.

\*\*Bourns follows the prevailing definition of "halogen free" in the industry. Bourns considers a product to be "halogen free" if (a) the Bromine (Br) content is 900 ppm or less; (b) the Chlorine (Cl) content is 900 ppm or less; and (c) the total Bromine (Br) and Chlorine (Cl) content is 1500 ppm or less.

Specifications are subject to change without notice.

Customers should verify actual device performance in their specific applications.

## Applications

- USB port protection - USB 2.0, 3.0 & OTG
- HDMI 1.4 Source protection
- PC motherboards - Plug and Play protection
- Mobile phones - Battery and port protection
- PDAs / digital cameras
- Game console port protection
- Automotive electronic control modules

## MF-NSMF Series - PTC Resettable Fuses

**BOURNS®**

Thermal Derating Chart -  $I_{hold}$  (Amps)

Model	Ambient Operating Temperature								
	-40 °C	-20 °C	0 °C	23 °C	40 °C	50 °C	60 °C	70 °C	85 °C
MF-NSMF012	0.19	0.17	0.15	0.12	0.11	0.10	0.09	0.08	0.07
MF-NSMF020	0.30	0.27	0.24	0.20	0.18	0.16	0.14	0.12	0.11
MF-NSMF020X	0.30	0.27	0.24	0.20	0.18	0.16	0.14	0.12	0.10
MF-NSMF035	0.51	0.46	0.40	0.35	0.30	0.27	0.24	0.22	0.18
MF-NSMF035X	0.58	0.51	0.44	0.35	0.31	0.28	0.24	0.21	0.16
MF-NSMF050	0.76	0.68	0.59	0.50	0.44	0.40	0.35	0.32	0.26
MF-NSMF075	1.11	1.00	0.85	0.75	0.67	0.61	0.52	0.50	0.42
MF-NSMF110	1.64	1.46	1.30	1.10	0.92	0.83	0.80	0.65	0.52
MF-NSMF150	2.20	1.99	1.77	1.50	1.34	1.23	1.10	1.01	0.84
MF-NSMF150D	2.20	1.99	1.77	1.50	1.34	1.23	1.10	1.01	0.84
MF-NSMF200	2.88	2.61	2.28	2.00	1.80	1.66	1.51	1.39	1.19

Typical Time to Trip at 23 °C



The Time to Trip curves represent typical performance of a device in a simulated application environment. Actual performance in specific customer applications may differ from these values due to the influence of other variables.

### How to Order

**MF - NSMF 020 X - 2**

Multifuse® Product Designator

Series NSMF = 1206 Surface Mount Component

Hold Current,  $I_{hold}$  012-200 (0.12 Amps - 2.00 Amps)

Options = Standard  
D = Multifuse® freeExpansion Design™  
MF-NSMF Series

Packaging Packaged per EIA 481-1  
-2 = Tape and Reel

### Typical Part Marking

Represents total content. Layout may vary.

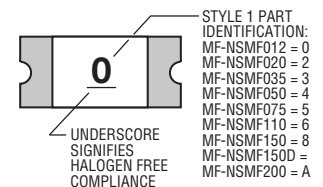

BIWEEKLY DATE CODE WILL APPEAR ON THE PACKAGING LABEL:  
WEEK 1 AND 2 = A  
WEEK 51 AND 52 = Z

# MF-NSMF Series - PTC Resettable Fuses

# BOURNS®

## Product Dimensions

Model	A		B		C		D	Style
	Min.	Max.	Min.	Max.	Min.	Max.	Min.	
MF-NSMF012	$\frac{3.00}{(0.118)}$	$\frac{3.40}{(0.134)}$	$\frac{1.40}{(0.055)}$	$\frac{1.80}{(0.071)}$	$\frac{0.70}{(0.028)}$	$\frac{1.10}{(0.043)}$	$\frac{0.25}{(0.010)}$	1
MF-NSMF020	$\frac{3.00}{(0.118)}$	$\frac{3.40}{(0.134)}$	$\frac{1.40}{(0.055)}$	$\frac{1.80}{(0.071)}$	$\frac{0.48}{(0.019)}$	$\frac{0.85}{(0.033)}$	$\frac{0.25}{(0.010)}$	1
MF-NSMF020X	$\frac{3.00}{(0.118)}$	$\frac{3.40}{(0.134)}$	$\frac{1.40}{(0.055)}$	$\frac{1.80}{(0.071)}$	$\frac{0.40}{(0.016)}$	$\frac{0.85}{(0.033)}$	$\frac{0.25}{(0.010)}$	2
MF-NSMF035	$\frac{3.00}{(0.118)}$	$\frac{3.40}{(0.134)}$	$\frac{1.40}{(0.055)}$	$\frac{1.80}{(0.071)}$	$\frac{0.48}{(0.019)}$	$\frac{0.85}{(0.033)}$	$\frac{0.25}{(0.010)}$	1
MF-NSMF035X	$\frac{3.00}{(0.118)}$	$\frac{3.40}{(0.134)}$	$\frac{1.40}{(0.055)}$	$\frac{1.80}{(0.071)}$	$\frac{0.40}{(0.016)}$	$\frac{0.85}{(0.033)}$	$\frac{0.25}{(0.010)}$	2
MF-NSMF050	$\frac{3.00}{(0.118)}$	$\frac{3.40}{(0.134)}$	$\frac{1.40}{(0.055)}$	$\frac{1.80}{(0.071)}$	$\frac{0.48}{(0.019)}$	$\frac{0.85}{(0.033)}$	$\frac{0.25}{(0.010)}$	1
MF-NSMF075	$\frac{3.00}{(0.118)}$	$\frac{3.40}{(0.134)}$	$\frac{1.40}{(0.055)}$	$\frac{1.80}{(0.071)}$	$\frac{0.40}{(0.016)}$	$\frac{0.70}{(0.028)}$	$\frac{0.25}{(0.010)}$	1
MF-NSMF110	$\frac{3.00}{(0.118)}$	$\frac{3.40}{(0.134)}$	$\frac{1.40}{(0.055)}$	$\frac{1.80}{(0.071)}$	$\frac{0.40}{(0.016)}$	$\frac{0.70}{(0.028)}$	$\frac{0.25}{(0.010)}$	1
MF-NSMF150	$\frac{3.00}{(0.118)}$	$\frac{3.40}{(0.134)}$	$\frac{1.40}{(0.055)}$	$\frac{1.80}{(0.071)}$	$\frac{0.40}{(0.016)}$	$\frac{0.70}{(0.028)}$	$\frac{0.25}{(0.010)}$	1
MF-NSMF150D	$\frac{3.00}{(0.118)}$	$\frac{3.40}{(0.134)}$	$\frac{1.40}{(0.055)}$	$\frac{1.80}{(0.071)}$	$\frac{0.40}{(0.016)}$	$\frac{0.75}{(0.030)}$	$\frac{0.25}{(0.010)}$	1
MF-NSMF200	$\frac{3.00}{(0.118)}$	$\frac{3.50}{(0.138)}$	$\frac{1.40}{(0.055)}$	$\frac{1.80}{(0.071)}$	$\frac{0.70}{(0.028)}$	$\frac{1.60}{(0.063)}$	$\frac{0.25}{(0.010)}$	1

Packaging: 3000 pcs. per reel.

DIMENSIONS:  $\frac{\text{MM}}{\text{(INCHES)}}$

### Style 1 Top and Bottom View



### Style 1 Side View

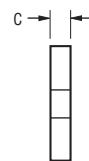

### Style 1 Recommended Pad Layout

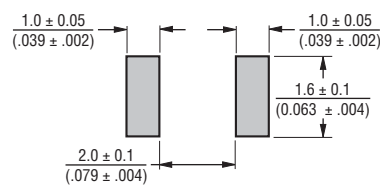

### Terminal material:

Electroless Ni under immersion Au

### Termination pad solderability:

Standard Au finish:  
Meets ANSI/J-STD-002 Category 2.

### Recommended Storage:

40 °C max./70 % RH max.

### Style 2 Top View



### Style 2 Bottom View

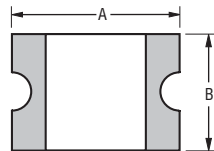

### Style 2 Side View

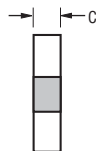

### Style 2 Recommended Pad Layout

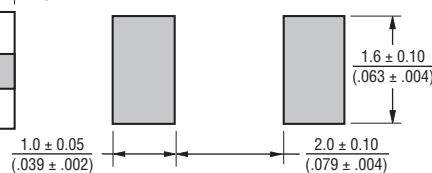

## Solder Reflow Recommendations



### Notes:

- MF-NSMF models cannot be wave soldered. Please contact Bourns for hand soldering recommendations.
- If reflow temperatures exceed the recommended profile, devices may not meet the performance requirements.
- Compatible with Pb and Pb-free solder reflow profiles.
- Excess solder may cause a short circuit, especially during hand soldering. Please refer to the Multifuse® Polymer PTC Soldering Recommendation guidelines.

# MF-NSMF Series Tape and Reel Specifications

# BOURNS®

Tape Dimensions	MF-NSMF012 & MF-NSMF200 per EIA 481-1	MF-NSMF020 ~ MF-NSMF050 & MF-NSMF150D per EIA 481-1	MF-NSMF075 ~ MF-NSMF150 per EIA 481-1	MF-NSMF020X & MF-NSMF035X per EIA 481-1
W	$8.0 \pm 0.30$ (0.315 ± 0.012)	$8.0 \pm 0.30$ (0.315 ± 0.012)	$8.0 \pm 0.30$ (0.315 ± 0.012)	$8.0 \pm 0.30$ (0.315 ± 0.012)
P <sub>0</sub>	$4.0 \pm 0.10$ (0.157 ± 0.004)	$4.0 \pm 0.10$ (0.157 ± 0.004)	$4.0 \pm 0.10$ (0.157 ± 0.004)	$4.0 \pm 0.10$ (0.157 ± 0.004)
P <sub>1</sub>	$4.0 \pm 0.10$ (0.157 ± 0.004)	$4.0 \pm 0.10$ (0.157 ± 0.004)	$4.0 \pm 0.10$ (0.157 ± 0.004)	$4.0 \pm 0.10$ (0.157 ± 0.004)
P <sub>2</sub>	$2.0 \pm 0.05$ (0.079 ± 0.002)	$2.0 \pm 0.05$ (0.079 ± 0.002)	$2.0 \pm 0.05$ (0.079 ± 0.002)	$2.0 \pm 0.05$ (0.079 ± 0.002)
A <sub>0</sub>	$1.90 \pm 0.10$ (0.075 ± 0.004)	$1.90 \pm 0.10$ (0.075 ± 0.004)	$1.90 \pm 0.10$ (0.075 ± 0.004)	$1.90 \pm 0.10$ (0.075 ± 0.004)
B <sub>0</sub>	$3.50 \pm 0.10$ (0.138 ± 0.004)	$3.45 \pm 0.10$ (0.136 ± 0.004)	$3.45 \pm 0.10$ (0.136 ± 0.004)	$3.55 \pm 0.10$ (0.140 ± 0.004)
B <sub>1</sub> max.	$4.35$ (0.171)	$4.35$ (0.171)	$4.35$ (0.171)	$4.35$ (0.171)
D <sub>0</sub>	$1.5 + 0.10/-0.0$ (0.059 + 0.004/-0)	$1.5 + 0.10/-0.0$ (0.059 + 0.004/-0)	$1.5 + 0.10/-0.0$ (0.059 + 0.004/-0)	$1.5 + 0.10/-0.0$ (0.059 + 0.004/-0)
F	$3.5 \pm 0.05$ (0.138 ± 0.002)	$3.5 \pm 0.05$ (0.138 ± 0.002)	$3.5 \pm 0.05$ (0.138 ± 0.002)	$3.5 \pm 0.05$ (0.138 ± 0.002)
E <sub>1</sub>	$1.75 \pm 0.10$ (0.069 ± 0.004)	$1.75 \pm 0.10$ (0.069 ± 0.004)	$1.75 \pm 0.10$ (0.069 ± 0.004)	$1.75 \pm 0.10$ (0.069 ± 0.004)
E <sub>2</sub> min.	$6.25$ (0.246)	$6.25$ (0.246)	$6.25$ (0.246)	$6.25$ (0.246)
T max.	$0.6$ (0.024)	$0.6$ (0.024)	$0.6$ (0.024)	$0.6$ (0.024)
T <sub>1</sub> max.	$0.1$ (0.004)	$0.1$ (0.004)	$0.1$ (0.004)	$0.1$ (0.004)
K <sub>0</sub>	$1.35 \pm 0.10$ (0.053 ± 0.004)	$1.04 \pm 0.10$ (0.041 ± 0.004)	$0.85 \pm 0.10$ (0.033 ± 0.004)	$0.80 \pm 0.10$ (0.032 ± 0.004)
Leader min.	$390$ (15.35)	$390$ (15.35)	$390$ (15.35)	$390$ (15.35)
Trailer min.	$160$ (6.30)	$160$ (6.30)	$160$ (6.30)	$160$ (6.30)
<b>Reel Dimensions</b>				
A max.	$185$ (7.28)	$185$ (7.28)	$185$ (7.28)	$185$ (7.28)
N min.	$50$ (1.97)	$50$ (1.97)	$50$ (1.97)	$50$ (1.97)
W <sub>1</sub>	$8.4 + 1.5/-0.0$ (0.331 + 0.059/-0.0)	$8.4 + 1.5/-0.0$ (0.331 + 0.059/-0.0)	$8.4 + 1.5/-0.0$ (0.331 + 0.059/-0.0)	$8.4 + 1.5/-0.0$ (0.331 + 0.059/-0.0)
W <sub>2</sub> max.	$14.4$ (0.567)	$14.4$ (0.567)	$14.4$ (0.567)	$14.4$ (0.567)

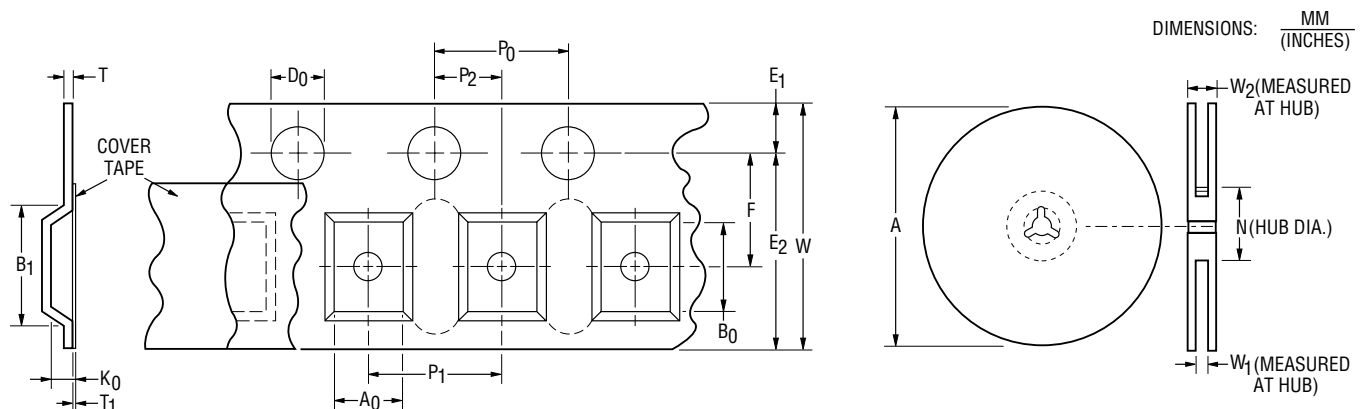

Specifications are subject to change without notice.  
Customers should verify actual device performance in their specific applications.

Компания «Life Electronics» занимается поставками электронных компонентов импортного и отечественного производства от производителей и со складов крупных дистрибьюторов Европы, Америки и Азии.

С конца 2013 года компания активно расширяет линейку поставок компонентов по направлению коаксиальный кабель, кварцевые генераторы и конденсаторы (керамические, пленочные, электролитические), за счёт заключения дистрибьюторских договоров

Мы предлагаем:

- Конкурентоспособные цены и скидки постоянным клиентам.
- Специальные условия для постоянных клиентов.
- Подбор аналогов.
- Поставку компонентов в любых объемах, удовлетворяющих вашим потребностям.
- Приемлемые сроки поставки, возможна ускоренная поставка.
- Доставку товара в любую точку России и стран СНГ.
- Комплексную поставку.
- Работу по проектам и поставку образцов.
- Формирование склада под заказчика.
- Сертификаты соответствия на поставляемую продукцию (по желанию клиента).
- Тестирование поставляемой продукции.
- Поставку компонентов, требующих военную и космическую приемку.
- Входной контроль качества.
- Наличие сертификата ISO.

В составе нашей компании организован Конструкторский отдел, призванный помогать разработчикам, и инженерам.

Конструкторский отдел помогает осуществить:

- Регистрацию проекта у производителя компонентов.
- Техническую поддержку проекта.
- Защиту от снятия компонента с производства.
- Оценку стоимости проекта по компонентам.
- Изготовление тестовой платы монтаж и пусконаладочные работы.



Тел: +7 (812) 336 43 04 (многоканальный)  
Email: [org@lifeelectronics.ru](mailto:org@lifeelectronics.ru)