



ETA-USA

HIGH QUALITY SWITCHING POWER SUPPLIES

AC/DC SWITCHING POWER SUPPLY
SINGLE CHANNEL OUTPUT
500 WATTS
UNIVERSAL INPUT

ZMP500-SX-F-W-D SERIES

General Description



Features

1. Current sharing ("-D"), up to 4 units can be paralleled within 10% accuracy at full load
2. Short circuit protection
3. Over load protection
4. Over voltage protection
5. Remote inhibit function

Options

Comes with either top fan (denoted by suffix "-T") or end fan (denoted by "-S")

Application

Broad needs

Input

Input Voltage Range:	AC90~264V
Frequency:	50/60 Hz
Frequency Range:	47~63 Hz
Phase:	Single
Inrush Current: *1, *4	<17.5A peak@115VAC; <35A peak@230VAC cold start at 25 degrees C
Input Current:	6A max at 115VAC





ETA-USA

HIGH QUALITY SWITCHING POWER SUPPLIES

Output Characteristic	Unit	Models						
		ZMP500-12SX-F-W-D	ZMP500-24SX-F-W-D	ZMP500-30SX-F-W-D	ZMP500-36SX-F-W-D	ZMP500-48SX-F-W-D	ZMP500-54SX-F-W-D	ZMP500-57SX-F-W-D
Output Voltage	Vdc	12	24	30	36	48	54	57
Output Current	A	30	15	12	10	7.5	6.67	6.32
Max Output Current	A	41.67	20.84	16.67	13.89	10.42	9.26	8.78
Ripple & Noise(max)	mVpp	120	240	300	360	480	540	570
Hold up time	mS	20 mS at 360W load, 115VAC input						
Regulation								
O/P Regulation [max]	mV	±5% at 25°C with input and output adjusted to factory settings						

Efficiency *1	%	At AC100V 83% At AC 200V 86%
Power Factor *1		>0.9 @ 115VAC / 230VAC

Environmental Specification	
Operating Temperature*3	0 to +50 °C Derating 2.5% / °C from 50°C to 70°C
Temperature coefficient	±0.04% / °C
Operating Humidity	5~95% RH non condensing
Isolation Voltage	Input-Output 5656 VDC Input-Ground 2121 VDC Output Ground 707 VDC
Cooling	Forced air cooling
Leakage current	<300µA @ 264VAC
MTBF	>100,000 hours
Environmental Agencies	
Safety	UL60601-1, CSA-C22.2 No. 601.1M9 , TUV EN60601-1, CB IEC60601-1
EMI Safety	EN60601-2, FCC Part 18 Class B, EN55011 Class B, CE
Function/Protection	
Over current Protection	110% to 150% max rating. Auto recovery
Over voltage Protection	110 to 130% of output. Latching type AC recycle
Remote Sense	Not Available
Remote Control	Not Available
Series Operation	Available
Parallel Operation	Available, up to 4
Standby	5V/1A standby output, 12V/1A for fan
Mechanical	
Dimension [mm]	203.2L x 118.5W x 38.5H





ETA-USA

HIGH QUALITY SWITCHING POWER SUPPLIES

Conditions:

- *1 Rated input and Rated output
- *2 at Output current quick change 25% to 75%
- *3 At 100% load (convection cooling)
- *4 Cold start at 25 °C Ambient temp.





ETA-USA

HIGH QUALITY SWITCHING POWER SUPPLIES

Mechanical Drawings

ZMP500-SX-F-W-D

Option : U, U-Channel

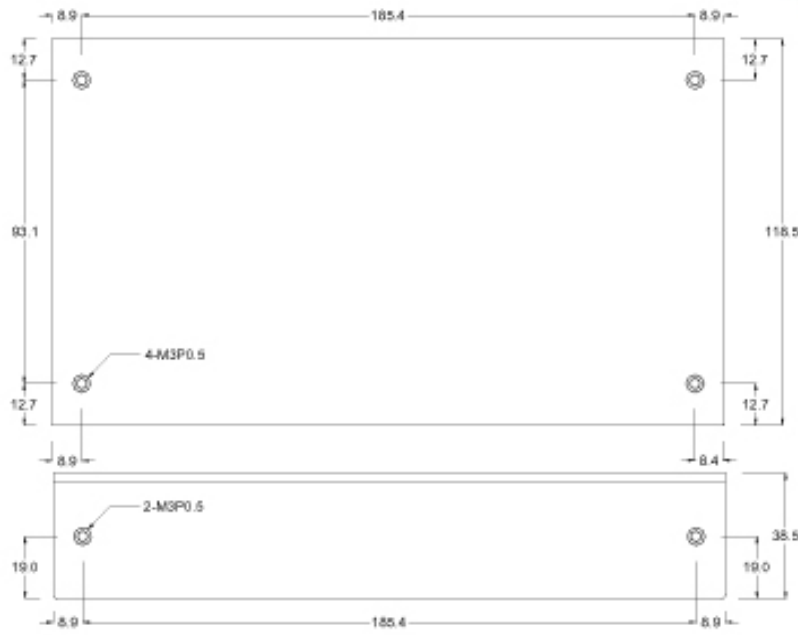
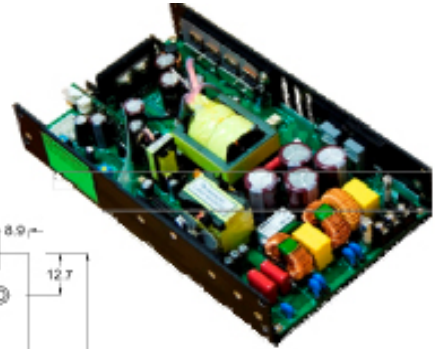

CN4



CN1

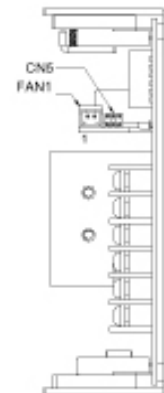
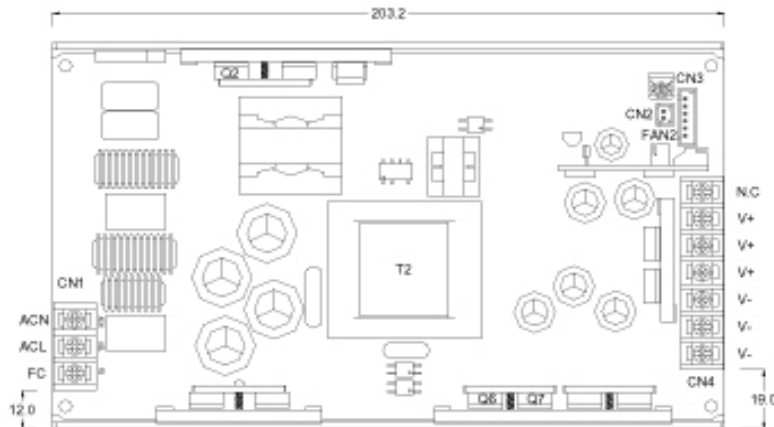

FAN FAULT FAN FULL SPEED

CN3 P2 5-6P (OPTION) Molex P/N 48152-0610 OR Equivalent	PIN1	Current Sense
	PIN2	Inhibit
	PIN3	GND
	PIN4	5Vsb
	PIN5	-Sensor
	PIN6	+Sensor

CN2 P2 5-2P Molex P/N 48152-0210 OR Equivalent	PIN1	5Vsb
	PIN2	GND
FAN1 P2 5-2P Molex P/N 48153-0210 OR Equivalent	PIN1	12V FAN +
	PIN2	12V FAN -
FAN2 P2 5-2P (With speed control) Molex P/N 48152-0210 OR Equivalent	PIN1	FAN +
	PIN2	FAN -



CN5 P2 5-5P
Molex P/N 90122-0123
OR Equivalent





ETA-USA

HIGH QUALITY SWITCHING POWER SUPPLIES

Top fan (“-T”)

Option : T, Fan on top

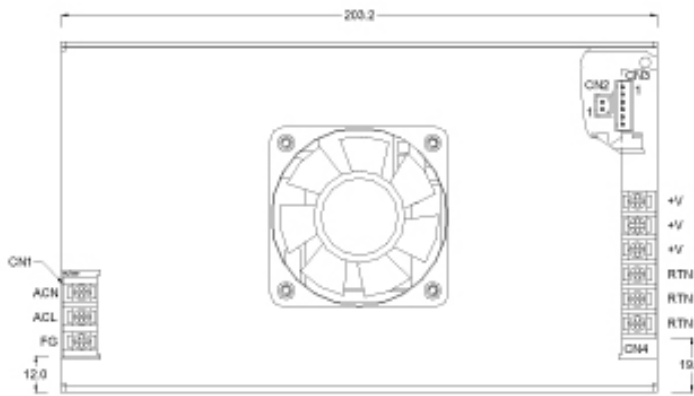
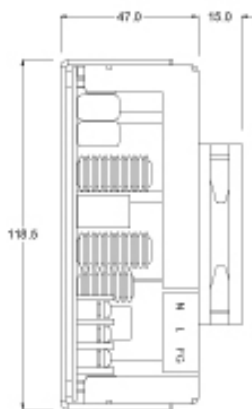
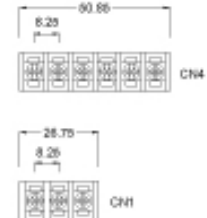
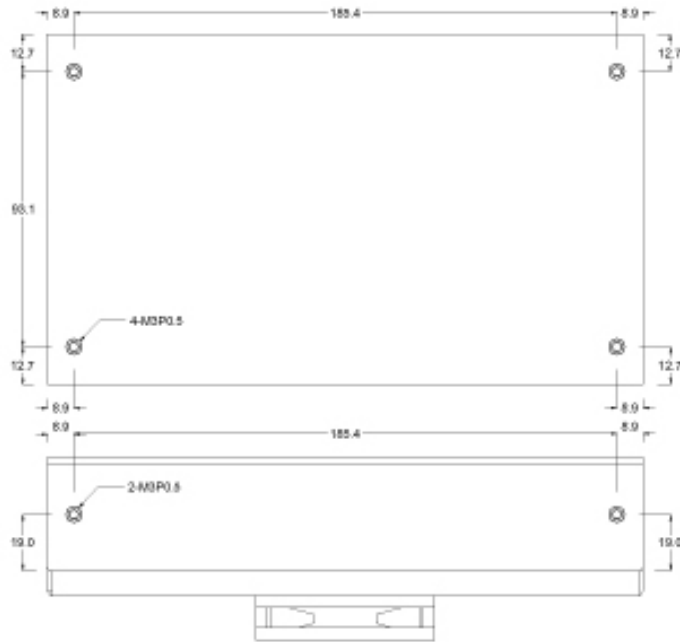
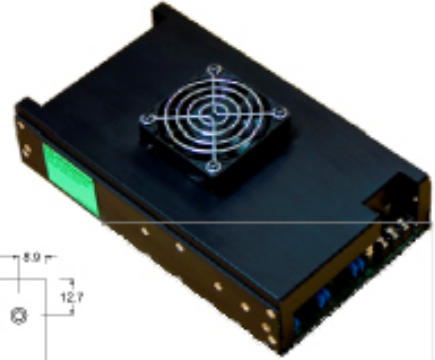

CN3 P2.5-6P (OPTION) Molex P/N 48152-0210 OR Equivalent	PIN1	Current Sense
	PIN2	Inhibit
	PIN3	GND
	PIN4	5Vsb
	PIN5	-Sensor
	PIN6	+Sensor

CN2 P2.5-2P Molex P/N 48152-0210 OR Equivalent	PIN1	5Vsb
	PIN2	GND
FAN1 P2.5-2P Molex P/N 48153-0210 OR Equivalent	PIN1	12V FAN +
	PIN2	12V FAN -

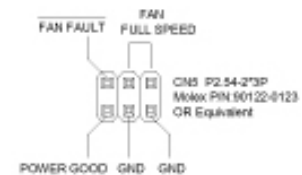



ETA-USA

HIGH QUALITY SWITCHING POWER SUPPLIES

End fan (“-S”)

Option : S, End Fan

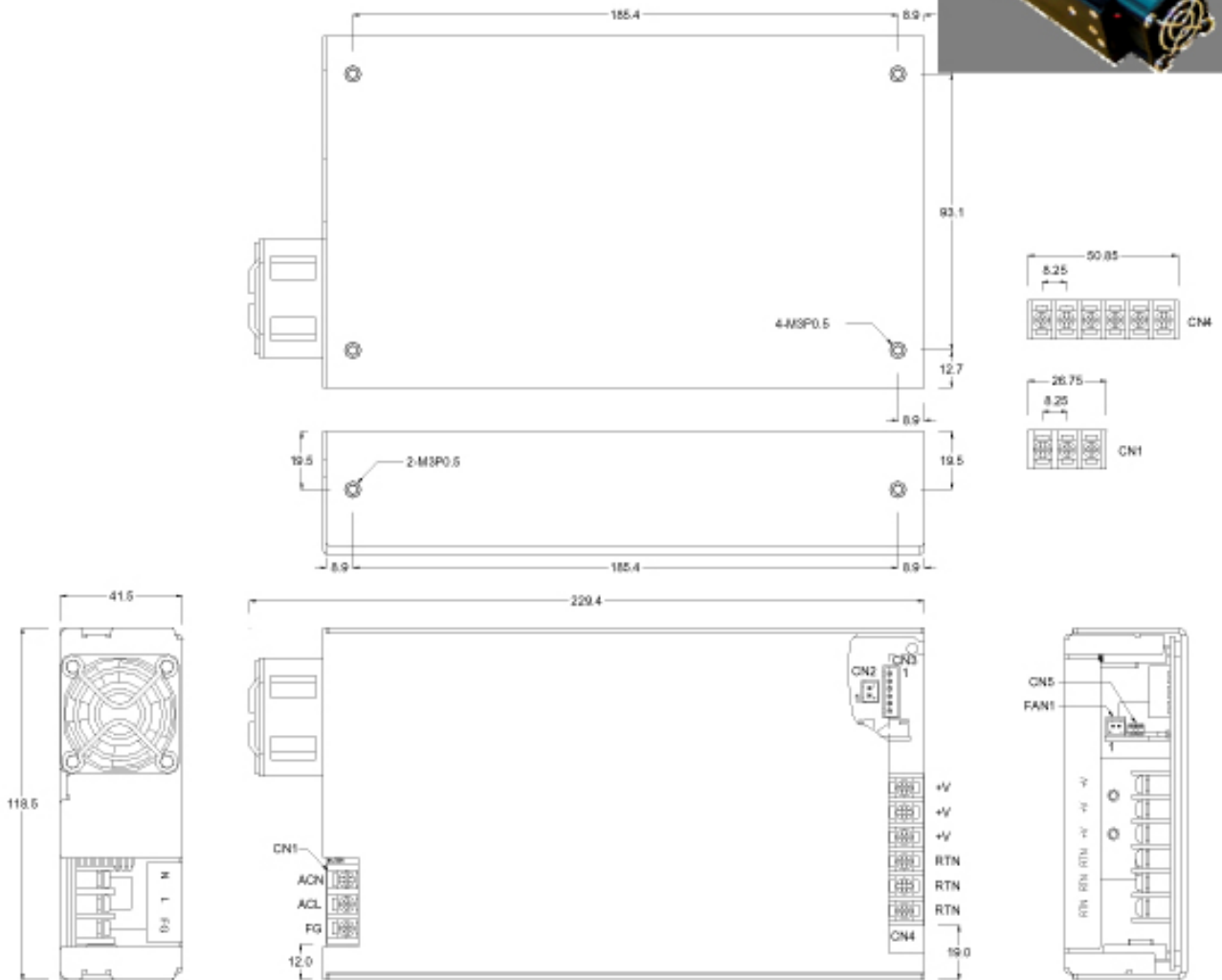
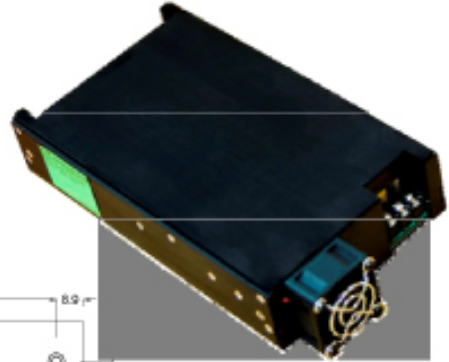

CN3 P2.5-6P (OPTION) Molex PIN-45152-0210 OR Equivalent	PIN1	Current Sense
	PIN2	Inhibit
	PIN3	GND
	PIN4	5Vsb
	PIN5	-Sensor
	PIN6	+Sensor

CN2 P2.5-2P Molex PIN-45152-0210 OR Equivalent	PIN1	5Vsb
	PIN2	GND
FAN1 P2.5-2P Molex PIN-45153-0210 OR Equivalent	PIN1	12V FAN +
	PIN2	12V FAN -

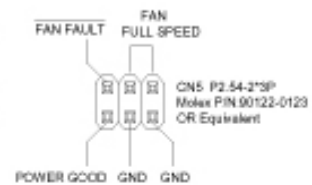

Компания «Life Electronics» занимается поставками электронных компонентов импортного и отечественного производства от производителей и со складов крупных дистрибьюторов Европы, Америки и Азии.

С конца 2013 года компания активно расширяет линейку поставок компонентов по направлению коаксиальный кабель, кварцевые генераторы и конденсаторы (керамические, пленочные, электролитические), за счёт заключения дистрибьюторских договоров

Мы предлагаем:

- Конкурентоспособные цены и скидки постоянным клиентам.
- Специальные условия для постоянных клиентов.
- Подбор аналогов.
- Поставку компонентов в любых объемах, удовлетворяющих вашим потребностям.
- Приемлемые сроки поставки, возможна ускоренная поставка.
- Доставку товара в любую точку России и стран СНГ.
- Комплексную поставку.
- Работу по проектам и поставку образцов.
- Формирование склада под заказчика.
- Сертификаты соответствия на поставляемую продукцию (по желанию клиента).
- Тестирование поставляемой продукции.
- Поставку компонентов, требующих военную и космическую приемку.
- Входной контроль качества.
- Наличие сертификата ISO.

В составе нашей компании организован Конструкторский отдел, призванный помогать разработчикам, и инженерам.

Конструкторский отдел помогает осуществить:

- Регистрацию проекта у производителя компонентов.
- Техническую поддержку проекта.
- Защиту от снятия компонента с производства.
- Оценку стоимости проекта по компонентам.
- Изготовление тестовой платы монтаж и пусконаладочные работы.



Тел: +7 (812) 336 43 04 (многоканальный)

Email: org@lifeelectronics.ru