

# Power Distribution Blocks up to 420A, 600V

## 163 Series



- Available in 1-, 2- or 3-pole versions
- Smaller package...requires 40% less panel space than the 164 series.
- Touch-safe design. Extended barriers and optional cover to guard against accidental contact when live.
- Thermoset material to withstand high heat applications.
- Wide range of input/output terminations (see page 2 for details).
- Optional cover is clear with write-on surface for field termination identification (Order part number CPDB series).
- For industrial controls, HVAC and other control automation panel applications.
- Mounting slots allow greater flexibility to fit pre-drilled panel holes.

### 163 Series Power Distribution Blocks (Replaces Cooper Bussmann 164 Series)

**Ratings:** Up to 420A, 600V

**Construction:**

Thermoset plastic with UL rating 160°C; ASTM rating to 260°C.  
UL 94V0.  
Tin-plated aluminum connectors

**Agency Information:**







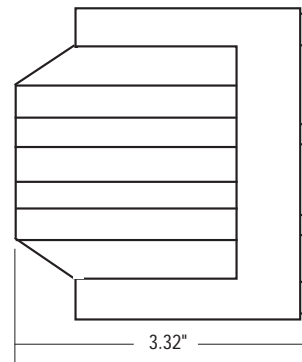
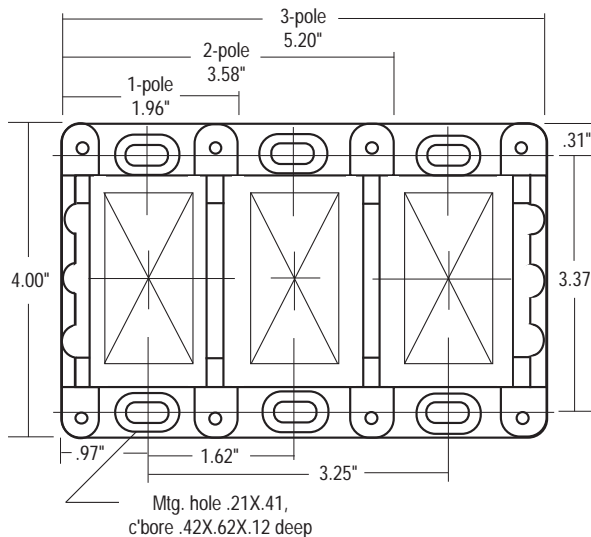
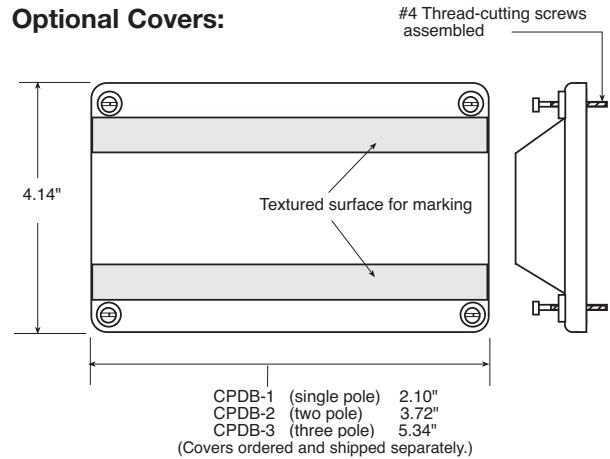































UL Recognized: UL E221592  
General Industrial Class per UL1059  
CSA Certified: CSA File 53787, Class 6228-01

**Termination Options:** See page 2.

**Optional Covers:**



INPUT/OUTPUT TERMINATION OPTIONS

Basic Part No.	Wire Size		Amps/ Pole	LINE / LOAD	
	Line Side	Load Side			
16301	250kcmil-#6 CU Only	250kcmil-#6 CU Only	255		
16303	350kcmil-#6 CU-AL	350kcmil-#6 CU-AL	310		
16306	500kcmil-#6 CU-AL	500kcmil-#6 CU-AL	380		
16321	2/0-#14CU, 2/0-#8AL	#4-#14CU, #4-#8AL	175		
16323	350kcmil-#6CU-AL	#4-#14CU, #4-#12AL	310		
16325	2/0-#14CU, 2/0-#8AL	#4-#14CU, #4-#8AL	350		
16330	500kcmil-#6CU-AL	#2-#14CU, #2-#12AL	380		
16332	350kcmil-#6CU-AL	(3) #2-#14CU, #2-#8AL (2) 1/0-#14CU, 1/0-#8AL	310		
16335	500kcmil-#6CU-AL	(3) #2-#14CU, #2-#8AL (2) 1/0-#14CU, 1/0-#8AL	380		
16370	350kcmil-#6CU-AL	#4-#14CU, #4-#12AL	310		
16371	350kcmil-#6CU-AL	(6) #2-#14CU, #2-#8AL (3) 1/0-#14CU, 1/0-#8AL	310		
16372	350kcmil-#6CU-AL	(21) #10-#14CU, #10AL	310		
16373	350kcmil-#6CU-AL	(14) #10-#14CU, #10AL (3) 1/0-#14CU-AL	310		
16375	600kcmil-#2CU-AL	#4-#14CU, #4-#12AL	420		
16376	600kcmil-#2CU-AL	(6) #2-#14CU, #2-#8AL (3) 1/0-#14CU, 1/0-#8AL	420		
16378	500kcmil-#6CU-AL	Stud Size (2) 1/4-20X1	380		
16390	Stud Size 3/8-16X1-1/8	Stud Size 3/8-16X1-1/8	250		
16394	Stud Size 1/2-13X1-1/16	Stud Size 1/2-13X1-1/16	400		
16395	Stud Size 3/8-16X1-7/16	Stud Size (2) 1/4-20X9/16	310		

Cross Reference/ Replacement Guide

NEW Buss Part No.	Replaces these part numbers.				
	Old Buss No.	Connectron	Marathon Series	Gould Series	ILSCO Series
16303	16302				
16306	16401, 16305		143	66	PDB
16321	16320		144	67	
16323	16322		145	68	
16370		350CCC		69	
16371	16420, 16421 16423, 16535	350BBA			
16375	16521	600CCC			
16376	16425, 16431, 16520	600BBA			
16378	16481				
16382	16380, 16480				
16390	16391				
16394	16493, 16593				
16395	16490				

**Note: Cooper Bussmann 164 Series was discontinued and replaced by the new Cooper Bussmann 163 Series in 1996. Contact Cooper Bussmann for a direct cross on a specific part number.**

Ordering Information:

163 Series blocks are available in 1, 2 or 3 poles.

To order: **Basic Part No. + Number of poles**

Examples:

16301-1 = (one-pole block)

16303-3 = (three-pole block)

The only controlled copy of this Data Sheet is the electronic read-only version located on the Cooper Bussmann Network Drive. All other copies of this document are by definition uncontrolled. This bulletin is intended to clearly present comprehensive product data and provide technical information that will help the end user with design applications. Cooper Bussmann reserves the right, without notice, to change design or construction of any products and to discontinue or limit distribution of any products. Cooper Bussmann also reserves the right to change or update, without notice, any technical information contained in this bulletin. Once a product has been selected, it should be tested by the user in all possible applications.

Компания «Life Electronics» занимается поставками электронных компонентов импортного и отечественного производства от производителей и со складов крупных дистрибьюторов Европы, Америки и Азии.

С конца 2013 года компания активно расширяет линейку поставок компонентов по направлению коаксиальный кабель, кварцевые генераторы и конденсаторы (керамические, пленочные, электролитические), за счёт заключения дистрибьюторских договоров

Мы предлагаем:

- Конкурентоспособные цены и скидки постоянным клиентам.
- Специальные условия для постоянных клиентов.
- Подбор аналогов.
- Поставку компонентов в любых объемах, удовлетворяющих вашим потребностям.
- Приемлемые сроки поставки, возможна ускоренная поставка.
- Доставку товара в любую точку России и стран СНГ.
- Комплексную поставку.
- Работу по проектам и поставку образцов.
- Формирование склада под заказчика.
- Сертификаты соответствия на поставляемую продукцию (по желанию клиента).
- Тестирование поставляемой продукции.
- Поставку компонентов, требующих военную и космическую приемку.
- Входной контроль качества.
- Наличие сертификата ISO.

В составе нашей компании организован Конструкторский отдел, призванный помогать разработчикам, и инженерам.

Конструкторский отдел помогает осуществить:

- Регистрацию проекта у производителя компонентов.
- Техническую поддержку проекта.
- Защиту от снятия компонента с производства.
- Оценку стоимости проекта по компонентам.
- Изготовление тестовой платы монтаж и пусконаладочные работы.



Тел: +7 (812) 336 43 04 (многоканальный)  
Email: [org@lifeelectronics.ru](mailto:org@lifeelectronics.ru)