

## FEATURES

- Full 8 × 8 crossbar connectivity**
- Fully buffered signal path supports multicast and broadcast operation**
- Optimized for dc to 4.25 Gbps data**
- Programmable receive equalization**
- Compensates for up to 30 in. of FR4 @ 4.25 Gbps**
- Programmable transmit pre-emphasis/de-emphasis**
- Compensates for up to 30 in. of FR4 @ 4.25 Gbps**
- Flexible 1.8 V to 3.3 V core supply**
- Per lane positive/negative (P/N) pair inversion for routing ease**
- Low power: 125 mW/channel at 4.25 Gbps**
- DC- or ac-coupled differential CML inputs**
- Programmable CML output levels**
- 50 Ω on-chip termination**
- −40°C to +85°C temperature range operation**
- Supports 8b10b, scrambled or uncoded nonreturn-to-zero (NRZ) data**
- I<sup>2</sup>C control interface**
- Package: 64-lead LFCSP**

## APPLICATIONS

- 1×, 2×, 4× FibreChannel**
- XAUI**
- Gigabit Ethernet over backplane**
- 10GBase-CX4**
- InfiniBand®**
- 50 Ω cables**

## GENERAL DESCRIPTION

The **ADN4600** is an asynchronous, nonblocking crosspoint switch with eight differential PECL-/CML-compatible inputs with programmable equalization and eight differential CML outputs with programmable output levels and pre-emphasis or de-emphasis. The operation of this device is optimized for NRZ data at rates up to 4.25 Gbps.

The receive inputs provide programmable equalization with nine settings to compensate for up to 30 in. of FR4 and programmable pre-emphasis with seven settings to compensate for up to 30 in. of FR4 at 4.25 Gbps.

## FUNCTIONAL BLOCK DIAGRAM

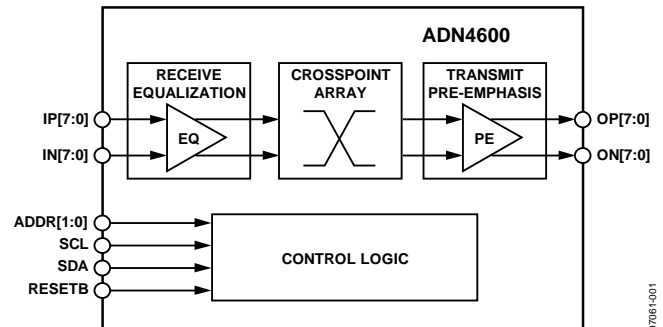

Figure 1.

The **ADN4600** nonblocking switch core implements an 8 × 8 crossbar and supports independent channel switching through the I<sup>2</sup>C control interface. Every channel implements an asynchronous path supporting NRZ data rates from dc to 4.25 Gbps. Each channel is fully independent of other channels. The **ADN4600** has low latency and very low channel-to-channel skew.

The main application for the **ADN4600** is to support switching on the backplane, line card, or cable interface sides of serial links.

The **ADN4600** is packaged in a 9 mm × 9 mm, 64-lead LFCSP package and operates from −40°C to +85°C.

## TABLE OF CONTENTS

Features .....	1	Typical Performance Characteristics .....	8
Applications.....	1	Theory of Operation .....	13
Functional Block Diagram .....	1	Introduction .....	13
General Description .....	1	Receivers.....	13
Revision History .....	2	Switch Core .....	15
Specifications.....	3	Transmitters .....	16
Electrical Specifications.....	3	I <sup>2</sup> C Control Interface.....	22
Timing Specifications .....	5	PCB Design Guidelines .....	24
Absolute Maximum Ratings.....	6	Control Register Map.....	25
ESD Caution.....	6	Package Outline Dimensions .....	28
Pin Configuration and Function Descriptions.....	7	Ordering Guide .....	28

## REVISION HISTORY

### 4/15—Rev. A to Rev. B

Changes to Table 4.....	7
Updated Outline Dimensions .....	28

### 12/12—Rev. 0 to Rev. A

Changes to Table 16.....	25
Changes to Ordering Guide .....	28

### 6/08—Revision 0: Initial Version

## SPECIFICATIONS

### ELECTRICAL SPECIFICATIONS

$V_{CC} = 1.8\text{ V}$ ,  $V_{EE} = 0\text{ V}$ ,  $V_{TTI} = V_{TTO} = V_{CC}$ ,  $R_L = 50\ \Omega$ , differential output swing = 800 mV p-p differential, 4.25 Gbps, PRBS  $2^7 - 1$ ,  $T_A = 25^\circ\text{C}$ , unless otherwise noted.

Table 1.

Parameter	Conditions	Min	Typ	Max	Unit
<b>DYNAMIC PERFORMANCE</b>					
Maximum Data Rate per Channel	In NRZ format	4.25			Gbps
Deterministic Jitter	Data rate < 4.25 Gbps; BER = $1e - 12$		30		ps p-p
Random Jitter	$V_{CC} = 1.8\text{ V}$		1.5		ps rms
Residual Deterministic Jitter with Receive Equalization	Data rate < 3.25 Gbps; 0 in. to 30 in. FR4		0.16		UI
	Data rate < 4.25 Gbps; 0 in. to 30 in. FR4		0.20		UI
Residual Deterministic Jitter with Transmit Pre-Emphasis	Data rate < 3.25 Gbps; 0 in. to 30 in. FR4		0.13		UI
	Data rate < 4.25 Gbps; 0 in. to 30 in. FR4		0.18		UI
Output Rise/Fall Time	20% to 80%		75		ps
Channel-to-Channel Skew			50		ps
Propagation Delay			1		ns
<b>OUTPUT PRE-EMPHASIS</b>					
Equalization Method	One-tap programmable pre-emphasis				
Maximum Boost	800 mV p-p output swing		6		dB
	200 mV p-p output swing		12		dB
Pre-Emphasis Tap Range	Minimum		2		mA
	Maximum		12		mA
<b>INPUT EQUALIZATION</b>					
Minimum Boost	EQBY = 1		1.5		dB
Maximum Boost	Maximum boost occurs @ 2.125 GHz		22		dB
Number of Equalization Steps			8		Steps
Gain Step Size			2.5		dB
<b>INPUT CHARACTERISTICS</b>					
Input Voltage Swing	Differential, $V_{ICM}^1 = V_{CC} - 0.6\text{ V}$ ; $V_{CC} = 3.3\text{ V}$	300		2000	mV p-p
Input Voltage Range	Single-ended absolute voltage level, $V_L$ minimum		$V_{EE} + 0.4$		V p-p
	Single-ended absolute voltage level, $V_H$ maximum		$V_{CC} + 0.5$		V p-p
Input Resistance	Single-ended	45	50	55	$\Omega$
Input Return Loss	Measured at 2.5 GHz		5		dB
<b>OUTPUT CHARACTERISTICS</b>					
Output Voltage Swing	@ dc, differential, PE = 0, default, $V_{CC} = 1.8\text{ V}$	635	740	870	mV p-p
	@ dc, differential, PE = 0, default, $V_{CC} = 3.3\text{ V}$		800		mV p-p
	@ dc, differential, PE = 0, min output level <sup>2</sup> , $V_{CC} = 1.8\text{ V}$		100		mV p-p
	@ dc, differential, PE = 0, min output level <sup>2</sup> , $V_{CC} = 3.3\text{ V}$		100		mV p-p
	@ dc, differential, PE = 0, max output level <sup>2</sup> , $V_{CC} = 1.8\text{ V}$		1300		mV p-p
	@ dc, differential, PE = 0, max output level <sup>2</sup> , $V_{CC} = 3.3\text{ V}$		1800		mV p-p
Output Voltage Range	Single-ended absolute voltage level, TxHeadroom = 0; $V_L$ min		$V_{CC} - 1.1$		V
	Single-ended absolute voltage level, TxHeadroom = 0; $V_H$ max		$V_{CC} + 0.6$		V
	Single-ended absolute voltage level, TxHeadroom = 1; $V_L$ min		$V_{CC} - 1.2$		V
	Single-ended absolute voltage level, TxHeadroom = 1; $V_H$ max		$V_{CC} + 0.6$		V
Output Current	Minimum output current per channel		2		mA
	Maximum output current per channel, $V_{CC} = 1.8\text{ V}$		21		mA
Output Resistance	Single ended	45	50	55	$\Omega$
Output Return Loss	Measured at 2.5 GHz		5		dB

Parameter	Conditions	Min	Typ	Max	Unit
<b>POWER SUPPLY</b>					
Operating Range					
$V_{CC}$	$V_{EE} = 0\text{ V}$	1.7	1.8	3.6	V
$DV_{CC}$	$V_{EE} = 0\text{ V}, DV_{CC} \leq (V_{CC} + 1.3\text{ V})$	3.0	3.3	3.6	V
$V_{TTI}$	$(V_{EE} + 0.4\text{ V} + 0.5 \times V_{ID}) < V_{TTI} < (V_{CC} + 0.5\text{ V})$	$V_{EE} + 0.4$	1.8	3.6	V
$V_{TTO}$	$(V_{CC} - 1.1\text{ V} + 0.5 \times V_{OD}) < V_{TTO} < (V_{CC} + 0.5\text{ V})$	$V_{CC} - 1.1$	1.8	3.6	V
Supply Current <sup>3</sup>					
$I_{TTO}$	All outputs enabled		63	69	mA
$I_{CC}$	All outputs enabled		460	565	mA
$I_{EE}$	All outputs enabled		586		mA
$I_{TTO}$	Single channel enabled		16	18	mA
$I_{CC}$	Single channel enabled		173	214	mA
$I_{EE}$	Single channel enabled		205		mA
<b>LOGIC CHARACTERISTICS</b>					
Input High ( $V_{IH}$ )	$DV_{CC} = 3.3\text{ V}$	2.5			V
Input Low ( $V_{IL}$ )				1.0	V
Output High ( $V_{OH}$ )		2.5			V
Output Low ( $V_{OL}$ )				1.0	V
<b>THERMAL CHARACTERISTICS</b>					
Operating Temperature Range		-40		+85	°C
$\theta_{JA}$			22		°C/W

<sup>1</sup>  $V_{ICM}$  is the input common-mode voltage.

<sup>2</sup> Programmable via I<sup>2</sup>C.

<sup>3</sup> Assumes dc-coupled outputs. For ac-coupled outputs,  $I_{TTO}$  currents will double.

**TIMING SPECIFICATIONS**

**Table 2. I<sup>2</sup>C Timing Parameters**

Parameter	Min	Max	Unit	Description
f <sub>SCL</sub>	0	400	kHz	SCL clock frequency
t <sub>HD:STA</sub>	0.6	N/A	μs	Hold time for a start condition
t <sub>SU:STA</sub>	0.6	N/A	μs	Setup time for a repeated start condition
t <sub>LOW</sub>	1.3	N/A	μs	Low period of the SCL clock
t <sub>HIGH</sub>	0.6	N/A	μs	High period of the SCL clock
t <sub>HD:DAT</sub>	0	N/A	μs	Data hold time
t <sub>SU:DAT</sub>	10	N/A	ns	Data setup time
t <sub>r</sub>	1	300	ns	Rise time for both SDA and SCL
t <sub>f</sub>	1	300	ns	Fall time for both SDA and SCL
t <sub>SU:STO</sub>	0.6	N/A	μs	Setup time for a stop condition
t <sub>BUF</sub>	1	N/A	ns	Bus-free time between a stop and a start condition
C <sub>IO</sub>	5	7	Pf	Capacitance for each I/O pin

**I<sup>2</sup>C Timing Specifications**

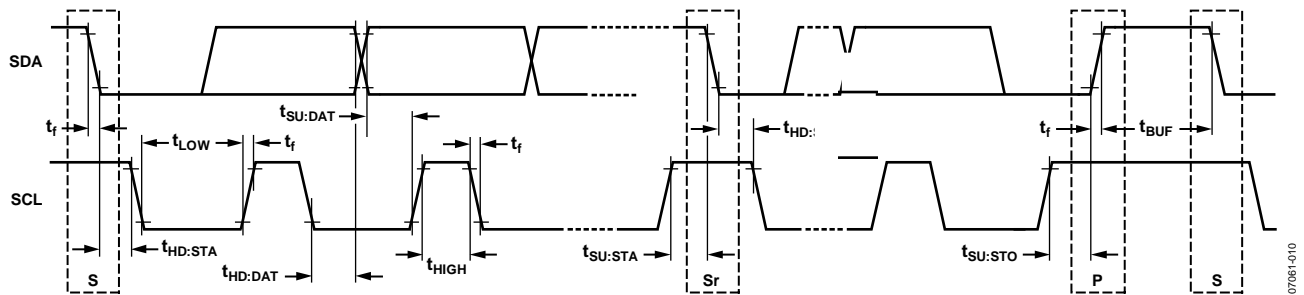

Figure 2. I<sup>2</sup>C Timing Diagram

## ABSOLUTE MAXIMUM RATINGS

Table 3.

Parameter	Rating
$V_{CC}$ to $V_{EE}$	3.7 V
$V_{TI}$	$V_{CC} + 0.6$ V
$V_{TO}$	$V_{CC} + 0.6$ V
Internal Power Dissipation	4.26 W
Differential Input Voltage	2.0 V
Logic Input Voltage	$V_{EE} - 0.3$ V < $V_{IN}$ < $V_{CC} + 0.6$ V
Storage Temperature Range	-65°C to +125°C
Lead Temperature	300°C

Stresses at or above those listed under Absolute Maximum Ratings may cause permanent damage to the product. This is a stress rating only; functional operation of the product at these or any other conditions above those indicated in the operational section of this specification is not implied. Operation beyond the maximum operating conditions for extended periods may affect product reliability.

### ESD CAUTION



**ESD (electrostatic discharge) sensitive device.** Charged devices and circuit boards can discharge without detection. Although this product features patented or proprietary protection circuitry, damage may occur on devices subjected to high energy ESD. Therefore, proper ESD precautions should be taken to avoid performance degradation or loss of functionality.

# PIN CONFIGURATION AND FUNCTION DESCRIPTIONS

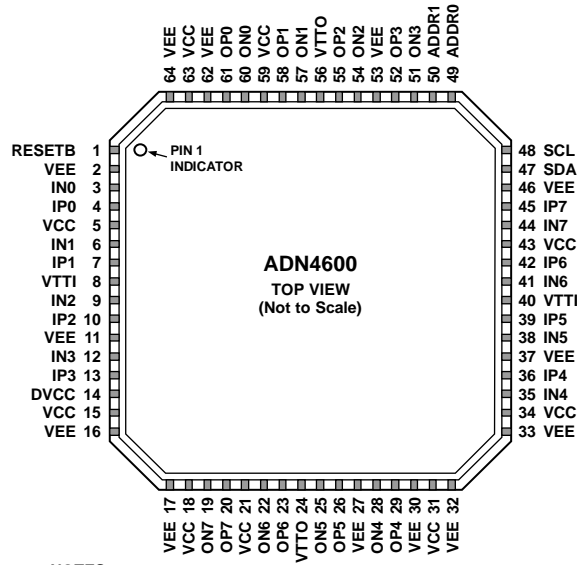

**NOTES**  
1. PAD ON BOTTOM OF PACKAGE MUST BE CONNECTED TO VEE.

Figure 3. Pin Configuration

Table 4. Pin Function Descriptions

Pin No.	Mnemonic	Type	Description
1	RESETB	Control	Reset Input (Active Low)
2, 11, 16, 17, 27, 30, 32, 33, 37, 46, 53, 62, 64	VEE	Power	Negative Supply
3, 6, 9, 12, 35, 38, 41, 44	IN0 to IN7	I/O	High Speed Inputs Complement
4, 7, 10, 13, 36, 39, 42, 45	IP0 to IP7	I/O	High Speed Inputs
5, 15, 18, 21, 31, 34, 43, 59, 63	VCC	Power	Positive Supply
8, 40	VTTI	Power	Input Termination Supply
14	DVCC	Power	Digital Positive Supply (3.3 V)
19, 22, 25, 28, 51, 54, 57, 60	ON7 to ON0	I/O	High Speed Outputs Complement
20, 23, 26, 29, 52, 55, 58, 61	OP7 to OP0	I/O	High Speed Outputs
24, 56	VTTO	Power	Output Termination Supply
47	SDA	Control	I <sup>2</sup> C Control Interface Data Input/Output
48	SCL	Control	I <sup>2</sup> C Control Interface Clock Input
49	ADDR0	Control	I <sup>2</sup> C Control Interface Address LSB
50	ADDR1	Control	I <sup>2</sup> C Control Interface Address MSB
	EPAD	Power	Connect to VEE

# TYPICAL PERFORMANCE CHARACTERISTICS

Figure 5 to Figure 8 were obtained using the standard test circuit shown in Figure 4.

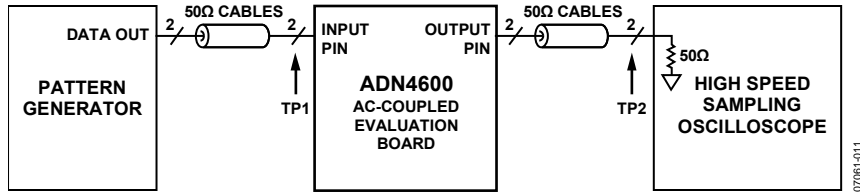

Figure 4. Standard Test Circuit (No Channel)

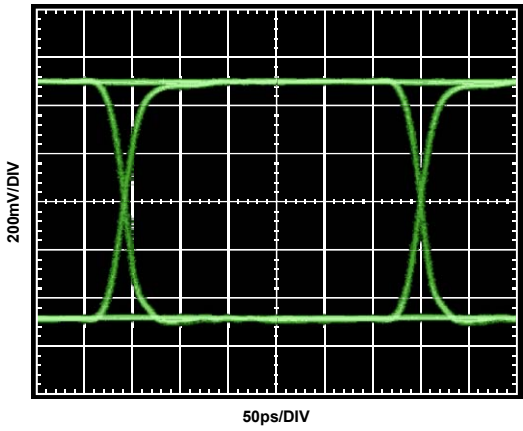

Figure 5. 3.25 Gbps Input Eye (TP1 from Figure 4)

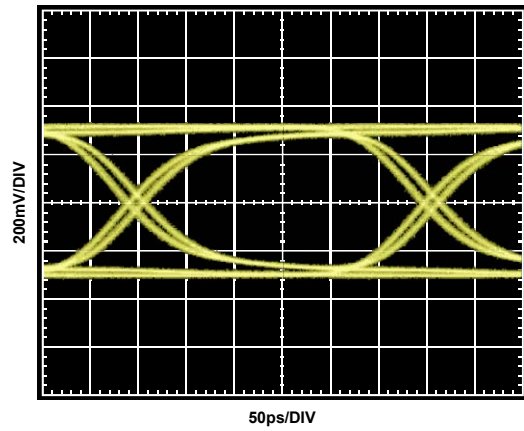

Figure 7. 3.25 Gbps Output Eye, No Channel (TP2 from Figure 4)

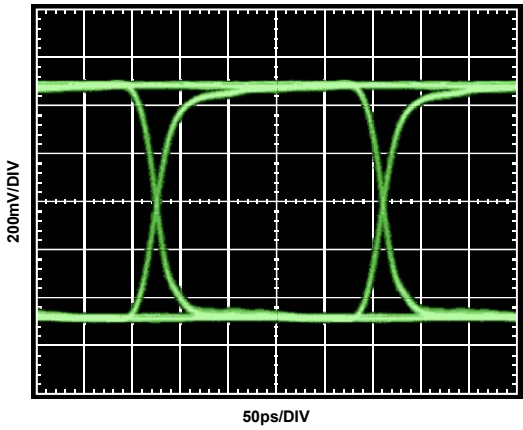

Figure 6. 4.25 Gbps Input Eye (TP1 from Figure 4)

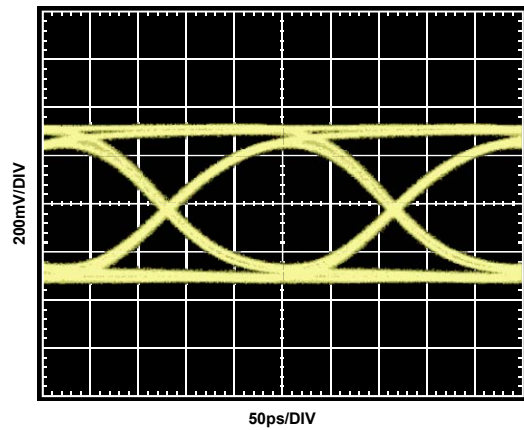

Figure 8. 4.25 Gbps Output Eye, No Channel (TP2 from Figure 4)



Figure 10 to Figure 13 were obtained using the standard test circuit shown in Figure 9.

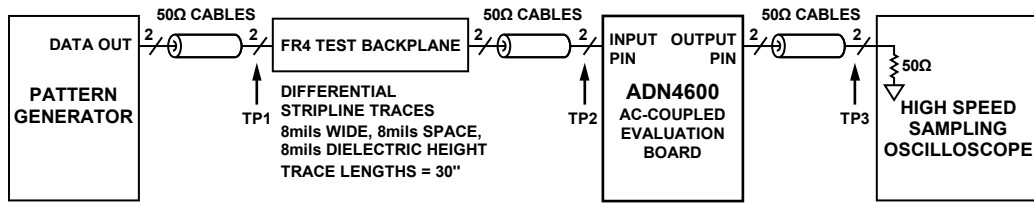

Figure 9. Input Equalization Test Circuit, FR4 (See Figure 5 and Figure 6 for the Reference Eye Diagrams at TP1)

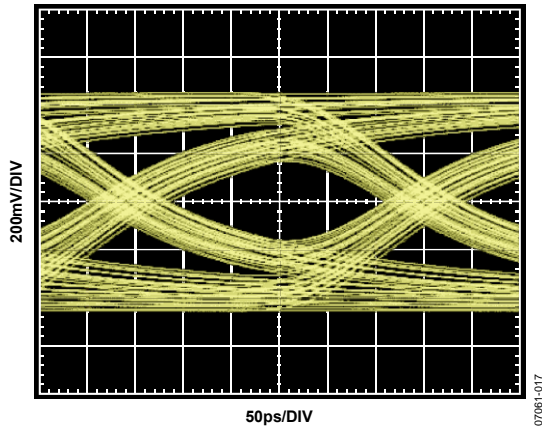

Figure 10. 3.25 Gbps Input Eye, 30 Inch FR4 Input Channel (TP2 from Figure 9)

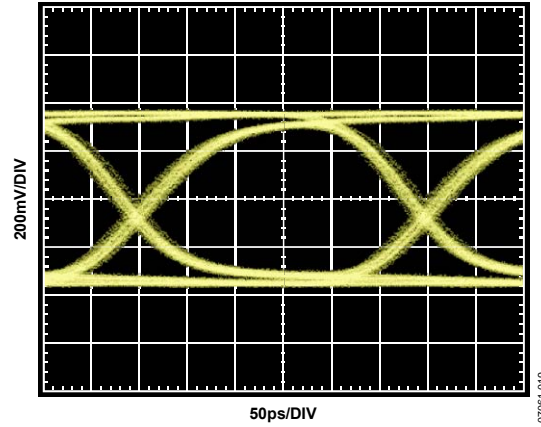

Figure 12. 3.25 Gbps Output Eye, 30 Inch FR4 Input Channel, Best EQ Setting (TP3 from Figure 9)

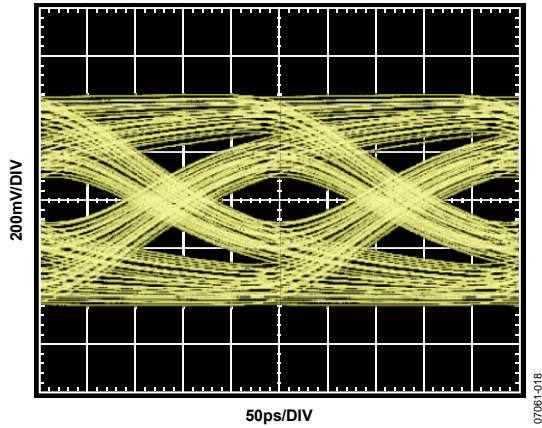

Figure 11. 4.25 Gbps Input Eye, 30 Inch FR4 Input Channel (TP2 from Figure 9)

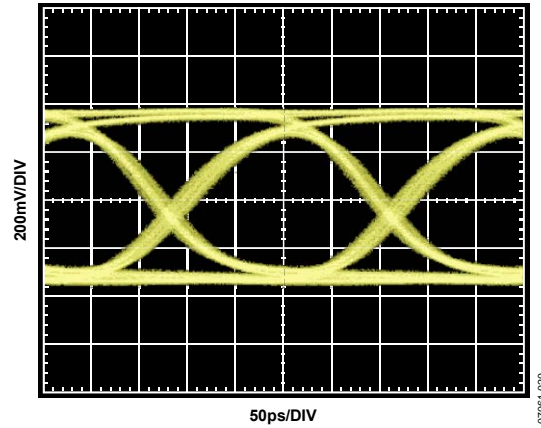

Figure 13. 4.25 Gbps Output Eye, 30 Inch FR4 Input Channel, Best EQ Setting (TP3 from Figure 9)

Figure 15 to Figure 18 were obtained using the standard test circuit shown in Figure 14.

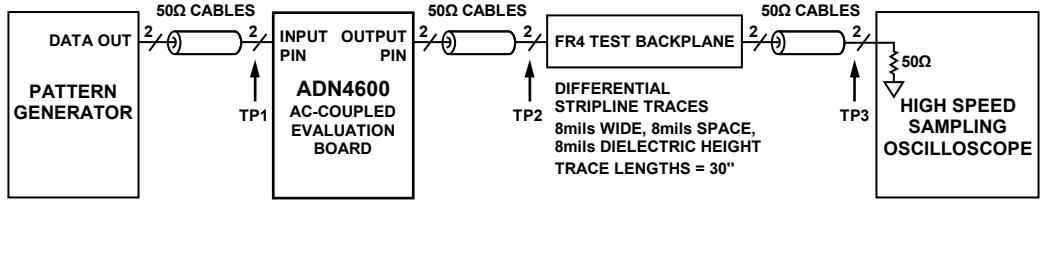

Figure 14. Output Pre-Emphasis Test Circuit, FR4

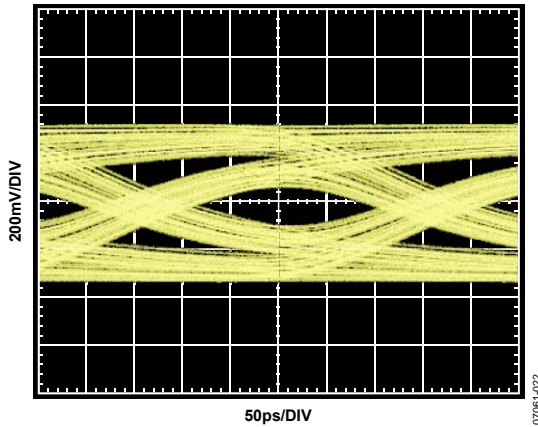

Figure 15. 3.25 Gbps Output Eye, 30 Inch FR4 Output Channel, PE = 0 (TP3 from Figure 14)

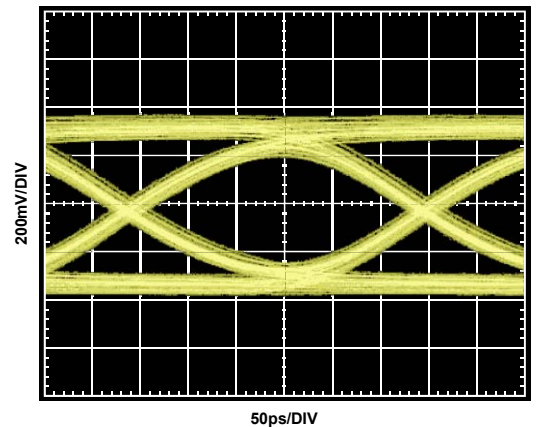

Figure 17. 3.25 Gbps Output Eye, 30 Inch FR4 Output Channel, PE = Best Setting (TP3 from Figure 14)

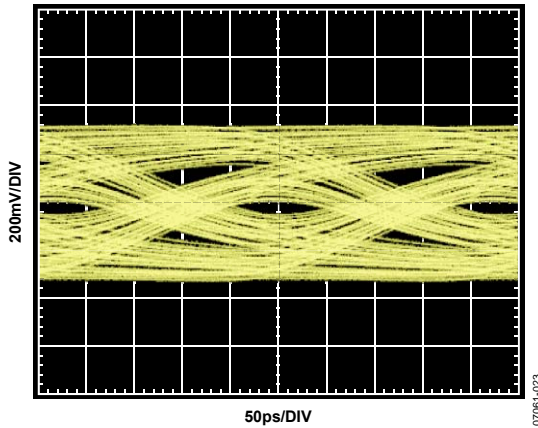

Figure 16. 4.25 Gbps Output Eye, 30 Inch FR4 Output Channel, PE = 0 (TP3 from Figure 14)

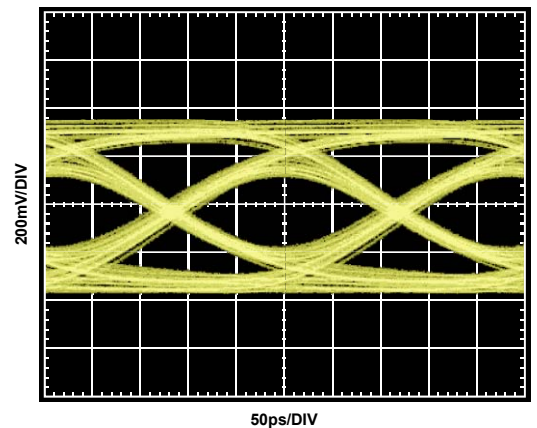

Figure 18. 4.25 Gbps Output Eye, 30 Inch FR4 Output Channel, PE = Best Setting (TP3 from Figure 14)

Test conditions:  $V_{CC} = 1.8\text{ V}$ ,  $V_{EE} = 0\text{ V}$ ,  $V_{TTI} = V_{TTO} = V_{CC}$ ,  $R_L = 50\ \Omega$ , differential output swing = 800 mV p-p differential,  $T_A = 25^\circ\text{C}$ , unless otherwise noted.

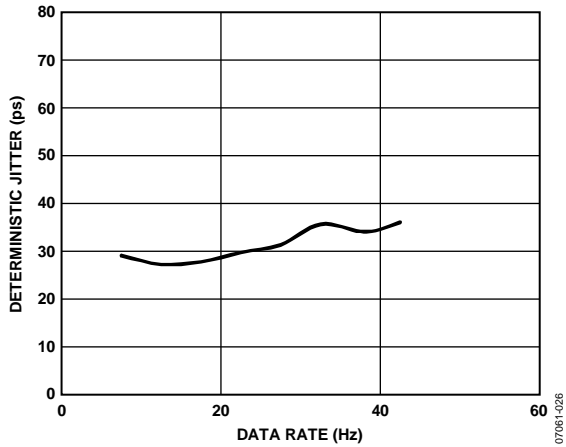

Figure 19. Deterministic Jitter vs. Data Rate

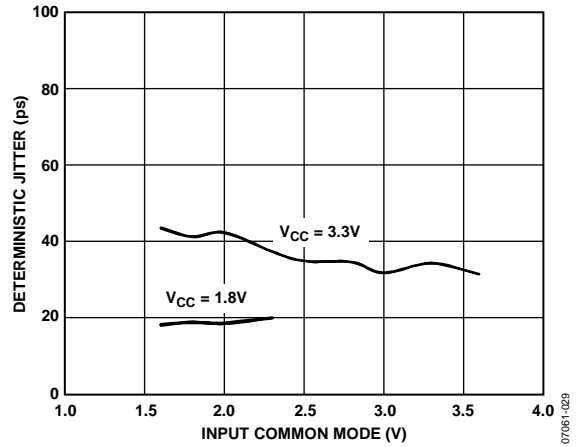

Figure 22. Deterministic Jitter vs. Input Common Mode

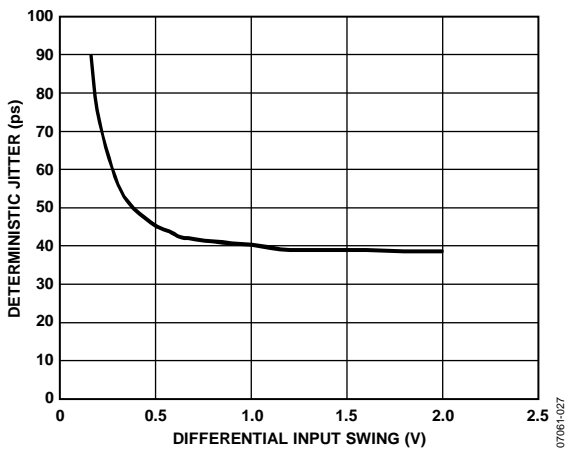

Figure 20. Deterministic Jitter vs. Input Swing

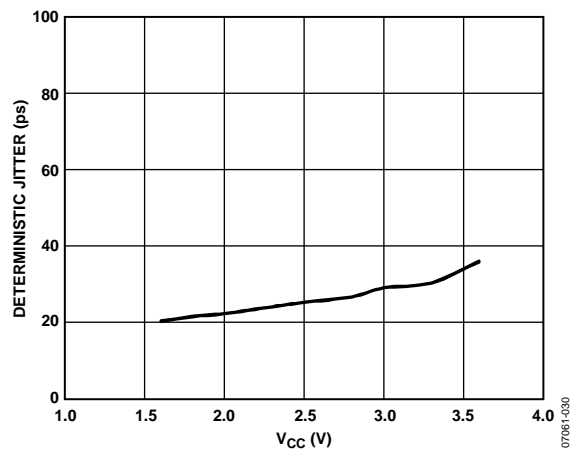

Figure 23. Deterministic Jitter vs. Supply Voltage

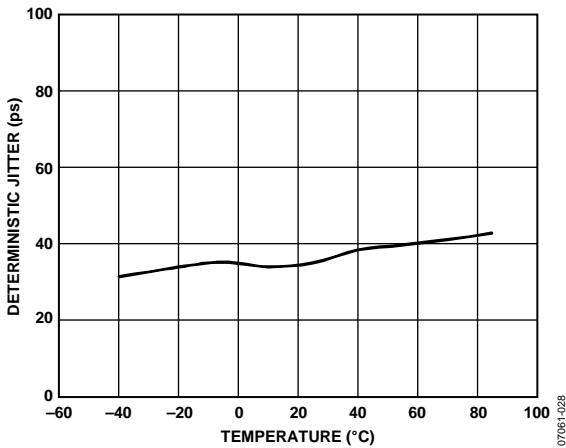

Figure 21. Deterministic Jitter vs. Temperature

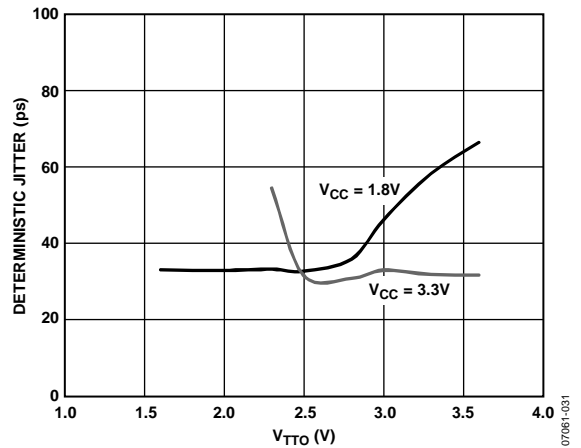

Figure 24. Deterministic Jitter vs. Output Termination Voltage

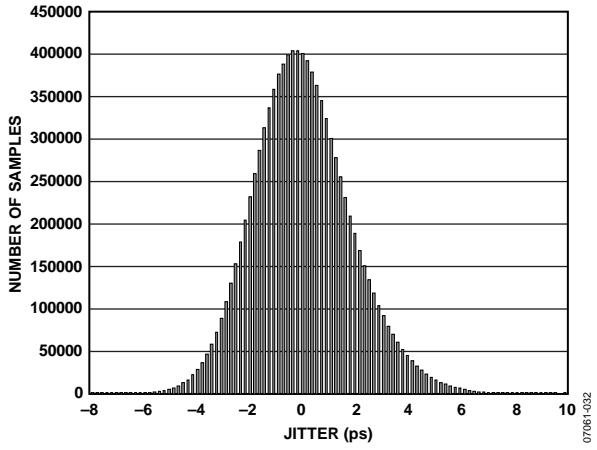

Figure 25. Random Jitter Histogram

07061-1032

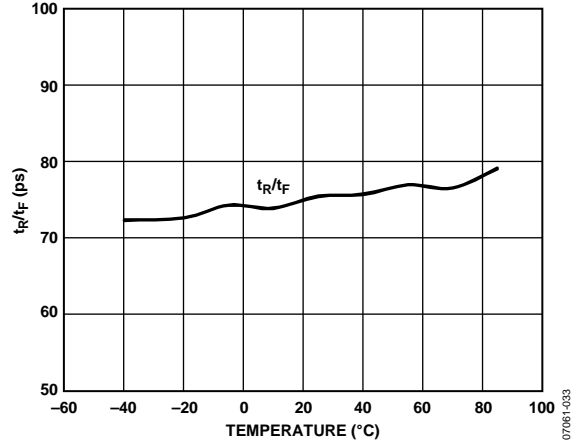

Figure 26. Rise Time/Fall Time vs. Temperature

07061-1033

# THEORY OF OPERATION

## INTRODUCTION

The **ADN4600** is an 8 × 8, buffered, asynchronous, 8-channel crosspoint switch that allows fully nonblocking connectivity between its transmitters and receivers. The switch supports multicast and broadcast operation, allowing the **ADN4600** to work in redundancy and port-replication applications.

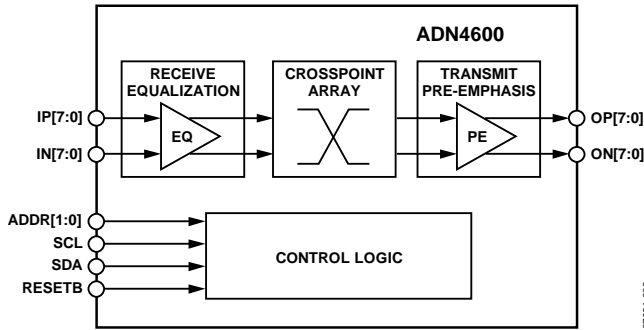

Figure 27. Simplified Functional Block Diagram

The **ADN4600** offers extensively programmable output levels and pre-emphasis, as well as a squelch function and the ability to fully disable the device. The receivers integrate a programmable, multizero transfer function that has been optimized to compensate either typical backplane or typical cable losses. The **ADN4600** provides a balanced, high speed switch core that maintains low channel-to-channel skew and preserves edge rates.

The I/O on-chip termination resistors are tied to user-settable supplies to support dc coupling in various logic styles. The **ADN4600** supports a wide core supply range;  $V_{CC}$  can be set from 1.8 V to 3.3 V. These features together with programmable transmitter output levels allow for several dc- and ac-coupled I/O configurations.

## RECEIVERS

### Input Structure and Input Levels

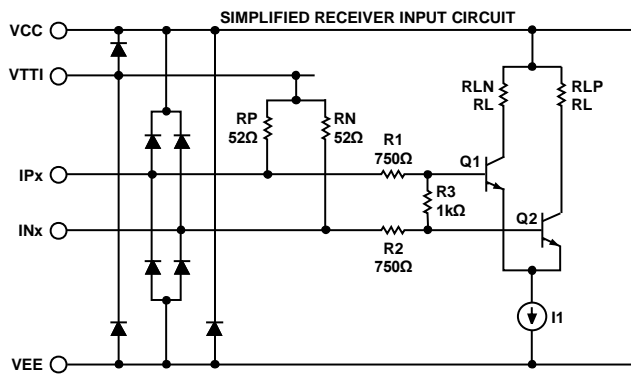

Figure 28. Simplified Input Structure

The **ADN4600** receiver inputs incorporate 50 Ω termination resistors, ESD protection, and a multizero transfer function equalizer that can be optimized for backplane and cable operation. Each receive channel also provides a positive/negative (P/N)

inversion function, which allows the user to swap the sign of the input signal path to eliminate the need for board-level crossovers in the receiver channel.

Table 5 illustrates some, but not all, possible combinations of input supply voltages.

### Equalization Settings

The **ADN4600** receiver incorporates a multizero transfer function with a continuous time equalizer, providing up to 22 dB of high-frequency boost at 2.25 GHz to compensate for up to 30 in. of FR4 at 4.25 Gbps. The **ADN4600** also allows independent control of the equalizer transfer function on each channel through the I<sup>2</sup>C control interface.

In the basic mode of operation, the equalizer transfer function allows independent control of the boost in two frequency ranges for optimal matching with the loss shape of the channel (for example, the shape due primarily to skin effect or to dielectric loss). The total equalizer shape space is reduced to two independent frequency response groups—one optimized for cable and the other optimized for FR4 material. The RX EQ bits of the RX[7:0] configuration registers provide eight settings for each frequency response group to ease programming for typical channels.

Table 6 summarizes the high-frequency boost for the frequency response grouping optimized for the FR4 material; it lists the basic control settings and the typical length of FR4 trace compensated for by each setting. All eight channels of the **ADN4600** use the FR4-optimized frequency response grouping by default. The user can override this default by setting the respective RX LUT select bit high and then selecting the frequency response grouping by setting the RX LUT FR4/CX4 bit high for FR4 and low for cable. Setting the RX EQBY bit of the RX[7:0] configuration registers high sets the equalization to 1.5 dB of boost, which compensates for 0 m to 2 m of CX4 or 0 in. to 10 in. of FR4.

In the advanced mode of operation, full control of the equalizer is available through the I<sup>2</sup>C control interface. The user can specify the boost in the midfrequency range and the boost in the high frequency range independently. This is accomplished by circumventing the frequency response groupings shown in Table 6 by setting the EQ CTL SRC bit (Bit 6 of the RX[7:0] EQ1 control registers) high and writing directly to the equalizer control bits on a per channel basis. Therefore, write values to Bits[5:0] of the RX[7:0] EQ1 control registers and to Bits[5:0] of the RX[7:0] EQ3 control registers for the channel of interest. The bits of these registers are ordered such that Bit 5 is a sign bit, and midlevel boost is centered around 0x00. Setting Bit 5 low and increasing the LSBs decreases the boost, whereas setting Bit 5 high and increasing the LSBs increases the boost.

Table 5. Common Input Voltage Levels

Configuration	V <sub>CC</sub> (V)	V <sub>TTI</sub> (V)
Low V <sub>TTI</sub> , AC-Coupled Input	1.8	1.6
Single 1.8 V Supply	1.8	1.8
3.3 V Core	3.3	1.8
Single 3.3 V Supply	3.3	3.3

Table 6. Receive Equalizer Boost vs. Setting

RX EQ Bit Settings	Boost (dB)	Typical FR4 Trace Length (Inches)
0	3.5	5 to 10
1	3.9	10 to 15
2	4.25	15 to 20
3	4.5	20 to 25
4	4.75	25 to 30
5	5.0	30 to 35
6	5.3	35 to 40
7	5.5	35 to 40

Table 7. Equalization Control Registers

Name	Addr	Bit 7	Bit 6	Bit 5	Bit 4	Bit 3	Bit 2	Bit 1	Bit 0	Default
RX[7:0] Configuration	0xB8, 0xB0, 0xA8, 0xA0, 0x98, 0x90, 0x88, 0x80		RX PNSWAP	RX EQBY	RX EN		RX EQ[2]	RX EQ[1]	RX EQ[0]	0x30
RX[7:0] EQ1 Control	0xBB, 0xB3, 0xAB, 0xA3, 0x9B, 0x93, 0x8B, 0x83		EQ CTL SRC	RX EQ1[5]	RX EQ1[4]	RX EQ1[3]	RX EQ1[2]	RX EQ1[1]	RX EQ1[0]	0x00
RX[7:0] EQ3 Control	0xBC, 0xB4, 0xAC, 0xA4, 0x9C, 0x94, 0x8C, 0x84			RX EQ3[5]	RX EQ3[4]	RX EQ3[3]	RX EQ3[2]	RX EQ3[1]	RX EQ3[0]	0x00
RX[7:0] FR4 Control	0xBD, 0xB5, 0xAD, 0xA5, 0x9D, 0x95, 0x8D, 0x85							RX LUT select	RX LUT FR4/CX4	0x00

### Lane Inversion

The receiver P/N inversion feature is a convenience intended to allow the user to implement the equivalent of a board-level crossover in a much smaller area and without additional via impedance discontinuities that degrade the high-frequency integrity of the signal path. The P/N inversion is independent

for each of the eight channels and is controlled through the I<sup>2</sup>C control interface.

### Warning

Using the lane inversion feature to account for signal inversions downstream of the receiver requires additional attention when switching connectivity.

## SWITCH CORE

The ADN4600 switch core is a fully nonblocking  $8 \times 8$  array that allows multicast and broadcast configurations. The configuration of the switch core is controlled through the I<sup>2</sup>C control interface. The control interface receives and stores the desired connection matrix for the eight input and eight output signal pairs. The interface consists of eight rows of double-rank latches, one for each output. The 2-bit data-word stored in these latches indicates to which (if any) of the eight inputs the output will be connected.

One output at a time can be preprogrammed by addressing the output and writing the desired connection data into the first rank of latches. This is done by writing to the XPT configuration register (Address 0x40). The output being addressed is written into Bits[2:0], and the input being sent to this output is written into Bits[6:4]. This process can be repeated until each of the

desired output changes has been preprogrammed. Bit 3 of the XPT configuration register (Address 0x40) signals whether a broadcast condition is desired. If this bit is set high, the input selected by Bits[6:4] is sent to all outputs. All output connections can then be programmed simultaneously by passing the data from the first rank of latches into the second rank by writing 0x01 to the XPT update register (Address 0x41). This is a self-clearing register and therefore always reads back as 0x00. The output connections always reflect the data programmed into the second rank of latches and do not change until the first rank of data is passed into the second rank by strobing the XPT update register.

If necessary for system verification, the data in the first rank of latches can be read back from the control interface. This is done by reading from the XPT Temp[3:0] registers, which show the status of the input data programmed in the first rank of latches for each output.

**Table 8. Switch Core Control and Status Registers**

Name	Addr	Bit 7	Bit 6	Bit 5	Bit 4	Bit 3	Bit 2	Bit 1	Bit 0	Default
XPT Configuration	0x40		IN PORT [2]	IN PORT [1]	IN PORT [0]	Broadcast	OUT PORT [2]	OUT PORT [1]	OUT PORT [0]	0x00
XPT Update	0x41								Update	0x00
XPT Status 0	0x50						OUT0[2]	OUT0[1]	OUT0[0]	N/A
XPT Status 1	0x51						OUT1[2]	OUT1[1]	OUT1[0]	N/A
XPT Status 2	0x52						OUT2[2]	OUT2[1]	OUT2[0]	N/A
XPT Status 3	0x53						OUT3[2]	OUT3[1]	OUT3[0]	N/A
XPT Status 4	0x54						OUT4[2]	OUT4[1]	OUT4[0]	N/A
XPT Status 5	0x55						OUT5[2]	OUT5[1]	OUT5[0]	N/A
XPT Status 6	0x56						OUT6[2]	OUT6[1]	OUT6[0]	N/A
XPT Status 7	0x57						OUT7[2]	OUT7[1]	OUT7[0]	N/A

**Table 9. Switch Core Temporary Registers**

Name	Addr	Bit 7	Bit 6	Bit 5	Bit 4	Bit 3	Bit 2	Bit 1	Bit 0	Default
XPT Temp 0	0x58		OUT1[2]	OUT1[1]	OUT1[0]		OUT0[2]	OUT0[1]	OUT0[0]	N/A
XPT Temp 1	0x59		OUT3[2]	OUT3[1]	OUT3[0]		OUT2[2]	OUT2[1]	OUT2[0]	N/A
XPT Temp 2	0x5A		OUT5[2]	OUT5[1]	OUT5[0]		OUT4[2]	OUT4[1]	OUT4[0]	N/A
XPT Temp 3	0x5B		OUT7[2]	OUT7[1]	OUT7[0]		OUT6[2]	OUT6[1]	OUT6[0]	N/A

**TRANSMITTERS**

**Output Structure and Output Levels**

The ADN4600 transmitter outputs incorporate 50 Ω termination resistors, ESD protection, and output current switch. Each channel provides independent control of both the absolute output level and the pre-emphasis output level. It should be noted that the choice of output level affects the output common-mode level. A 600 mV p-p differential output level with full pre-emphasis range requires an output termination voltage of 2.5 V or greater; therefore, for the VTTO pin, V<sub>CC</sub> must be equal to or greater than 2.5 V.

**Pre-Emphasis**

The total output amplitude and pre-emphasis setting space is reduced to a single map of basic settings that provides seven settings of output equalization to ease programming for typical channels. The full resolution of seven settings is available through the I<sup>2</sup>C interface by writing to Bits[2:0] (the TX PE[2:0] bits) of the TX[7:0] configuration registers. Table 10 summarizes the absolute output level, pre-emphasis level, and high frequency boost for each of the control settings and the typical length of FR4 trace compensated for by each setting.

Full control of the transmit output levels is available through the I<sup>2</sup>C control interface. This full control is achieved by writing to the TX[7:0] Output Level Control[1:0] registers for the channel of interest. The supported output levels are shown in Table 12. The TX[7:0] Output Level Control[1:0] registers must be programmed to one of the supported settings listed in this table; other settings are not supported.

The output equalization is optimized for less than 2.5 Gbps operation, but can be optimized for higher speed applications up to 4.25 Gbps through the I<sup>2</sup>C control interface by writing to the TX DATA RATE bit (Bit 4) of the TX[7:0] configuration register, with high representing 4.25 Gbps and low representing 2.5 Gbps. The TX[7:0] CTL SRC bit (Bit 7) in the TX[7:0] Output Level Control 1 register determines whether the pre-emphasis and output current controls for the channel of interest are selected from the optimized map or directly from the TX[7:0] Output Level Control[1:0] registers (per channel). Setting this bit high selects pre-emphasis control directly from the TX[7:0] Output Level Control[1:0] registers, and setting it low selects pre-emphasis control from the optimized map.

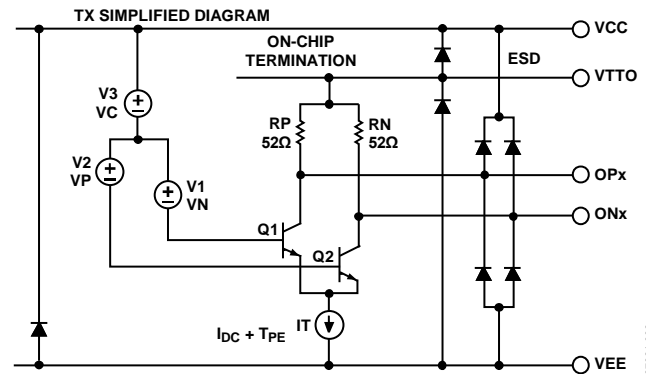

Figure 29. Simplified Output Structure

**Table 10. Transmit Pre-Emphasis Boost and Overshoot vs. Setting**

TX PE	Boost (dB)	Overshoot	DC Swing (mV p-p Differential)	Typical FR4 Trace Length (Inches)
0	0	0%	800	0 to 5
1	2	25%	800	0 to 5
2	3.5	50%	800	10 to 15
3	4.9	75%	800	15 to 20
4	6	100%	800	25 to 30
5	7.4	133%	600	30 to 35
6	9.5	200%	400	35 to 40

**Table 11. Transmitters Control Registers**

Name	Addr	Bit 7	Bit 6	Bit 5	Bit 4	Bit 3	Bit 2	Bit 1	Bit 0	Def.	
TX[7:0] Configuration	0xE0, 0xE8, 0xF0, 0xF8, 0xD8, 0xD0, 0xC8, 0xC0			TX EN	TX data rate		TX PE[2]	TX PE[1]	TX PE[0]	0x20	
TX[7:0] Output Level Control 1	0xE1, 0xE9, 0xF1, 0xF9, 0xD9, 0xD1, 0xC9, 0xC1	TX[7:0] CTL SRC	TX[7:0]_OLEV1[6:0]								0x40
TX[7:0] Output Level Control 0	0xE2, 0xEA, 0xF2, 0xFA, 0xDA, 0xD2, 0xCA, 0xC2		TX[7:0]_OLEV0[6:0]								0x40



Table 12. Output Level Programming

V <sub>OD</sub> (mV)	V <sub>D</sub> Peak (mV)	PE (dB)	I <sub>TOT</sub> (mA)	Tx[7:0] Output Level Control 0	Tx[7:0] Output Level Control 1
50	50	0.00	2	0x00	0x81
50	150	9.54	6	0x11	0x81
50	250	13.98	10	0x22	0x81
50	350	16.90	14	0x33	0x81
50	450	19.08	18	0x44	0x81
50	550	20.83	22	0x55	0x81
50	650	22.28	26	0x66	0x81
100	100	0.00	4	0x00	0x91
100	200	6.02	8	0x11	0x91
100	300	9.54	12	0x22	0x91
100	400	12.04	16	0x33	0x91
100	500	13.98	20	0x44	0x91
100	600	15.56	24	0x55	0x91
100	700	16.90	28	0x66	0x91
150	150	0.00	6	0x00	0x92
150	250	4.44	10	0x11	0x92
150	350	7.36	14	0x22	0x92
150	450	9.54	18	0x33	0x92
150	550	11.29	22	0x44	0x92
150	650	12.74	26	0x55	0x92
150	750	13.98	30	0x66	0x92
200	200	0.00	8	0x00	0xA2
200	300	3.52	12	0x11	0xA2
200	400	6.02	16	0x22	0xA2
200	500	7.96	20	0x33	0xA2
200	600	9.54	24	0x44	0xA2
200	700	10.88	28	0x55	0xA2
200	800	12.04	32	0x66	0xA2
250	250	0.00	10	0x00	0xA3
250	350	2.92	14	0x11	0xA3
250	450	5.11	18	0x22	0xA3
250	550	6.85	22	0x33	0xA3
250	650	8.30	26	0x44	0xA3
250	750	9.54	30	0x55	0xA3
250	850	10.63	34	0x66	0xA3
300	300	0.00	12	0x00	0xB3
300	400	2.50	16	0x11	0xB3
300	500	4.44	20	0x22	0xB3
300	600	6.02	24	0x33	0xB3
300	700	7.36	28	0x44	0xB3
300	800	8.52	32	0x55	0xB3
300	900	9.54	36	0x66	0xB3
350	350	0.00	14	0x00	0xB4
350	450	2.18	18	0x11	0xB4
350	550	3.93	22	0x22	0xB4
350	650	5.38	26	0x33	0xB4
350	750	6.62	30	0x44	0xB4
350	850	7.71	34	0x55	0xB4
350	950	8.67	38	0x66	0xB4
400	400	0.00	16	0x00	0xC4
400	500	1.94	20	0x11	0xC4
400	600	3.52	24	0x22	0xC4

V <sub>DD</sub> (mV)	V <sub>D</sub> Peak (mV)	PE (dB)	I <sub>TOT</sub> (mA)	Tx[7:0] Output Level Control 0	Tx[7:0] Output Level Control 1
400	700	4.86	28	0x33	0xC4
400	800	6.02	32	0x44	0xC4
400	900	7.04	36	0x55	0xC4
400	1000	7.96	40	0x66	0xC4
450	450	0.00	18	0x00	0xC5
450	550	1.74	22	0x11	0xC5
450	650	3.19	26	0x22	0xC5
450	750	4.44	30	0x33	0xC5
450	850	5.52	34	0x44	0xC5
450	950	6.49	38	0x55	0xC5
450	1050	7.36	42	0x66	0xC5
500	500	0.00	20	0x00	0xD5
500	600	1.58	24	0x11	0xD5
500	700	2.92	28	0x22	0xD5
500	800	4.08	32	0x33	0xD5
500	900	5.11	36	0x44	0xD5
500	1000	6.02	40	0x55	0xD5
500	1100	6.85	44	0x66	0xD5
550	550	0.00	22	0x00	0xD6
550	650	1.45	26	0x11	0xD6
550	750	2.69	30	0x22	0xD6
550	850	3.78	34	0x33	0xD6
550	950	4.75	38	0x44	0xD6
550	1050	5.62	42	0x55	0xD6
550	1150	6.41	46	0x66	0xD6
600	600	0.00	24	0x00	0xE6
600	700	1.34	28	0x11	0xE6
600	800	2.50	32	0x22	0xE6
600	900	3.52	36	0x33	0xE6
600	1000	4.44	40	0x44	0xE6
600	1100	5.26	44	0x55	0xE6
600	1200	6.02	48	0x66	0xE6
650	650	0.00	26	0x01	0xE6
650	750	1.24	30	0x12	0xE6
650	850	2.33	34	0x23	0xE6
650	950	3.30	38	0x34	0xE6
650	1050	4.17	42	0x45	0xE6
650	1150	4.96	46	0x56	0xE6
700	700	0.00	28	0x02	0xE6
700	800	1.16	32	0x13	0xE6
700	900	2.18	36	0x24	0xE6
700	1000	3.10	40	0x35	0xE6
700	1100	3.93	44	0x46	0xE6
750	750	0.00	30	0x03	0xE6
750	850	1.09	34	0x14	0xE6
750	950	2.05	38	0x25	0xE6
750	1050	2.92	42	0x36	0xE6
800	800	0.00	32	0x04	0xE6
800	900	1.02	36	0x15	0xE6
800	1000	1.94	40	0x26	0xE6
850	850	0.00	34	0x05	0xE6
850	950	0.97	38	0x16	0xE6
900	900	0.00	36	0x06	0xE6



Output Levels and Output Compliance						AC-Coupled Transmitter					DC-Coupled Transmitter					TxHeadroom = 0			TxHeadroom = 1	
V <sub>OD</sub> (mV)	I <sub>TOT</sub> (mA)	V <sub>D</sub> Peak (mV)	PE Boost	PE (dB)	dV <sub>OCM</sub> (mV)	V <sub>H</sub> (V)	V <sub>L</sub> (V)	V <sub>H</sub> Peak (V)	V <sub>L</sub> Peak (V)	dV <sub>OCM</sub> (mV)	V <sub>H</sub> (V)	V <sub>L</sub> (V)	V <sub>H</sub> Peak (V)	V <sub>L</sub> Peak (V)	Min V <sub>L</sub> (V)	Max V <sub>CC</sub> - V <sub>L</sub> (V)	Min V <sub>CC</sub> (V)	Min V <sub>L</sub> (V)	Max V <sub>CC</sub> - V <sub>L</sub> (V)	Min V <sub>CC</sub> (V)
V <sub>TTO</sub> and V <sub>CC</sub> = 1.8 V <sup>1</sup>																				
200	8	200	1.00	0.00	200	1.7	1.5	1.7	1.5	100	1.8	1.6	1.8	1.6	0.725	1.1	1.8	0.5	NA	NA
200	12	300	1.50	3.52	300	1.6	1.4	1.65	1.35	150	1.75	1.55	1.8	1.5	0.725	1.1	1.8	0.5	NA	NA
200	16	400	2.00	6.02	400	1.5	1.3	1.6	1.2	200	1.7	1.5	1.8	1.4	0.725	1.1	1.8	0.5	NA	NA
200	20	500	2.50	7.96	500	1.4	1.2	1.55	1.05	250	1.65	1.45	1.8	1.3	0.725	1.1	1.8	0.5	NA	NA
200	24	600	3.00	9.54	600	1.3	1.1	1.5	0.9	300	1.6	1.4	1.8	1.2	0.725	1.1	1.8	0.5	NA	NA
300	12	300	1.00	0.00	300	1.65	1.35	1.65	1.35	150	1.8	1.5	1.8	1.5	0.725	1.1	1.8	0.5	NA	NA
300	16	400	1.33	2.50	400	1.55	1.25	1.6	1.2	200	1.75	1.45	1.8	1.4	0.725	1.1	1.8	0.5	NA	NA
300	20	500	1.67	4.44	500	1.45	1.15	1.55	1.05	250	1.7	1.4	1.8	1.3	0.725	1.1	1.8	0.5	NA	NA
300	24	600	2.00	6.02	600	1.35	1.05	1.5	0.9	300	1.65	1.35	1.8	1.2	0.725	1.1	1.8	0.5	NA	NA
300	28	700	2.33	7.36	700	1.25	0.95	1.45	0.75	350	1.6	1.3	1.8	1.1	0.725	1.1	1.8	0.5	NA	NA
400	16	400	1.00	0.00	400	1.6	1.2	1.6	1.2	200	1.8	1.4	1.8	1.4	0.725	1.1	1.8	0.5	NA	NA
400	20	500	1.25	1.94	500	1.5	1.1	1.55	1.05	250	1.75	1.35	1.8	1.3	0.725	1.1	1.8	0.5	NA	NA
400	24	600	1.50	3.52	600	1.4	1	1.5	0.9	300	1.7	1.3	1.8	1.2	0.725	1.1	1.8	0.5	NA	NA
400	28	700	1.75	4.86	700	1.3	0.9	1.45	0.75	350	1.65	1.25	1.8	1.1	0.725	1.1	1.8	0.5	NA	NA
400	32	800	2.00	6.02	800	1.2	0.8	1.4	0.6	400	1.6	1.2	1.8	1	0.725	1.1	1.8	0.5	NA	NA
600	24	600	1.00	0.00	600	1.5	0.9	1.5	0.9	300	1.8	1.2	1.8	1.2	0.6	1.1	1.9	0.5	NA	NA

<sup>1</sup> TxHeadroom = 1 is not an option at V<sub>TTO</sub> and V<sub>CC</sub> = 1.8 V.

Table 14. Symbol Definitions for Output Levels vs. Setting

Symbol	Formula	Definition
V <sub>OD</sub>	$25 \Omega \times I_{DC}$	Peak differential output voltage
V <sub>ODPP</sub>	$25 \Omega \times I_{DC} \times 2 = 2 \times V_{OD}$	Peak-to-peak differential output voltage
dV <sub>OCM_DC-COUPLED</sub>	$25 \Omega \times I_{TX}/2 = V_{ODPP}/4 + (I_{PE}/2 \times 25)$	Output common-mode shift
dV <sub>OCM_AC-COUPLED</sub>	$50 \Omega \times I_{TX}/2 = V_{ODPP}/2 + (I_{PE}/2 \times 50)$	Output common-mode shift
I <sub>DC</sub>	$V_{OD}/R_{TERM}$	Output current that sets output level
I <sub>PE</sub>	–	Output current used for PE
I <sub>TX</sub>	$I_{DC} + I_{PE}$	Total transmitter output current
V <sub>H</sub>	$V_{TTO} - dV_{OCM} + V_{OD}/2$	Maximum single-ended output voltage
V <sub>L</sub>	$V_{TTO} - dV_{OCM} - V_{OD}/2$	Minimum single-ended output voltage

**Selective Squelch and Disable**

Each transmitter is equipped with disable and squelch controls. Disable is a full power-down state: all transmitter current, including output current, is reduced to 0 mA and the output pins are pulled up to VTTO, but there is a delay of approximately 1  $\mu$ s associated with re-enabling the transmitter. The output disable control is accessed through the TX EN bit (Bit 5) of the TX[7:0] configuration registers through the I<sup>2</sup>C control interface.

Squelch simply reduces the output current to submicroamp levels, allowing both output pins to pull up to VTTO through

the output termination resistors. The transmitter recovers from squelch in less than 100 ns.

The output squelch and the output disable control can both be accessed through the TX[7:0] squelch control registers, with the top nibble representing the squelch control and the bottom nibble representing the output disable for one channel. The channels are disabled or squelched by writing 0s to the corresponding nibbles. The channels are enabled by writing all 1s, which is the default setting. For example, to squelch channel TX0, Register 0xC3 must be set to 0x0F. The entire nibble must be written to all 0s for this functionality.

**Table 15. Transmitters Squelch Control Registers**

Name	Addr	Bit 7	Bit 6	Bit 5	Bit 4	Bit 3	Bit 2	Bit 1	Bit 0	Default
TX[7:0] Squelch Control	0xE3, 0xEB, 0xF3, 0xFB, 0xDB, 0xD3, 0xCB, 0xC3	SQUELCHb[3:0]				DISABLEb[3:0]				0xFF

## I<sup>2</sup>C CONTROL INTERFACE

### Serial Interface General Functionality

The ADN4600 register set is controlled through a 2-wire I<sup>2</sup>C interface. The ADN4600 acts only as an I<sup>2</sup>C slave device. Therefore, the I<sup>2</sup>C bus in the system needs to include an I<sup>2</sup>C master to configure the ADN4600 and other I<sup>2</sup>C devices that may be on the bus. Data transfers are controlled by the two I<sup>2</sup>C wires: the SCL input clock pin and the SDA bidirectional data pin.

The ADN4600 I<sup>2</sup>C interface can be run in the standard (100 kHz) and fast (400 kHz) modes. The SDA line only changes value when the SCL pin is low, with two exceptions: the SDA pin is driven low while the SCL pin is high to indicate the beginning or continuation of a transfer, and the SDA line is driven high while the SCL line is high to indicate the end of a transfer. Therefore, it is important to control the SCL clock to toggle only when the SDA line is stable, unless indicating a start, repeated start, or stop condition.

### I<sup>2</sup>C Interface Data Transfers: Data Write

To write data to the ADN4600 register set, a microcontroller (or any other I<sup>2</sup>C master) needs to send the appropriate control signals to the ADN4600 slave device. Use the following steps, where the signals are controlled by the I<sup>2</sup>C master unless otherwise specified. A diagram of the procedure is shown in Figure 31.

1. Send a start condition (that is, while holding the SCL line high, pull the SDA line low).
2. Send the ADN4600 part address (seven bits), whose upper five bits are the static value b10010 and whose lower two bits are controlled by the ADDR1 and ADDR0 input pins. This transfer should be MSB first.
3. Send the write indicator bit (0).
4. Wait for the ADN4600 to acknowledge the request.
5. Send the register address (eight bits) to which data is to be written. This transfer should be MSB first.
6. Wait for the ADN4600 to acknowledge the request.

7. Send the data (eight bits) to be written to the register whose address was set in Step 5. This transfer should be MSB first.
8. Wait for the ADN4600 to acknowledge the request.
9. Send a stop condition (that is, while holding the SCL line high, pull the SDA line high) and release control of the bus.
10. Send a repeated start condition (that is, while holding the SCL line high, pull the SDA line low) and continue with Step 2 in this procedure to perform another write.
11. Send a repeated start condition (that is, while holding the SCL line high, pull the SDA line low) and continue with Step 2 of the read procedure (see the I<sup>2</sup>C Interface Data Transfers: Data Read section) to perform a read from another address.
12. Send a repeated start condition (that is, while holding the SCL line high, pull the SDA line low) and continue with Step 8 of the read procedure (in the I<sup>2</sup>C Interface Data Transfers: Data Read section) to perform a read from the same address set in Step 5 of the write procedure.

In Figure 31, the ADN4600 write process is shown. The SCL signal is shown, along with a general write operation and a specific example. In the example, Data 0x92 is written to Register Address 0x6D of an ADN4600 part with a slave address of 0x4B. The slave address is seven bits wide. The upper five bits of the slave address are internally set to b10010. The lower two bits are controlled by the ADDR[1:0] pins. In this example, the bits controlled by the ADDR[1:0] pins are set to b11. In the figure, the corresponding step number is visible in the circle under the waveform. The SCL line is driven by the I<sup>2</sup>C master, not by the ADN4600 slave. As for the SDA line, the data in the shaded polygons of Figure 31 is driven by the ADN4600, whereas the data in the nonshaded polygons is driven by the I<sup>2</sup>C master. The end phase case shown corresponds with Step 9.

It is important to note that the SDA line only changes when the SCL line is low, except when a start, stop, or repeated start condition is being sent, as is the case in Step 1 and Step 9.

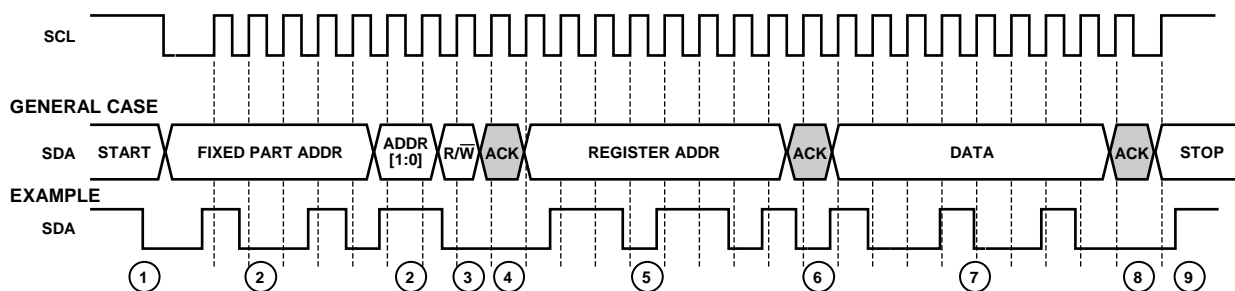

Figure 31. I<sup>2</sup>C Write Diagram

0705-008

**I<sup>2</sup>C Interface Data Transfers: Data Read**

To read data from the ADN4600 register set, a microcontroller (or any other I<sup>2</sup>C master) needs to send the appropriate control signals to the ADN4600 slave device. Use the following steps, where the signals are controlled by the I<sup>2</sup>C master unless otherwise specified. A diagram of the procedure is shown in Figure 32.

1. Send a start condition (that is, while holding the SCL line high, pull the SDA line low).
2. Send the ADN4600 part address (seven bits), whose upper five bits are the static value b10010 and whose lower two bits are controlled by the ADDR1 and ADDR0 input pins. This transfer should be MSB first.
3. Send the write indicator bit (0).
4. Wait for the ADN4600 to acknowledge the request.
5. Send the register address (eight bits) from which data is to be read. This transfer should be MSB first. The register address is kept in the ADN4600 memory until the part is reset or the register address is written over with the same procedure (Step 1 to Step 6 of the write procedure; see the I<sup>2</sup>C Interface Data Transfers: Data Write section).
6. Wait for the ADN4600 to acknowledge the request.
7. Send a repeated start condition (that is, while holding the SCL line high, pull the SDA line low).
8. Send the ADN4600 part address (seven bits), whose upper five bits are the static value b10010 and whose lower two bits are controlled by the ADDR1 and ADDR0 input pins. This transfer should be MSB first.
9. Send the read indicator bit (1).
10. Wait for the ADN4600 to acknowledge the request.
11. The ADN4600 then serially transfers the data (eight bits) held in the register indicated by the address set in Step 5.
12. Acknowledge the data.
13. Send a stop condition (that is, while holding the SCL line high, pull the SDA line high) and release control of the bus.

14. Send a repeated start condition (that is, while holding the SCL line high, pull the SDA line low) and continue with Step 2 of the write procedure (see the I<sup>2</sup>C Interface Data Transfers: Data Write section) to perform a write.
15. Send a repeated start condition (that is, while holding the SCL line high, pull the SDA line low) and continue with Step 2 of the read procedure to perform a read from a another address.
16. Send a repeated start condition (that is, while holding the SCL line high, pull the SDA line low) and continue with Step 8 of the read procedure to perform a read from the same address.

In Figure 32, the ADN4600 read process is shown. The SCL signal is shown, along with a general read operation and a specific example. In the example, Data 0x49 is read from Register Address 0x6D of an ADN4600 part with a slave address of 0x4B. The part address is seven bits wide. The upper five bits of the slave address are internally set to b10010. The lower two bits are controlled by the ADDR[1:0] pins. In this example, the bits controlled by the ADDR[1:0] pins are set to b11. In Figure 32, the corresponding step number is visible in the circle under the waveform. The SCL line is driven by the I<sup>2</sup>C master, not by the ADN4600 slave. As for the SDA line, the data in the shaded polygons of Figure 32 is driven by the ADN4600, whereas the data in the nonshaded polygons is driven by the I<sup>2</sup>C master. The end phase case shown corresponds with Step 13.

It is important to note that the SDA line only changes when the SCL line is low, except when a start, stop, or repeated start condition is being sent, as is the case in Step 1, Step 7, and Step 13. In Figure 32, Sr represents a repeated start where the SDA line is brought high before SCL is raised. SDA is then dropped while SCL is still high.

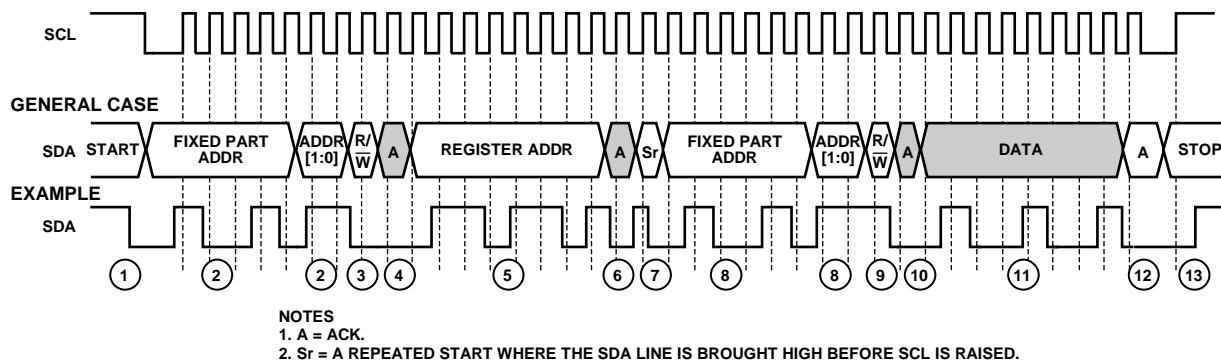

Figure 32. I<sup>2</sup>C Read Diagram

## PCB DESIGN GUIDELINES

Proper RF PCB design techniques must be used for optimal performance.

### **Power Supply Connections and Ground Planes**

Use of one low impedance ground plane is recommended. The VEE pins should be soldered directly to the ground plane to reduce series inductance. If the ground plane is an internal plane and connections to the ground plane are made through vias, multiple vias can be used in parallel to reduce the series inductance. The exposed pad should be connected to the VEE plane using plugged vias so that solder does not leak through the vias during reflow.

Use of a 10  $\mu\text{F}$  electrolytic capacitor between VCC and VEE is recommended at the location where the 3.3 V supply enters the PCB. It is recommended that 0.1  $\mu\text{F}$  and 1 nF ceramic chip capacitors be placed in parallel at each supply pin for high frequency power supply decoupling. When using 0.1  $\mu\text{F}$  and 1 nF ceramic chip capacitors, they should be placed between the IC power supply pins (VCC, VTTI, VTTO) and VEE, as close as possible to the supply pins.

By using adjacent power supply and GND planes, excellent high frequency decoupling can be attained by using close spacing between the planes. This capacitance is given by

$$C_{\text{PLANE}} = 0.88\epsilon_r A/d \text{ (pF)}$$

where:

$\epsilon_r$  is the dielectric constant of the PCB material.

$A$  is the area of the overlap of power and GND planes ( $\text{cm}^2$ ).

$d$  is the separation between planes (mm).

For FR4,  $\epsilon_r = 4.4$  and 0.25 mm spacing,  $C \sim 15 \text{ pF/cm}^2$ .

## **Transmission Lines**

Use of 50  $\Omega$  transmission lines is required for all high frequency input and output signals to minimize reflections. It is also necessary for the high speed pairs of differential input traces, as well as the high speed pairs of differential output traces, to be matched in length to avoid skew between the differential traces.

### **Soldering Guidelines for Chip Scale Package**

The lands on the LFCSP are rectangular. The printed circuit board pad for these should be 0.1 mm longer than the package land length and 0.05 mm wider than the package land width. The land should be centered on the pad. This ensures that the solder joint size is maximized. The bottom of the chip scale package has a central exposed pad. The pad on the printed circuit board should be at least as large as this exposed pad. The user must connect the exposed pad to VEE using plugged vias so that solder does not leak through the vias during reflow. This ensures a solid connection from the exposed pad to VEE.



## CONTROL REGISTER MAP

Table 16. Basic Mode I<sup>2</sup>C Register Definitions

Addr (Hex)	Name	Bit 7	Bit 6	Bit 5	Bit 4	Bit 3	Bit 2	Bit 1	Bit 0	Default
0x00	Reset								Reset	
0x40	XPT Configuration		IN PORT[2]	IN PORT[1]	IN PORT[0]	Broadcast	OUT PORT[2]	OUT PORT[1]	OUT PORT[0]	0x00
0x41	XPT Update								Update	0x00
0x50	XPT Status 0						OUT0[2]	OUT0[1]	OUT0[0]	
0x51	XPT Status 1						OUT1[2]	OUT1[1]	OUT1[0]	
0x52	XPT Status 2						OUT2[2]	OUT2[1]	OUT2[0]	
0x53	XPT Status 3						OUT3[2]	OUT3[1]	OUT3[0]	
0x54	XPT Status 4						OUT4[2]	OUT4[1]	OUT4[0]	
0x55	XPT Status 5						OUT5[2]	OUT5[1]	OUT5[0]	
0x56	XPT Status 6						OUT6[2]	OUT6[1]	OUT6[0]	
0x57	XPT Status 7						OUT7[2]	OUT7[1]	OUT7[0]	
0x58	XPT Temp 0		OUT1[2]	OUT1[1]	OUT1[0]		OUT0[2]	OUT0[1]	OUT0[0]	
0x59	XPT Temp 1		OUT3[2]	OUT3[1]	OUT3[0]		OUT2[2]	OUT2[1]	OUT2[0]	
0x5A	XPT Temp 2		OUT5[2]	OUT5[1]	OUT5[0]		OUT4[2]	OUT4[1]	OUT4[0]	
0x5B	XPT Temp 3		OUT7[2]	OUT7[1]	OUT7[0]		OUT6[2]	OUT6[1]	OUT6[0]	
0x80	RX0 Configuration		RX PNSWAP	RX EQBY	RX EN		RX EQ[2]	RX EQ[1]	RX EQ[0]	0x30
0x88	RX1 Configuration		RX PNSWAP	RX EQBY	RX EN		RX EQ[2]	RX EQ[1]	RX EQ[0]	0x30
0x90	RX2 Configuration		RX PNSWAP	RX EQBY	RX EN		RX EQ[2]	RX EQ[1]	RX EQ[0]	0x30
0x98	RX3 Configuration		RX PNSWAP	RX EQBY	RX EN		RX EQ[2]	RX EQ[1]	RX EQ[0]	0x30
0xA0	RX4 Configuration		RX PNSWAP	RX EQBY	RX EN		RX EQ[2]	RX EQ[1]	RX EQ[0]	0x30
0xA8	RX5 Configuration		RX PNSWAP	RX EQBY	RX EN		RX EQ[2]	RX EQ[1]	RX EQ[0]	0x30
0xB0	RX6 Configuration		RX PNSWAP	RX EQBY	RX EN		RX EQ[2]	RX EQ[1]	RX EQ[0]	0x30
0xB8	RX7 Configuration		RX PNSWAP	RX EQBY	RX EN		RX EQ[2]	RX EQ[1]	RX EQ[0]	0x30
0xC0	TX0 Configuration			TX EN	TX data rate		TX PE[2]	TX PE[1]	TX PE[0]	0x20
0xC8	TX1 Configuration			TX EN	TX data rate		TX PE[2]	TX PE[1]	TX PE[0]	0x20
0xD0	TX2 Configuration			TX EN	TX data rate		TX PE[2]	TX PE[1]	TX PE[0]	0x20
0xD8	TX3 Configuration			TX EN	TX data rate		TX PE[2]	TX PE[1]	TX PE[0]	0x20
0xE0	TX4 Configuration			TX EN	TX data rate		TX PE[2]	TX PE[1]	TX PE[0]	0x20
0xE8	TX5 Configuration			TX EN	TX data rate		TX PE[2]	TX PE[1]	TX PE[0]	0x20
0xF0	TX6 Configuration			TX EN	TX data rate		TX PE[2]	TX PE[1]	TX PE[0]	0x20
0xF8	TX7 Configuration			TX EN	TX data rate		TX PE[2]	TX PE[1]	TX PE[0]	0x20

Table 17. Advanced Mode I<sup>2</sup>C Register Definitions

Addr (Hex)	Name	Bit 7	Bit 6	Bit 5	Bit 4	Bit 3	Bit 2	Bit 1	Bit 0	Default	
0x23	TxHeadroom	TxH_B3	TxH_B2	TxH_B1	TxH_B0	TxH_A3	TxH_A2	TxH_A1	TxH_A0	0x00	
0x83	RX0 EQ1 Control		EQ CTL SRC	RX EQ1[5]	RX EQ1[4]	RX EQ1[3]	RX EQ1[2]	RX EQ1[1]	RX EQ1[0]	0x00	
0x84	RX0 EQ3 Control			RX EQ3[5]	RX EQ3[4]	RX EQ3[3]	RX EQ3[2]	RX EQ3[1]	RX EQ3[0]	0x00	
0x85	RX0 FR4 Control							RX LUT select	RX LUT FR4/CX4	0x00	
0x8B	RX1 EQ1 Control		EQ CTL SRC	RX EQ1[5]	RX EQ1[4]	RX EQ1[3]	RX EQ1[2]	RX EQ1[1]	RX EQ1[0]	0x00	
0x8C	RX1 EQ3 Control			RX EQ3[5]	RX EQ3[4]	RX EQ3[3]	RX EQ3[2]	RX EQ3[1]	RX EQ3[0]	0x00	
0x8D	RX1 FR4 Control							RX LUT select	RX LUT FR4/CX4	0x00	
0x93	RX2 EQ1 Control		EQ CTL SRC	RX EQ1[5]	RX EQ1[4]	RX EQ1[3]	RX EQ1[2]	RX EQ1[1]	RX EQ1[0]	0x00	
0x94	RX2 EQ3 Control			RX EQ3[5]	RX EQ3[4]	RX EQ3[3]	RX EQ3[2]	RX EQ3[1]	RX EQ3[0]	0x00	
0x95	RX2 FR4 Control							RX LUT select	RX LUT FR4/CX4	0x00	
0x9B	RX3 EQ1 Control		EQ CTL SRC	RX EQ1[5]	RX EQ1[4]	RX EQ1[3]	RX EQ1[2]	RX EQ1[1]	RX EQ1[0]	0x00	
0x9C	RX3 EQ3 Control			RX EQ3[5]	RX EQ3[4]	RX EQ3[3]	RX EQ3[2]	RX EQ3[1]	RX EQ3[0]	0x00	
0x9D	RX3 FR4 Control							RX LUT select	RX LUT FR4/CX4	0x00	
0xA3	RX4 EQ1 Control		EQ CTL SRC	RX EQ1[5]	RX EQ1[4]	RX EQ1[3]	RX EQ1[2]	RX EQ1[1]	RX EQ1[0]	0x00	
0xA4	RX4 EQ3 Control			RX EQ3[5]	RX EQ3[4]	RX EQ3[3]	RX EQ3[2]	RX EQ3[1]	RX EQ3[0]	0x00	
0xA5	RX4 FR4 Control							RX LUT select	RX LUT FR4/CX4	0x00	
0xAB	RX5 EQ1 Control		EQ CTL SRC	RX EQ1[5]	RX EQ1[4]	RX EQ1[3]	RX EQ1[2]	RX EQ1[1]	RX EQ1[0]	0x00	
0xAC	RX5 EQ3 Control			RX EQ3[5]	RX EQ3[4]	RX EQ3[3]	RX EQ3[2]	RX EQ3[1]	RX EQ3[0]	0x00	
0xAD	RX5 FR4 Control							RX LUT select	RX LUT FR4/CX4	0x00	
0xB3	RX6 EQ1 Control		EQ CTL SRC	RX EQ1[5]	RX EQ1[4]	RX EQ1[3]	RX EQ1[2]	RX EQ1[1]	RX EQ1[0]	0x00	
0xB4	RX6 EQ3 Control			RX EQ3[5]	RX EQ3[4]	RX EQ3[3]	RX EQ3[2]	RX EQ3[1]	RX EQ3[0]	0x00	
0xB5	RX6 FR4 Control							RX LUT select	RX LUT FR4/CX4	0x00	
0xBB	RX7 EQ1 Control		EQ CTL SRC	RX EQ1[5]	RX EQ1[4]	RX EQ1[3]	RX EQ1[2]	RX EQ1[1]	RX EQ1[0]	0x00	
0xBC	RX7 EQ3 Control			RX EQ3[5]	RX EQ3[4]	RX EQ3[3]	RX EQ3[2]	RX EQ3[1]	RX EQ3[0]	0x00	
0xBD	RX7 FR4 Control							RX LUT select	RX LUT FR4/CX4	0x00	
0xC1	TX0 Output Level Control 1	TX0 CTL SRC	TX0_OLEV1[6:0]								0x40
0xC2	TX0 Output Level Control 0		TX0_OLEV0[6:0]								0x40
0xC3	TX0 Squelch Control	SQUELChb[3:0]				DISABLEb[3:0]					0xFF
0xC9	TX1 Output Level Control 1	TX1 CTL SRC	TX1_OLEV1[6:0]								0x40
0xCA	TX1 Output Level Control 0		TX1_OLEV0[6:0]								0x40
0xCB	TX1 Squelch Control	SQUELChb[3:0]				DISABLEb[3:0]					0xFF

Addr (Hex)	Name	Bit 7	Bit 6	Bit 5	Bit 4	Bit 3	Bit 2	Bit 1	Bit 0	Default	
0xD1	TX2 Output Level Control 1	TX2 CTL SRC				TX2_OLEV1[6:0]					0x40
0xD2	TX2 Output Level Control 0					TX2_OLEV0[6:0]					0x40
0xD3	TX2 Squelch Control	SQUELCHb[3:0]			DISABLEb[3:0]					0xFF	
0xD9	TX3 Output Level Control 1	TX3 CTL SRC				TX3_OLEV1[6:0]					0x40
0xDA	TX3 Output Level Control 0					TX3_OLEV0[6:0]					0x40
0xDB	TX3 Squelch Control	SQUELCHb[3:0]			DISABLEb[3:0]					0xFF	
0xE1	TX7 Output Level Control 1	TX7 CTL SRC				TX7_OLEV1[6:0]					0x40
0xE2	TX7 Output Level Control 0					TX7_OLEV0[6:0]					0x40
0xE3	TX7 Squelch Control	SQUELCHb[3:0]			DISABLEb[3:0]					0xFF	
0xE9	TX6 Output Level Control 1	TX6 CTL SRC				TX6_OLEV1[6:0]					0x40
0xEA	TX6 Output Level Control 0					TX6_OLEV0[6:0]					0x40
0xEB	TX6 Squelch Control	SQUELCHb[3:0]			DISABLEb[3:0]					0xFF	
0xF1	TX5 Output Level Control 1	TX5 CTL SRC				TX5_OLEV1[6:0]					0x40
0xF2	TX5 Output Level Control 0					TX5_OLEV0[6:0]					0x40
0xF3	TX5 Squelch Control	SQUELCHb[3:0]			DISABLEb[3:0]					0xFF	
0xF9	TX4 Output Level Control 1	TX4 CTL SRC				TX4_OLEV1[6:0]					0x40
0xFA	TX4 Output Level Control 0					TX4_OLEV0[6:0]					0x40
0xFB	TX4 Squelch Control	SQUELCHb[3:0]			DISABLEb[3:0]					0xFF	

PACKAGE OUTLINE DIMENSIONS

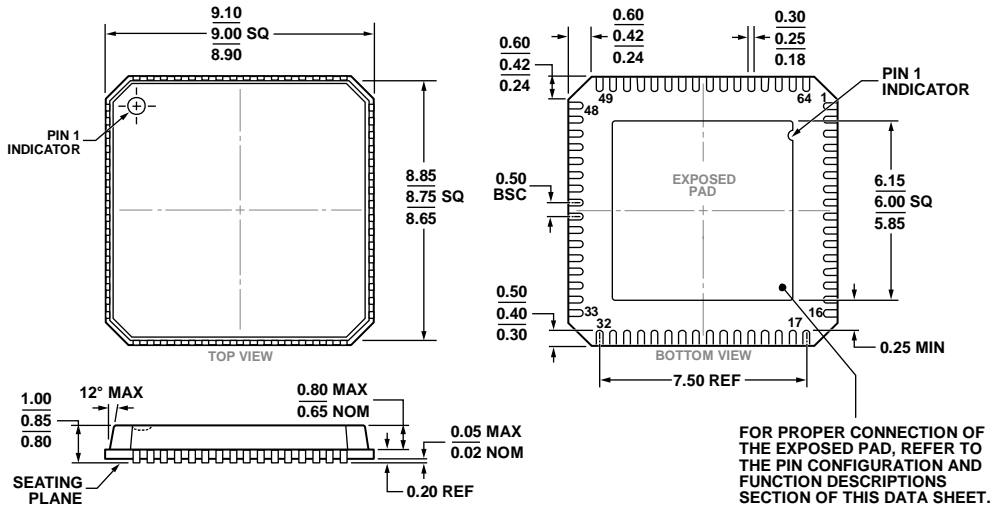

COMPLIANT TO JEDEC STANDARDS MO-220-VMM4

Figure 33. 64-Lead Lead Frame Chip Scale Package [LFCSP\_VQ]  
 9 mm × 9 mm Body, Very Thin Quad  
 (CP-64-2)  
 Dimensions shown in millimeters

ORDERING GUIDE

Model <sup>1</sup>	Temperature Range	Package Description	Package Option
ADN4600ACPZ	-40°C to +85°C	64-Lead Lead Frame Chip Scale Package [LFCSP_VQ]	CP-64-2
ADN4600ACPZ-R7	-40°C to +85°C	64-Lead Lead Frame Chip Scale Package [LFCSP_VQ]	CP-64-2
ADN4600-EVALZ		Evaluation Board	

<sup>1</sup> Z = RoHS Compliant Part.

Компания «Life Electronics» занимается поставками электронных компонентов импортного и отечественного производства от производителей и со складов крупных дистрибьюторов Европы, Америки и Азии.

С конца 2013 года компания активно расширяет линейку поставок компонентов по направлению коаксиальный кабель, кварцевые генераторы и конденсаторы (керамические, пленочные, электролитические), за счёт заключения дистрибьюторских договоров

Мы предлагаем:

- Конкуренеспособные цены и скидки постоянным клиентам.
- Специальные условия для постоянных клиентов.
- Подбор аналогов.
- Поставку компонентов в любых объемах, удовлетворяющих вашим потребностям.
- Приемлемые сроки поставки, возможна ускоренная поставка.
- Доставку товара в любую точку России и стран СНГ.
- Комплексную поставку.
- Работу по проектам и поставку образцов.
- Формирование склада под заказчика.
- Сертификаты соответствия на поставляемую продукцию (по желанию клиента).
- Тестирование поставляемой продукции.
- Поставку компонентов, требующих военную и космическую приемку.
- Входной контроль качества.
- Наличие сертификата ISO.

В составе нашей компании организован Конструкторский отдел, призванный помогать разработчикам, и инженерам.

Конструкторский отдел помогает осуществить:

- Регистрацию проекта у производителя компонентов.
- Техническую поддержку проекта.
- Защиту от снятия компонента с производства.
- Оценку стоимости проекта по компонентам.
- Изготовление тестовой платы монтаж и пусконаладочные работы.



Тел: +7 (812) 336 43 04 (многоканальный)

Email: [org@lifeelectronics.ru](mailto:org@lifeelectronics.ru)