



Features

- Incremental encoder / quadrature output
- Exceptionally long operating life
- High operating temperature capabilities - up to 125°C
- Sturdy construction
- Bushing mount
- Available with PC board mounting bracket (optional)

ECW - Digital Contacting Encoder

Electrical Characteristics

Output	2-bit gray code, Channel A leads Channel B by 90° electrically turning clockwise (CW)
Closed Circuit Resistance	5 ohms maximum
Open Circuit Resistance	100K ohms minimum
Contact Rating	10 milliamp @ 10 VDC or 0.1 watt maximum
Insulation Resistance (500 VDC)	1,000 megohms minimum
Dielectric Withstanding Voltage	MIL-STD-202 Method 301
Sea Level	1,000 VAC minimum
Electrical Travel	Continuous
Contact Bounce (15 RPM)	5 milliseconds maximum
RPM (Operating)	120 maximum

Environmental Characteristics

Storage Temperature Range	-40°C to +140°C
Operating Temperature Range	+1°C to +125°C
Humidity	MIL-STD-202, Method 103B, Condition B
Vibration	15G
Contact Bounce	0.1 millisecond maximum
Shock	50G
Contact Bounce	0.1 millisecond maximum
Rotational Life	200,000 shaft revolutions*

Mechanical Characteristics

Mechanical Angle	Continuous
Weight	Approximately 0.75 oz.
Torque (Detented)	0.75 to 2.25 oz-in.
Mounting Torque	7 in-lbs. maximum
Shaft Side Load (Static)	10 lbs. minimum

*Applies to EC Option.

QUADRATURE OUTPUT TABLE

This table is intended to show available outputs as currently defined.

1/4 CYCLE PER DETENT



FULL CYCLE PER DETENT (Normally Open in Detent Shown)



RECOMMENDED INCREMENTAL CONTROL DIAGRAM



DIGITAL CONTACTING

The Digital Contacting Encoder is commonly referred to by such names as Digital Panel Control, Bit Switch, Gray Switch and Digital Switch. All such names are synonymous with a device whose output is a digital gray code signal, rather than a conventional potentiometric voltage ratio output.

The advantage of the Digital Contacting Encoder is that it permits the direct entry of digitized analog data into a digital circuit without A/D

conversion. The two (2) channel gray coded signal of this incremental encoder allows the user's decoder circuit to sense analog direction of rotation, as well as up-down counter capabilities . . . all without the time and cost required for A/D conversion. This approach can reduce memory overhead, wiring and wiring interconnects, and can provide greater MPU program speed.

ECW - Digital Contacting Encoder

BOURNS®

BUSHING MOUNTED - HOUSING A

W style bushing shown.

Shaft lengths "L" for B, C, R and Y styles
 24 = .750" (19mm)
 36 = 1.125" (28.5mm)

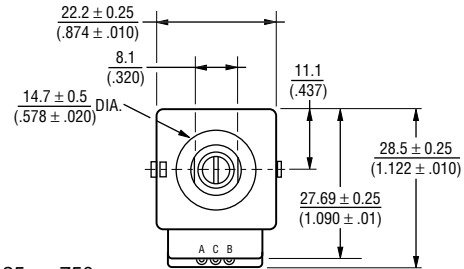
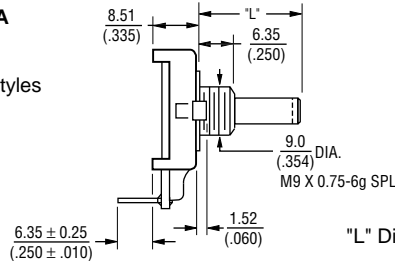

"L" Dim. = 1.125 or .750

PCB BRACKET MOUNTED - HOUSING B

Dimensions not given are the same as Bushing Mounted.



SOLDER HOLES - HOUSING C

Dimensions not given are the same as Bushing Mounted.



SNAP-IN MOUNT - Housing G

PCB MOUNTING DIMENSIONS

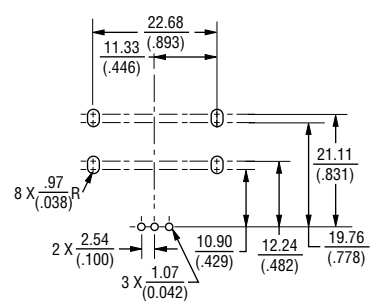

Shaft Style B

Shaft Style C

Shaft Style J

Shaft Style R

Shaft Style Y

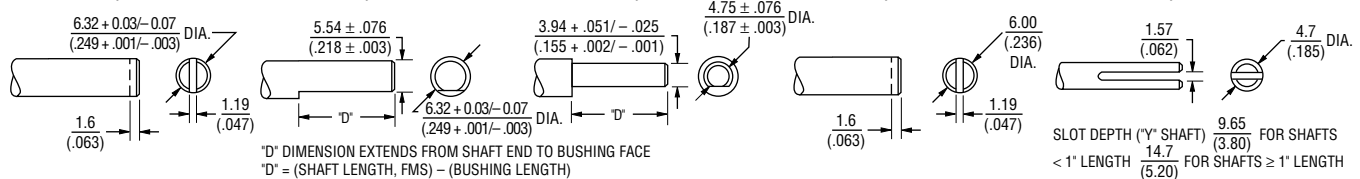

PANEL HOLE DIMENSIONS

Bushing Mounted

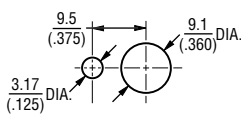

PCB MOUNTING DIMENSIONS

(Housing Styles B and E)

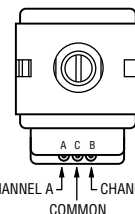
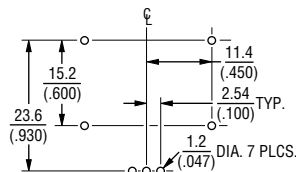

FOR TOLERANCES NOT SHOWN
 .XX = ± .010
 .XXX = ± .005
 SHAFT DIMENSIONS ± 1/32"

DIMENSIONS ARE: METRIC
 (INCHES)

ECW - Digital Contacting Encoder - How To Order



PART NUMBERING SYSTEM

E C W 1 J - B 2 4 - B C 0 0 2 4

Code	Rotational Life
C	200,000 Revolutions

BUSHING CONFIGURATION	
Code	Description
W	9mm x 1/4" Length. Threaded M9x0.75
L	9mm x 3/8" Length. Threaded M9x0.75 (Use B shaft only.)
T	9mm x 1/4". No Thread.

SWITCHING CONFIGURATION (In Detent Position)
Applies to performance codes B0012 and C0024 only, use code "0" for all other performance codes.

Code	Description
0	Not Applicable
1	Normally Open
2	Normally Closed

ANTI-ROTATION LUG POSITION	
Code	Description
J	9:00 Position
D	None

SHAFT STYLE (See Outline Drawing for Details)	
Code	Description
B	Plain with Inserted Slot (1/4" Dia.)
C	Single Flatted (1/4" Dia.)
R	Plain with Inserted Slot (6mm Dia.)
Y	Split Shaft Version (.185" Dia.)
J	Flatted Shaft (3/16" Dia.)

PERFORMANCE CODE		
Code	Detents	Cycles/Rev.
E0006		6
E0009		9
E0012	0	12
E0024		24
B0012	12	12
C0006		6
C0024	24	24
D0009	36	9

HOUSING TERMINAL CONFIGURATION (X indicates "Equipped With")

Features	Code						
	A	B	C	D	E	F	G*
Terminal Cover	X	X			X		X
Terminals	X	X			X		X
Solder Holes			X	X		X	
PCB Bracket		X		X	X	X	
Hardware Included	X		X		X	X	
Snap-In Mount							X

*Bushing code T only.

SHAFT LENGTH (FMS)

Code	Description	Available Shaft Styles
16	1/2" Length	B
20	5/8" (15.9mm) Length	J
24	3/4" (19mm) Length	B, C, J, Y
28	7/8" (22.2mm) Length	B, C, J, Y
32	1" (25.4mm) Length	B, C, J, Y
36	1-1/8" (28.6mm) Length	B, C, J, Y
Metric		
19	19mm Length	R
22	22mm Length	R
24	24mm Length	R

The sample part number demonstrates the identification code for Bourns contacting encoders. The part number shown is a commonly used model, typically available from stock.

Компания «Life Electronics» занимается поставками электронных компонентов импортного и отечественного производства от производителей и со складов крупных дистрибьюторов Европы, Америки и Азии.

С конца 2013 года компания активно расширяет линейку поставок компонентов по направлению коаксиальный кабель, кварцевые генераторы и конденсаторы (керамические, пленочные, электролитические), за счёт заключения дистрибьюторских договоров

Мы предлагаем:

- Конкурентоспособные цены и скидки постоянным клиентам.
- Специальные условия для постоянных клиентов.
- Подбор аналогов.
- Поставку компонентов в любых объемах, удовлетворяющих вашим потребностям.
- Приемлемые сроки поставки, возможна ускоренная поставка.
- Доставку товара в любую точку России и стран СНГ.
- Комплексную поставку.
- Работу по проектам и поставку образцов.
- Формирование склада под заказчика.
- Сертификаты соответствия на поставляемую продукцию (по желанию клиента).
- Тестирование поставляемой продукции.
- Поставку компонентов, требующих военную и космическую приемку.
- Входной контроль качества.
- Наличие сертификата ISO.

В составе нашей компании организован Конструкторский отдел, призванный помогать разработчикам, и инженерам.

Конструкторский отдел помогает осуществить:

- Регистрацию проекта у производителя компонентов.
- Техническую поддержку проекта.
- Защиту от снятия компонента с производства.
- Оценку стоимости проекта по компонентам.
- Изготовление тестовой платы монтаж и пусконаладочные работы.



Тел: +7 (812) 336 43 04 (многоканальный)

Email: org@lifeelectronics.ru