



Main

| | |
|-------------------------------|------------------------------|
| Range of product | Harmony XB5 |
| Product or component type | Head for key selector switch |
| Device short name | ZB5 |
| Bezel material | Plastic |
| Mounting diameter | 0.87 in (22 mm) |
| Head type | Standard |
| Sale per indivisible quantity | 1 |
| Shape of signaling unit head | Round |
| Type of operator | Stay put |
| Operator profile | Black key switch |
| Operator position information | 3 positions +/- 45° |
| Type of keylock | Dom 8D1 |
| Key withdrawal position | In any position |

Complementary

| | |
|-----------------------------|--|
| CAD overall width | 1.14 in (29 mm) |
| CAD overall height | 1.14 in (29 mm) |
| CAD overall depth | 2.83 in (72 mm) |
| Product weight | 0.13 lb(US) (0.057 kg) |
| Mechanical durability | 1000000 cycles |
| Station name | XALD 1...5 cut-outs XALK 2...5 cut-outs |
| Electrical composition code | C11 for 3 contacts using single blocks in front mounting SF1 for 3 contacts using single blocks in front mounting C7 for 4 contacts using single blocks in front mounting C8 for 4 contacts using single and double blocks in front mounting SR1 for 3 contacts using single blocks in rear mounting C4 6 contacts using single and double blocks in front mounting C5 for 5 contacts using single blocks in front mounting C6 for 5 contacts using single and double blocks in front mounting C3 6 contacts using single blocks in front mounting |

Environment

| | |
|---------------------------------------|---|
| protective treatment | TH |
| ambient air temperature for storage | -40...158 °F (-40...70 °C) |
| ambient air temperature for operation | -40...158 °F (-40...70 °C) |
| overvoltage category | Class II conforming to IEC 60536 |
| IP degree of protection | IP67 IP66 conforming to IEC 60529 IP69K IP69 |
| NEMA degree of protection | NEMA 13 NEMA 4X |
| resistance to high pressure washer | 1015.26 psi (7000000 Pa) at 131 °F (55 °C), distance: 0.1 m |
| IK degree of protection | IK06 conforming to IEC 50102 |
| standards | EN/IEC 60947-1 EN/IEC 60947-5-1 EN/IEC 60947-5-4 JIS C 4520 UL 508 CSA C22.2 No 14 |
| product certifications | BV CSA DNV |

The information provided in this documentation contains general descriptions and/or technical characteristics of the performance of the products contained herein. This documentation is not intended as a substitute for and is not to be used for determining suitability or reliability of these products for specific user applications. It is the duty of any such user or integrator to perform the appropriate and complete risk analysis, evaluation and testing of the products with respect to the relevant specific application or use thereof. Neither Schneider Electric Industries SAS nor any of its affiliates or subsidiaries shall be responsible or liable for misuse of the information contained herein.

GL
LROS (Lloyds register of shipping)
RINA
UL listed

| | |
|----------------------|--|
| vibration resistance | 5 gn (f = 2...500 Hz) conforming to IEC 60068-2-6 |
| shock resistance | 30 gn (duration = 18 ms) half sine wave acceleration conforming to IEC 60068-2-27 50 gn (duration = 11 ms) half sine wave acceleration conforming to IEC 60068-2-27 |

Offer Sustainability

| | |
|--|--|
| WARNING: This product can expose you to chemicals including: | WARNING: This product can expose you to chemicals including: |
| Nickel compounds, which is known to the State of California to cause cancer, and | Nickel compounds, which is known to the State of California to cause cancer, and |
| Di-isodecyl phthalate (DIDP), which is known to the State of California to cause birth defects or other reproductive harm. | Di-isodecyl phthalate (DIDP), which is known to the State of California to cause birth defects or other reproductive harm. |
| For more information go to www.p65warnings.ca.gov | For more information go to www.p65warnings.ca.gov |

Contractual warranty

| | |
|-----------------|-----------|
| Warranty period | 18 months |
|-----------------|-----------|

Dimensions

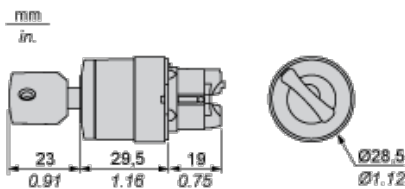

Panel Cut-out for Pushbuttons, Switches and Pilot Lights (Finished Holes, Ready for Installation)

Connection by Screw Clamp Terminals or Plug-in Connectors or on Printed Circuit Board

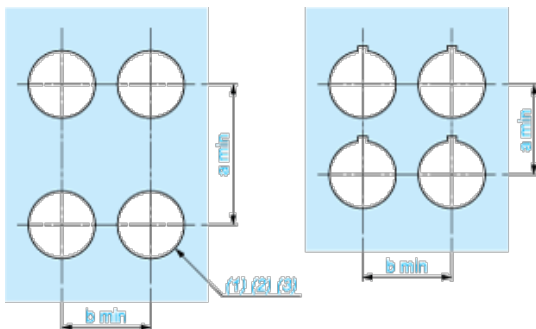

- (1) Diameter on finished panel or support
- (2) For selector switches and Emergency stop buttons, use of an anti-rotation plate type ZB5AZ902 is recommended.
- (3) $\varnothing 22.5$ mm recommended ($\varnothing 22.3^{+0.4}$) / $\varnothing 0.89$ in. recommended ($\varnothing 0.88$ in. $^{+0.016}$)

| Connections | a in mm | a in in. | b in mm | b in in. |
|---|---------|----------|---------|----------|
| By screw clamp terminals or plug-in connector | 40 | 1.57 | 30 | 1.18 |
| By Faston connectors | 45 | 1.77 | 32 | 1.26 |
| On printed circuit board | 30 | 1.18 | 30 | 1.18 |

Detail of Lug Recess

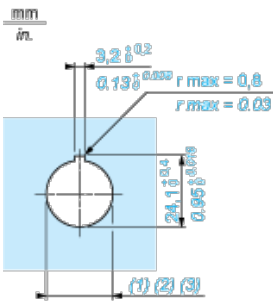

- (1) Diameter on finished panel or support
- (2) For selector switches and Emergency stop buttons, use of an anti-rotation plate type ZB5AZ902 is recommended.
- (3) $\varnothing 22.5$ mm recommended ($\varnothing 22.3_{+0.4}$) / $\varnothing 0.89$ in. recommended ($\varnothing 0.88$ in. $_{+0.016}$)

Pushbuttons, Switches and Pilot Lights for Printed Circuit Board Connection

Panel Cut-outs (Viewed from Installer's Side)

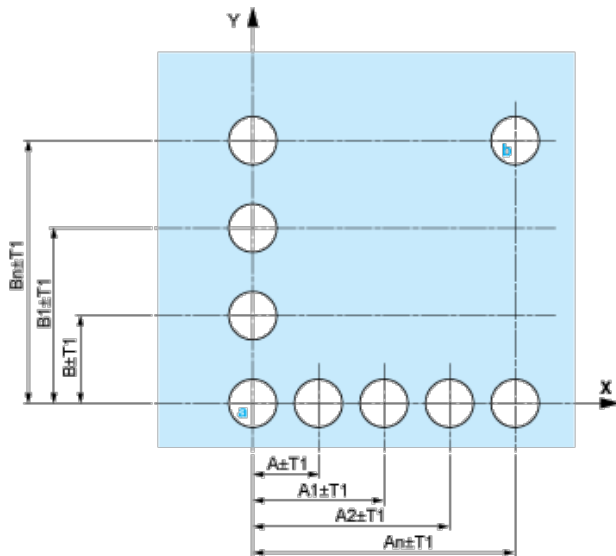

- A: 30 mm min. / 1.18 in. min.
- B: 40 mm min. / 1.57 in. min.

Printed Circuit Board Cut-outs (Viewed from Electrical Block Side)

Dimensions in mm

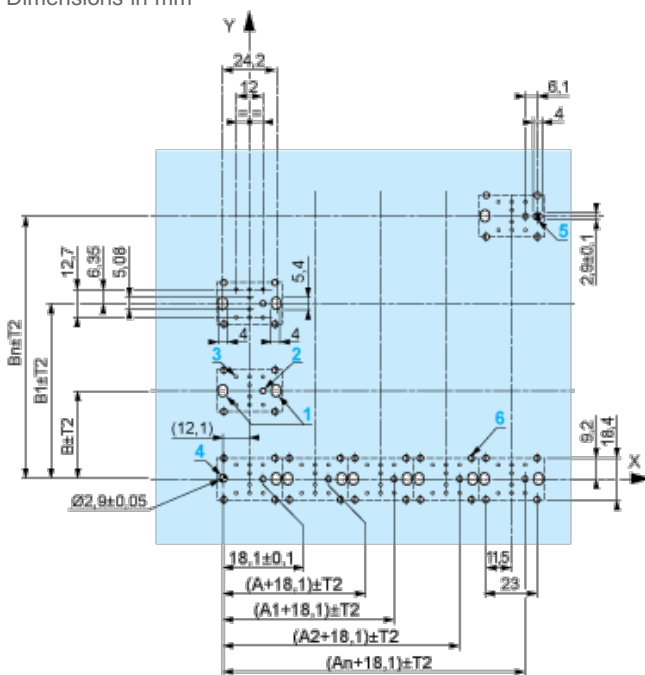

- A: 30 mm min.
- B: 40 mm min.

Dimensions in in.



A: 1.18 in. min.

B: 1.57 in. min.

General Tolerances of the Panel and Printed Circuit Board

The cumulative tolerance must not exceed 0.3 mm / 0.012 in.: $T1 + T2 = 0.3 \text{ mm max.}$

Installation Precautions

- | Minimum thickness of circuit board: 1.6 mm / 0.06 in.
- | Cut-out diameter: 22.4 mm \pm 0.1 / 0.88 in. \pm 0.004
- | Orientation of body/fixing collar ZB5AZ009: \pm 2°30' (excluding cut-outs marked **a** and **b**).
- | Tightening torque of screws ZBZ006: 0.6 N.m (5.3 lbf.in) max.
- | Allow for one ZB5AZ079 fixing collar/pillar and its fixing screws:
 - | every 90 mm / 3.54 in. horizontally (X), and 120 mm / 4.72 in. vertically (Y).
 - | with each selector switch head (ZB5AD•, ZB5AJ•, ZB5AG•).

The fixing centers marked **a** and **b** are diagonally opposed and must align with those marked **4** and **5**.



- (1) Head ZB5AD•
- (2) Panel
- (2) Nut
- (4) Printed circuit board

Mounting of Adapter (Socket) ZBZ01•

- | 1 2 elongated holes for ZBZ006 screw access
- | 2 1 hole \varnothing 2.4 mm \pm 0.05 / 0.09 in. \pm 0.002 for centring adapter ZBZ01•
- | 3 8 \times \varnothing 1.2 mm / 0.05 in. holes
- | 4 1 hole \varnothing 2.9 mm \pm 0.05 / 0.11 in. \pm 0.002, for aligning the printed circuit board (with cut-out marked **a**)

- | 5 1 elongated hole for aligning the printed circuit board (with cut-out marked **b**)
- | 6 4 holes \varnothing 2.4 mm / 0.09 in. for clipping in adapter ZBZ01•

Dimensions An + 18.1 relate to the \varnothing 2.4 mm \pm 0.05 / 0.09 in. \pm 0.002 holes for centring adapter ZBZ01•.

Electrical Composition Corresponding to Code C4



Electrical Composition Corresponding to Code C5



Electrical Composition Corresponding to Code C6



Electrical Composition Corresponding to Code C7

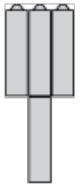

Electrical Composition Corresponding to Code C8

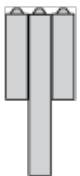

Electrical Composition Corresponding to Code C3



Electrical Composition Corresponding to Codes C9, C11, SF1 and SR1



Legend

Single contact



Double contact



Light block



Possible location



Sequence of Contacts Fitted to 3-position Selector Switch Body





Position 315°



| | | | | | |
|-----------------|----------|--------|--------|--------|-------|
| Push | Position | Top | | | |
| | | Bottom | | | |
| | Location | | Left | Centre | Right |
| | State | | 1 | 1 | 0 |
| Contacts | N/O | closed | closed | open | |
| | N/C | open | open | closed | |



Position 0°



| | | | | | |
|-----------------|----------|--------|---|---|---|
| Push | Position | Top |  | | |
| | | Bottom |  |  |  |
| | Location | | Left | Centre | Right |
| | State | | 0 | 0 | 0 |
| Contacts | N/O | | open | open | open |
| | N/C | | closed | closed | closed |

Position 45°



| | | | | | |
|-----------------|----------|--------|---|---|--------|
| Push | Position | Top |  | | |
| | | Bottom |  |  | |
| | Location | | Left | Centre | Right |
| | State | | 0 | 1 | 1 |
| Contacts | N/O | | open | closed | closed |
| | N/C | | closed | open | open |

Компания «Life Electronics» занимается поставками электронных компонентов импортного и отечественного производства от производителей и со складов крупных дистрибьюторов Европы, Америки и Азии.

С конца 2013 года компания активно расширяет линейку поставок компонентов по направлению коаксиальный кабель, кварцевые генераторы и конденсаторы (керамические, пленочные, электролитические), за счёт заключения дистрибьюторских договоров

Мы предлагаем:

- Конкурентоспособные цены и скидки постоянным клиентам.
- Специальные условия для постоянных клиентов.
- Подбор аналогов.
- Поставку компонентов в любых объемах, удовлетворяющих вашим потребностям.
- Приемлемые сроки поставки, возможна ускоренная поставка.
- Доставку товара в любую точку России и стран СНГ.
- Комплексную поставку.
- Работу по проектам и поставку образцов.
- Формирование склада под заказчика.
- Сертификаты соответствия на поставляемую продукцию (по желанию клиента).
- Тестирование поставляемой продукции.
- Поставку компонентов, требующих военную и космическую приемку.
- Входной контроль качества.
- Наличие сертификата ISO.

В составе нашей компании организован Конструкторский отдел, призванный помогать разработчикам, и инженерам.

Конструкторский отдел помогает осуществить:

- Регистрацию проекта у производителя компонентов.
- Техническую поддержку проекта.
- Защиту от снятия компонента с производства.
- Оценку стоимости проекта по компонентам.
- Изготовление тестовой платы монтаж и пусконаладочные работы.



Тел: +7 (812) 336 43 04 (многоканальный)

Email: org@lifeelectronics.ru